

Hardware User Manual

EVAL-BF5xx V5.x

DEV-BF5xxDA-lite V5.x

...maximum performance at minimum space

Contact

Bluetechnix Mechatronische Systeme GmbH

Waidhausenstraße 3/19

A-1140 Vienna

AUSTRIA/EUROPE

office@bluetechnix.at

<http://www.bluetechnix.com>

Document No.: 100-2345-1.1

Document Revision 15

2012-01-30

Table of Contents

Table of Contents.....	2
BLACKFIN Products	5
BLACKFIN Design Service.....	6
1 Introduction	7
1.1 Overview.....	7
2 Functional Specification.....	9
2.1 Power connector and Power supply.....	9
3 PCB Placement and Mechanical Outline.....	10
3.1 PCB Placement	10
3.2 Mechanical Outline.....	11
3.3 Extender Footprint.....	12
4 Connector Description.....	13
4.1 X1 –RJ45 Ethernet Connector.....	13
4.2 X2 –SD-Card Connector (bottom mount).....	13
4.3 X3 – JTAG Bypass Connector	13
4.4 X4, X6, X9 – USB Connectors.....	13
4.5 X5 UART Expansion Pads.....	13
4.6 X7, X8 Expansion Connectors.....	14
4.7 X10 – CAN Connector	14
4.8 X11 – Power Connector	14
4.9 X8 – Expansion Connector 1	15
4.10 X7 – Expansion Connector 2	17
5 Switches, Jumper and LED Description.....	19
5.1 S1 Ethernet Switch for the CM-BF527and the CM-BF537E	19
5.2 S2 Core Module Configuration	19
5.2.1 SD-Card CS and USB VBUS	19
5.2.2 CAN	19
5.3 S4 – UART Switch.....	19
5.4 JP1 - Power Supply Jumper	20
5.5 JP2 – RTC Power Jumper	20
5.6 JP3	20
5.7 JP6 USB-ID.....	20
5.8 Buttons S3, S6	20
5.9 General Purpose LEDs	20
5.10 Ethernet LEDs.....	20

5.11	LEDs of the Debug Agent.....	21
6	Boot Mode Description.....	21
7	Using a Core Module with on board USB	23
8	Installation	23
8.1	Initial Board Setup.....	23
8.2	Debug Agent Setup (Only for DEV-BF5xxDA-Lite)	26
9	Using the VDSP Flash Programming Tool	30
9.1	Developing an Application.....	30
9.2	Overwriting BLACKSheep Code.....	30
10	Extender Board Compatibility List.....	30
10.1	Without an Extender Board	31
10.2	Experimental Extender Board.....	31
10.3	Video Extender Board	31
10.4	Audio Extender Board	31
10.5	Camera Extender Board	31
10.6	Analog-Digital / Digital-Analog Converter Extender Board	32
10.7	USB-ETH Extender Board	32
10.8	Video and Audio Extender Board.....	32
10.9	Camera and Audio Extender Board.....	32
11	Anomalies	32
12	Document Revision History.....	33
A	List of Figures and Tables.....	33

© Bluetechnix Mechatronische Systeme GmbH 2011

All Rights Reserved.

The information herein is given to describe certain components and shall not be considered as a guarantee of characteristics.

Terms of delivery and rights of technical change reserved.

We hereby disclaim any warranties, including but not limited to warranties of non-infringement, regarding circuits, descriptions and charts stated herein.

Bluetechnix makes and you receive no warranties or conditions, express, implied, statutory or in any communication with you. Bluetechnix specifically disclaims any implied warranty of merchantability or fitness for a particular purpose.

Bluetechnix takes no liability for any damages and errors causing of the usage of this board. The user of this board is responsible by himself for the functionality of his application. He is allowed to use the board only if he has the qualification. More information is found in the General Terms and Conditions (AGB).

Information

For further information on technology, delivery terms and conditions and prices please contact Bluetechnix (<http://www.bluetechnix.com>).

Warning

Due to technical requirements components may contain dangerous substances.

BLACKFIN Products

Core Modules:

TCM-BF518:	The new Core Module CM-BF518 is powered by Analog Devices' single core ADSP-BF518 processor; up to 400MHz, 32MB SDRAM, up to 8MB flash. The 2x60 pin expansion connectors are backwards compatible with other Core Modules.
CM-BF527:	The new Blackfin Processor Module is powered by Analog Devices' single core ADSP-BF527 processor; key features are USB OTG 2.0 and Ethernet. The 2x60 pin expansion connectors are backwards compatible with other Core Modules.
CM-BF533:	Blackfin Processor Module powered by Analog Devices' single core ADSP-BF533 processor; up to 600MHz, 32MB SDRAM, 2MB flash, 2x60 pin expansion connectors and a size of 36.5x31.5mm.
TCM-BF537:	Blackfin Processor Module powered by Analog Devices' single core ADSP-BF537 processor; up to 500MHz, 32MB SDRAM, 8MB flash, a size of 28x28mm, 2x60 pin expansion connectors, Ball Grid Array or Border Pads for reflow soldering, industrial temperature range -40°C to +85°C.
CM-BF537E:	Blackfin Processor Module powered by Analog Devices' single core ADSP-BF537 processor; up to 600MHz, 32MB SDRAM, 4MB flash, integrated TP10/100 Ethernet physical transceiver, 2x60 pin expansion connectors and a size of 36.5x31.5mm.
CM-BF537U:	Blackfin Processor Module powered by Analog Devices' single core ADSP-BF537 processor; up to 600MHz, 32MB SDRAM, 4MB flash, integrated USB 2.0 Device, 2x60 pin expansion connectors and a size of 36.5x31.5mm.
CM-BF548:	The new Blackfin Processor Module is powered by Analog Devices' single core ADSP-BF548 processor; key features are 64MB DDR SD-RAM 2x100 pin expansion connectors.
CM-BF561:	Blackfin Processor Module powered by Analog Devices' dual core ADSP-BF561 processor; up to 2x 600MHz, 64MB SDRAM, 8MB flash, 2x60 pin expansion connectors and a size of 36.5x31.5mm.
eCM-BF561:	Blackfin Processor Module powered by Analog Devices' dual core ADSP-BF561 processor; up to 2x 600MHz, 128MB SDRAM, 8MB flash, 2x100 pin expansion connectors and a size of 44x33mm.

Development Boards:

- EVAL-BF5xx:** Low cost Blackfin processor Evaluation Board with one socket for any Bluetechnix Blackfin Core Module. Additional interfaces are available, e.g. an SD-Card.
- DEV-BF5xxDA-Lite:** Get ready to program and debug Bluetechnix Core Modules with this tiny development platform including an USB-Based Debug Agent. The DEV-BF5xxDA-Lite is a low cost starter development system including a VDSP++ Evaluation Software License.
- DEV-BF548-Lite:** Low-cost development board with one socket for Bluetechnix CM-BF548 Core Module. Additional interfaces are available, e.g. an SD-Card, USB and Ethernet.
- DEV-BF548DA-Lite:** Get ready to program and debug Bluetechnix CM-BF548 Core Module with this tiny development platform including an USB-Based Debug Agent. The DEV-BF548DA-Lite is a low-cost starter development system including a VDSP++ Evaluation Software License.
- EXT-Boards:** The following Extender Boards are available: EXT-BF5xx-AUDIO, EXT-BF5xx-VIDEO, EXT-BF5xx-CAM, EXT-BF5xx-EXP-TR, EXT-BF5xx-USB-ETH2, EXT-BF5xx-AD/DA, EXT-BF548-EXP and EXT-BF518-ETH. Furthermore, we offer the development of customized extender boards for our customers.

Software Support:

- BLACKSheep:** The BLACKSheep VDK is a multithreaded framework for the Blackfin processor family from Analog Devices that includes driver support for a variety of hardware extensions. It is based on the real-time VDK kernel included within the VDSP++ development environment.
- LabVIEW:** LabVIEW embedded support for Bluetechnix Core Modules is done by Schmid-Engineering AG: <http://www.schmid-engineering.ch>
- uClinux:** All the Core Modules are fully supported by uClinux. The required boot loader and uClinux can be downloaded from: <http://blackfin.uClinux.org>.

Upcoming Products and Software Releases:

Keep up-to-date with all the changes to the Bluetechnix product line and software updates at: <http://www.bluetechnix.com>.

BLACKFIN Design Service

Based on more than five years of experience with Blackfin, Bluetechnix offers development assistance as well as custom design services and software development.

1 Introduction

NOTE: The DEV-BF5xxDA-Lite has an on-board Debug Agent, which is not available on the EVAL-BF5xx Board. All other features are identical! In this document, when describing both boards, the name DEV-BF5xx-Lite is used.

The DEV-BF5xx-Lite Board is a lightweight development platform for all current and future Bluetechnix Core Modules (CM-BF527, CM-BF533, CM-BF561, CM-BF537U, CM-BF537E, TCM-BF537, TCM-BF518). On the DEV-BF5xxDA-Lite board a bottom mounted tiny high performance Debug Agent fully compatible with Visual DSP++ allows programming and debugging any of the Blackfin Processors. The small baseboard has all hardware necessary to test the performance of the Core Modules including a high-speed serial port directly connectable to a computer USB port, a CAN Interface and an SD-Card mass storage device socket.

1.1 Overview

The DEV-BF5xx-Lite Board includes the following components:

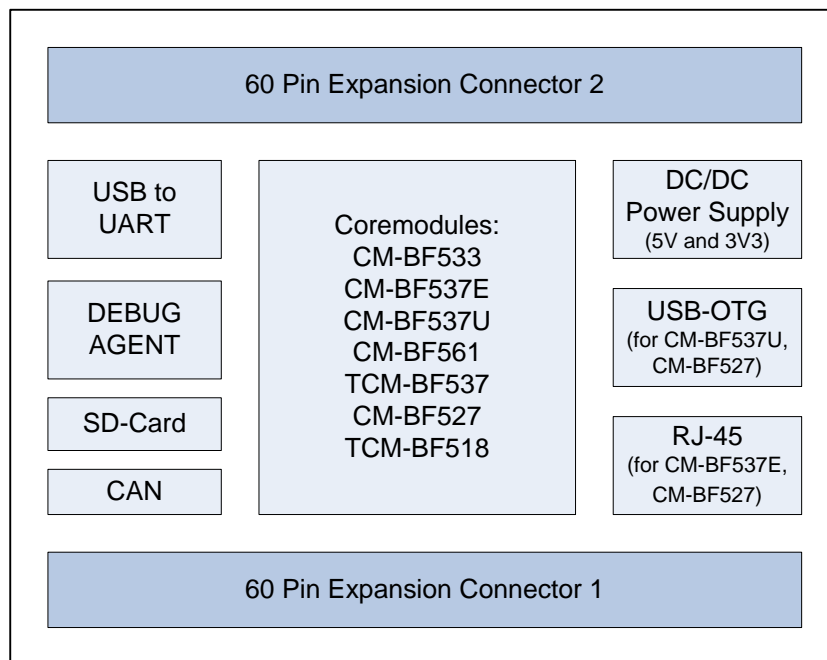

Figure 1-1: Overview of the Dev-BF5xx-Lite Board

- **DC/DC Converters**
 - 5V@2A + 3V3@1.5A (draws its power from the 5V output of the DC/DC)
- **1 Core Module Slot**
 - Supports all current Bluetechnix Blackfin based Core Modules

- **USB**
 - Supports up to 915kbps UART-USB conversion.
 - Emulates a standard COM port on the computer.
 - Drivers for Windows and Linux available
- **JTAG**
 - JTAG-Plug that supports all analog Devices JTAG Emulators.
- **Expansion Connector 1**
 - SPORT 0
 - UART
 - SPI
 - PPI1 (Parallel Port Interface 1)
 - PFs (Programmable Flags)
- **Expansion Connector 2**
 - Data Bus
 - Address Bus
 - Memory Control Signals
 - PPI2¹ (Parallel Port Interface 2)
 - Power Supply
- **2nd USB Connector (optional)**
 - Can only be used together with the CM-BF527 including USB2.0 OTG interface or the CM-BF537U Core Module which has an on-board NETPLX 2272 USB2.0 Device Chip.
- **RJ-45 Ethernet Plug**
 - Only in combination with the CM-BF527 and the CM-BF537E module
 - Standard 10BaseT/100BaseT Ethernet connection
- **External Power Supply**
 - The board is shipped with a 12V, 2A external DC/DC Power Supply

¹ Only available when using the CM-BF561 Core Module

2 Functional Specification

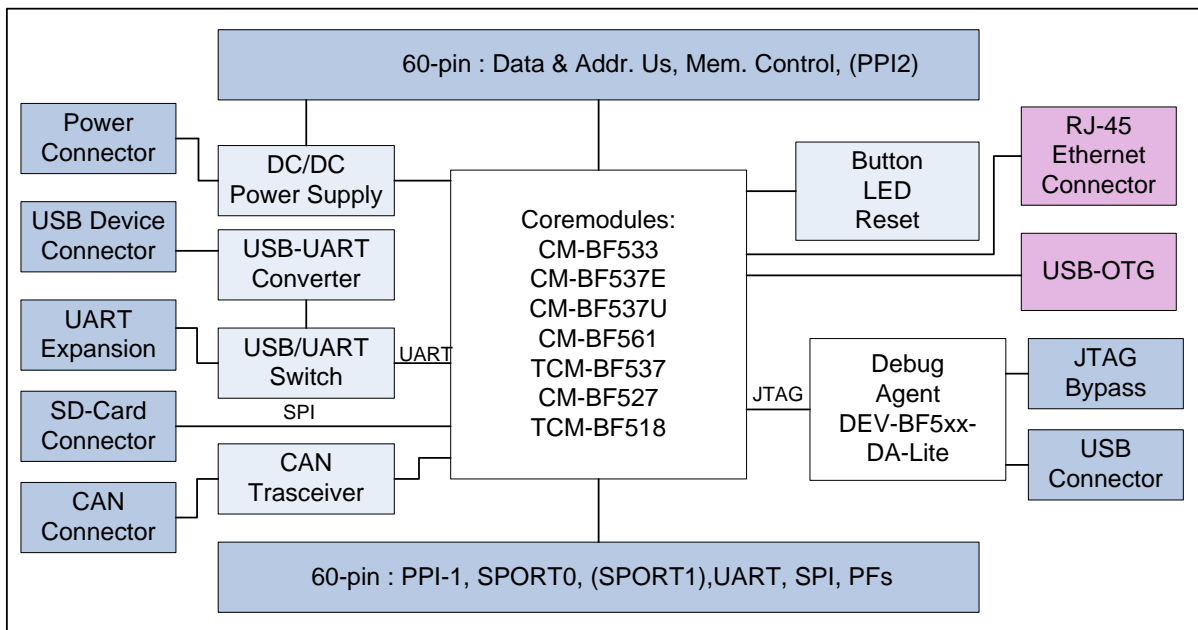

Figure 2-1: Block Diagram

Figure 2-1 shows a detailed block diagram of the Dev-BF5xx-Lite Board.

2.1 Power connector and Power supply

The supplied power supply should be used. It can deliver up to 1.25A at 12V.

The input voltage range of an alternative power supply must be within 6-16V and provide at least 9W!

The on-board DC/DC power supply generates 5V and 3.3V which are made available on the expansion connectors. The maximum current that can be drawn from the 5V is 2A, but take care as this includes the current going into the 3.3V regulator also, because this regulator is powered by the 5V. The maximum current that can be drawn from the 3.3V is 1.5A but note that this means at least 1A additional load on the 5V connector.

The serial port of the Core Module can be routed directly to the *USB Port (USB/UART)* or to the *UART Expansion Pads*.

An *SD-Card connector* mounted at the bottom of the board allows making use of file IO functions delivered with the BLACKSheep software. BLACKSheep supports SD-Cards and includes a FAT file system as well as the most relevant file IO functions. The complete BLACKSheep software package can be purchased from Bluetechnix.

The 2nd USB device connector (colored in purple) can only be used with the CM-BF527 Core Module featuring USB2.0 OTG and the CM-BF537U Core Module which has an on-board USB V2.0 Device (NET2272 by PLX-technology).

The RJ-45 Ethernet connector (colored in purple) can only be used in combination with the CM-BF527 or the CM-BF537E Core Module which has an on-board Ethernet physical chip.

3 PCB Placement and Mechanical Outline

3.1 PCB Placement

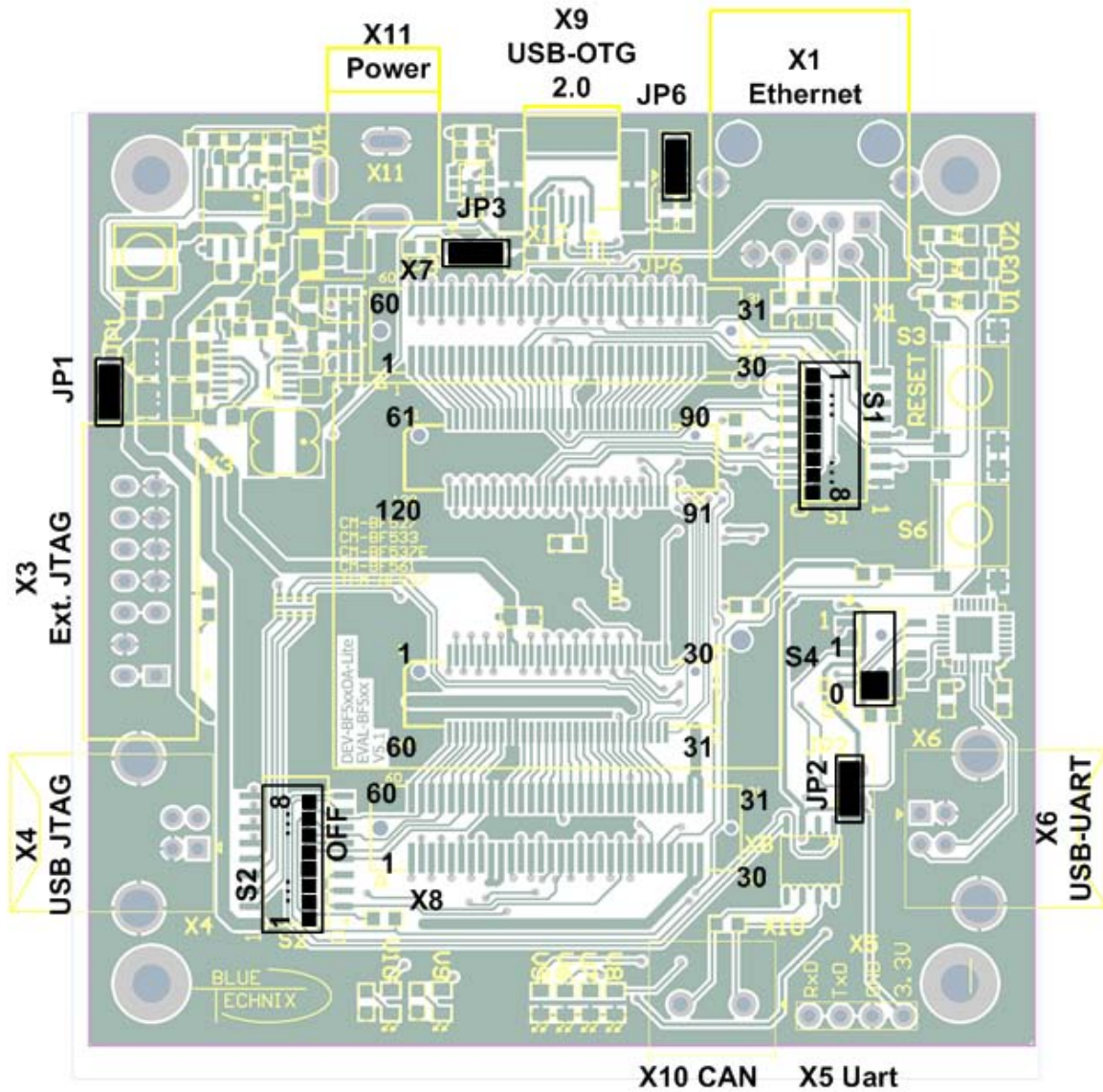

Figure 3-1: Connector PCB Placement

3.2 Mechanical Outline

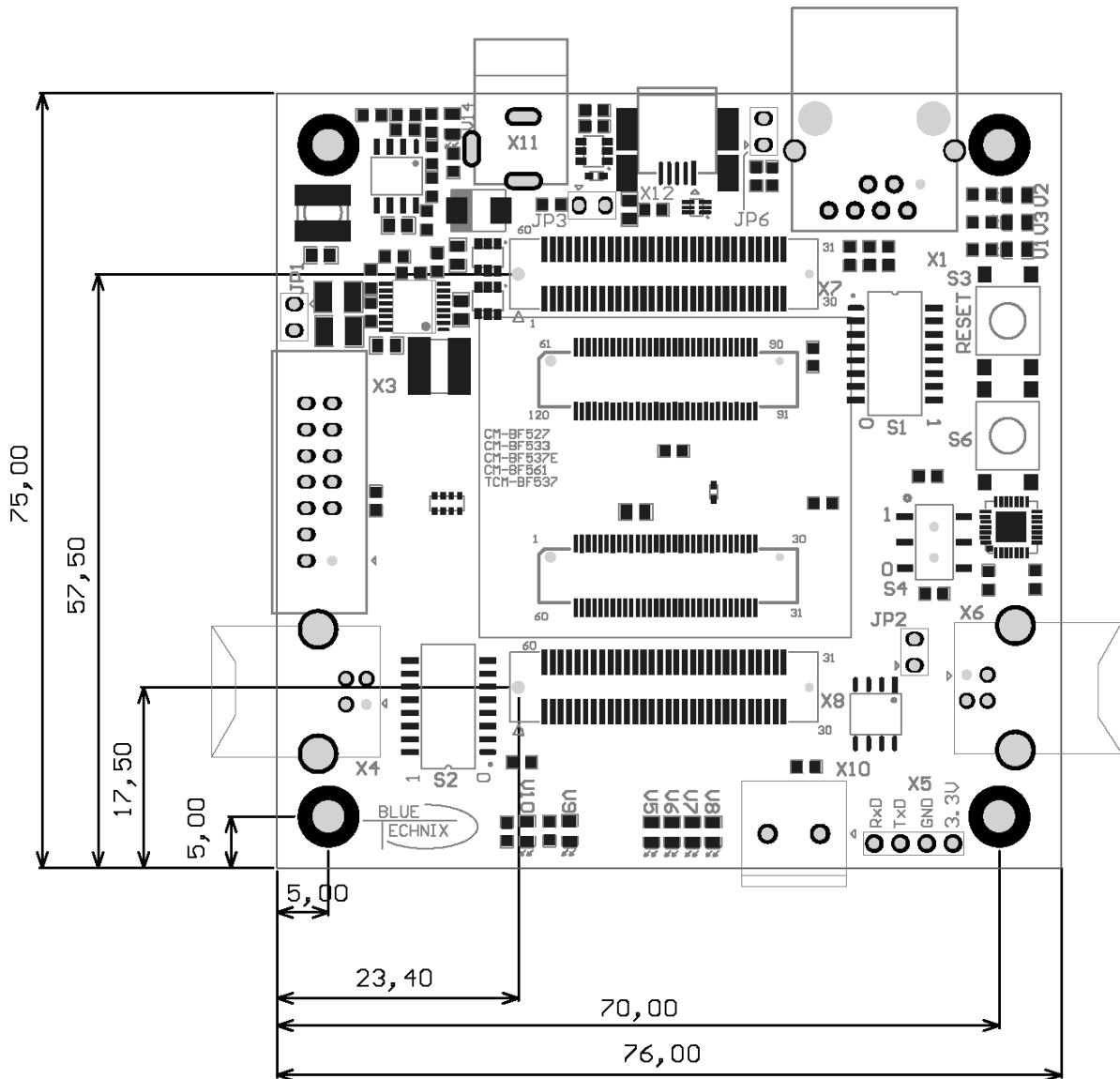

Figure 3-2: Mechanical Outline – Expansion Connector Placement (**top view**)

3.3 Extender Footprint

If you want to design your own Extension Board for the DEV-BF5xxDA-Lite, you can use the following Board dimensions (Figure 3-3).

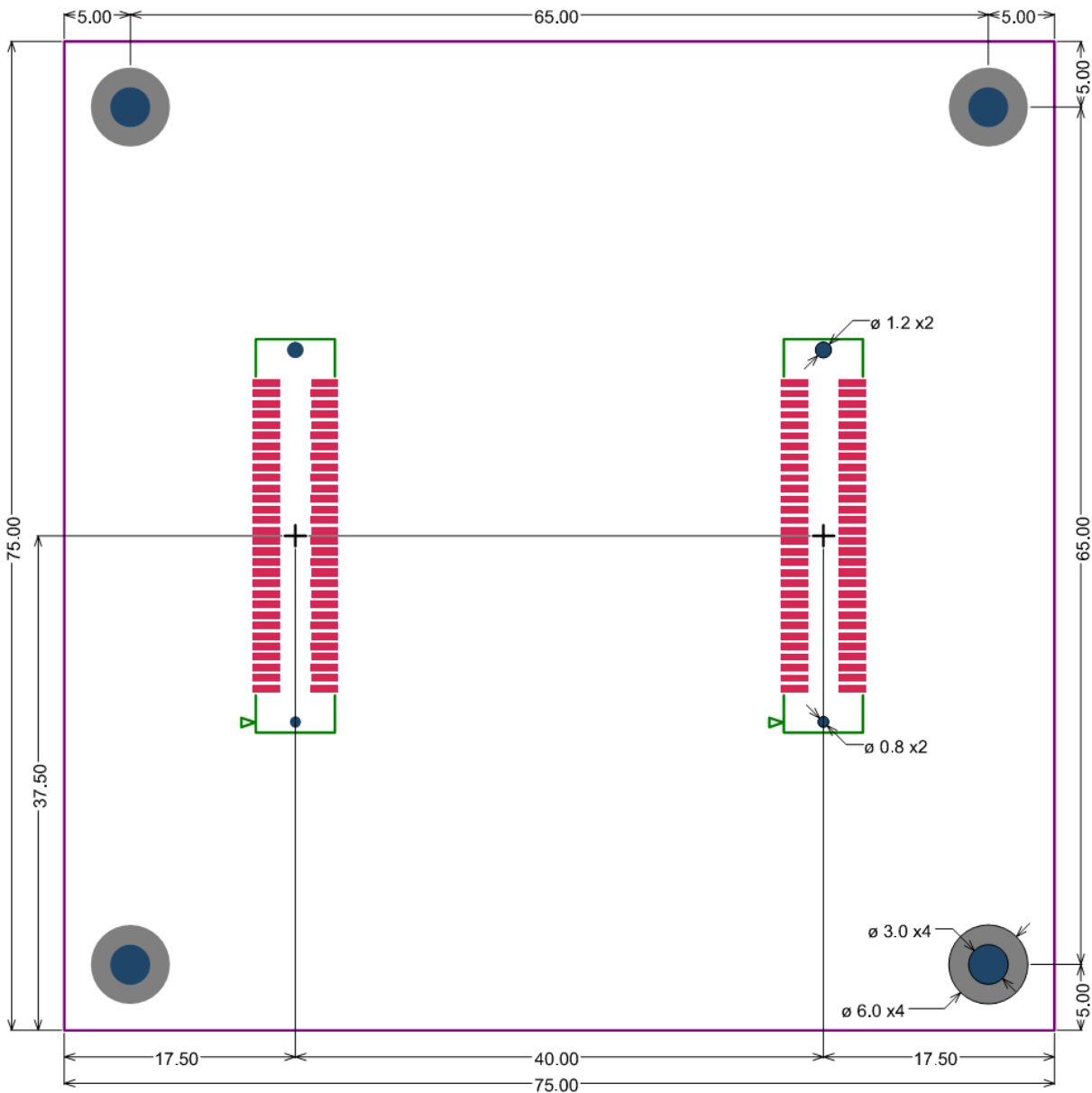

Figure 3-3: Recommended Footprint for Extension Boards (top view)

4 Connector Description

In the following the connectors shown in section 3.1 are described.

4.1 X1 –RJ45 Ethernet Connector

Pin No.	Signal (Core Module)	Description
1	TX+	O
2	TX-	O
3	RX+	I
4	NC	-
5	NC	-
6	RX-	I
7	NC	-
8	NC	-

Table 4-1: Ethernet Connector

4.2 X2 –SD-Card Connector (bottom mount)

Pin No.	Signal (Core Module)	Description (SD Card)
0	-	DAT2
1	nCS_SD_5xx (Pin 22 or 55)	CD/DAT3
2	MOSI (Pin 24)	CMD
3	GND	VSS1
4	3,3V	VDD
5	SPICLK (Pin 25)	CLK
6	GND	VSS2
7	MISO (Pin 37)	DAT0
8	-	DAT1
9	-	CD
10	-	WP

Table 4-2: SD-Card Connector

4.3 X3 – JTAG Bypass Connector

The JTAG connector is compliant with any Blackfin JTAG Emulator from Analog Devices. When an external JTAG emulator is attached the on-board JTAG is bypassed and the external one is automatically used.

4.4 X4, X6, X9 – USB Connectors

- X4 is a standard USB-B Device Connector for the DEBUG AGENT PC Interface
- X6 is a standard USB-B Device Connector for the USB to UART converter
- X9 is a standard USB 2.0 OTG Device Connector for the USB versions of the Core Modules

4.5 X5 UART Expansion Pads

When S4 is at position 1 the UART0 (TX, RX) is brought to the expansion pins and disconnected from the USB-UART Chip.

Pin No.	Signal	Signal Type
1	RxD Blackfin	Input Core Module
2	TxD Blackfin	Output Core Module
3	GND	
4	3V3	Regulated Power

Table 4-3: UART Connector

4.6 X7, X8 Expansion Connectors

The Expansion Connectors on the Dev-BF5xxDA-Lite for a stacked height of 16mm are of the following type:

Part	Manufacturer	Manufacturer Part Nr.
X7, X8	AMP (Stacked Height = 16mm)	5-5179010-2

Table 4-4: DEV-board connector types

The matching connector, which is used for building an extender board, can be ordered from Bluetechnix.

Part	Manufacturer	Manufacturer Part Nr.
Matching connector	AMP	5179031-2

Table 4-5: DEV-board matching connector types

4.7 X10 – CAN Connector

Pin No.	Signal (Core Module)	Signal Type
1	CAN+	I/O
2	CAN-	I/O

Table 4-6: CAN Connector

4.8 X11 – Power Connector

The board is shipped with a 12V, 2A external DC/DC Power Supply which should be used.

Pin No.	Signal	Description
1	Vin (+6V to +16V DC) Input Supply	Preferable 12V DC (1-2A)
2	NC	
3	GND	

Table 4-7: Power Supply

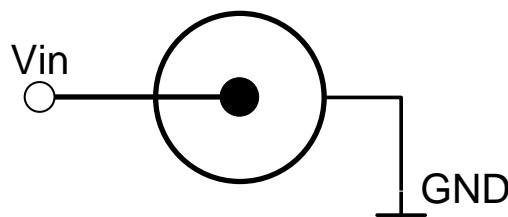

Figure 4-1: Power connector

To connect to X11 use a “DCPP1 e.g. from Cliff Electronic Components” ($\varnothing 2.1\text{mm} * \varnothing 5.5\text{mm} * 9.5\text{mm}$) plug to the power supply. Outer contact is GND, inner contact is Vin.

4.9 X8 – Expansion Connector 1

Almost all pins of the Core Modules' CM1 connector are connected to the expansion connector X8. Variations are marked 'RED'.

X8 Pin No	CM1 Pin No	Detailed Description
1	1	
2	2	
3	3	
4	4	
5	5	
6	6	
7	7	
8	8	
9	9	3.3V ¹⁾
10	10	3.3V ¹⁾
11	11	
12	12	
13	13	
14	14	
15	15	
16	16	
17	17	
18	18	
19	19	
20	20	
21	21	
22	22	
23	23	
24	24	
25	25	
26	26	
27	27	GND
28	-	nc
29	-	5.0V ²⁾
30	-	5.0V ²⁾
31	-	Vin of X11 ³⁾
32	-	Vin of X11 ³⁾
33	-	nc
34	34	
35	35	
36	36	
37	37	
38	38	
39	39	
40	40	
41	41	
42	42	
43	43	
44	44	
45	45	
46	46	

47	47	
48	48	
49	49	
50	50	
51	51	GND
52	52	GND
53	53	
54	54	
55	55	
56	56	
57	57	
58	58	
59	59	
60	60	

Table 4-8: Connector X8 pin assignment

1) Maximum current carrying capacity: **1A**.

2) Pin 29 and 30 of the X8 connector are +5V stabilized from the DC/DC that can be used for custom add-on boards or the extender boards. Maximum current carrying capacity: **900mA**. **Attention:** If Core Modules with USB in host mode are used, the current must be shared with the connected USB device.

3) Pin 31 and 32 of the X7 are Vin of the external power supply minus the input protection diode voltage. These pins can be used for custom add-on board power supplies. Maximum current carrying capacity: **1A**.

4.10 X7 – Expansion Connector 2

Almost all pins of the Core Modules' CM2 connector are connected to the expansion connector X7. Variations are marked 'RED'.

X7 Pin No	CM2 Pin No	Detailed Description
1	61	
2	62	
3	63	
4	64	
5	65	
6	66	
7	67	
8	68	
9	69	
10	70	
11	71	
12	72	
13	73	
14	74	
15	75	
16	76	
17	(77)	Only available if JP4 is mounted *)
18	78	
19	79	GND
20	80	
21	81	
22	82	
23	83	
24	84	
25	85	
26	86	
27	87	
28	88	
29	89	
30	90	
31	91	
32	92	
33	33	
34	94	
35	95	
36	96	
37	97	
38	98	
39	99	Reset
40	100	
41	101	
42	102	
43	103	
44	(104)	Only available if JP5 is mounted *)
45	105	
46	106	

47	107
48	108
49	109
50	110
51	111
52	112
53	113
54	114
55	115
56	116
57	117
58	118
59	119
60	120

Table 4-9: Connector X7 pin assignment

***) Note:** Pin 17 and pin 44 of the X7 connector are not connected, unless the solder jumper JP4 and JP5 are mounted on the bottom of the DEV-BF5xx-Lite board. The signals of pin 77 and pin 104 of the inserted Core Module are routed directly to the USB connector X9 on the DEV-BF5xx-Lite board. Figure 4-1 shows the position of JP4 and JP5. JP4 connects pin 17 and JP5 connects pin 44 see Figure 4-1.

Important: To use the DEV-BF5xxDA-lite in conjunction with the EXT-BF5xx-USB/ETH you have to short JP4 and JP5.

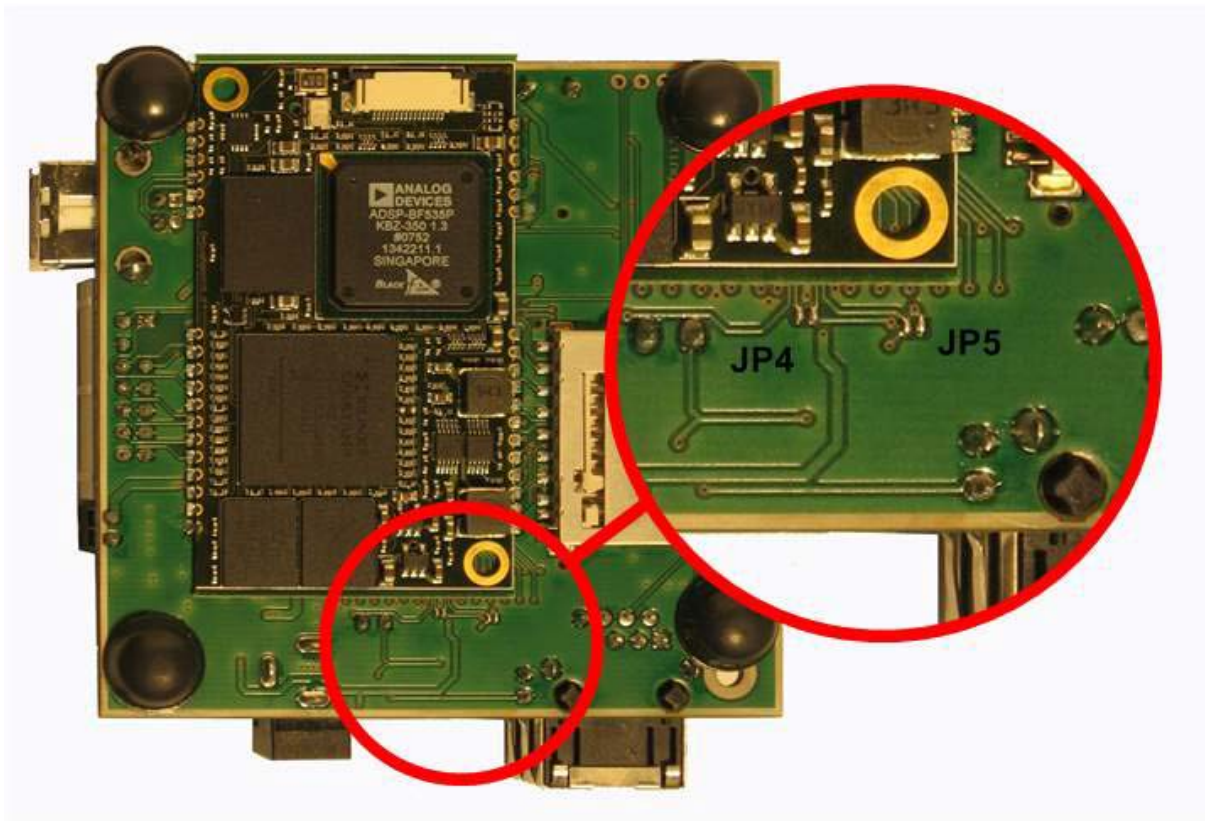

Figure 4-1: Position of JP4 and JP5

5 Switches, Jumper and LED Description

5.1 S1 Ethernet Switch for the CM-BF527 and the CM-BF537E

This 8 pin DIP switch enables the Ethernet connector. It is necessary to switch them on for the Core Modules CM-BF527 and CM-BF537E and off for all others.



Switch Settings	Description
 On Off 1 2 3 4 5 6 7 8	CM-BF527, CM-BF537E
 On Off 1 2 3 4 5 6 7 8	CM-BF533, CM-BF537U, TCM-BF537, CM-BF561, TCM-BF518

Table 5-1: Ethernet Switch

5.2 S2 Core Module Configuration

5.2.1 SD-Card CS and USB VBUS

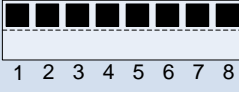



Switch Settings S2 (only 5-8 shown)	Core Module inserted
CM-BF527	 On Off 1 2 3 4 5 6 7 8
CM-BF533 and CM-BF561	 On Off 1 2 3 4 5 6 7 8
CM-BF537U	 On Off 1 2 3 4 5 6 7 8
CM-BF537E and TCM-BF537	 On Off 1 2 3 4 5 6 7 8
TCM-BF518	 On Off 1 2 3 4 5 6 7 8

Table 5-2: Core Module Configuration (1-3 are for Boot Mode only)

For switch settings 1-3 please refer to chapter 6 "Boot Mode Description".

5.2.2 CAN

Switch Settings S2 (only 7-8 shown)	Core Module inserted
CAN enable (ADSP-BF537 only)	 On Off 1 2 3 4 5 6 7 8
CAN disable	 On Off 1 2 3 4 5 6 7 8

Table 5-3: CAN disable

5.3 S4 – UART Switch

Move S4 to position 0 to route the Core Modules RX and TX signals to USB

Move S4 to position 1 to route the Core Modules RX and TX signals to X5

5.4 JP1 - Power Supply Jumper

This jumper can be removed in order to insert an AMPERE METER for current measurement of the entire Core Module.

5.5 JP2 – RTC Power Jumper

This jumper is used to connect the VddRTC pin of the Core Module to 3.3V. You can also use this jumper to connect a battery (Vcc) to the internal RTC of the Blackfin. For connecting GND use pin 3 of the UART expansion pads.

5.6 JP3

For the CM-BF527 JP3 is used to connect the USB-ID pin to the Core Module. For all other Core Modules, leave it open!

5.7 JP6 USB-ID

For the CM-BF527 JP6 is used to force the USB-OTG master mode. For all other Core modules leave it open!

5.8 Buttons S3, S6

The Button S3 is the main Reset Button of the Core Module.

The Button S6 is a general-purpose input button on pin 18 of the Core Module.

Core Module	Button S6
CM-BF527	PF14
CM-BF533	PF5
CM-BF537E	PG14
CM-BF537U	PG14
CM-BF561	PF46
TCM-BF537	PG14
TCM-BF518	PF14

Table 5-4: Pin assignment of button S6

5.9 General Purpose LEDs

The LED V14 indicates that the board is powered.

The LED's V9 and V10 are connected to general-purpose IO pins 45 and 16 respectively.

Core Module	LED V9	LED V10
CM-BF527	PF11	PF10
CM-BF533	PF8	PF9
CM-BF537E	PG11	PG10
CM-BF537U	PG11	PG10
CM-BF561	PF43	PF42
TCM-BF537	PG11	PG10
TCM-BF518	PF11	PF10

Table 5-5: Core Module LEDs

5.10 Ethernet LEDs

Designator	Color	Function
V1	Yellow	Full Duplex
V2	Green	Activity

V3	Green	100MB Speed LED
----	-------	-----------------

Table 5-6: Ethernet LEDs

5.11 LEDs of the Debug Agent

Designator	Color	Function
V5	Green	Flag0
V6	Green	Flag1
V7	Green	Monitor
V8	Green	Pr. done

Table 5-7: LEDs for the Debug Agent

6 Boot Mode Description

Only switch 1-3 of S2 are described in this section. Please refer to section 5.2 to see the settings for switch 4-8.

Boot-settings for CM-BF527 (S2) only Switches 1 – 3 are shown

Switch 4 is not used for boot mode settings, so the Boot Modes 8-15 of the CM-BF527 cannot be used. For details of boot mode 8-15 see the datasheet of the processor.









Switch Settings BMODE0,BMODE1,BMODE2		Boot Mode	Description
	On Off	0	Idle – No boot
	On Off	1	Boot from 8Bit or 16Bit EEPROM/Flash (Standard boot mode for BLACKSheep, uBoot and uClinux)
	On Off	2	Boot from 16-bit asynchronous FIFO.
	On Off	3	Boot from serial SPI Memory
	On Off	4	Boot from SPI Host (slave mode)
	On Off	5	Boot from serial TWI memory
	On Off	6	Boot from TWI host (slave mode)
	On Off	7	Boot from UART0 host (slave mode)

Table 6-1: Boot Mode CM-BF527 Type

Boot-settings for CM-BF533 (S2) only Switches 1 – 3 are shown

Switch Settings	Boot Mode	Description
-----------------	-----------	-------------

BMODE0,BMODE1			
	On Off	0	Execute from 16Bit ext. mem. Bypass ROM (Standard boot mode for uBoot, uClinux)
	On Off	1	Boot from 8Bit or 16Bit EEPROM/Flash (Standard boot mode for BLACKSheep)
	On Off	2	Boot from SPI 8Bit
	On Off	3	Boot from SPI 16Bit

Table 6-2: Boot Mode CM-BF533

Boot-settings for CM-BF537E, CM-BF537U and TCM-BF537 (S2) only Switches 1 – 3 are shown

Switch Settings BMODE0,BMODE1,BMODE2		Boot Mode	Description
	On Off	0	Execute from 16Bit ext. mem. Bypass ROM (Standard boot mode for uBoot, uClinux)
	On Off	1	Boot from 8Bit or 16Bit EEPROM/Flash (Standard boot mode for BLACKSheep)
	On Off	2	Reserved
	On Off	3	Boot from serial SPI Memory
	On Off	4	Boot from SPI Host (slave mode)
	On Off	5	Boot from serial TWI memory
	On Off	6	Boot from TWI host (slave mode)
	On Off	7	Boot from UART0 host (slave mode)

Table 6-3: Boot Mode CM-BF537 Types

Boot-settings for CM-BF561 (S2) only Switches 1 – 3 are shown

Attention: Switch 4-8 are not used for boot mode settings. Please refer to section 7 to see the settings for switch 4-8.

If you are using a CM-BF561 set switches 1-3 of S2 to OFF!

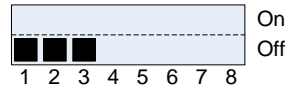

Due to the limited number of pins on the two connectors, the CM-BF561 can only set its boot mode on the core module itself by changing the resistor settings. See the CM-BF561 manual for further details.

Boot-settings for TCM-BF518 (S2) only Switches 1 – 3 are shown







Switch Settings BMODE0,BMODE1,BMODE2	Boot Mode	Description
	0	Idle – No boot
	1	Boot from 8Bit or 16Bit EEPROM/Flash (Standard boot mode for BLACKSheep, uBoot and uClinux)
	2	Boot from internal SPI memory
	3	Boot from external SPI memory (EEPROM or flash)
	4	Boot from SPI Host
	5	Boot from OTP memory
	6	Boot from SDRAM
	7	Boot from UART0

Table 6-4: Boot Mode TCM-BF518 Type

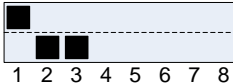
7 Using a Core Module with on board USB

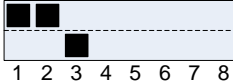
If you use a Core Module with USB feature, for example the CM-BF527 set switch 4 of S2 to “on”. This connects the 5.0V pin of the USB connector X9 to pin 53 of the Core Module.

If you do not use a Core Module with on board USB feature the switch 4 of S2 should always remain “off”.

8 Installation

8.1 Initial Board Setup

The installation guide is written for Windows (Windows 2000 and WinXP). However for connecting the USB device the drivers for MAC and LINUX are available on the CD.

In order to set up and test the board the follow the next steps:

1. Make sure the Jumper **JP1** and **JP2** are set and the switch **S4** is in position **0** as shown in Figure 8-1 .

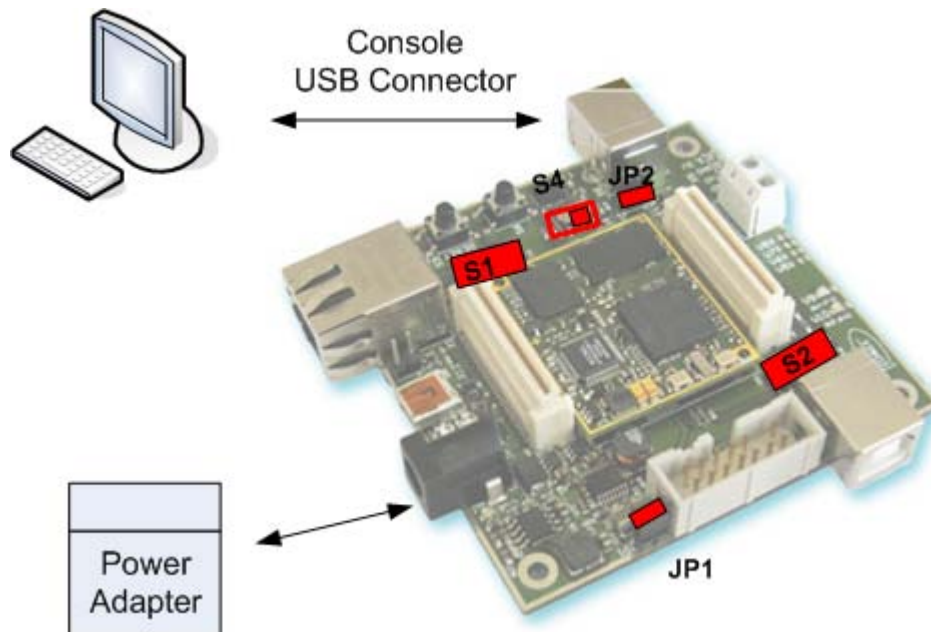
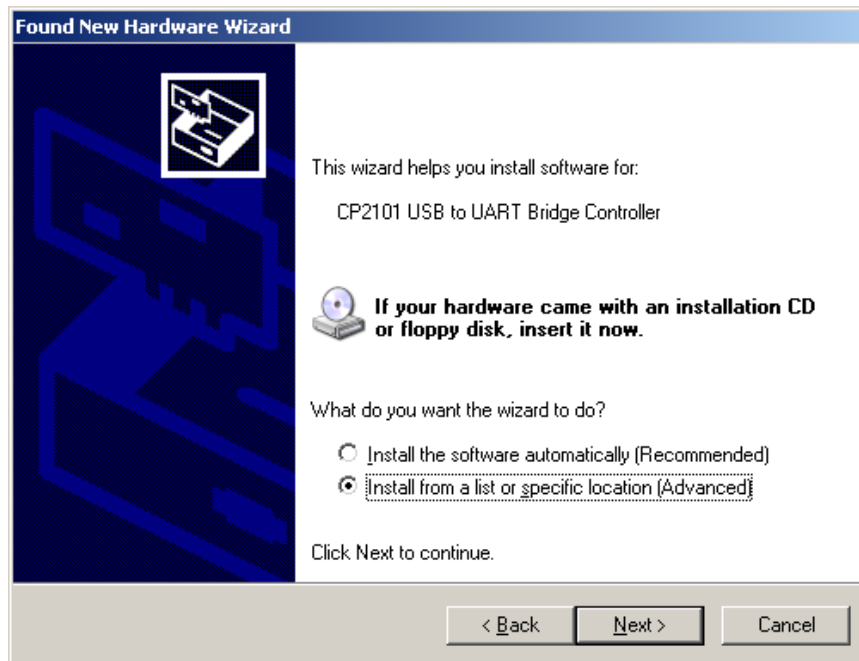

Figure 8-1: Setup of the DEV-BF5xxDA-Lite Board

2. Set switch **S2** according **chapter 5.2 and 6**. Set switch **S1** according chapter **5.1**.
3. Connect the power supply to the power connector of the DEV-BF5xxDA-Lite board.
4. Connect the DEV-BF5xxDA-Lite Board via USB to the PC. The pre-flashed BLACKSheep starts and the LED mounted on the EVAL board starts blinking. On the PC usually the 'Found New Hardware Wizard' opens.



If the wizard asks connect to the windows update site, select "No, not this time"



Choose: "Install from a list or specific location". The driver is located on your support CD.

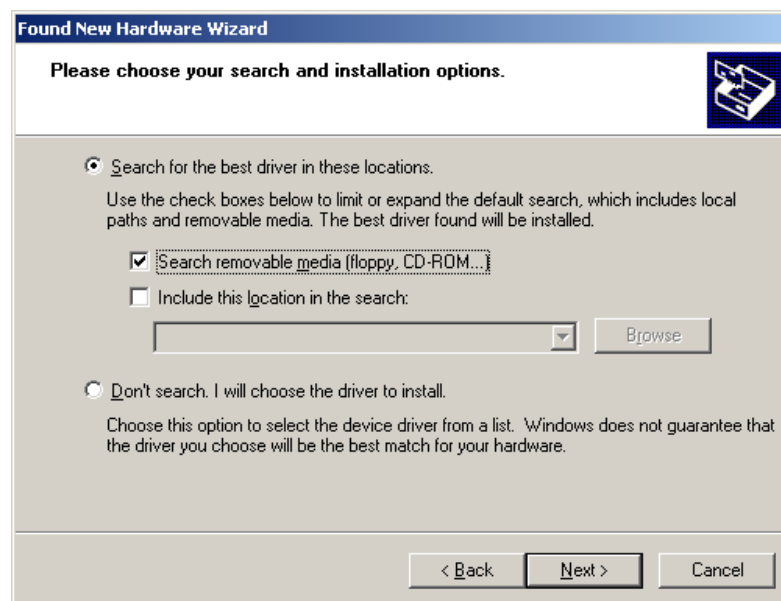

This procedure has to be done twice, because at first the USB driver will be installed. Then the Hardware Wizard opens again, because the UART bridge driver has to be installed in addition using the same driver file. Simply repeat this step.

5. Open the Windows device manager (Control Panel → System → Hardware) to see which COM port number has been assigned to the CP2101 UART-to-USB Chip. This number differs from computer to computer based on the already installed COM ports. (e.g. COM4)

- Open a Terminal program like the HyperTerminal included in Windows operating systems and open the respective COM port with **115200 Baud, 8 Data-bits, No Parity and 1 Stop bit, disable the Hardware flow control**.
- Reset the DEV-BF5xxDA-Lite Board (Press the main reset button). After this you will see the BLACKSheep boot-screen showing up. If you disconnect the device, you have to reconnect.

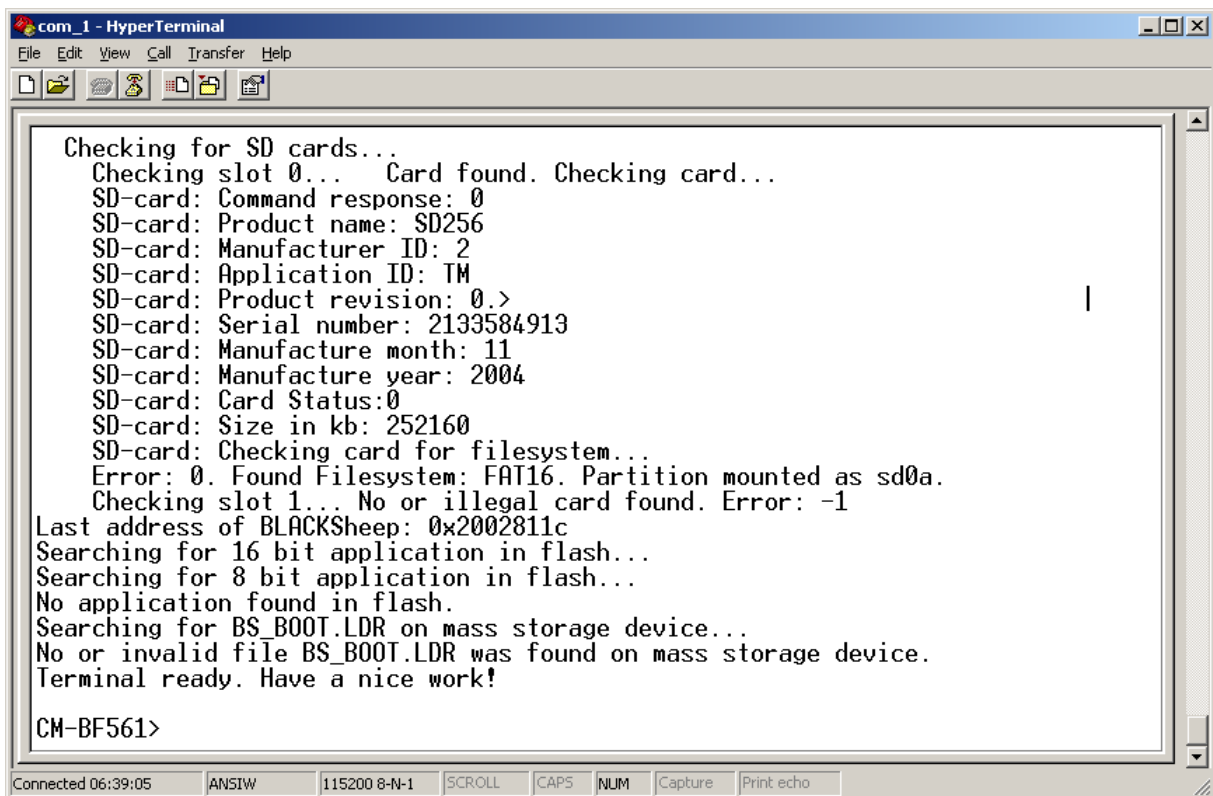

```

com_1 - HyperTerminal
File Edit View Call Transfer Help
Checking for SD cards...
Checking slot 0... Card found. Checking card...
SD-card: Command response: 0
SD-card: Product name: SD256
SD-card: Manufacturer ID: 2
SD-card: Application ID: TM
SD-card: Product revision: 0.>
SD-card: Serial number: 2139584913
SD-card: Manufacture month: 11
SD-card: Manufacture year: 2004
SD-card: Card Status:0
SD-card: Size in kb: 252160
SD-card: Checking card for filesystem...
Error: 0. Found Filesystem: FAT16. Partition mounted as sd0a.
Checking slot 1... No or illegal card found. Error: -1
Last address of BLACKSheep: 0x2002811c
Searching for 16 bit application in flash...
Searching for 8 bit application in flash...
No application found in flash.
Searching for BS_BOOT.LDR on mass storage device...
No or invalid file BS_BOOT.LDR was found on mass storage device.
Terminal ready. Have a nice work!
CM-BF561>
Connected 06:39:05 ANSIV 115200 8-N-1 SCROLL CAPS NUM Capture Print echo

```

This shows a sample boot screen. Depending on the current software version, you might get different boot messages.

- You can find a simple hello world program on your support CD or at the download section of the product homepage. To start the sample program, type `"xmr UART"` on your terminal program, then (Transfer → Send file) select the appropriate file `"UART.ldr"` depending on your Core Module, choose protocol `"Xmodem"` and send. After the download has finished type `"exec UART"` to execute the sample program.
- Press reset to return to the BLACKSheep command line.

8.2 Debug Agent Setup (Only for DEV-BF5xxDA-Lite)

If you have purchased a DEV-BF5xxDA-Lite board with the Debug Agent mounted on the bottom side of the board you can use it to download and debug your software with the VDSP++ development environment from Analog Devices. An evaluation version is included in the support CD or you can download it from our website or the website from Analog Devices. Currently the Debug Agent works only with version 4.5 of the VDSP++ IDE.

Note: The Core Module will get warm while in use.

Please follow the instructions for installing and configuring VDSP++ to work with the Debug Agent.

- Install VDSP++4.5

2. If available install the latest update for VDSP++4.5. You can download updates from the Analog Devices website.
3. Configure VDSP++4.5 to support the DEV-BF5xxDA-Lite by starting the Installer from your support CD. Once started you should see the following dialog.

Note: To run the installer the .net framework is required!



4. Select the Core Module that you have inserted in the socket of your DEV-BF5xxDA-Lite.
5. Press the "Install" button.
6. You should get the following message:

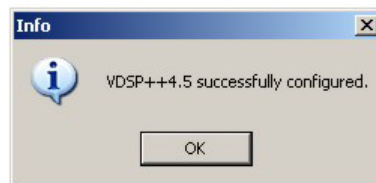

7. Be sure that the board is powered on!
8. Connect X4 (USB JTAG) with a USB cable to a free USB port on your PC.
9. The following dialog or a similar one should appear:



10. Choose "Install the software automatically", press "Next" and follow the on-screen instructions.

After the install process you have to create a Platform using the Platform Wizard of the VDSP++. Follow the instructions to create a valid Platform for the Bluetechnix USB Debug Agent.

1. Open the VisualDSP++ Configurator from the start menu entry of VisualDSP++ 4.5.

2. Select "New..."
3. In the "Type" box select the Bluetechnix entry corresponding to the Core Module on your DEV-BF5xxDA-Lite board.
4. Enter a Name for the Platform for example "Bluetechnix CM-BF537".

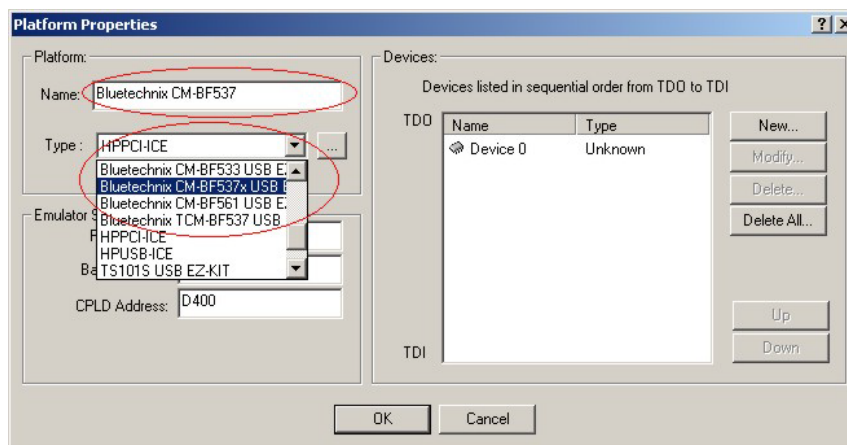

5. Select "Ok". The created platform should appear in the "Platforms" section of the "configurator" window.

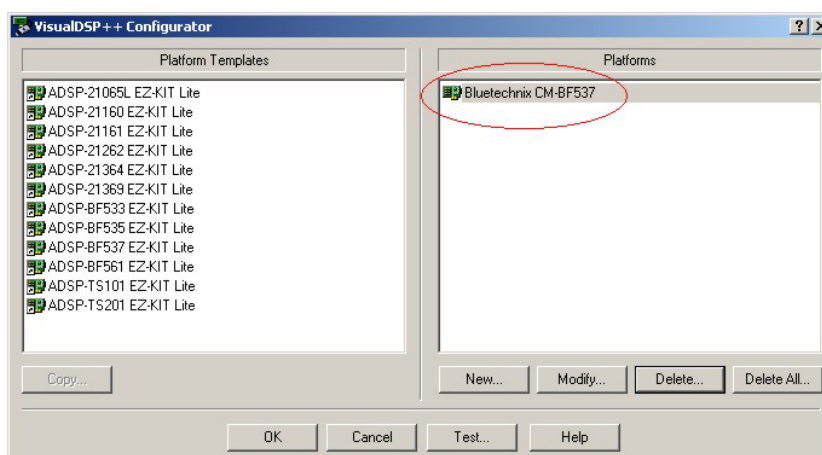

6. Press "Ok" to close the VisualDSP++ Configurator.

The last step is the creation of a VDSP++ debug session. Follow the instructions below:

1. Open the "New Session Wizard" from the pulldown menu of the VDSP++ (Session→New Session) or press the "New Session" button on the "Session List" window that appears on startup of VDSP++.
2. Select the processor corresponding to your Core Module and press "Next".

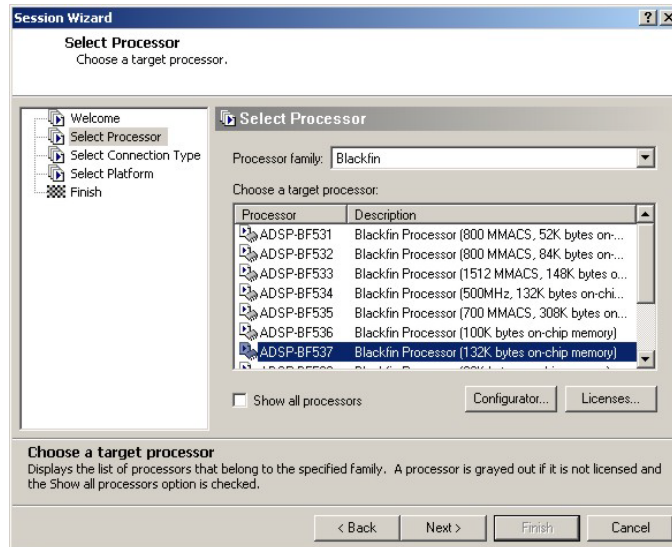

3. Select "EZ-KIT Lite" and press "Next".

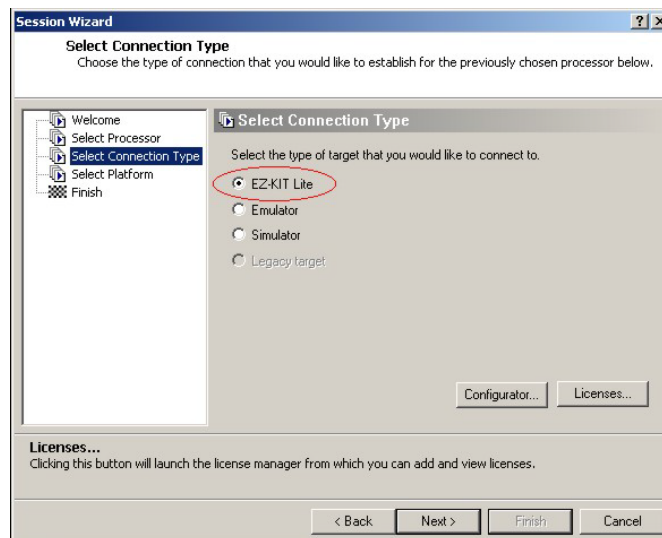

4. Select the platform that you have created with the VisualDSP++ Configurator and press "Finish".

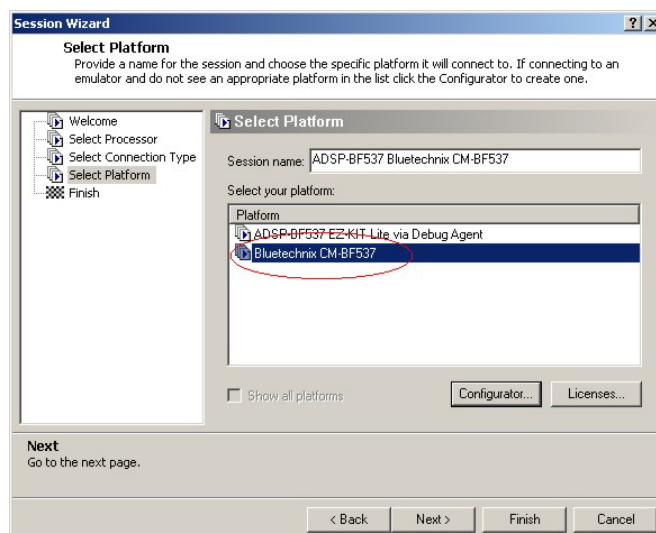

Now the session is ready and VDSP++ should start with these settings. The Core Module on the DEV-BF5xxDA-Lite is now ready for debugging.

For further information about the session wizard and the VDSP++ tools please refer to the VDSP++ manuals downloadable from the Analog Devices website.

If you change your Core Module on the DEV-BF5xxDA-Lite you have to reconfigure VDSP++ starting with the install tool as described above.

9 Using the VDSP Flash Programming Tool

9.1 Developing an Application

If you are developing your own projects with the VDSP++ development tools, including the JTAG provided by Analog Devices you can use the flash programming tool included in the VDSP++ environment in order to flash your program on the Core Module. You have to load the flash driver located on your EVAL board support CD corresponding to the inserted Core Module.

9.2 Overwriting BLACKSheep Code

If you overwrite intentionally or unintentionally the section in the flash containing the BLACKSheep code, **you will need a JTAG device** and the VDSP++ flash tool to reprogram the flash. Flashing the appropriate BLACKSheep loader file (*.ldr) located on the CD, reinstalls the BLACKSheep code.

The examples, drivers and the BLACKSheep software are under permanent development. Please refer to the download section of www.bluetechnix.com to get the latest versions or updates.

10 Extender Board Compatibility List

This chapter points out the compatibility of the EVAL-BF5xx and DEV-BF5xxDA-Lite with Core Module and Extension Boards. Please refer to the Extender board and Core Module Hardware Manuals for further information.

Legend:

OK	Full functional
(OK)	Functional but not all features are available
NO	Not functional
NG	Functionality not guaranteed
NT	Not tested yet
Limited	Limited

In the following tables show possible Board combinations:

10.1 Without an Extender Board

Core Module	CM-BF527	CM-BF533	CM-BF537E	CM-BF537U	TCM-BF537	CM-BF561	TCM-BF518
No Extender	OK	OK	OK	OK	OK	OK	OK

Table 10-1: Used without an Extender Board

10.2 Experimental Extender Board

Core Module	CM-BF527	CM-BF533	CM-BF537E	CM-BF537U	TCM-BF537	CM-BF561	TCM-BF518
EXT-BF5xx-EXP	OK	OK	OK	OK	OK	OK	OK

Table 10-2: Used with the Experimental Extender Board

All boards can be used in combination with the Experimental Extender Board

10.3 Video Extender Board

Core Module	CM-BF527	CM-BF533	CM-BF537E	CM-BF537U	TCM-BF537	CM-BF561	TCM-BF518
EXT-BF5xx-Video	NT	OK	OK	OK	OK	OK	NT

Table 10-3: Used with the Video Extender Board

10.4 Audio Extender Board

Core Module	CM-BF527	CM-BF533	CM-BF537E	CM-BF537U	TCM-BF537	CM-BF561	TCM-BF518
EXT-BF5xx-Audio	NT	NT	NT	NT	NT	NT	NT

Table 10-4: Used with the Audio Extender Board

10.5 Camera Extender Board

Core Module	CM-BF527	CM-BF533	CM-BF537E	CM-BF537U	TCM-BF537	CM-BF561	TCM-BF518
EXT-BF5xx-Camera	NT	(OK)*	(OK)*	(OK)*	(OK)*	(OK)**	NT

Table 10-5: Used with the Camera Extender Board

*) Mono Camera or Display

***) Stereo Camera or Mono Camera and Display

10.6 Analog-Digital / Digital-Analog Converter Extender Board

Core Module	CM-BF527	CM-BF533	CM-BF537E	CM-BF537U	TCM-BF537	CM-BF561	TCM-BF518
EXT-BF5xx-AD/DA	NT	OK	OK	OK	OK	OK	NT

Table 10-6: Used with the Analog-Digital / Digital-Analog Converter Extender Board

10.7 USB-ETH Extender Board

Core Module	CM-BF527	CM-BF533	CM-BF537E	CM-BF537U	TCM-BF537	CM-BF561	TCM-BF518
EXT-BF5xx-USB-ETH	NT	Limited *)	Limited *)	Limited *)	OK	Limited *)	NO
EXT-BF518-ETH	NO	NO	NO	NO	NO	NO	OK

Table 10-7: Used with the USB-ETH Extender Board

*) Limited: only the USB 2.0 Device functionality is available

10.8 Video and Audio Extender Board

Core Module	CM-BF527	CM-BF533	CM-BF537E	CM-BF537U	TCM-BF537	CM-BF561	TCM-BF518
EXT-BF5xx-Video	NT	NT	NT	NT	NT	NT	NT
EXT-BF5xx-Audio	NT	NT	NT	NT	NT	NT	NT

Table 10-8: Used with the Video and the Audio Extender Board

10.9 Camera and Audio Extender Board

Core Module	CM-BF527	CM-BF533	CM-BF537E	CM-BF537U	TCM-BF537	CM-BF561	TCM-BF518
No EXT-BF5xx-Camera	NT	NT	NT	NT	NT	NT	NT
EXT-BF5xx-Audio	NT	NT	NT	NT	NT	NT	NT

Table 10-9: Used with the Camera and the Audio Extender Board

11 Anomalies

For up-to-date information about this product, please consult the product's homepage:

<http://www.bluetechnix.com/goto/dev-bf5xxda-lite>

12 Document Revision History

Version	Date	Document Revision
15	2012-01-19	Support for TCM-BF518 added
14	2009-05-26	New Layout
13	2009-05-26	Table 5.3 added
12	2009-01-26	Picture of boot mode changed Getting started adapted. Block diagrams updated
11	2009-01-12	Chapter 2: Description changed
10	2008-12-15	Table 4.7 footnotes changed;
9	2008-10-22	S2 for CM-BF527; Quickstart guide; Figure 4.1;
8	2008-08-18	English checked for grammar, spelling and clarity.
7	2008-05-29	VDSP++ Version
6	2008-05-08	Document Release Pin Assignment Changed
3 to 5	2008-04	Several Changes
2	2008-04-01	Extender Board Compatibility List
1	2007-03-01	Initial release of the document

Table 12-1: Revision History

A List of Figures and Tables

Figures:

Figure 1-1: Overview of the Dev-BF5xx-Lite Board.....	7
Figure 2-1: Block Diagram	9
Figure 3-1: Connector PCB Placement.....	10
Figure 3-2: Mechanical Outline – Expansion Connector Placement (top view)	11
Figure 3-3: Recommended Footprint for Extension Boards (top view)	12
Figure 4-1: Position of JP4 and JP5.....	18
Figure 8-1: Setup of the DEV-BF5xxDA-Lite Board.....	24

Tables:

Table 4-1: Ethernet Connector.....	13
Table 4-2: SD-Card Connector.....	13
Table 4-3: UART Connector.....	13
Table 4-4: DEV-board connector types.....	14
Table 4-5: DEV-board matching connector types.....	14
Table 4-6: CAN Connector.....	14
Table 4-7: Power Supply.....	14
Table 4-8: Connector X8 pin assignment.....	16
Table 4-9: Connector X7 pin assignment.....	18
Table 5-1: Ethernet Switch.....	19
Table 5-2: Core Module Configuration (1-3 are for Boot Mode only).....	19
Table 5-3: CAN disable.....	19
Table 5-4: Pin assignment of button S6.....	20
Table 5-5: Core Module LEDs.....	20
Table 5-6: Ethernet LEDs.....	21
Table 5-7: LEDs for the Debug Agent.....	21
Table 6-1: Boot Mode CM-BF527 Type.....	21
Table 6-2: Boot Mode CM-BF533.....	22
Table 6-3: Boot Mode CM-BF537 Types.....	22
Table 6-4: Boot Mode TCM-BF518 Type.....	23
Table 10-1: Used without an Extender Board.....	31
Table 10-2: Used with the Experimental Extender Board.....	31
Table 10-3: Used with the Video Extender Board.....	31
Table 10-4: Used with the Audio Extender Board.....	31
Table 10-5: Used with the Camera Extender Board.....	31
Table 10-6: Used with the Analog-Digital / Digital-Analog Converter Extender Board.....	32
Table 10-7: Used with the USB-ETH Extender Board.....	32
Table 10-8: Used with the Video and the Audio Extender Board.....	32
Table 10-9: Used with the Camera and the Audio Extender Board.....	32
Table 12-1: Revision History.....	33