

ASMT-Jx3x

3W Mini Power LED Light Source



Data Sheet



Description

The 3W Mini Power LED Light Source is a high performance energy efficient device which can handle high thermal and high driving current. Option with electrically isolated metal slug is also available.

The White Mini Power LED is available in the range of color temperature from 2700K to 10000K.

The low profile package design and ultra small footprint is suitable for a wide variety of applications especially where space and height is a constraint.

The package is compatible with reflow soldering process. To facilitate easy pick & place assembly, the LEDs are packed in EIA-compliant tape and reel.

Features

- Available in Red, Red Orange, Amber, Green, Blue, Royal Blue, Cool White, Neutral White and Warm White
- Small footprint and low profile
- Symmetrical outline
- Energy efficient
- Direct heat transfer from metal slug to mother board
- Compatible with reflow soldering process
- High current operation
- Long operation life
- Wide viewing angle
- Silicone encapsulation
- Non-ESD sensitive (threshold > 16kV)
- MSL 1 products

Applications

- Sign backlight
- Safety, exit and emergency sign lightings
- Specialty lighting such as task lighting and reading lights
- Retail display
- Commercial lighting
- Accent or marker lightings, strip or step lightings
- Portable lightings, bicycle head lamp, torch lights.
- Decorative lighting
- Architectural lighting
- Pathway lighting
- Street lighting
- Pedestrian street lighting
- Tunnel lighting

CAUTION: Customer is advised to keep the LEDs in the MBB when not in use as prolonged exposure to environment might cause the silver plated leads to tarnish, which might cause difficulties in soldering.

Package Dimensions

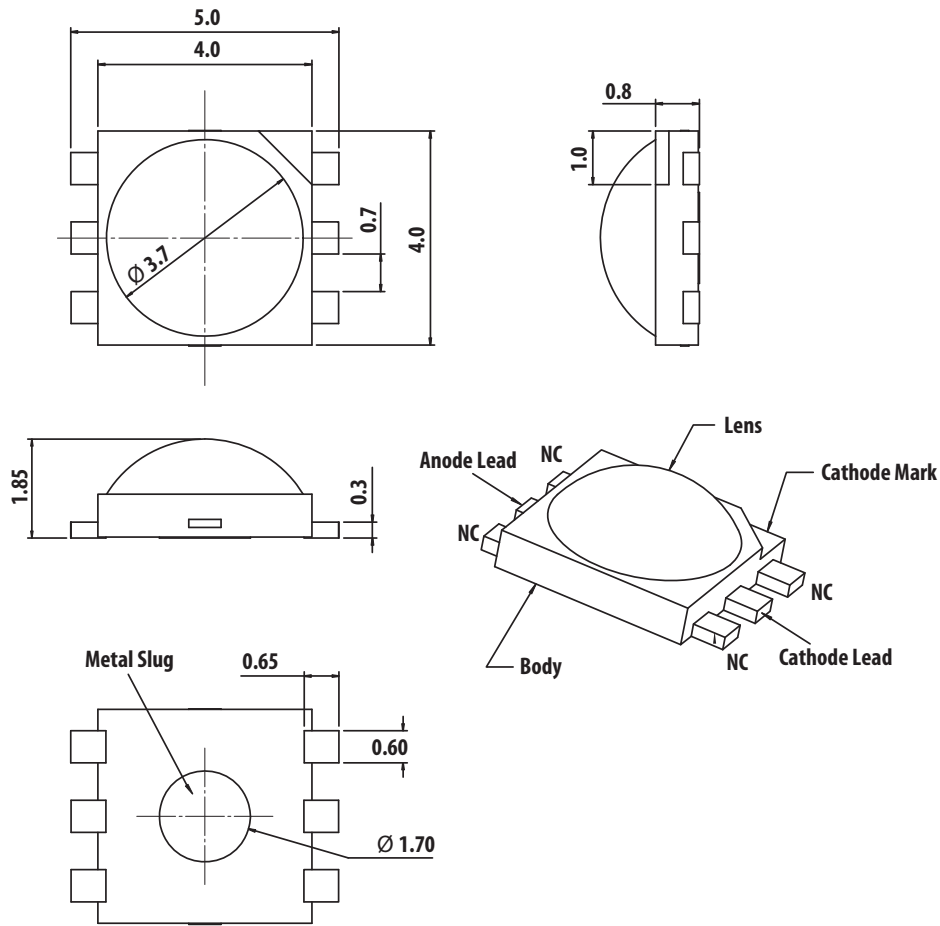
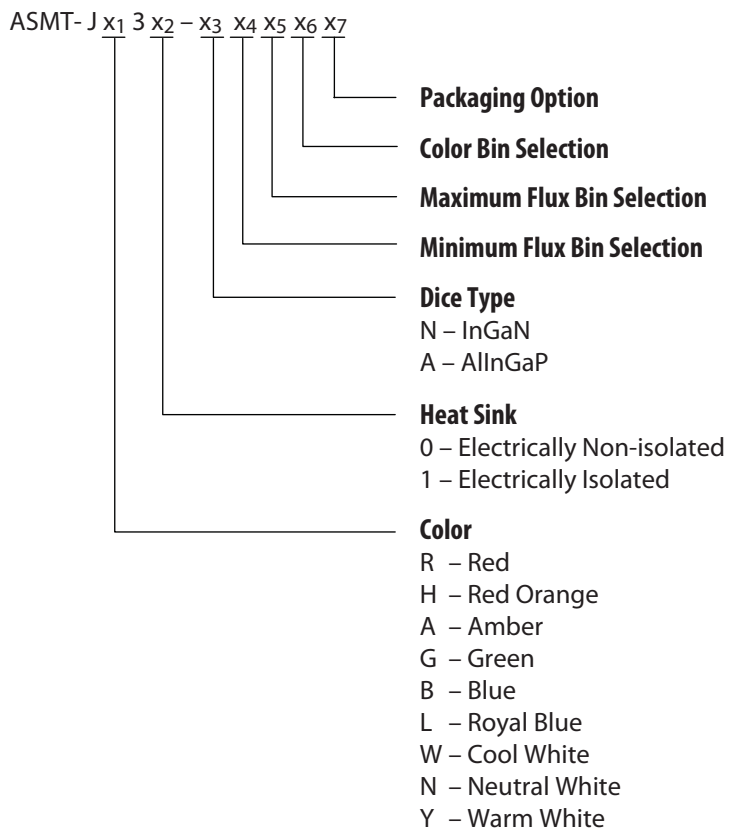

Figure 1. ASMT-Jx3x package outline drawing

Notes:

1. All dimensions in millimeters.
2. Metal slug is connected to anode for electrically non-isolated option.
3. Tolerance is ± 0.1 mm unless otherwise specified.
4. Terminal finish: Ag plating.
5. Corresponding NC (No Connection) leads adjacent to anode and cathode leads can be electrically short.

Part Numbering System



Note:

1. Please refer to Page 10 for selection details.

Device Selection Guide (T_J = 25°C)

Part Number	Color	Luminous Flux (lm) / Radiometric Power (mW), Φ_V [1,2]			Test Current (mA)	Dice Technology	Electrically Isolated Metal Slug
		Min.	Typ.	Max.			
ASMT-JR30-ARS01	Red	39.8	45.0	67.2	350	AllnGaP	No
ASMT-JH30-ARS01	Red Orange	39.8	45.0	67.2	350	AllnGaP	No
ASMT-JA30-ARS01	Amber	39.8	45.0	67.2	350	AllnGaP	No
ASMT-JG31-NST01	Green	51.7	70.0	87.4	350	InGaN	Yes
ASMT-JB31-NMP01	Blue	13.9	20.0	30.6	350	InGaN	Yes
ASMT-JL31-NPQ01	Royal Blue	355 mW	435 mW	515 mW	350	InGaN	Yes
ASMT-JW31-NTV01	Cool White	67.2	85.0	113.6	350	InGaN	Yes
ASMT-JW31-NUV01		87.4	95.0	113.6	350	InGaN	Yes
ASMT-JN31-NTV01	Neutral White	67.2	85.0	113.6	350	InGaN	Yes
ASMT-JN31-NUV01		87.4	95.0	113.6	350	InGaN	Yes
ASMT-JY31-NSU01	Warm White	51.7	70.0	99.6	350	InGaN	Yes

Notes:

1. Φ_V is the total luminous flux / radiometric power output as measured with an integrating sphere at 25ms mono pulse condition.
2. Flux tolerance is $\pm 10\%$

Absolute Maximum Ratings

Parameter	AllnGaP	InGaN	Units
DC Forward Current ^[1]	700	700	mA
Peak Pulsing Current ^[2]	1000	1000	mA
Power Dissipation	2450	3010	mW
LED Junction Temperature	125	135	°C
Operating Metal Slug Temperature Range at 350 mA	-40 to +115	-40 to +120	°C
Operating Metal Slug Temperature Range at 700 mA	-40 to +100	-40 to +105	°C
Storage Temperature Range	-40 to +120	-40 to +135	°C
Soldering Temperature	Refer to Figure. 25		
Reverse Voltage ^[3]	Not recommended		

Note:

1. Derate linearly based on Figure 9 for AllnGaP and Figure 21 for InGaN.
2. Pulse condition duty factor = 10%, Frequency = 1 kHz.
3. Not designed for reverse bias operation.

Optical Characteristics at 350 mA (T_J = 25°C)

Part Number	Color	Peak Wavelength, λ_{PEAK} (nm)	Dominant Wavelength, λ_D ^[1] (nm)	Viewing Angle, $2\theta_{1/2}$ ^[2] (°)	Luminous Efficiency (lm/W)
		Typ.	Typ.	Typ.	Typ.
ASMT-JR30-ARS01	Red	635	625	165	61
ASMT-JH30-ARS01	Red Orange	625	615	165	61
ASMT-JA30-ARS01	Amber	598	590	165	61
ASMT-JG31-NST01	Green	519	525	165	63
ASMT-JB31-NMP01	Blue	460	470	165	18
ASMT-JL31-NPQ01	Royal Blue	450	455	165	Not Applicable

Part Number	Color	Correlated Color Temperature, CCT (Kelvin)		Viewing Angle, $2\theta_{1/2}$ ^[2] (°)	Luminous Efficiency (lm/W)
		Min.	Max.	Typ.	Typ.
ASMT-JW31-NTV01	Cool White	4500	10000	140	76
ASMT-JW31-NUV01		4500	10000	140	85
ASMT-JN31-NTV01	Neutral White	3500	4500	140	76
ASMT-JN31-NUV01		3500	4500	140	85
ASMT-JY31-NSU01	Warm White	2700	3500	140	63

Notes:

1. The dominant wavelength, λ_D , is derived from the CIE Chromaticity Diagram and represents the color of the device.
2. $\theta_{1/2}$ is the off-axis angle where the luminous intensity is 1/2 the peak intensity.

Electrical Characteristic at 350 mA ($T_J = 25^\circ\text{C}$)

Dice Type	Forward Voltage, V_F (Volts)			Thermal Resistance, $R_{\theta_{j-ms}}(^{\circ}\text{C}/\text{W})$ [1]
	Min.	Typ	Max.	Typ.
AllnGaP	1.7	2.1	2.3	9
InGaN	2.8	3.2	3.5	9

Note:

1. $R_{\theta_{j-ms}}$ is Thermal Resistance from LED junction to metal slug.

Optical and Electrical Characteristic at 700 mA ($T_J = 25^\circ\text{C}$)

Part Number	Color	Luminous Flux (lm) / Radiometric Power (mW), ϕ_V	Forward Voltage, V_F (Volts)
		Typ.	Typ.
ASMT-JR30-ARS01	Red	80.0	2.4
ASMT-JA30-ARS01	Amber	80.0	2.4
ASMT-JH30-ARS01	Red Orange	80.0	2.4
ASMT-JG31-NST01	Green	120.0	3.6
ASMT-JB31-NMP01	Blue	34.0	3.6
ASMT-JL31-NPQ01	Royal Blue	740 mW	3.6
ASMT-JW31-NTV01	Cool White	150.0	3.6
ASMT-JW31-NUV01		160.0	3.6
ASMT-JN31-NTV01	Neutral White	150.0	3.6
ASMT-JN31-NUV01		160.0	3.6
ASMT-JY31-NSU01	Warm White	120.0	3.6

AlInGaP

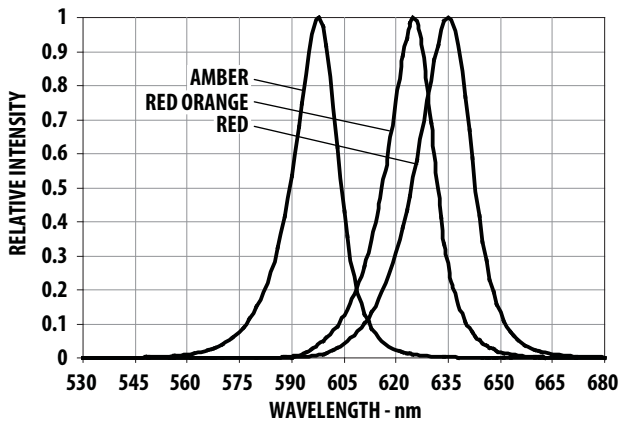

Figure 2. Relative Intensity vs. Wavelength for Red, Red Orange and Amber.

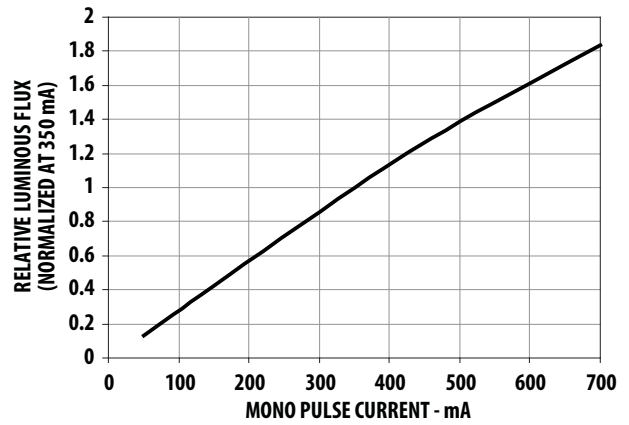

Figure 3. Relative Luminous Flux vs. Mono Pulse Current.

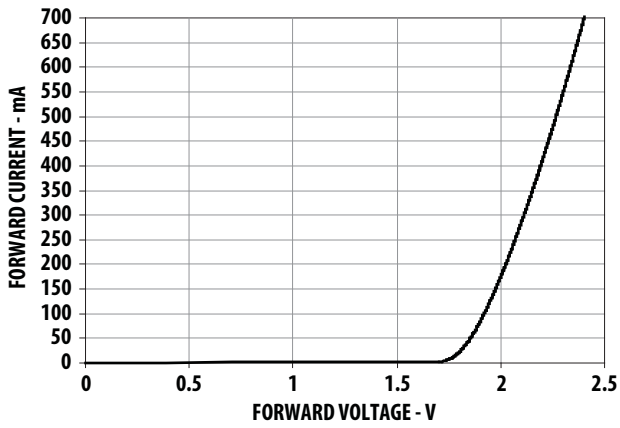

Figure 4. Forward Current vs. Forward Voltage.

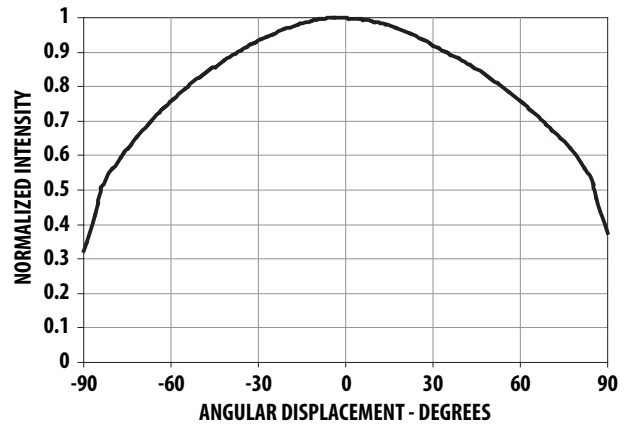

Figure 5. Radiation Pattern Red, Red Orange and Amber.

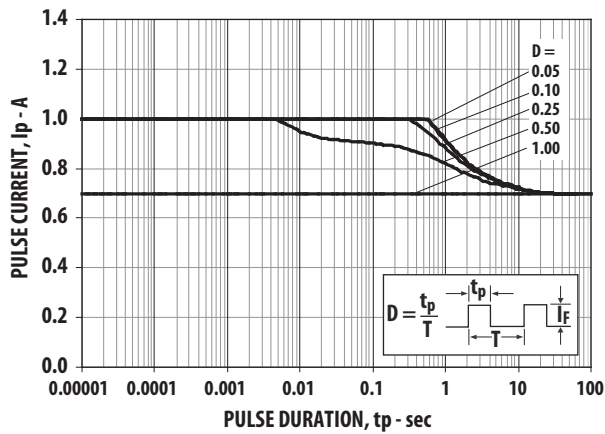

Figure 6. Maximum pulse current vs. ambient temperature. Derated based on $T_A = 25^\circ\text{C}$, $R_{\theta JA} = 30^\circ\text{C/W}$.

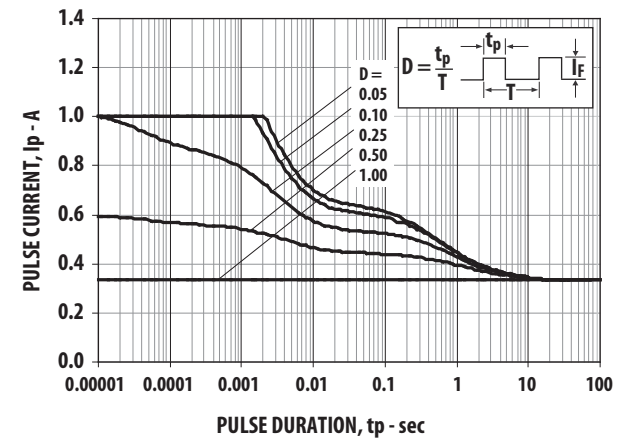

Figure 7. Maximum pulse current vs. ambient temperature. Derated based on $T_A = 85^\circ\text{C}$, $R_{\theta JA} = 30^\circ\text{C/W}$.

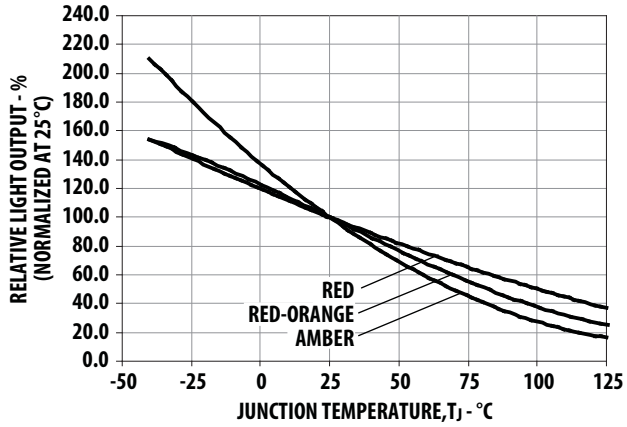

Figure 8. Relative Light Output vs. Junction Temperature.

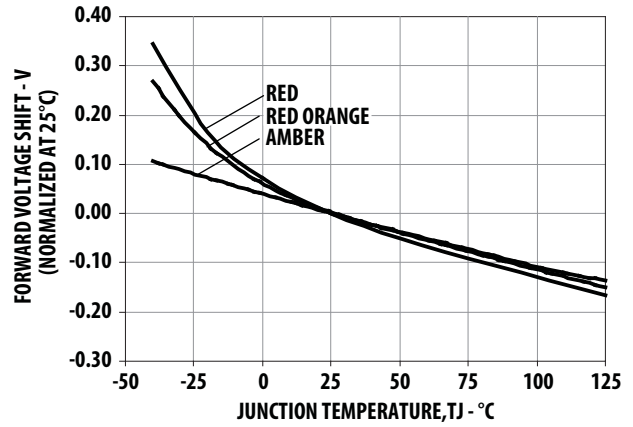

Figure 9. Forward Voltage Shift vs. Junction Temperature.

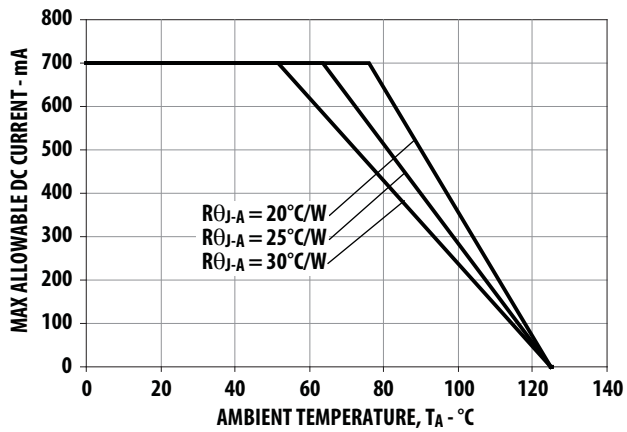

Figure 10. Maximum Forward Current vs. Ambient Temperature. Derated based on $T_{JMAX} = 125^{\circ}C$, $R_{\theta JA} = 20^{\circ}C/W$, $25^{\circ}C/W$ and $30^{\circ}C/W$.

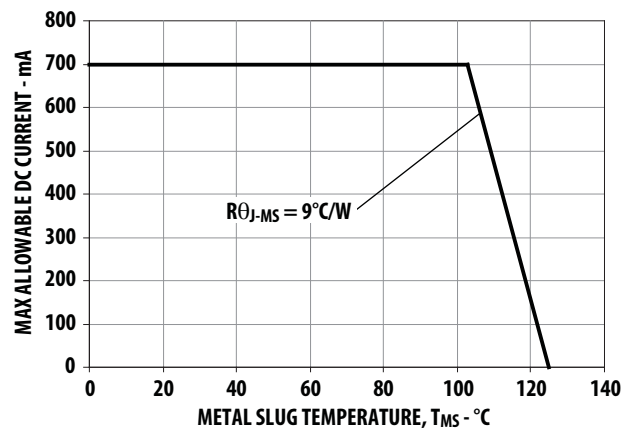

Figure 11. Maximum Forward Current vs. Ambient Temperature. Derated based on $T_{JMAX} = 125^{\circ}C$, $R_{\theta MS} = 9^{\circ}C/W$.

InGaN

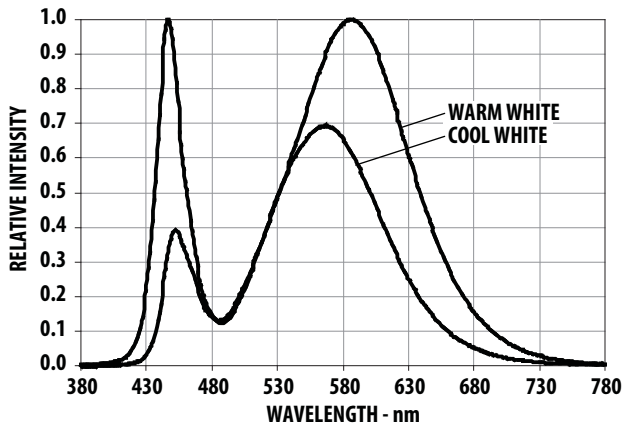

Figure 12. Relative Intensity vs. Wavelength for Cool and Warm White.

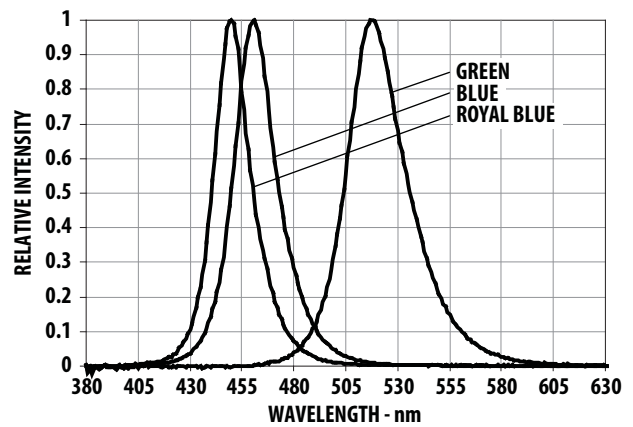

Figure 13. Relative Intensity vs. Wavelength for Blue and Green.

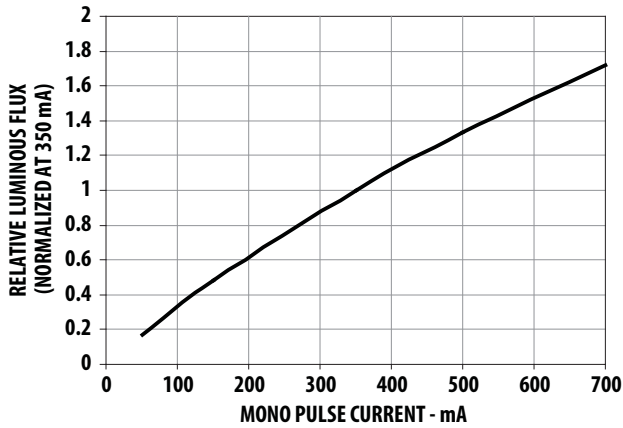

Figure 14. Relative Luminous Flux vs. Mono Pulse Current.

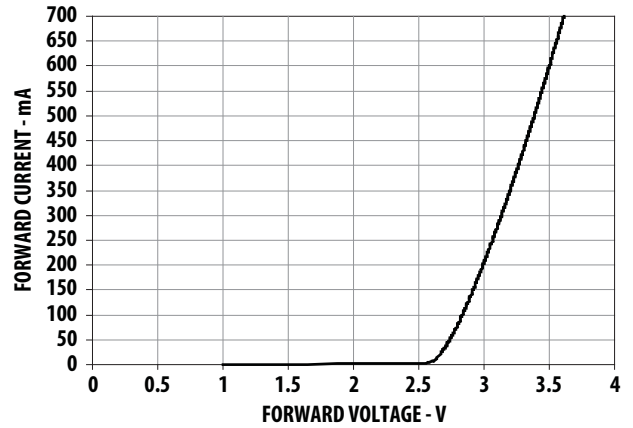

Figure 15. Forward Current vs. Forward Voltage.

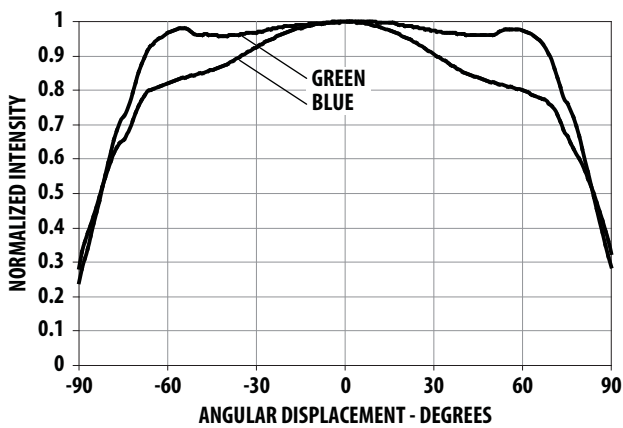

Figure 16. Radiation Pattern for Blue and Green.

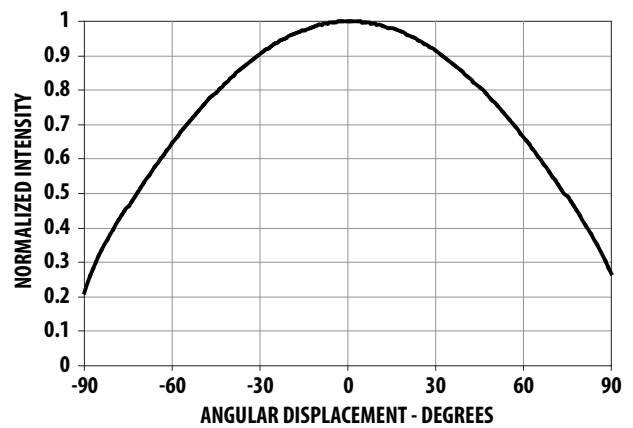

Figure 17. Radiation Pattern for Cool White and Warm White.

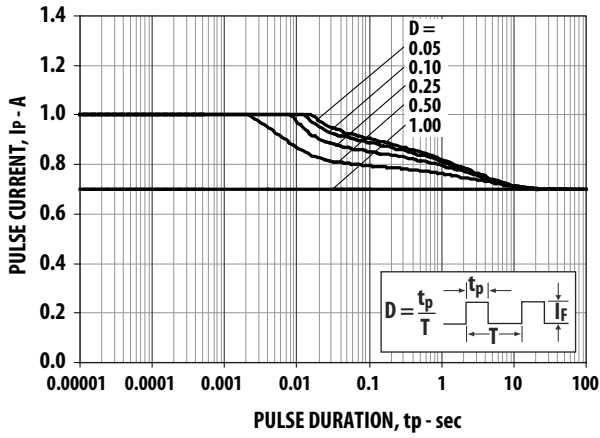

Figure 18. Maximum pulse current vs. ambient temperature.
Derated based on $T_A = 25^\circ\text{C}$, $R_{\theta J-A} = 30^\circ\text{C/W}$

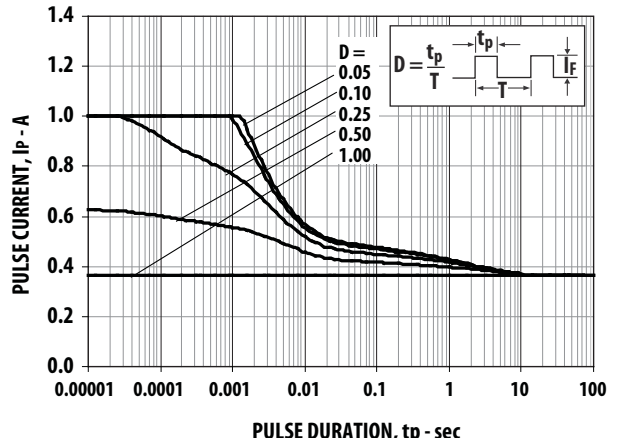

Figure 19. Maximum pulse current vs. ambient temperature.
Derated based on $T_A = 85^\circ\text{C}$, $R_{\theta J-A} = 30^\circ\text{C/W}$

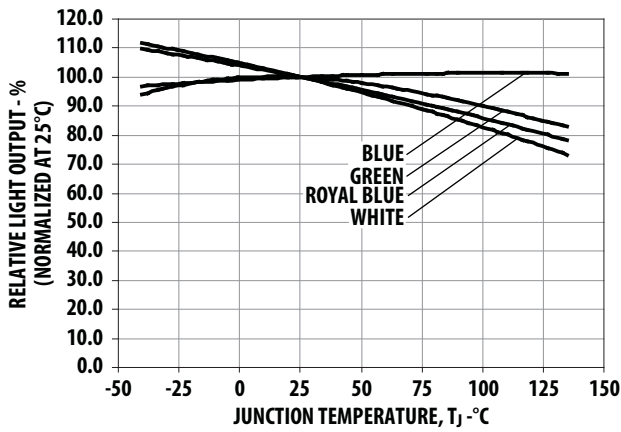

Figure 20. Relative Light Output vs. Junction Temperature.

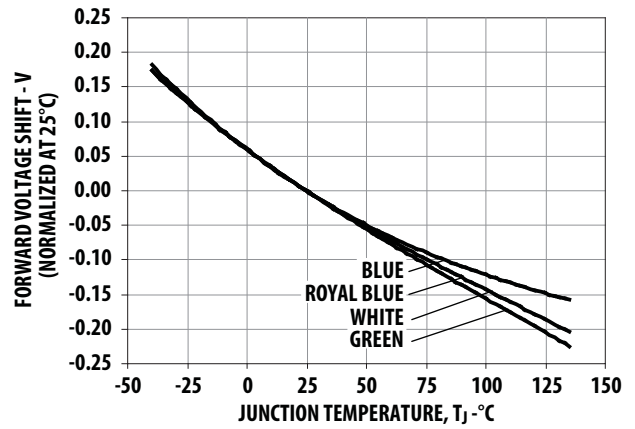

Figure 21. Forward Voltage Shift vs. Junction Temperature.

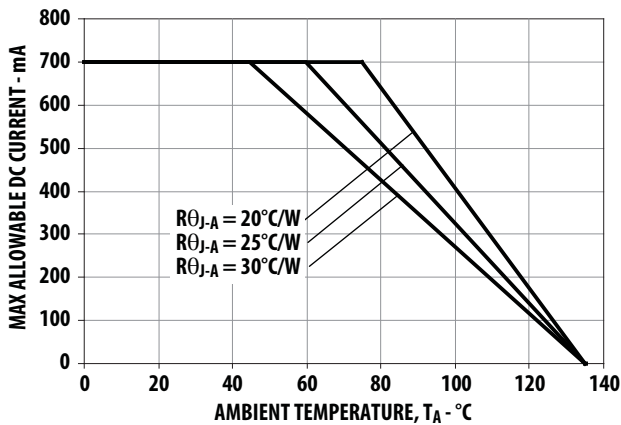

Figure 22. Maximum Forward Current vs. Ambient Temperature.
Derated based on $T_{JMAX} = 135^\circ\text{C}$, $R_{\theta J-A} = 20^\circ\text{C/W}$, 25°C/W and 30°C/W

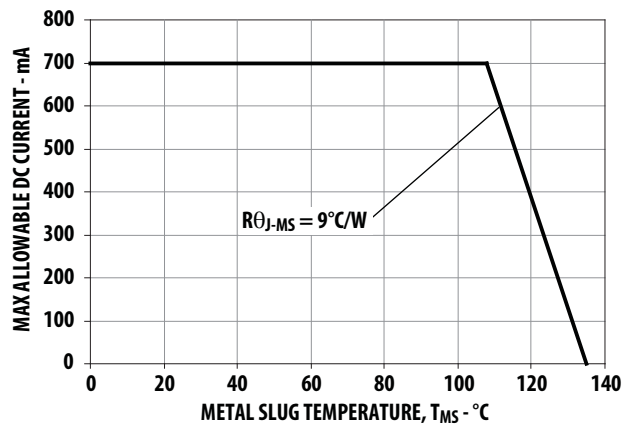

Figure 23. Maximum Forward Current vs. Metal Slug Temperature.
Derated based on $T_{JMAX} = 135^\circ\text{C}$, $R_{\theta J-MS} = 9^\circ\text{C/W}$

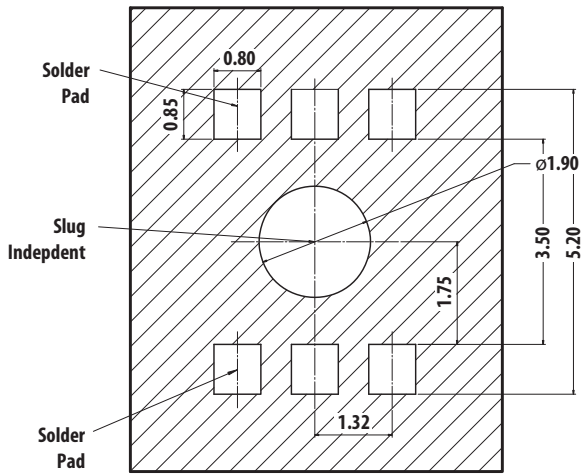

Figure 24. Recommended soldering land pattern

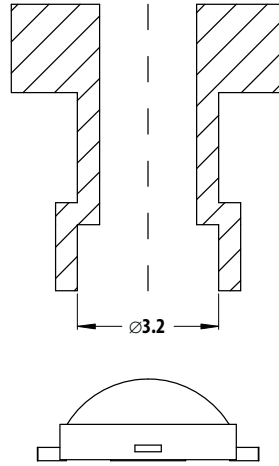

Figure 25. Recommended pick and place nozzle tip. Inner diameter = 3.2 mm

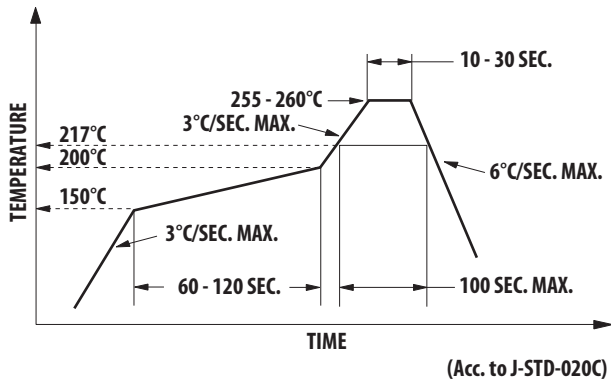

Figure 26. Recommended Reflow Soldering Profile

Note: For detail information on reflow soldering of Avago surface mount LEDs, do refer to Avago Application Note AN 1060 Surface Mounting SMT LED Indicator Components.

Option Selection Details

ASMT-J x₁ 3 x₂ – x₃ x₄ x₅ x₆ x₇

x₄ – Minimum Flux Bin Selection

x₅ – Maximum Flux Bin Selection

x₆ – Color Bin Selection

x₇ – Packaging Option

Flux Bin Limit [x₄, x₅]

Color	Bin ID	Luminous Flux (lm)/ Radiometric Power (mW) at 350 mA	
		Min.	Max.
Blue	M	13.9	18.1
	N	18.1	23.5
	P	23.5	30.6
	Q	30.6	39.8
Other Colors	R	39.8	51.7
	S	51.7	67.2
	T	67.2	87.4
	U	87.4	99.6
	V	99.6	113.6
Royal Blue	M	225.0	275.0
	N	275.0	355.0
	P	355.0	435.0
	Q	435.0	515.0

Tolerance for each bin limits is ±10%

Color Bin Selection (x₆)

Individual reel will contain parts from one color bin selection only.

Cool White

Selection	Bin ID
0	Full Distribution
E	VM, UM, VN and UN
F	WM, VM, WN and VN
G	XM, WM, XN and WN
H	UN, VN, U0 and V0
J	WN, VN, W0 and V0
K	XN, WN, X0 and W0
L	V0, U0, VP and UP
M	W0, V0, WP, VP and WQ
N	X0, W0, XP, WP and WQ
P	Y0
Q	YA

Neutral White

Selection	Bin ID
0	Full Distribution
E	SM, RM, S1 and R1
F	TM, SM, TN and S1
G	S1, R1, S0 and R0
H	TN, S1, T0 and S0
J	S0, R0, SA and RA
K	T0, S0, TP and SA

Warm White

Selection	Bin ID
0	Full Distribution
E	NM, MM, N1 and M1
F	PM, NM, P1 and N1
G	QM, PM, Q1 and P1
H	M1, N1, M0 and N0
J	P1, N1, P0 and N0
K	Q1, P1, Q0 and P0
L	N0, M0, NA and MA
M	P0, N0, PA and NA
N	Q0, P0, QA and PA

Other Colors

Selection	Bin ID
0	Full Distribution
Z	A and B
Y	B and C
W	C and D
V	D and E
Q	A, B and C
P	B, C and D
N	C, D and E
M	D, E and F

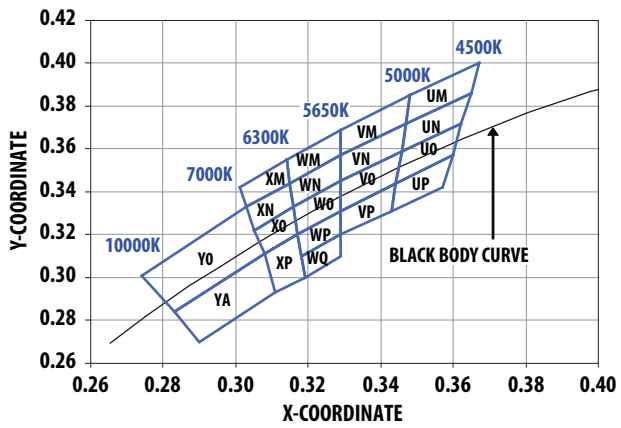

Figure 27. Color bin Structure for Cool White

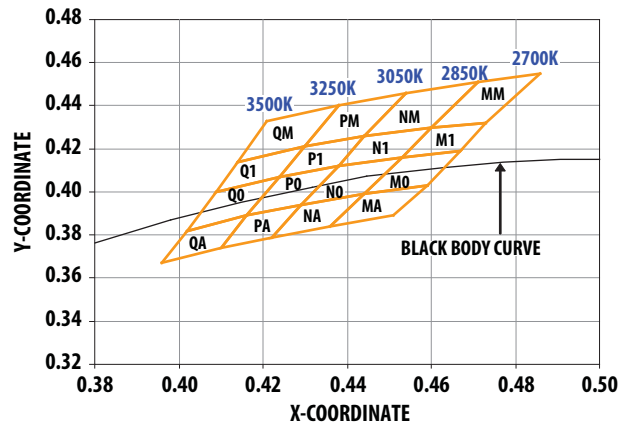

Figure 28. Color bin structure for Warm White

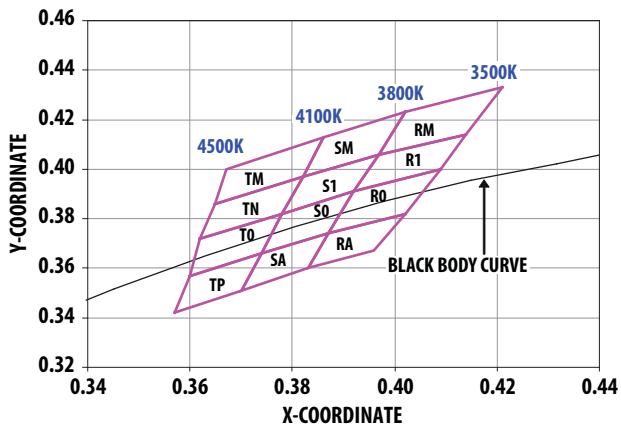

Figure 29. Color bin structure for Neutral White

Color Bin Limits

Cool White	Color Limits (Chromaticity Coordinates)				
		x	y		
Bin UM	x	0.365	0.367	0.348	0.347
	y	0.386	0.400	0.385	0.372
Bin UN	x	0.365	0.362	0.346	0.347
	y	0.386	0.372	0.359	0.372
Bin UO	x	0.362	0.360	0.344	0.346
	y	0.372	0.357	0.344	0.359
Bin UP	x	0.360	0.357	0.343	0.344
	y	0.357	0.342	0.331	0.344
Bin VM	x	0.329	0.329	0.348	0.347
	y	0.357	0.369	0.385	0.372
Bin VN	x	0.329	0.329	0.347	0.346
	y	0.345	0.357	0.372	0.359
Bin VO	x	0.329	0.329	0.346	0.344
	y	0.331	0.345	0.359	0.344
Bin VP	x	0.329	0.344	0.343	0.329
	y	0.331	0.344	0.331	0.320
Bin WM	x	0.329	0.329	0.315	0.314
	y	0.369	0.357	0.344	0.355
Bin WN	x	0.329	0.316	0.315	0.329
	y	0.345	0.333	0.344	0.357
Bin W0	x	0.329	0.329	0.317	0.316
	y	0.345	0.331	0.320	0.333
Bin WP	x	0.329	0.329	0.318	0.317
	y	0.331	0.320	0.310	0.320
Bin WQ	x	0.329	0.329	0.319	0.318
	y	0.320	0.310	0.300	0.310
Bin XM	x	0.301	0.314	0.315	0.303
	y	0.342	0.355	0.344	0.333
Bin XN	x	0.305	0.303	0.315	0.316
	y	0.322	0.333	0.344	0.333
Bin XO	x	0.308	0.305	0.316	0.317
	y	0.311	0.322	0.333	0.320
Bin XP	x	0.308	0.317	0.319	0.311
	y	0.311	0.320	0.300	0.293
Bin YO	x	0.308	0.283	0.274	0.303
	y	0.311	0.284	0.301	0.333
Bin YA	x	0.308	0.311	0.290	0.283
	y	0.311	0.293	0.270	0.284

Tolerance: ±0.01

Warm White	Color Limits (Chromaticity Coordinates)				
		x	y		
Bin MM	x	0.471	0.460	0.473	0.486
	y	0.451	0.430	0.432	0.455
Bin M1	x	0.460	0.453	0.467	0.473
	y	0.430	0.416	0.419	0.432
Bin M0	x	0.453	0.444	0.459	0.467
	y	0.416	0.399	0.403	0.419
Bin MA	x	0.459	0.444	0.436	0.451
	y	0.403	0.399	0.384	0.389
Bin NM	x	0.454	0.444	0.460	0.471
	y	0.446	0.426	0.430	0.451
Bin N1	x	0.444	0.438	0.453	0.460
	y	0.426	0.412	0.416	0.430
Bin N0	x	0.438	0.429	0.444	0.453
	y	0.412	0.394	0.399	0.416
Bin NA	x	0.444	0.429	0.422	0.436
	y	0.399	0.394	0.379	0.384
Bin PM	x	0.438	0.430	0.444	0.454
	y	0.440	0.421	0.426	0.446
Bin P1	x	0.430	0.424	0.438	0.444
	y	0.421	0.407	0.412	0.426
Bin P0	x	0.424	0.416	0.429	0.438
	y	0.407	0.389	0.394	0.412
Bin PA	x	0.429	0.416	0.410	0.422
	y	0.394	0.389	0.374	0.379
Bin QM	x	0.421	0.414	0.430	0.438
	y	0.433	0.414	0.421	0.440
Bin Q1	x	0.414	0.409	0.424	0.430
	y	0.414	0.400	0.407	0.421
Bin Q0	x	0.409	0.402	0.416	0.424
	y	0.400	0.382	0.389	0.407
Bin QA	x	0.416	0.402	0.396	0.410
	y	0.389	0.382	0.367	0.374

Tolerance: ±0.01

Neutral White	Color Limits (Chromaticity Coordinates)				
		x	y	z	u
Bin RM	x	0.421	0.414	0.397	0.402
	y	0.433	0.414	0.406	0.423
Bin R1	x	0.414	0.409	0.392	0.397
	y	0.414	0.400	0.391	0.406
Bin R0	x	0.392	0.387	0.402	0.409
	y	0.391	0.374	0.382	0.400
Bin RA	x	0.387	0.383	0.396	0.402
	y	0.374	0.360	0.367	0.382
Bin SM	x	0.402	0.397	0.382	0.386
	y	0.423	0.406	0.397	0.413
Bin S1	x	0.397	0.392	0.378	0.382
	y	0.406	0.391	0.382	0.397
Bin S0	x	0.392	0.387	0.374	0.378
	y	0.391	0.374	0.366	0.382
Bin SA	x	0.387	0.383	0.370	0.374
	y	0.374	0.360	0.351	0.366
Bin TM	x	0.386	0.382	0.365	0.367
	y	0.413	0.397	0.386	0.400
Bin TN	x	0.382	0.378	0.362	0.365
	y	0.397	0.382	0.372	0.386
Bin T0	x	0.378	0.374	0.360	0.362
	y	0.382	0.366	0.357	0.372
Bin TP	x	0.374	0.370	0.357	0.360
	y	0.366	0.351	0.342	0.357

Tolerance: ±0.01

Packaging Option [x₇]

Selection	Option
1	Tape and Reel

Color	Bin ID	Dominant Wavelength (nm) at 350 mA	
		Min.	Max.
Red	–	620.0	635.0
Red Orange	–	610.0	620.0
Amber	B	587.0	589.5
	C	589.5	592.0
	D	592.0	594.5
	E	594.5	597.0
	Blue	A	460.0
Blue	B	465.0	470.0
	C	470.0	475.0
	D	475.0	480.0
	Green	A	515.0
Green	B	520.0	525.0
	C	525.0	530.0
	D	530.0	535.0

Tolerance: ±1 nm

Color	Bin ID	Peak Wavelength (nm) at 350 mA	
		Min.	Max.
Royal Blue	C	440.0	445.0
	D	445.0	450.0
	E	450.0	455.0
	F	455.0	460.0

Tolerance: ±2 nm

Example

ASMT-JG31-NST01

ASMT-JG31-Nxxxx – Green, InGaN, Electrically isolated Heat Sink

- X₄ = S – Minimum Flux Bin S
- X₅ = T – Maximum Flux Bin T
- X₆ = 0 – Full Distribution
- X₇ = 1 – Tape and Reel Option

Tape and Reel – Option 1

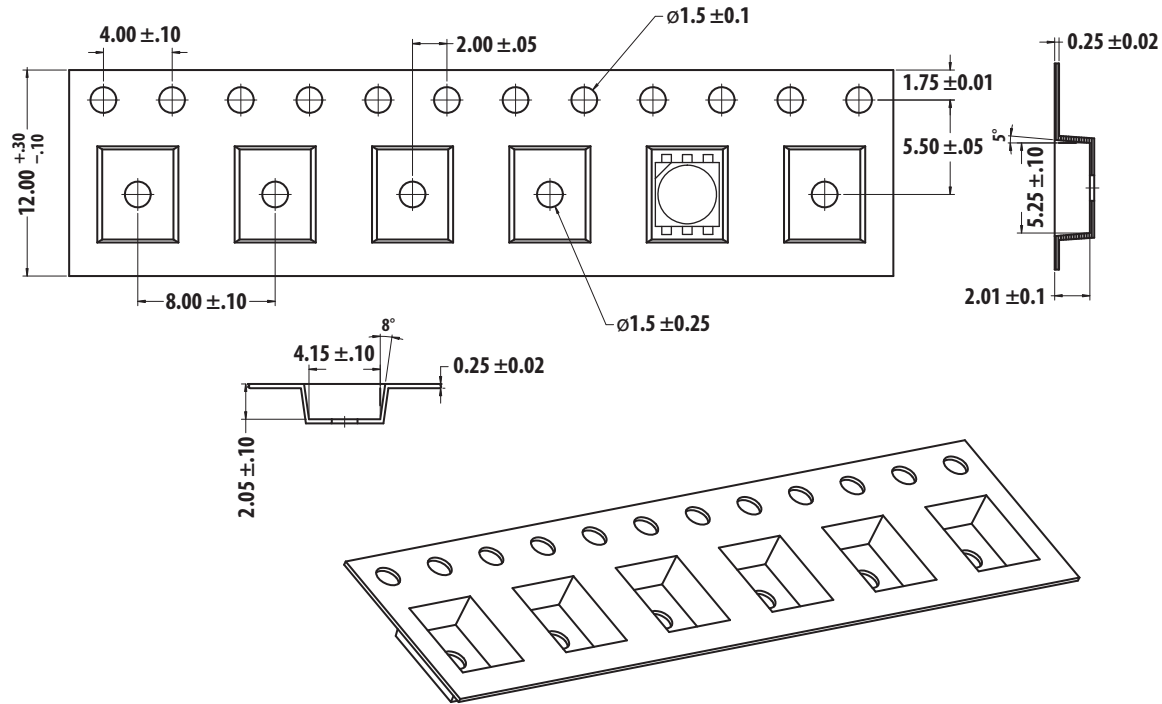
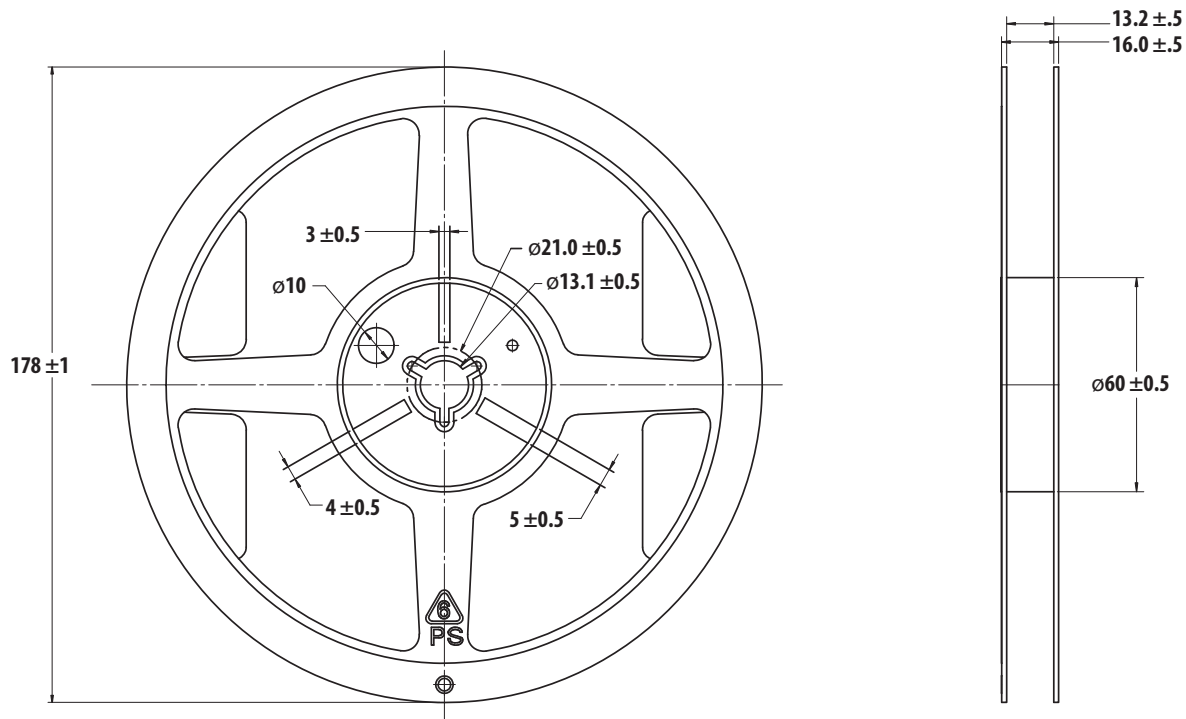

Figure 30. Carrier Tape Dimensions



Notes:

1. Empty component pockets sealed with top cover tape.
2. 250 or 500 pieces per reel.
3. Drawing not to scale.
4. All dimensions are in millimeters.

Figure 31. Reel dimensions

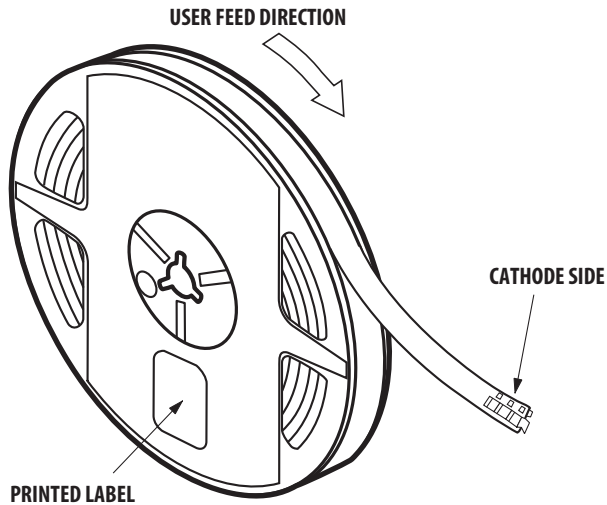

Figure 32. Reeling Orientation

DISCLAIMER: Avago's products and software are not specifically designed, manufactured or authorized for sale as parts, components or assemblies for the planning, construction, maintenance or direct operation of a nuclear facility or for use in medical devices or applications. Customer is solely responsible, and waives all rights to make claims against avago or its suppliers, for all loss, damage, expense or liability in connection with such use.

For product information and a complete list of distributors, please go to our web site: www.avagotech.com

Avago, Avago Technologies, and the A logo are trademarks of Avago Technologies in the United States and other countries. Data subject to change. Copyright © 2005-2010 Avago Technologies. All rights reserved.
AV02-1941EN - June 28, 2010

AVAGO
TECHNOLOGIES