

THROUGH-HOLE RESISTORS 2013





4	Metal Film Resistors	General Type	[MFR Series]
6	Metal Film Resistors	Precision Type	[MFP Series]
8	Metal Film Resistors	Professional Type	[MFO Series]
10	Metal Film Resistors	Flame-Proof Type	[FMF Series]
12	Metal Film Resistors	Professional & Flame-Proof Type	[FM0 Series]
14	Metal Film Resistors	High Power & Flame-Proof Type	[FMP Series]
16	Metal Film Resistors	Fusible & Flame-Proof Type	[FRM Series]
18	HID Lamp Resistors	HID Lamp Type	[HTM / HTR Series]
20	Metal Oxide Film Resistors	Flame-Proof Type	[RSF Series]
22	Melf Metal Film Resistors	General Type	[MMF Series]
24	Melf Metal Film Resistors	High Power Type	[MMP Series]
26	Carbon Film Resistors	General Type	[CFR Series]
28	Carbon Film Resistors	Professional Type	[CFO Series]
30	Carbon Film Resistors	Flame-Proof Type	[FCR Series]
32	Carbon Film Resistors	Professional & Flame-Proof Type	[FCO Series]
34	Carbon Film Resistors	Non-Inductive & Flame-Proof Type	[NCR Series]
36	Melf Carbon Film Resistors	General Type	[MCF Series]
38	Melf Carbon Film Resistors	High Power Type	[MCP Series]
40	Metal Glazed Film Resistors	High Voltage & High Ohmic Type	[HHV Series]
42	Pulse-Loading Resistors	Anti-Pulse Type	[APR Series]
44	Zero Ohm Resistors	Coating Type	[ZOR Series]
45	Jumper Wires	Tinned-Copper Wire Type	[JPW Series]
46	Low Ohmic Wire Resistors	Alloy-Wire Type	[MCW Series]
48	Wirewound Resistors	General Type	[KNP Series]
50	Wirewound Resistors	Flame-Proof & Non-Inductive Type	[NKN Series]
52	Wirewound Resistors	Fusible & Flame-Proof Type	[FKN Series]
54	Wirewound Resistors	High Power Type	[PNP Series]
56	Wirewound Resistors	High Power Type	[PNPV Series]
58	Wirewound Resistors	Fusible & Anti-Explosion Type	[FAE Series]
60	Cement Resistors	Axial Lead Type	[SQP / NSP Series]
62	Cement Resistors	Vertical Lead Type	[SQM / NSM Series]
64	Cement Resistors	Radial Terminal Type	[SQZ / NSZ Series]
66	Fiberglass Cement Resistors	Power Wirewound & Axial Lead Type	[PSP Series]
68	Fiberglass Cement Resistors	Power Wirewound & Vertical Lead Type	[PSM Series]
70	Fiberglass Cement Resistors	Circuit Breaker & Axial Lead Type	[FSP Series]
72	Fiberglass Cement Resistors	Circuit Breaker & Vertical Lead Type	[FSM Series]
74	Cement Resistors	Fusible Thermal & Vertical Lead Type	[FTR Series]
76	Cement Resistors	Low Ohmic Metal Plate Type	[SLR Series]
78	Aluminum Housed Resistors	Power Wirewound Type	[AHA / AHP Series]
80	Aluminum Housed Resistors	High Power Wirewound Type	[AHB Series]
82	General Information		

Metal Film Resistors

General Type

Normal & Miniature Style [MFR Series]

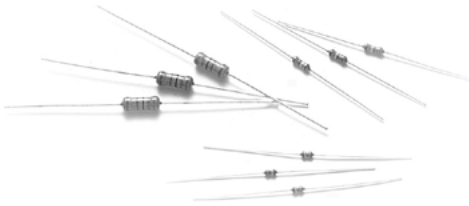

INTRODUCTION

The MFR Series Metal Film Resistors are manufactured using a vacuum sputtering system to deposit multiple layers of mixed metal alloys and passivative materials onto a carefully treated high grade ceramic substrate. After a helical groove has been cut in the resistive layer, tinned connecting leads of electrolytic copper are welded to the end-caps. The resistors are coated with layers of blue color lacquer.

FEATURES

Power Rating	1/6W, 1/4W, 1/2W, 1W, 2W, 3W
Resistance Tolerance	±0.5%, ±1%, ±5%
T.C.R.	±15ppm/°C, ±25ppm/°C, ±50ppm/°C, ±100ppm/°C

DERATING CURVE

For resistors operated in ambient temperatures above 70°C, power rating must be derated in accordance with the curve below.

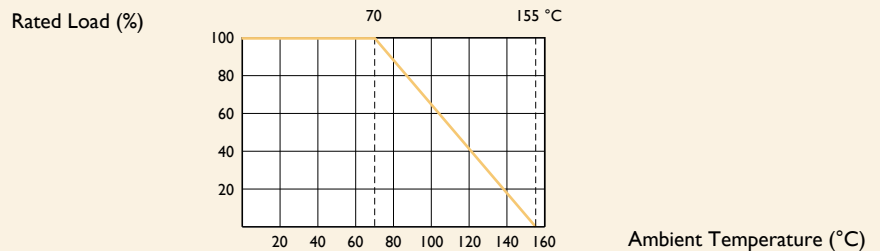

DIMENSIONS

Unit: mm

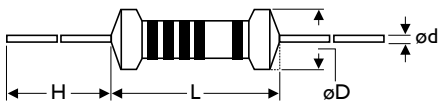

STYLE		DIMENSION			
Normal	Miniature	L	øD	H	ød
MFR-12	MFR25S	3.4±0.3	1.9±0.2	28±2.0	0.45±0.05
MFR-25	MFR50S	6.3±0.5	2.4±0.2	28±2.0	0.55±0.05
MFR-50	MFR1WS	9.0±0.5	3.3±0.3	26±2.0	0.55±0.05
MFR100	MFR2WS	11.5±1.0	4.5±0.5	35±2.0	0.8±0.05
MFR200	MFR3WS	15.5±1.0	5.0±0.5	33±2.0	0.8±0.05

Note:

ELECTRICAL CHARACTERISTICS

STYLE	MFR-12	MFR25S	MFR-25	MFR50S	MFR-50	MFRIWS	MFRI00	MFR2WS	MFR200	MFR3WS
Power Rating at 70°C	1/6W	1/4W		1/2W		1W		2W		3W
Maximum Working Voltage	200V		250V	300V	350V	400V	500V			
Maximum Overload Voltage	400V		500V	600V	700V	800V	1,000V			
Voltage Proof on Insulation	300V	400V	500V			700V	1,000V			
Resistance Range	1Ω - 10MΩ & 0Ω for E24 & E96 series value									
Operating Temp. Range	-55°C to +155°C									
Temperature Coefficient	±15ppm/°C, ±25ppm/°C, ±50ppm/°C, ±100ppm/°C									

Note: Special value is available on request

ENVIRONMENTAL CHARACTERISTICS

PERFORMANCE TEST	TEST METHOD		APPRAISE
Short Time Overload	IEC 60115-1 4.13	2.5 times RCWV for 5 Sec.	±0.25%+0.05Ω
Voltage Proof on Insulation	IEC 60115-1 4.7	in V-block for 60 Sec., test voltage by type	By type
Temperature Coefficient	IEC 60115-1 4.8	-55°C to +155°C	By type
Insulation Resistance	IEC 60115-1 4.6	in V-block for 60 Sec.	>10,000MΩ
Solderability	IEC 60115-1 4.17	235±5°C for 3±0.5 Sec.	95% Min. coverage
Solvent Resistance of Marking	IEC 60115-1 4.30	IPA for 5±0.5 Min. with ultrasonic	No deterioration of coatings and markings
Robustness of Terminations	IEC 60115-1 4.16	Direct load for 10 Sec. in the direction of the terminal leads	≥2.5kg (24.5N)
Periodic-pulse Overload	IEC 60115-1 4.39	4 times RCWV 10,000 cycles (1 Sec. on, 25 Sec. off)	±1.0%+0.05Ω
Damp Heat Steady State	IEC 60115-1 4.24	40±2°C, 90-95% RH for 56 days, loaded with 0.1 times RCWV	±1.5%+0.05Ω
Endurance at 70°C	IEC 60115-1 4.25	70±2°C at RCWV for 1,000 Hr. (1.5 Hr. on, 0.5 Hr. off)	±1.5%+0.05Ω
Temperature Cycling	IEC 60115-1 4.19	-55°C ⇄ Room Temp. ⇄ +155°C ⇄ Room Temp. (5 cycles)	±0.75%+0.05Ω
Resistance to Soldering Heat	IEC 60115-1 4.18	260±3°C for 10±1 Sec., immersed to a point 3±0.5mm from the body	±0.25%+0.05Ω

Note: RCWV(Rated Continuous Working Voltage) = $\sqrt{\text{Power Rating} \times \text{Resistance Value}}$ or Max. working voltage listed above, whichever less.

Revision: 201304

Metal Film Resistors

Precision Type

Normal & Miniature Style [MFP Series]



INTRODUCTION

The MFP Series Metal Film Precision Resistors are manufactured using a vacuum sputtering system to deposit multiple layers of mixed metal alloys and passivative materials onto a carefully treated high grade ceramic substrate. After a helical groove has been cut in the resistive layer, tinned connecting leads of electrolytic copper are welded to the end-caps. The resistors are coated with layers of blue color lacquer. Ultra high precision resistors, ultra high stability, ultra low temperature coefficient.

FEATURES

Power Rating	1/6W, 1/4W, 0.4W, 1/2W, 0.6W, 1W, 2W, 3W
Resistance Tolerance	±0.1%, ±0.25%, (±0.02%, ±0.05% on request)
T.C.R.	±15ppm/°C, ±25ppm/°C, (±5ppm/°C, ±10ppm/°C on request)

DERATING CURVE

For resistors operated in ambient temperatures above 70°C, power rating must be derated in accordance with the curve below.

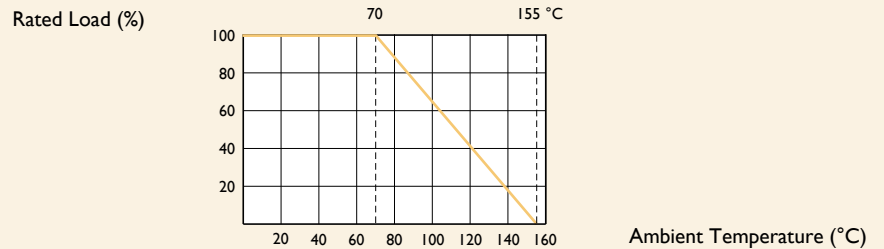

DIMENSIONS

Unit: mm

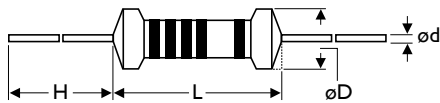

STYLE		DIMENSION			
Normal	Miniature	L	øD	H	ød
MFP-12	MFP25S	3.4±0.3	1.9±0.2	28±2.0	0.45±0.05
MFP204	-	3.4±0.3	1.9±0.2	28±2.0	0.45±0.05
MFP-25	MFP50S	6.3±0.5	2.4±0.2	28±2.0	0.55±0.05
MFP207	-	6.3±0.5	2.4±0.2	28±2.0	0.55±0.05
MFP-50	MFP1WS	9.0±0.5	3.3±0.3	26±2.0	0.55±0.05
MFP100	MFP2WS	11.5±1.0	4.5±0.5	35±2.0	0.8±0.05
MFP200	MFP3WS	15.5±1.0	5.0±0.5	33±2.0	0.8±0.05

Note:

ELECTRICAL CHARACTERISTICS

STYLE	MFP-12	MFP25S	MFP204	MFP-25	MFP50S	MFP207	MFP-50	MFPIWS	MFP100	MFP2WS	MFP200	MFP3WS
Power Rating at 70°C	1/6W	1/4W	0.4W	1/4W	1/2W	0.6W	1/2W	1W		2W		3W
Maximum Working Voltage	150V	200V		250V			350V	400V	500V			
Maximum Overload Voltage	300V	400V		500V	600V		700V	800V	1,000V			
Voltage Proof on Insulation	300V			500V				700V	1,000V			
Resistance Range	10Ω - 1 MΩ for E192 series value											
Operating Temp. Range	-55°C to +155°C											
Temperature Coefficient	±15ppm/°C, ±25ppm/°C											

Note: Special value is available on request

ENVIRONMENTAL CHARACTERISTICS

PERFORMANCE TEST	TEST METHOD		APPRAISE
Short Time Overload	IEC 60115-1 4.13	2.5 times RCWV for 5 Sec.	±0.25%+0.05Ω
Voltage Proof on Insulation	IEC 60115-1 4.7	in V-block for 60 Sec., test voltage by type	By type
Temperature Coefficient	IEC 60115-1 4.8	-55°C to +155°C	By type
Insulation Resistance	IEC 60115-1 4.6	in V-block for 60 Sec.	>10,000MΩ
Solderability	IEC 60115-1 4.17	235±5°C for 3±0.5 Sec.	95% Min. coverage
Solvent Resistance of Marking	IEC 60115-1 4.30	IPA for 5±0.5 Min. with ultrasonic	No deterioration of coatings and markings
Robustness of Terminations	IEC 60115-1 4.16	Direct load for 10 Sec. in the direction of the terminal leads	≥2.5kg (24.5N)
Periodic-pulse Overload	IEC 60115-1 4.39	4 times RCWV 10,000 cycles (1 Sec. on, 25 Sec. off)	±1.0%+0.05Ω
Damp Heat Steady State	IEC 60115-1 4.24	40±2°C, 90-95% RH for 56 days, loaded with 0.1 times RCWV	±1.5%+0.05Ω
Endurance at 70°C	IEC 60115-1 4.25	70±2°C at RCWV for 1,000 Hr. (1.5 Hr. on, 0.5 Hr. off)	±1.5%+0.05Ω
Temperature Cycling	IEC 60115-1 4.19	-55°C ⇌ Room Temp. ⇌ +155°C ⇌ Room Temp. (5 cycles)	±0.75%+0.05Ω
Resistance to Soldering Heat	IEC 60115-1 4.18	260±3°C for 10±1 Sec., immersed to a point 3±0.5mm from the body	±0.25%+0.05Ω

Note: RCWV(Rated Continuous Working Voltage) = $\sqrt{\text{Power Rating} \times \text{Resistance Value}}$ or Max. working voltage listed above, whichever less.

Revision: 201304

Metal Film Resistors

Professional Type

Miniature Style [MF0 Series]

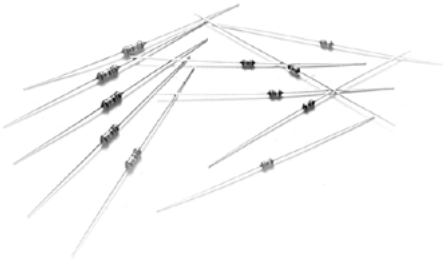

INTRODUCTION

The MF0 Series Metal Film Professional Resistors are manufactured using a vacuum sputtering system to deposit multiple layers of mixed metal alloys and passivative materials onto a carefully treated high grade ceramic substrate. After a helical groove has been cut in the resistive layer; tinned connecting leads of electrolytic copper are welded to the end-caps. The resistors are coated with layers of blue color lacquer.

FEATURES

Power Rating	0.4W, 0.6W
Resistance Tolerance	±0.5%, ±1%, ±5%
T.C.R.	±50ppm/°C

DERATING CURVE

For resistors operated in ambient temperatures above 70°C, power rating must be derated in accordance with the curve below.

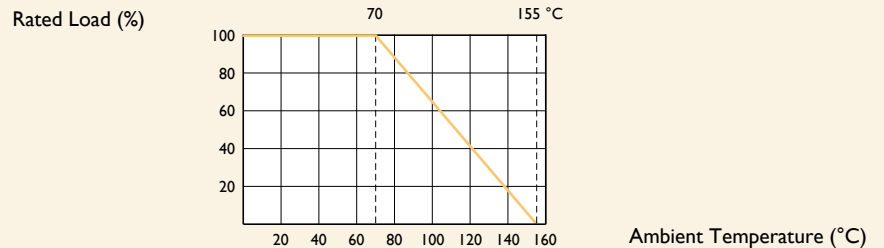

DIMENSIONS

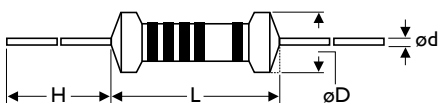

Unit: mm

STYLE	DIMENSION			
	L	øD	H	ød
Miniature				
MF0204	3.4±0.3	1.9±0.2	28±2.0	0.45±0.05
MF0207	6.3±0.5	2.4±0.2	28±2.0	0.55±0.05

Note:

ELECTRICAL CHARACTERISTICS

STYLE	MF0204	MF0207
Power Rating at 70°C	0.4W	0.6W
Maximum Working Voltage	250V	350V
Maximum Overload Voltage	500V	700V
Voltage Proof on Insulation	300V	500V
Resistance Range	1Ω - 10MΩ & 0Ω for E24 & E96 series value	
Operating Temp. Range	-55°C to +155°C	
Temperature Coefficient	±50ppm/°C	

Note: Special value is available on request

ENVIRONMENTAL CHARACTERISTICS

PERFORMANCE TEST	TEST METHOD		APPRAISE
Short Time Overload	IEC 60115-1 4.13	2.5 times RCWV for 5 Sec.	±0.25%+0.05Ω
Voltage Proof on Insulation	IEC 60115-1 4.7	in V-block for 60 Sec., test voltage by type	By type
Temperature Coefficient	IEC 60115-1 4.8	-55°C to +155°C	By type
Insulation Resistance	IEC 60115-1 4.6	in V-block for 60 Sec.	>10,000MΩ
Solderability	IEC 60115-1 4.17	235±5°C for 3±0.5 Sec.	95% Min. coverage
Solvent Resistance of Marking	IEC 60115-1 4.30	IPA for 5±0.5 Min. with ultrasonic	No deterioration of coatings and markings
Robustness of Terminations	IEC 60115-1 4.16	Direct load for 10 Sec. in the direction of the terminal leads	≥2.5kg (24.5N)
Periodic-pulse Overload	IEC 60115-1 4.39	4 times RCWV 10,000 cycles (1 Sec. on, 25 Sec. off)	±1.0%+0.05Ω
Damp Heat Steady State	IEC 60115-1 4.24	40±2°C, 90-95% RH for 56 days, loaded with 0.1 times RCWV	±1.5%+0.05Ω
Endurance at 70°C	IEC 60115-1 4.25	70±2°C at RCWV for 1,000 Hr. (1.5 Hr. on, 0.5 Hr. off)	±1.5%+0.05Ω
Temperature Cycling	IEC 60115-1 4.19	-55°C ⇌ Room Temp. ⇌ +155°C ⇌ Room Temp. (5 cycles)	±0.75%+0.05Ω
Resistance to Soldering Heat	IEC 60115-1 4.18	260±3°C for 10±1 Sec., immersed to a point 3±0.5mm from the body	±0.25%+0.05Ω

Note: RCWV(Rated Continuous Working Voltage) = $\sqrt{\text{Power Rating} \times \text{Resistance Value}}$ or Max. working voltage listed above, whichever less.

Revision: 201304

Metal Film Resistors

Flame-Proof Type

Normal & Miniature Style [FMF Series]

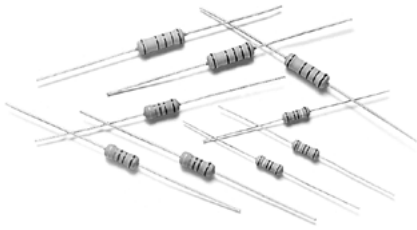

INTRODUCTION

The FMF Series Metal Film Flame-Proof Resistors are manufactured using a vacuum sputtering system to deposit multiple layers of mixed metal alloys and passivative materials onto a carefully treated high grade ceramic substrate. After a helical groove has been cut in the resistive layer; tinned connecting leads of electrolytic copper are welded to the end-caps. The resistors are coated with layers of gray color lacquer.

FEATURES

Power Rating	1/4W, 1/2W, 1W, 2W, 3W
Resistance Tolerance	±1%
T.C.R.	±50ppm/°C, ±100ppm/°C
Flameproof Multi-layer Coating Meets	UL-94V-0
Flameproof Feature Meets Overload Test	UL-1412

DERATING CURVE

For resistors operated in ambient temperatures above 70°C, power rating must be derated in accordance with the curve below.

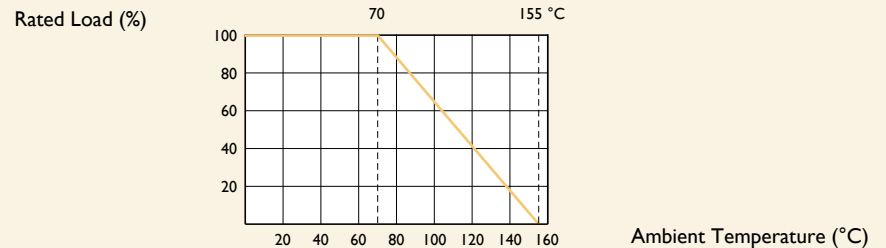

DIMENSIONS

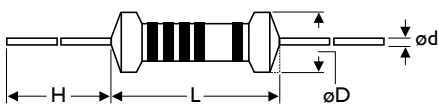

Unit: mm

STYLE		DIMENSION			
Normal	Miniature	L	øD	H	ød
FMF-25	FMF50S	6.3±0.5	2.4±0.2	28±2.0	0.55±0.05
FMF-50	FMF1WS	9.0±0.5	3.3±0.3	26±2.0	0.55±0.05
FMF100	FMF2WS	11.5±1.0	4.5±0.5	35±2.0	0.8±0.05
FMF200	FMF3WS	15.5±1.0	5.0±0.5	33±2.0	0.8±0.05

Note:

ELECTRICAL CHARACTERISTICS

STYLE	FMF-25	FMF50S	FMF-50	FMFIWS	FMFI00	FMF2WS	FMF200	FMF3WS
Power Rating at 70°C	1/4W	1/2W		1W		2W		3W
Maximum Working Voltage	250V	300V	350V	400V	500V			
Maximum Overload Voltage	500V	600V	700V	800V	1,000V			
Voltage Proof on Insulation	400V		500V					
Resistance Range	1Ω - 10MΩ & 0Ω for E24 & E96 series value							
Operating Temp. Range	-55°C to +155°C							
Temperature Coefficient	±50ppm/°C, ±100ppm/°C							

Note: Special value is available on request

ENVIRONMENTAL CHARACTERISTICS

PERFORMANCE TEST	TEST METHOD		APPRAISE
Short Time Overload	IEC 60115-1 4.13	2.5 times RCWV for 5 Sec.	±0.25%+0.05Ω
Voltage Proof on Insulation	IEC 60115-1 4.7	in V-block for 60 Sec., test voltage by type	By type
Temperature Coefficient	IEC 60115-1 4.8	-55°C to +155°C	By type
Insulation Resistance	IEC 60115-1 4.6	in V-block for 60 Sec.	>1,000MΩ
Solderability	IEC 60115-1 4.17	235±5°C for 3±0.5 Sec.	95% Min. coverage
Solvent Resistance of Marking	IEC 60115-1 4.30	IPA for 5±0.5 Min. with ultrasonic	No deterioration of coatings and markings
Robustness of Terminations	IEC 60115-1 4.16	Direct load for 10 Sec. in the direction of the terminal leads	≥2.5kg (24.5N)
Periodic-pulse Overload	IEC 60115-1 4.39	4 times RCWV 10,000 cycles (1 Sec. on, 25 Sec. off)	±1.0%+0.05Ω
Damp Heat Steady State	IEC 60115-1 4.24	40±2°C, 90-95% RH for 56 days, loaded with 0.1 times RCWV	±1.5%+0.05Ω
Endurance at 70°C	IEC 60115-1 4.25	70±2°C at RCWV for 1,000 Hr. (1.5 Hr. on, 0.5 Hr. off)	±1.5%+0.05Ω
Temperature Cycling	IEC 60115-1 4.19	-55°C ⇌ Room Temp. ⇌ +155°C ⇌ Room Temp. (5 cycles)	±0.75%+0.05Ω
Resistance to Soldering Heat	IEC 60115-1 4.18	260±3°C for 10±1 Sec., immersed to a point 3±0.5mm from the body	±0.25%+0.05Ω
Accidental Overload Test	IEC 60115-1 4.26	4 times RCWV for 1 Min.	No evidence of flaming or arcing

Note: RCWV(Rated Continuous Working Voltage) = $\sqrt{\text{Power Rating} \times \text{Resistance Value}}$ or Max. working voltage listed above, whichever less.

Revision: 201304

Metal Film Resistors

Professional & Flame-Proof Type

Miniature Style [FM0 Series]

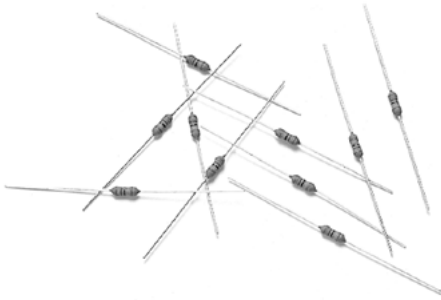

INTRODUCTION

The FM0 Series Metal Film Professional & Flame-Proof Resistors are manufactured using a vacuum sputtering system to deposit multiple layers of mixed metal alloys and passivative materials onto a carefully treated high grade ceramic substrate. After a helical groove has been cut in the resistive layer; tinned connecting leads of electrolytic copper are welded to the end-caps. The resistors are coated with layers of light green color lacquer.

FEATURES

Power Rating	0.4W, 0.6W
Resistance Tolerance	±1%, ±5%
T.C.R.	±50ppm/°C
Flameproof Multi-layer Coating Meets	UL-94V-0
Flameproof Feature Meets Overload Test	UL-1412

DERATING CURVE

For resistors operated in ambient temperatures above 70°C, power rating must be derated in accordance with the curve below.

Rated Load (%)

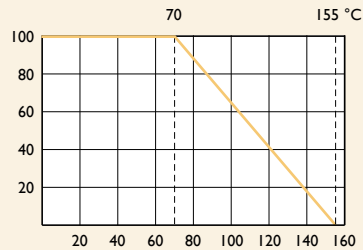

Ambient Temperature (°C)

DIMENSIONS

Unit: mm

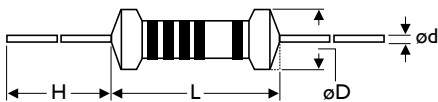

STYLE	DIMENSION			
	L	øD	H	ød
Miniature				
FM0204	3.4±0.3	1.9±0.2	28±2.0	0.45±0.05
FM0207	6.3±0.5	2.4±0.2	28±2.0	0.55±0.05

Note:

ELECTRICAL CHARACTERISTICS

STYLE	FM0204	FM0207
Power Rating at 70°C	0.4W	0.6W
Maximum Working Voltage	200V	300V
Maximum Overload Voltage	400V	600V
Voltage Proof on Insulation	300V	500V
Resistance Range	1Ω - 10MΩ & 0Ω for E24 & E96 series value	
Operating Temp. Range	-55°C to +155°C	
Temperature Coefficient	±50ppm/°C	

Note: Special value is available on request

ENVIRONMENTAL CHARACTERISTICS

PERFORMANCE TEST	TEST METHOD	APPRAISE
Short Time Overload	IEC 60115-1 4.13 2.5 times RCWV for 5 Sec.	±0.25%+0.05Ω
Voltage Proof on Insulation	IEC 60115-1 4.7 in V-block for 60 Sec., test voltage by type	By type
Temperature Coefficient	IEC 60115-1 4.8 -55°C to +155°C	By type
Insulation Resistance	IEC 60115-1 4.6 in V-block for 60 Sec.	>1,000MΩ
Solderability	IEC 60115-1 4.17 235±5°C for 3±0.5 Sec.	95% Min. coverage
Solvent Resistance of Marking	IEC 60115-1 4.30 IPA for 5±0.5 Min. with ultrasonic	No deterioration of coatings and markings
Robustness of Terminations	IEC 60115-1 4.16 Direct load for 10 Sec. in the direction of the terminal leads	≥2.5kg (24.5N)
Periodic-pulse Overload	IEC 60115-1 4.39 4 times RCWV 10,000 cycles (1 Sec. on, 25 Sec. off)	±1.0%+0.05Ω
Damp Heat Steady State	IEC 60115-1 4.24 40±2°C, 90-95% RH for 56 days, loaded with 0.1 times RCWV	±1.5%+0.05Ω
Endurance at 70°C	IEC 60115-1 4.25 70±2°C at RCWV for 1,000 Hr. (1.5 Hr. on, 0.5 Hr. off)	±1.5%+0.05Ω
Temperature Cycling	IEC 60115-1 4.19 -55°C ⇌ Room Temp. ⇌ +155°C ⇌ Room Temp. (5 cycles)	±0.75%+0.05Ω
Resistance to Soldering Heat	IEC 60115-1 4.18 260±3°C for 10±1 Sec., immersed to a point 3±0.5mm from the body	±0.25%+0.05Ω
Accidental Overload Test	IEC 60115-1 4.26 4 times RCWV for 1 Min.	No evidence of flaming or arcing

Note: RCWV(Rated Continuous Working Voltage) = $\sqrt{\text{Power Rating} \times \text{Resistance Value}}$ or Max. working voltage listed above, whichever less.

Metal Film Resistors

High Power & Flame-Proof Type

Ultra Miniature Style [FMP Series]

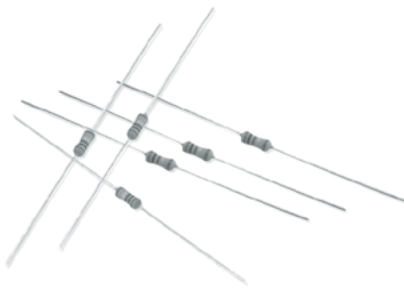

INTRODUCTION

The FMP Series Metal Film High Power Resistors are manufactured using a vacuum sputtering system to deposit multiple layers of mixed metal alloys and passivative materials onto a carefully treated high grade ceramic substrate. After a helical groove has been cut in the resistive layer; tinned connecting leads of electrolytic copper are welded to the end-caps. The resistors are coated with layers of pink color lacquer.

FEATURES

Power Rating	1/2W, 1W, 2W, 3W, 4W
Resistance Tolerance	±1%, ±5%
T.C.R.	±100ppm/°C
Flameproof Multi-layer Coating Meets	UL-94V-0
Flameproof Feature Meets Overload Test	UL-1412

DERATING CURVE

For resistors operated in ambient temperatures above 70°C, power rating must be derated in accordance with the curve below.

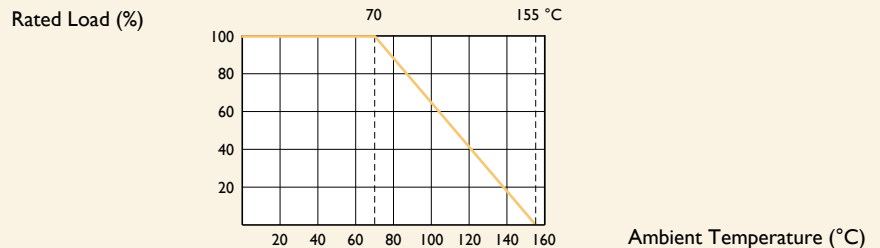

DIMENSIONS

Unit: mm

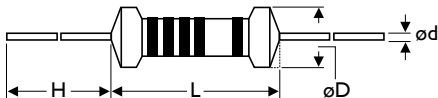

STYLE	DIMENSION			
	L	øD	H	ød
Ultra Miniature				
FMP-50	3.4±0.3	1.9±0.2	28±2.0	0.45±0.05
FMP100	6.3±0.5	2.4±0.2	28±2.0	0.55±0.05
FMP200	9.0±0.5	3.9±0.3	26±2.0	0.55±0.05
FMP3WS	11.5±1.0	4.5±0.5	35±2.0	0.8±0.05
FMP300	15.5±1.0	5.0±0.5	33±2.0	0.8±0.05
FMP4WV	17.0±1.0	7.5±0.5	32±2.0	0.8±0.05

Note:

ELECTRICAL CHARACTERISTICS

STYLE	FMP-50	FMP100	FMP200	FMP3WS	FMP300	FMP4WV
Power Rating at 70°C	1/2W	1W	2W	3W		4W
Maximum Working Voltage	200V	350V	500V		750V	
Maximum Overload Voltage	400V	600V	700V		1,000V	
Voltage Proof on Insulation	300V	500V				
Resistance Range	1Ω - 10MΩ & 0Ω for E24 & E96 series value					
Operating Temp. Range	-55°C to +155°C					
Temperature Coefficient	±100ppm/°C					

Note: Special value is available on request

ENVIRONMENTAL CHARACTERISTICS

PERFORMANCE TEST	TEST METHOD	APPRAISE
Short Time Overload	IEC 60115-1 4.13 2.5 times RCWV for 5 Sec.	±0.5%+0.05Ω
Voltage Proof on Insulation	IEC 60115-1 4.7 in V-block for 60 Sec., test voltage by type	By type
Temperature Coefficient	IEC 60115-1 4.8 -55°C to +155°C	By type
Insulation Resistance	IEC 60115-1 4.6 in V-block for 60 Sec.	>1,000MΩ
Solderability	IEC 60115-1 4.17 235±5°C for 3±0.5 Sec.	95% Min. coverage
Solvent Resistance of Marking	IEC 60115-1 4.30 IPA for 5±0.5 Min. with ultrasonic	No deterioration of coatings and markings
Robustness of Terminations	IEC 60115-1 4.16 Direct load for 10 Sec. in the direction of the terminal leads	≥2.5kg (24.5N)
Periodic-pulse Overload	IEC 60115-1 4.39 4 times RCWV 10,000 cycles (1 Sec. on, 25 Sec. off)	±1.0%+0.05Ω
Damp Heat Steady State	IEC 60115-1 4.24 40±2°C, 90-95% RH for 56 days, loaded with 0.1 times RCWV	±2.0%+0.05Ω
Endurance at 70°C	IEC 60115-1 4.25 70±2°C at RCWV for 1,000 Hr. (1.5 Hr. on, 0.5 Hr. off)	±2.0%+0.05Ω
Temperature Cycling	IEC 60115-1 4.19 -55°C ⇌ Room Temp. ⇌ +155°C ⇌ Room Temp. (5 cycles)	±1.0%+0.05Ω
Resistance to Soldering Heat	IEC 60115-1 4.18 260±3°C for 10±1 Sec., immersed to a point 3±0.5mm from the body	±0.25%+0.05Ω
Accidental Overload Test	IEC 60115-1 4.26 4 times RCWV for 1 Min.	No evidence of flaming or arcing

Note: RCWV(Rated Continuous Working Voltage) = $\sqrt{\text{Power Rating} \times \text{Resistance Value}}$ or Max. working voltage listed above, whichever less.

Revision: 201304

Metal Film Resistors

Fusible & Flame-Proof Type

Normal & Miniature Style [FRM Series]

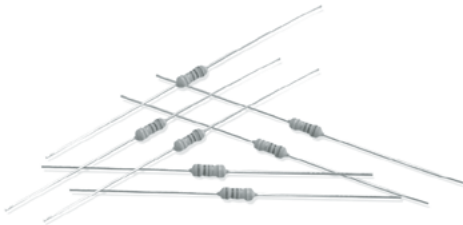

INTRODUCTION

The FRM Series Metal Film Fusible & Flame-Proof Resistors are manufactured using a vacuum sputtering system to deposit multiple layers of mixed metal alloys and passivative materials onto a carefully treated high grade ceramic substrate. After a helical groove has been cut in the resistive layer, tinned connecting leads of electrolytic copper are welded to the end-caps. The resistors are coated with layers of gray color lacquer for normal size & pink color lacquer for miniature size. Overload protection without risk of fire. Wide range of overload currents.

DIMENSIONS

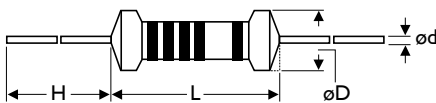

5th color code: white

FEATURES

Power Rating	1/4W, 1/2W, 1W, 2W, 3W
Resistance Tolerance	±2%, ±5%
T.C.R.	±200ppm/°C
Flameproof Multi-layer Coating Meets	UL-94V-0
Flameproof Feature Meets Overload Test	UL-1412

DERATING CURVE

For resistors operated in ambient temperatures above 70°C, power rating must be derated in accordance with the curve below.

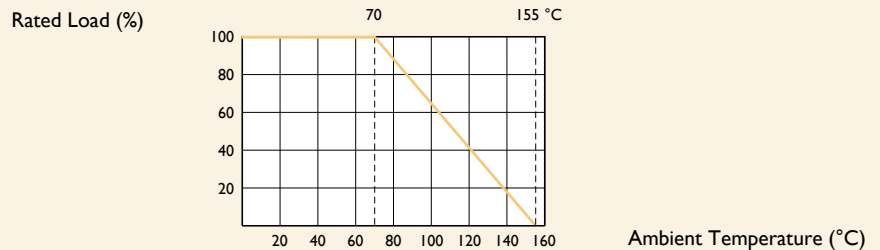

FUSING CHARACTERISTICS

$0.1 \leq R \leq 1\Omega$ Fusing time within 30 seconds at 36 times of rated power

$1 < R \leq 2.0\Omega$ Fusing time within 30 seconds at 25 times of rated power

$R \geq 2.2\Omega$ Fusing time within 30 seconds at 16 times of rated power

Fusing residual resistive value at least 100 times rated resistance

Unit: mm

STYLE		DIMENSION			
Normal	Miniature	L	øD	H	ød
FRM-25	FRM50S	6.3±0.5	2.4±0.2	28±2.0	0.55±0.05
FRM-50	FRM1WS	9.0±0.5	3.3±0.3	26±2.0	0.55±0.05
FRM100	FRM2WS	11.5±1.0	4.5±0.5	35±2.0	0.8±0.05
FRM200	FRM3WS	15.5±1.0	5.0±0.5	33±2.0	0.8±0.05

Note:

ELECTRICAL CHARACTERISTICS

STYLE	FRM-25	FRM50S	FRM-50	FRMIWS	FRMI00	FRM2WS	FRM200	FRM3WS
Power Rating at 70°C	1/4W	1/2W		1W		2W		3W
Maximum Working Voltage	$\sqrt{P \times R}$							
Voltage Proof on Insulation	250V				350V			
Resistance Range	1Ω - 560Ω (±2%) for E24 series value & 0.1Ω - 560Ω (±5%) for E24 series value							
Operating Temp. Range	-55°C to +155°C							
Temperature Coefficient	±200ppm/°C							

Note: Special value is available on request

ENVIRONMENTAL CHARACTERISTICS

PERFORMANCE TEST	TEST METHOD		APPRAISE
Short Time Overload	IEC 60115-1 4.13	2.5 times RCWV for 5 Sec.	±2.0%+0.05Ω
Voltage Proof on Insulation	IEC 60115-1 4.7	in V-block for 60 Sec., test voltage by type	By type
Temperature Coefficient	IEC 60115-1 4.8	-55°C to +155°C	By type
Insulation Resistance	IEC 60115-1 4.6	in V-block for 60 Sec.	>100MΩ
Solderability	IEC 60115-1 4.17	235±5°C for 3±0.5 Sec.	95% Min. coverage
Solvent Resistance of Marking	IEC 60115-1 4.30	IPA for 5±0.5 Min. with ultrasonic	No deterioration of coatings and markings
Robustness of Terminations	IEC 60115-1 4.16	Direct load for 10 Sec. in the direction of the terminal leads	≥2.5kg (24.5N)
Periodic-pulse Overload	IEC 60115-1 4.39	4 times RCWV 10,000 cycles (1 Sec. on, 25 Sec. off)	±1.0%+0.05Ω
Damp Heat Steady State	IEC 60115-1 4.24	40±2°C, 90-95% RH for 56 days, loaded with 0.1 times RCWV	±5.0%+0.05Ω
Endurance at 70°C	IEC 60115-1 4.25	70±2°C at RCWV for 1,000 Hr. (1.5 Hr. on, 0.5 Hr. off)	±5.0%+0.05Ω
Temperature Cycling	IEC 60115-1 4.19	-55°C ⇌ Room Temp. ⇌ +155°C ⇌ Room Temp. (5 cycles)	±2.0%+0.05Ω
Resistance to Soldering Heat	IEC 60115-1 4.18	260±3°C for 10±1 Sec., immersed to a point 3±0.5mm from the body	±1.0%+0.05Ω
Accidental Overload Test	IEC 60115-1 4.26	4 times RCWV for 1 Min.	No evidence of flaming or arcing

Note: RCWV(Rated Continuous Working Voltage) = $\sqrt{\text{Power Rating} \times \text{Resistance Value}}$ or Max. working voltage listed above, whichever less.

Revision: 201304

HID Lamp Resistors

HID Lamp Type

Metal Film Style [HTM Series]
Carbon Film Style [HTR Series]



INTRODUCTION

The HTM Series Metal Film Resistors are manufactured using a vacuum sputtering system to deposit multiple layers of mixed metal alloys onto a carefully treated high grade ceramic substrate. And the HTR Series Carbon Film Resistors are manufactured by coating a homogeneous film of pure carbon on high grade ceramic rods. After a helical groove has been cut in the resistive layer, steel copper plated wires are welded to the end-caps. The resistor is not coated. This is a special product for HID lamps, providing high power within a small package and saving space.

FEATURES

Power Rating	2W, 2.5W
Resistance Tolerance	±5%
T.C.R.	±250ppm/°C, -500~350ppm/°C

DIMENSIONS

Unit: mm

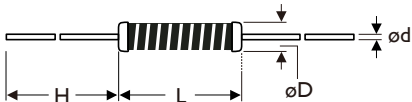

STYLE	DIMENSION			
	L	øD	H	ød
HTR200	8.5±0.3	3.5±0.2	26±2.0	0.8±0.05
HTM200	8.5±0.3	3.5±0.2	26±2.0	0.8±0.05
HTM250	15.5±0.3	3.5±0.2	33±2.0	0.8±0.05

Note:

ELECTRICAL CHARACTERISTICS

STYLE	HTR200	HTM200	HTM250
Power Rating at 70°C	2W		2.5W
Maximum Working Voltage	$\sqrt{P \times R}$		
Resistance Range	2KΩ - 100KΩ for E24 series value		
Temperature Coefficient	±250ppm/°C for HTM series, -500~+350ppm/°C for HTR series		

Note: Special value is available on request

ENVIRONMENTAL CHARACTERISTICS

PERFORMANCE TEST	TEST METHOD		APPRAISE
Short Time Overload	IEC 60115-1 4.13	2.5 times RCWV for 5 Sec.	±0.25% for HTM series ±0.50% for HTR series
Temperature Coefficient	IEC 60115-1 4.8	-55°C to +155°C	By type
Robustness of Terminations	IEC 60115-1 4.16	Direct load for 10 Sec. in the direction of the terminal leads	≥4kg (39.2N)
Periodic-pulse Overload	IEC 60115-1 4.39	4 times RCWV 10,000 cycles (1 Sec. on, 25 Sec. off)	±1.0%+0.05Ω
Endurance at 70°C	IEC 60115-1 4.25	70±2°C at RCWV for 1,000 Hr: (1.5 Hr. on, 0.5 Hr. off)	±1.5%+0.05Ω
Temperature Cycling	IEC 60115-1 4.19	-55°C ⇌ Room Temp. ⇌ +155°C ⇌ Room Temp. (5 cycles)	±0.75%+0.05Ω

Note: RCWV(Rated Continuous Working Voltage) = $\sqrt{\text{Power Rating} \times \text{Resistance Value}}$ or Max. working voltage listed above, whichever less.

Metal Oxide Film Resistors

Flame-Proof Type

Normal & Miniature Style [RSF Series]

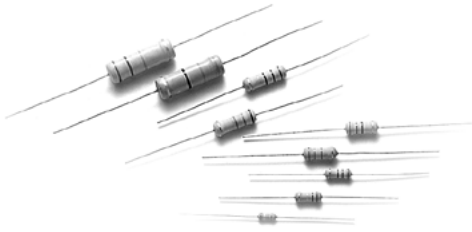

INTRODUCTION

The RSF Series Metal Oxide Film Flame-Proof Resistors offer excellent performance in applications where stability and uniformity of characteristics are desired. They provide lower cost alternatives to Carbon Composition Resistors and General Purpose Metal Films. Metal Oxides also can replace many low power General Purpose wirewound applications, saving both money and time, with shorter delivery cycles. The normal style & 'RSF-WV' style of RSF series are coated with layers of gray flame-proof lacquer, and the miniature style except 'RSF-WV' style are coated with layers of pink colors flame-proof lacquer.

DIMENSIONS

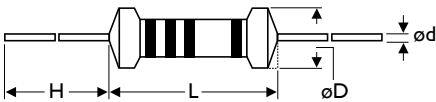

Note: RSF1WS (for MB Type) $\phi d = 0.8 \pm 0.05 \text{mm}$
RSF3WV, RSF4WV: Marking Printed

FEATURES

Power Rating	1/4W, 1/2W, 1W, 2W, 3W, 5W
Resistance Tolerance	$\pm 2\%$, $\pm 5\%$
T.C.R.	$\pm 300 \text{ppm}/^\circ\text{C}$
Flameproof Multi-layer Coating Meets	UL-94V-0
Flameproof Feature Meets Overload Test	UL-1412

DERATING CURVE

For resistors operated in ambient temperatures above 70°C , power rating must be derated in accordance with the curve below.

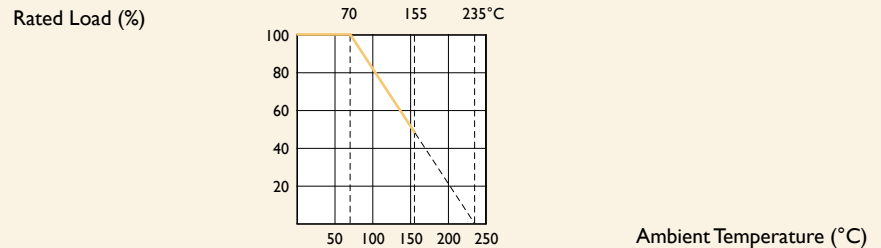

Unit: mm

STYLE		DIMENSION			
Normal	Miniature	L	ϕD	H	ϕd
RSF-25	RSF50S / RSF1WV	6.3 ± 0.5	2.4 ± 0.2	28 ± 2.0	0.55 ± 0.05
RSF-50	RSF1WS	9.0 ± 0.5	3.3 ± 0.3	26 ± 2.0	0.55 ± 0.05
RSF100	RSF2WS / RSF2WV	11.5 ± 1.0	4.5 ± 0.5	35 ± 2.0	0.8 ± 0.05
RSF200	RSF3WS	15.5 ± 1.0	5.0 ± 0.5	33 ± 2.0	0.8 ± 0.05
-	RSF3WV	$16.5 +0/-1.5$	$6.0 +0/-0.5$	33 ± 2.0	0.8 ± 0.05
RSF3WM	RSF5SS	17.5 ± 1.0	6.5 ± 1.0	32 ± 2.0	0.8 ± 0.05
-	RSF4WV	$20 +0/-1$	$9.0 +0/-0.5$	31 ± 2.0	0.8 ± 0.05
RSF300	RSF5WS	24.5 ± 1.0	8.5 ± 1.0	38 ± 2.0	0.8 ± 0.05
RSF500	-	24.5 ± 1.0	8.5 ± 1.0	38 ± 2.0	0.8 ± 0.05

ELECTRICAL CHARACTERISTICS

NORMAL STYLE

STYLE	RSF-25	RSF-50	RSF100	RSF200	RSF3WM	RSF300	RSF500
Power Rating at 70°C	1/4W	1/2W	1W	2W	3W		5W
Maximum Working Voltage	200V	250V	350V		450V	500V	750V
Maximum Overload Voltage	300V	400V	600V		700V	800V	1,000V
Voltage Proof on Insulation	250V	350V	500V				
Resistance Range	1Ω - 1MΩ & 0Ω for E24 series value						
Operating Temp. Range	-55°C to +235°C						
Temperature Coefficient	±300ppm/°C						

MINIATURE STYLE

STYLE	RSF50S	RSF1WV	RSF1WS	RSF2WS	RSF2WV	RSF3WS	RSF3WV	RSF5SS	RSF4WV	RSF5WS
Power Rating at 70°C	1/2W	1W		2W		3W		5W	4W	5W
Maximum Working Voltage	250V	500V	300V	350V	500V	350V	750V	500V	750V	700V
Maximum Overload Voltage	400V	500V		600V			750V	800V		900V
Voltage Proof on Insulation	350V	500V	400V	500V						
Resistance Range	1Ω - 1MΩ & 0Ω for E24 series value									
Operating Temp. Range	-55°C to +235°C									
Temperature Coefficient	±300ppm/°C									

Note: Special value is available on request

ENVIRONMENTAL CHARACTERISTICS

PERFORMANCE TEST	TEST METHOD		APPRAISE
Short Time Overload	IEC 60115-1 4.13	2.5 times RCWV for 5 Sec.	±1.0%+0.05Ω for normal style ±2.0%+0.05Ω for miniature style
Voltage Proof on Insulation	IEC 60115-1 4.7	in V-block for 60 Sec., test voltage by type	By type
Temperature Coefficient	IEC 60115-1 4.8	-55°C to +155°C	By type
Insulation Resistance	IEC 60115-1 4.6	in V-block for 60 Sec.	>1,000MΩ
Solderability	IEC 60115-1 4.17	235±5°C for 3±0.5 Sec.	95% Min. coverage
Solvent Resistance of Marking	IEC 60115-1 4.30	IPA for 5±0.5 Min. with ultrasonic	No deterioration of coatings and markings
Robustness of Terminations	IEC 60115-1 4.16	Direct load for 10 Sec. in the direction of the terminal leads	≥2.5kg (24.5N)
Periodic-pulse Overload	IEC 60115-1 4.39	4 times RCWV 10,000 cycles (1 Sec. on, 25 Sec. off)	±2.0%+0.05Ω
Damp Heat Steady State	IEC 60115-1 4.24	40±2°C, 90-95% RH for 56 days, loaded with 0.1 times RCWV	±5.0%+0.05Ω
Endurance at 70°C	IEC 60115-1 4.25	70±2°C at RCWV for 1,000 Hr. (1.5 Hr. on, 0.5 Hr. off)	±5.0%+0.05Ω
Temperature Cycling	IEC 60115-1 4.19	-55°C ⇄ Room Temp. ⇄ +155°C ⇄ Room Temp. (5 cycles)	±1.0%+0.05Ω
Resistance to Soldering Heat	IEC 60115-1 4.18	260±3°C for 10±1 Sec., immersed to a point 3±0.5mm from the body	±1.0%+0.05Ω
Accidental Overload Test	IEC 60115-1 4.26	4 times RCWV for 1 Min.	No evidence of flaming or arcing

Note: Rated Continuous Working Voltage (RCWV) = $\sqrt{\text{Power Rating} \times \text{Resistance Value}}$ or Max. working voltage listed above, whichever less.

Revision: 201304

Melf Metal Film Resistors

General Type

Normal & Miniature Style [MMF Series]



INTRODUCTION

The MMF Series Melf Metal Film Resistors are manufactured using a vacuum sputtering system to deposit multiple layers of mixed metal alloys and passivative materials onto a carefully treated high grade ceramic substrate. SMD enabled structure. The resistors are coated with layers of blue color lacquer.

FEATURES

Power Rating	1/6W, 1/4W, 0.4W, 1/2W, 0.6W, 1W
Resistance Tolerance	±0.1%, ±0.25%, ±0.5%, ±1%, ±2%, ±5%
T.C.R.	±15ppm/°C, ±25ppm/°C, ±50ppm/°C, ±100ppm/°C

DERATING CURVE

For resistors operated in ambient temperatures above 70°C, power rating must be derated in accordance with the curve below.

Rated Load (%)

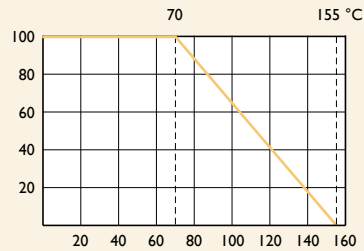

Ambient Temperature (°C)

DIMENSIONS

Unit: mm

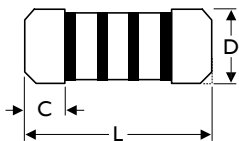

STYLE

DIMENSION

Normal	Miniature	L	D	C Min.
MMF-12	MMF25S / MMF204	3.50±0.2	1.40±0.15	0.5
MMF-25	MMF50S / MMF207	5.90±0.2	2.20±0.1	0.5
MMF-50	MMF1WS	8.50±0.2	3.20±0.2	0.5

Note:

ELECTRICAL CHARACTERISTICS

STYLE	MMF-12	MMF25S	MMF204	MMF-25	MMF50S	MMF207	MMF-50	MMFIWS
Power Rating at 70°C	1/6W	1/4W	0.4W	1/4W	1/2W	0.6W	1/2W	1W
Maximum Working Voltage	150V	200V		250V			350V	
Maximum Overload Voltage	300V	400V		500V			700V	
Voltage Proof on Insulation	300V			500V			700V	
Resistance Range	1Ω - 1MΩ & 0Ω for E24 & E96 series value, 100Ω - 100KΩ for E192 series value							
Operating Temp. Range	-55°C to +155°C							
Temperature Coefficient	±15ppm/°C, ±25ppm/°C, ±50ppm/°C, ±100ppm/°C							

Note: Special value is available on request

ENVIRONMENTAL CHARACTERISTICS

PERFORMANCE TEST	TEST METHOD	APPRAISE
Short Time Overload	IEC 60115-1 4.13 2.5 times RCWV for 5 Sec.	±0.5%+0.05Ω
Voltage Proof on Insulation	IEC 60115-1 4.7 in V-block for 60 Sec., test voltage by type	By type
Temperature Coefficient	IEC 60115-1 4.8 -55°C to +155°C	By type
Insulation Resistance	IEC 60115-1 4.6 in V-block for 60 Sec.	> 10,000MΩ
Solderability	IEC 60115-1 4.17 235±5°C for 3±0.5 Sec.	95% Min. coverage
Solvent Resistance of Marking	IEC 60115-1 4.30 IPA for 5±0.5 Min. with ultrasonic	No deterioration of coatings and markings
Periodic-pulse Overload	IEC 60115-1 4.39 4 times RCWV 10,000 cycles (1 Sec. on, 25 Sec. off)	±1.0%+0.05Ω
Damp Heat Steady State	IEC 60115-1 4.24 40±2°C, 90-95% RH for 56 days, loaded with 0.1 times RCWV	±2.0%+0.1Ω
Endurance at 70°C	IEC 60115-1 4.25 70±2°C at RCWV for 1,000 Hr. (1.5 Hr. on, 0.5 Hr. off)	±2.0%+0.1Ω
Temperature Cycling	IEC 60115-1 4.19 -55°C ⇄ Room Temp. ⇄ +155°C ⇄ Room Temp. (5 cycles)	±0.75%+0.05Ω
Resistance to Soldering Heat	IEC 60115-1 4.18 260±3°C for 10±1 Sec., immersed to a point 3±0.5mm from the body	±0.5%+0.05Ω

Note: RCWV(Rated Continuous Working Voltage) = √ Power Rating x Resistance Value or Max. working voltage listed above, whichever less.

Melf Metal Film Resistors

High Power Type

Ultra Miniature Style [MMP Series]



INTRODUCTION

The MMP Series Melf Metal Film High Power Resistors are manufactured using a vacuum sputtering system to deposit multiple layers of mixed metal alloys and passivative materials onto a carefully treated high grade ceramic substrate. SMD enabled structure and high power in small packages. The resistors are coated with layers of lacquer.

FEATURES

Power Rating	1W, 2W
Resistance Tolerance	±1%, ±2%, ±5%
T.C.R.	±50ppm/°C, ±100ppm/°C

DERATING CURVE

For resistors operated in ambient temperatures above 70°C, power rating must be derated in accordance with the curve below.

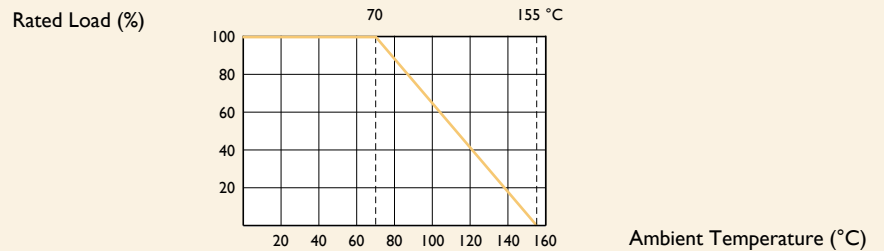

DIMENSIONS

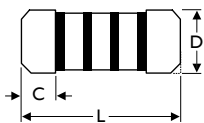

Unit: mm

STYLE	DIMENSION		
	L	D	C Min.
Ultra Miniature			
MMP100	5.9±0.2	2.2±0.1	0.5
MMP200	8.5±0.2	3.2±0.2	0.5

Note:

ELECTRICAL CHARACTERISTICS

STYLE	MMP100	MMP200
Power Rating at 70°C	1W	2W
Maximum Working Voltage	350V	
Maximum Overload Voltage	700V	
Voltage Proof on Insulation	500V	
Resistance Range	1Ω - 1MΩ & 0Ω for E24 & E96 series value	
Operating Temp. Range	-55°C to +155°C	
Temperature Coefficient	±50ppm/°C, ±100ppm/°C	

Note: Special value is available on request

ENVIRONMENTAL CHARACTERISTICS

PERFORMANCE TEST	TEST METHOD	APPRAISE
Short Time Overload	IEC 60115-1 4.13 2.5 times RCWV for 5 Sec.	±0.5%+0.05Ω
Voltage Proof on Insulation	IEC 60115-1 4.7 in V-block for 60 Sec., test voltage by type	By type
Temperature Coefficient	IEC 60115-1 4.8 -55°C to +155°C	By type
Insulation Resistance	IEC 60115-1 4.6 in V-block for 60 Sec.	>10,000MΩ
Solderability	IEC 60115-1 4.17 235±5°C for 3±0.5 Sec.	95% Min. coverage
Solvent Resistance of Marking	IEC 60115-1 4.30 IPA for 5±0.5 Min. with ultrasonic	No deterioration of coatings and markings
Periodic-pulse Overload	IEC 60115-1 4.39 4 times RCWV 10,000 cycles (1 Sec. on, 25 Sec. off)	±1.0%+0.05Ω
Damp Heat Steady State	IEC 60115-1 4.24 40±2°C, 90-95% RH for 56 days, loaded with 0.1 times RCWV	±2.0%+0.1Ω
Endurance at 70°C	IEC 60115-1 4.25 70±2°C at RCWV for 1,000 Hr: (1.5 Hr. on, 0.5 Hr. off)	±2.0%+0.1Ω
Temperature Cycling	IEC 60115-1 4.19 -55°C ⇄ Room Temp. ⇄ +155°C ⇄ Room Temp. (5 cycles)	±0.75%+0.05Ω
Resistance to Soldering Heat	IEC 60115-1 4.18 260±3°C for 10±1 Sec., immersed to a point 3±0.5mm from the body	±0.5%+0.05Ω

Note: RCWV(Rated Continuous Working Voltage) = $\sqrt{\text{Power Rating} \times \text{Resistance Value}}$ or Max. working voltage listed above, whichever less.

Carbon Film Resistors

General Type

Normal & Miniature Style [CFR Series]

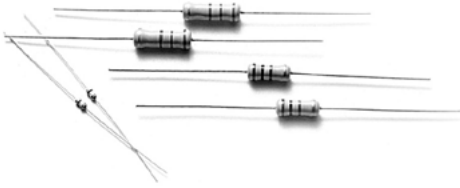

INTRODUCTION

The CFR Series Carbon Film Resistors are manufactured by coating a homogeneous film of pure carbon on high grade ceramic rods. After a helical groove has been cut in the resistive layer, tinned connecting leads of electrolytic copper are welded to the end-caps. The resistors are coated with layers of tan color lacquer.

FEATURES

Power Rating	1/6W, 1/4W, 1/2W, 1W, 2W, 3W
Resistance Tolerance	±2%, ±5%
T.C.R.	see Table I

DERATING CURVE

For resistors operated in ambient temperatures above 70°C, power rating must be derated in accordance with the curve below.

Rated Load (%)

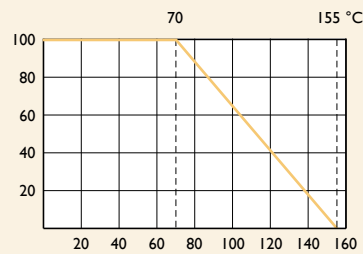

Ambient Temperature (°C)

TABLE I TEMPERATURE COEFFICIENT

STYLE	TEMP. COEFFICIENT (ppm/°C)		
	under 100KΩ	100KΩ - 1MΩ	1MΩ - 10MΩ
CFR100, CFR200, CFR2WS, CFR3WS	-350~350	-500~0	-1,500~0
CFR-12, CFR-25, CFR-50, CFR25S, CFR50S, CFR1WS	-350~500	-700~0	-1,500~0

DIMENSIONS

Unit: mm

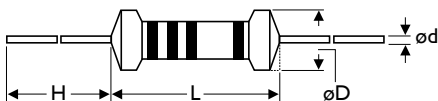

STYLE		DIMENSION			
Normal	Miniature	L	øD	H	ød
CFR-12	CFR25S	3.4±0.3	1.9±0.2	28±2.0	0.45±0.05
CFR-25	CFR50S	6.3±0.5	2.4±0.2	28±2.0	0.55±0.05
CFR-50	CFR1WS	9.0±0.5	3.3±0.3	26±2.0	0.55±0.05
CFR100	CFR2WS	11.5±1.0	4.5±0.5	35±2.0	0.8±0.05
CFR200	CFR3WS	15.5±1.0	5.0±0.5	33±2.0	0.8±0.05

Note:

ELECTRICAL CHARACTERISTICS

STYLE	CFR-12	CFR25S	CFR-25	CFR50S	CFR-50	CFRIWS	CFRI00	CFR2WS	CFR200	CFR3WS
Power Rating at 70°C	1/6W	1/4W		1/2W		1W		2W		3W
Maximum Working Voltage	150V	200V	250V	300V	350V	400V	500V			
Maximum Overload Voltage	300V	400V	500V	600V	700V	800V	1,000V			
Voltage Proof on Insulation	300V	400V	500V			700V	1,000V			
Resistance Range	1Ω - 10MΩ & 0Ω for E24 series value									
Operating Temp. Range	-55°C to +155°C									
Temperature Coefficient	see Table I									

Note: Special value is available on request

ENVIRONMENTAL CHARACTERISTICS

PERFORMANCE TEST	TEST METHOD		APPRAISE
Short Time Overload	IEC 60115-1 4.13	2.5 times RCWV for 5 Sec.	±0.75%+0.05Ω
Voltage Proof on Insulation	IEC 60115-1 4.7	in V-block for 60 Sec., test voltage by type	By type
Temperature Coefficient	IEC 60115-1 4.8	-55°C to +155°C	By type
Insulation Resistance	IEC 60115-1 4.6	in V-block for 60 Sec.	>1,000MΩ
Solderability	IEC 60115-1 4.17	235±5°C for 3±0.5 Sec.	95% Min. coverage
Solvent Resistance of Marking	IEC 60115-1 4.30	IPA for 5±0.5 Min. with ultrasonic	No deterioration of coatings and markings
Robustness of Terminations	IEC 60115-1 4.16	Direct load for 10 Sec. in the direction of the terminal leads	≥2.5kg (24.5N)
Periodic-pulse Overload	IEC 60115-1 4.39	4 times RCWV 10,000 cycles (1 Sec. on, 25 Sec. off)	±1.0%+0.05Ω
Damp Heat Steady State	IEC 60115-1 4.24	40±2°C, 90-95% RH for 56 days, loaded with 0.1 times RCWV	±3.0%+0.05Ω
Endurance at 70°C	IEC 60115-1 4.25	70±2°C at RCWV for 1,000 Hr: (1.5 Hr. on, 0.5 Hr. off)	±3.0%+0.05Ω
Temperature Cycling	IEC 60115-1 4.19	-55°C ⇌ Room Temp. ⇌ +155°C ⇌ Room Temp. (5 cycles)	±1.0%+0.05Ω
Resistance to Soldering Heat	IEC 60115-1 4.18	260±3°C for 10±1 Sec., immersed to a point 3±0.5mm from the body	±1.0%+0.05Ω

Note: RCWV(Rated Continuous Working Voltage) = $\sqrt{\text{Power Rating} \times \text{Resistance Value}}$ or Max. working voltage listed above, whichever less.

Carbon Film Resistors

Professional Type

Miniature Style [CF0 Series]



INTRODUCTION

The CF0 Series Carbon Film Professional Resistors are manufactured by coating a homogeneous film of pure carbon on high grade ceramic rods. After a helical groove has been cut in the resistive layer, tinned connecting leads of electrolytic copper are welded to the end-caps. The resistors are coated with layers of tan color lacquer.

FEATURES

Power Rating	0.4W, 0.6W
Resistance Tolerance	±2%, ±5%
T.C.R.	see Table I

DERATING CURVE

For resistors operated in ambient temperatures above 70°C, power rating must be derated in accordance with the curve below.

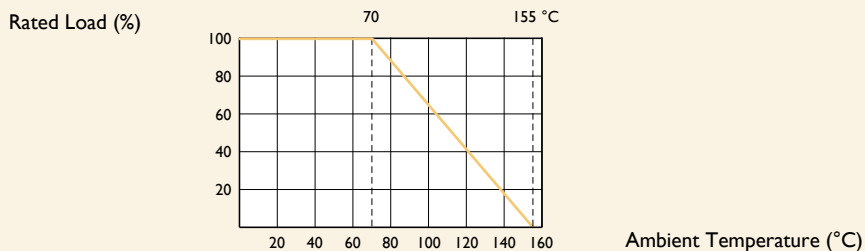
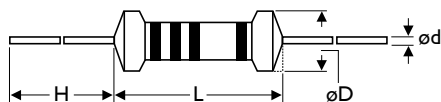

TABLE I TEMPERATURE COEFFICIENT

STYLE	TEMP. COEFFICIENT (ppm/°C)		
	under 100KΩ	100KΩ - 1MΩ	1MΩ - 10MΩ
CF0204, CF0207	-500~350	-700~0	-1,500~0

DIMENSIONS



Unit: mm

STYLE	DIMENSION			
	L	øD	H	ød
CF0204	3.4±0.3	1.9±0.2	28±2.0	0.45±0.05
CF0207	6.3±0.5	2.4±0.2	28±2.0	0.55±0.05

Note:

ELECTRICAL CHARACTERISTICS

STYLE	CF0204	CF0207
Power Rating at 70°C	0.4W	0.6W
Maximum Working Voltage	200V	300V
Maximum Overload Voltage	400V	600V
Voltage Proof on Insulation	300V	500V
Resistance Range	1Ω - 10MΩ & 0Ω for E24 series value	
Operating Temp. Range	-55°C to +155°C	
Temperature Coefficient	see Table I	

Note: Special value is available on request

ENVIRONMENTAL CHARACTERISTICS

PERFORMANCE TEST	TEST METHOD		APPRAISE
Short Time Overload	IEC 60115-1 4.13	2.5 times RCWV for 5 Sec.	±0.75%+0.05Ω
Voltage Proof on Insulation	IEC 60115-1 4.7	in V-block for 60 Sec., test voltage by type	By type
Temperature Coefficient	IEC 60115-1 4.8	-55°C to +155°C	By type
Insulation Resistance	IEC 60115-1 4.6	in V-block for 60 Sec.	>1,000MΩ
Solderability	IEC 60115-1 4.17	235±5°C for 3±0.5 Sec.	95% Min. coverage
Solvent Resistance of Marking	IEC 60115-1 4.30	IPA for 5±0.5 Min. with ultrasonic	No deterioration of coatings and markings
Robustness of Terminations	IEC 60115-1 4.16	Direct load for 10 Sec. in the direction of the terminal leads	≥2.5kg (24.5N)
Periodic-pulse Overload	IEC 60115-1 4.39	4 times RCWV 10,000 cycles (1 Sec. on, 25 Sec. off)	±1.0%+0.05Ω
Damp Heat Steady State	IEC 60115-1 4.24	40±2°C, 90-95% RH for 56 days, loaded with 0.1 times RCWV	±3.0%+0.05Ω
Endurance at 70°C	IEC 60115-1 4.25	70±2°C at RCWV for 1,000 Hr. (1.5 Hr. on, 0.5 Hr. off)	±3.0%+0.05Ω
Temperature Cycling	IEC 60115-1 4.19	-55°C ⇄ Room Temp. ⇄ +155°C ⇄ Room Temp. (5 cycles)	±1.0%+0.05Ω
Resistance to Soldering Heat	IEC 60115-1 4.18	260±3°C for 10±1 Sec., immersed to a point 3±0.5mm from the body	±1.0%+0.05Ω

Note: RCWV(Rated Continuous Working Voltage) = $\sqrt{\text{Power Rating} \times \text{Resistance Value}}$ or Max. working voltage listed above, whichever less.

Carbon Film Resistors

Flame-Proof Type

Normal & Miniature Style [FCR Series]

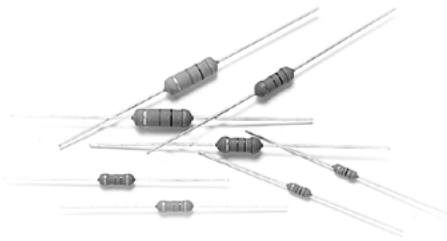

INTRODUCTION

The FCR Series Carbon Film Flame-Proof Resistors are manufactured by coating a homogeneous film of pure carbon on high grade ceramic rods. After a helical groove has been cut in the resistive layer, tinned connecting leads of electrolytic copper are welded to the end-caps. The resistors are coated with layers of gray color lacquer.

FEATURES

Power Rating	1/4W, 1/2W, 1W, 2W, 3W
Resistance Tolerance	±2%, ±5%
T.C.R.	see Table I
Flameproof Multi-layer Coating Meets	UL-94V-0
Flameproof Feature Meets Overload Test	UL-1412

DERATING CURVE

For resistors operated in ambient temperatures above 70°C, power rating must be derated in accordance with the curve below.

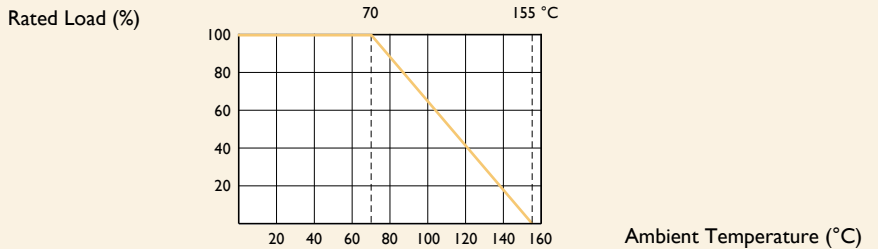
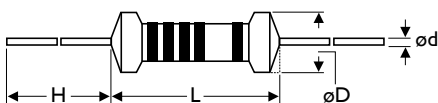

TABLE I TEMPERATURE COEFFICIENT

STYLE	TEMP. COEFFICIENT (ppm/°C)		
	under 100KΩ	100KΩ - 1MΩ	1MΩ - 10MΩ
FCR100, FCR200, FCR2WS, FCR3WS	-350~350	-500~0	-1,500~0
FCR-25, FCR-50, FCR50S, FCR1WS	-500~350	-700~0	-1,500~0

DIMENSIONS



5th color code: black

Unit: mm

STYLE		DIMENSION			
Normal	Miniature	L	øD	H	ød
FCR-25	FCR50S	6.3±0.5	2.4±0.2	28±2.0	0.55±0.05
FCR-50	FCR1WS	9.0±0.5	3.3±0.3	26±2.0	0.55±0.05
FCR100	FCR2WS	11.5±1.0	4.5±0.5	35±2.0	0.8±0.05
FCR200	FCR3WS	15.5±1.0	5.0±0.5	33±2.0	0.8±0.05

Note:

ELECTRICAL CHARACTERISTICS

STYLE	FCR-25	FCR50S	FCR-50	FCRIWS	FCRI00	FCR2WS	FCR200	FCR3WS
Power Rating at 70°C	1/4W	1/2W		1W		2W		3W
Maximum Working Voltage	250V	300V	350V	400V	500V			
Maximum Overload Voltage	500V	600V	700V	800V	1,000V			
Voltage Proof on Insulation	400V		500V					
Resistance Range	1Ω - 10MΩ & 0Ω for E24 series value							
Operating Temp. Range	-55°C to +155°C							
Temperature Coefficient	see Table I							

Note: Special value is available on request

ENVIRONMENTAL CHARACTERISTICS

PERFORMANCE TEST	TEST METHOD	APPRAISE
Short Time Overload	IEC 60115-1 4.13 2.5 times RCWV for 5 Sec.	±0.75%+0.05Ω
Voltage Proof on Insulation	IEC 60115-1 4.7 in V-block for 60 Sec., test voltage by type	By type
Temperature Coefficient	IEC 60115-1 4.8 -55°C to +155°C	By type
Insulation Resistance	IEC 60115-1 4.6 in V-block for 60 Sec.	>1,000MΩ
Solderability	IEC 60115-1 4.17 235±5°C for 3±0.5 Sec.	95% Min. coverage
Solvent Resistance of Marking	IEC 60115-1 4.30 IPA for 5±0.5 Min. with ultrasonic	No deterioration of coatings and markings
Robustness of Terminations	IEC 60115-1 4.16 Direct load for 10 Sec. in the direction of the terminal leads	≥2.5kg (24.5N)
Periodic-pulse Overload	IEC 60115-1 4.39 4 times RCWV 10,000 cycles (1 Sec. on, 25 Sec. off)	±1.0%+0.05Ω
Damp Heat Steady State	IEC 60115-1 4.24 40±2°C, 90-95% RH for 56 days, loaded with 0.1 times RCWV	±3.0%+0.05Ω
Endurance at 70°C	IEC 60115-1 4.25 70±2°C at RCWV for 1,000 Hr. (1.5 Hr. on, 0.5 Hr. off)	±3.0%+0.05Ω
Temperature Cycling	IEC 60115-1 4.19 -55°C ⇌ Room Temp. ⇌ +155°C ⇌ Room Temp. (5 cycles)	±1.0%+0.05Ω
Resistance to Soldering Heat	IEC 60115-1 4.18 260±3°C for 10±1 Sec., immersed to a point 3±0.5mm from the body	±1.0%+0.05Ω
Accidental Overload Test	IEC 60115-1 4.26 4 times RCWV for 1 Min.	No evidence of flaming or arcing

Note: RCWV(Rated Continuous Working Voltage) = $\sqrt{\text{Power Rating} \times \text{Resistance Value}}$ or Max. working voltage listed above, whichever less.

Carbon Film Resistors

Professional & Flame-Proof Type

Miniature Style [FC0 Series]

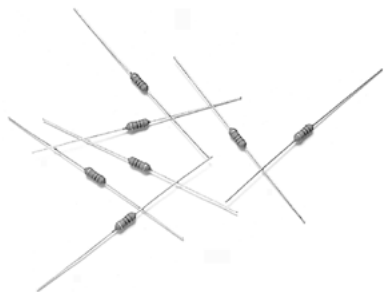

INTRODUCTION

The FC0 Series Carbon Film Professional & Flame-Proof Resistors are manufactured by coating a homogeneous film of pure carbon on high grade ceramic rods. After a helical groove has been cut in the resistive layer; tinned connecting leads of electrolytic copper are welded to the end-caps. The resistors are coated with layers of green color lacquer.

FEATURES

Power Rating	0.4W, 0.6W
Resistance Tolerance	±2%, ±5%
T.C.R.	see Table I
Flameproof Multi-layer Coating Meets	UL-94V-0
Flameproof Feature Meets Overload Test	UL-1412

DERATING CURVE

For resistors operated in ambient temperatures above 70°C, power rating must be derated in accordance with the curve below.

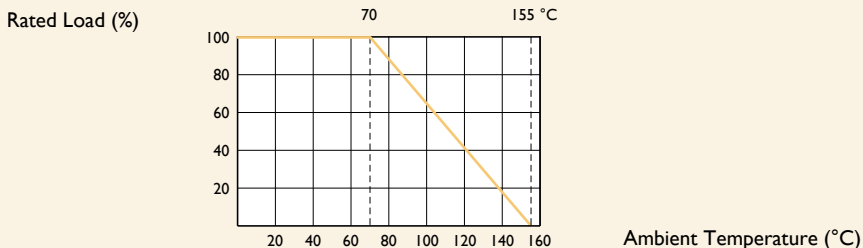
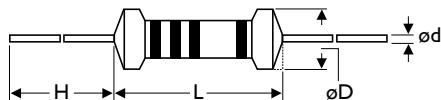

TABLE I TEMPERATURE COEFFICIENT

STYLE	TEMP. COEFFICIENT (ppm/°C)		
	under 100KΩ	100KΩ - 1MΩ	1MΩ - 10MΩ
FC0204, FC0207	-500~300	-700~0	-1,500~0

DIMENSIONS



Unit: mm

STYLE	DIMENSION			
	L	øD	H	ød
Miniature				
FC0204	3.4±0.3	1.9±0.2	28±2.0	0.45±0.05
FC0207	6.3±0.5	2.4±0.2	28±2.0	0.55±0.05

Note:

ELECTRICAL CHARACTERISTICS

STYLE	FC0204	FC0207
Power Rating at 70°C	0.4W	0.6W
Maximum Working Voltage	200V	300V
Maximum Overload Voltage	400V	600V
Voltage Proof on Insulation	300V	500V
Resistance Range	1Ω - 10MΩ & 0Ω for E24 series value	
Operating Temp. Range	-55°C to +155°C	
Temperature Coefficient	see Table I	

Note: Special value is available on request

ENVIRONMENTAL CHARACTERISTICS

PERFORMANCE TEST	TEST METHOD	APPRAISE
Short Time Overload	IEC 60115-1 4.13 2.5 times RCWV for 5 Sec.	±0.75%+0.05Ω
Voltage Proof on Insulation	IEC 60115-1 4.7 in V-block for 60 Sec., test voltage by type	By type
Temperature Coefficient	IEC 60115-1 4.8 -55°C to +155°C	By type
Insulation Resistance	IEC 60115-1 4.6 in V-block for 60 Sec.	>1,000MΩ
Solderability	IEC 60115-1 4.17 235±5°C for 3±0.5 Sec.	95% Min. coverage
Solvent Resistance of Marking	IEC 60115-1 4.30 IPA for 5±0.5 Min. with ultrasonic	No deterioration of coatings and markings
Robustness of Terminations	IEC 60115-1 4.16 Direct load for 10 Sec. in the direction of the terminal leads	≥2.5kg (24.5N)
Periodic-pulse Overload	IEC 60115-1 4.39 4 times RCWV 10,000 cycles (1 Sec. on, 25 Sec. off)	±1.0%+0.05Ω
Damp Heat Steady State	IEC 60115-1 4.24 40±2°C, 90-95% RH for 56 days, loaded with 0.1 times RCWV	±3.0%+0.05Ω
Endurance at 70°C	IEC 60115-1 4.25 70±2°C at RCWV for 1,000 Hr. (1.5 Hr. on, 0.5 Hr. off)	±3.0%+0.05Ω
Temperature Cycling	IEC 60115-1 4.19 -55°C ⇌ Room Temp. ⇌ +155°C ⇌ Room Temp. (5 cycles)	±1.0%+0.05Ω
Resistance to Soldering Heat	IEC 60115-1 4.18 260±3°C for 10±1 Sec., immersed to a point 3±0.5mm from the body	±1.0%+0.05Ω
Accidental Overload Test	IEC 60115-1 4.26 4 times RCWV for 1 Min.	No evidence of flaming or arcing

Note: RCWV(Rated Continuous Working Voltage) = $\sqrt{\text{Power Rating} \times \text{Resistance Value}}$ or Max. working voltage listed above, whichever less.

Carbon Film Resistors

Non-Inductive & Flame-Proof Type

Normal & Miniature Style [NCR Series]



INTRODUCTION

The NCR Series Carbon Film Non-Inductive & Flame-Proof Resistors are manufactured by coating a homogeneous film of pure carbon on high grade ceramic rods. Tinned connecting leads of electrolytic copper are welded to the end-caps. The inductance is $< 1 \mu\text{H}$.

The resistors are coated with layers of gray color lacquer for normal size & pink color lacquer for miniature size.

FEATURES

Power Rating	1/4W, 1/2W, 1W, 2W, 3W
Resistance Tolerance	$\pm 5\%$, $\pm 10\%$
T.C.R.	see Table I
Flameproof Multi-layer Coating Meets	UL-94V-0
Flameproof Feature Meets Overload Test	UL-1412

DERATING CURVE

For resistors operated in ambient temperatures above 70°C , power rating must be derated in accordance with the curve below.

Rated Load (%)

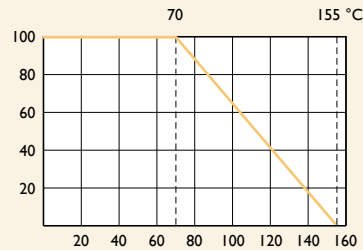

Ambient Temperature ($^\circ\text{C}$)

TABLE I TEMPERATURE COEFFICIENT

VALUE RANGE	TEMP. COEFFICIENT (ppm/ $^\circ\text{C}$)
Under $5\text{K}\Omega$	-500~0
$5\text{K} - 10\text{K}\Omega$	-800~0

DIMENSIONS

Unit: mm

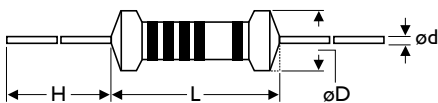

5th color code: green

STYLE		DIMENSION			
Normal	Miniature	L	ϕD	H	ϕd
NCR-25	NCR50S	6.3 ± 0.5	2.4 ± 0.2	28 ± 2.0	0.55 ± 0.05
NCR-50	NCR1WS	9.0 ± 0.5	3.3 ± 0.3	26 ± 2.0	0.55 ± 0.05
NCR100	NCR2WS	11.5 ± 1.0	4.5 ± 0.5	35 ± 2.0	0.8 ± 0.05
NCR200	NCR3WS	15.5 ± 1.0	5.0 ± 0.5	33 ± 2.0	0.8 ± 0.05

Note:

ELECTRICAL CHARACTERISTICS

STYLE	NCR-25	NCR50S	NCR-50	NCRIWS	NCR100	NCR2WS	NCR200	NCR3WS
Power Rating at 70°C	1/4W	1/2W		1W		2W		3W
Maximum Working Voltage	$\sqrt{P \times R}$							
Voltage Proof on Insulation	500V							
Resistance Range	2.2Ω - 10KΩ for E24 series value							
Operating Temp. Range	-55°C to +155°C							
Temperature Coefficient	see Table 1							

Note: Special value is available on request

ENVIRONMENTAL CHARACTERISTICS

PERFORMANCE TEST	TEST METHOD	APPRAISE
Short Time Overload	IEC 60115-1 4.13 2.5 times RCWV for 5 Sec.	±0.75%+0.05Ω for normal style ±2.0%+0.05Ω for miniature style
Voltage Proof on Insulation	IEC 60115-1 4.7 in V-block for 60 Sec., test voltage by type	By type
Temperature Coefficient	IEC 60115-1 4.8 -55°C to +155°C	By type
Insulation Resistance	IEC 60115-1 4.6 in V-block for 60 Sec.	>1,000MΩ
Solderability	IEC 60115-1 4.17 235±5°C for 3±0.5 Sec.	95% Min. coverage
Solvent Resistance of Marking	IEC 60115-1 4.30 IPA for 5±0.5 Min. with ultrasonic	No deterioration of coatings and markings
Robustness of Terminations	IEC 60115-1 4.16 Direct load for 10 Sec. in the direction of the terminal leads	≥2.5kg (24.5N)
Periodic-pulse Overload	IEC 60115-1 4.39 4 times RCWV 10,000 cycles (1 Sec. on, 25 Sec. off)	±1.0%+0.05Ω
Damp Heat Steady State	IEC 60115-1 4.24 40±2°C, 90-95% RH for 56 days, loaded with 0.1 times RCWV	±3.0%+0.05Ω
Endurance at 70°C	IEC 60115-1 4.25 70±2°C at RCWV for 1,000 Hr. (1.5 Hr. on, 0.5 Hr. off)	±3.0%+0.05Ω
Temperature Cycling	IEC 60115-1 4.19 -55°C ⇌ Room Temp. ⇌ +155°C ⇌ Room Temp. (5 cycles)	±1.0%+0.05Ω
Resistance to Soldering Heat	IEC 60115-1 4.18 260±3°C for 10±1 Sec., immersed to a point 3±0.5mm from the body	±1.0%+0.05Ω
Accidental Overload Test	IEC 60115-1 4.26 4 times RCWV for 1 Min.	No evidence of flaming or arcing

Note: RCWV(Rated Continuous Working Voltage) = $\sqrt{\text{Power Rating} \times \text{Resistance Value}}$ or Max. working voltage listed above, whichever less.

Melf Carbon Film Resistors

General Type

Normal & Miniature Style [MCF Series]



INTRODUCTION

The MCF Series Melf Carbon Film Resistors are manufactured by coating a homogeneous film of pure carbon on high grade ceramic rods. SMD enabled structure. The resistors are coated with layers of lacquer.

FEATURES

Power Rating	1/6W, 1/4W, 0.4W, 1/2W, 0.6W, 1W
Resistance Tolerance	±2%, ±5%
T.C.R.	see Table I

DERATING CURVE

For resistors operated in ambient temperatures above 70°C, power rating must be derated in accordance with the curve below.

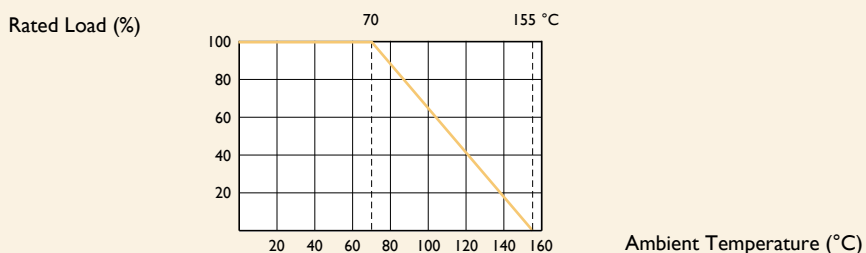
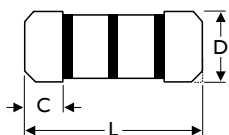

TABLE I TEMPERATURE COEFFICIENT

STYLE	MAX. VALUE OF TEMP. COEFFICIENT PPM/°C			
	under 1KΩ	1K1Ω -47KΩ	51KΩ -470KΩ	510KΩ -1MΩ
MCF-12, MCF25S, MCF204	0 to -350	0 to -600	0 to -1,000	0 to -1,500
MCF-25, MCF50S, MCF207, MCF-50, MCF1WS	0 to -350	0 to -600	0 to -1,000	

DIMENSIONS

Unit: mm



STYLE	DIMENSION	DIMENSION		
		Normal	Miniature	
		L	D	C Min.
MCF-12	MCF25S / MCF204	3.5±0.2	1.4±0.15	0.5
MCF-25	MCF50S / MCF207	5.9±0.2	2.2±0.1	0.5
MCF-50	MCF1WS	8.5±0.2	3.2±0.2	0.5

Note:

ELECTRICAL CHARACTERISTICS

STYLE	MCF-12	MCF25S	MCF204	MCF-25	MCF50S	MCF207	MCF-50	MCFIWS
Power Rating at 70°C	1/6W	1/4W	0.4W	1/4W	1/2W	0.6W	1/2W	1W
Maximum Working Voltage	200V	250V		300V			350V	
Maximum Overload Voltage	400V	500V		600V			700V	
Voltage Proof on Insulation	200V			500V			700V	
Resistance Range	10Ω - 1MΩ & 0Ω for E24 series value							
Operating Temp. Range	-55°C to +155°C							
Temperature Coefficient	see Table I							

Note: Special value is available on request

ENVIRONMENTAL CHARACTERISTICS

PERFORMANCE TEST	TEST METHOD		APPRAISE
Short Time Overload	IEC 60115-1 4.13	2.5 times RCWV for 5 Sec.	±1.0%+0.05Ω
Voltage Proof on Insulation	IEC 60115-1 4.7	in V-block for 60 Sec., test voltage by type	By type
Temperature Coefficient	IEC 60115-1 4.8	-55°C to +155°C	By type
Insulation Resistance	IEC 60115-1 4.6	in V-block for 60 Sec.	>10,000MΩ
Solderability	IEC 60115-1 4.17	235±5°C for 3±0.5 Sec.	95% Min. coverage
Solvent Resistance of Marking	IEC 60115-1 4.30	IPA for 5±0.5 Min. with ultrasonic	No deterioration of coatings and markings
Periodic-pulse Overload	IEC 60115-1 4.39	4 times RCWV 10,000 cycles (1 Sec. on, 25 Sec. off)	±1.0%+0.05Ω
Damp Heat Steady State	IEC 60115-1 4.24	40±2°C, 90-95% RH for 56 days, loaded with 0.1 times RCWV	±5.0%+0.1Ω
Endurance at 70°C	IEC 60115-1 4.25	70±2°C at RCWV for 1,000 Hr. (1.5 Hr. on, 0.5 Hr. off)	±3.0%+0.1Ω
Temperature Cycling	IEC 60115-1 4.19	-55°C ⇄ Room Temp. ⇄ +155°C ⇄ Room Temp. (5 cycles)	±0.75%+0.05Ω
Resistance to Soldering Heat	IEC 60115-1 4.18	260±3°C for 10±1 Sec., immersed to a point 3±0.5mm from the body	±1.0%+0.05Ω

Note: RCWV(Rated Continuous Working Voltage) = $\sqrt{\text{Power Rating} \times \text{Resistance Value}}$ or Max. working voltage listed above, whichever less.

Melf Carbon Film Resistors

High Power Type

Ultra Miniature Style [MCP Series]



INTRODUCTION

The MCP Series Melf Carbon Film High Power Resistors are manufactured by coating a homogeneous film of pure carbon on high grade ceramic rods. SMD enabled structure and high power in small packages. The resistors are coated with layers of lacquer.

FEATURES

Power Rating	1W, 2W
Resistance Tolerance	±2%, ±5%
T.C.R.	see Table I

DERATING CURVE

For resistors operated in ambient temperatures above 70°C, power rating must be derated in accordance with the curve below.

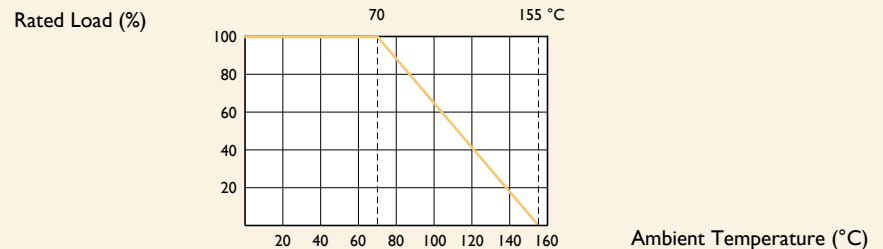
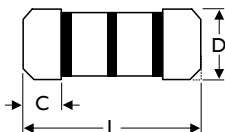

TABLE I TEMPERATURE COEFFICIENT

STYLE	TEMP. COEFFICIENT ppm/°C		
	under 10KΩ	11KΩ -150KΩ	160KΩ -1MΩ
MCP100, MCP200	-350~0	-600~0	-1,000~0

DIMENSIONS

Unit: mm



STYLE	DIMENSION		
	L	D	C Min.
MCP100	5.9±0.2	2.2±0.1	0.5
MCP200	8.5±1.0	3.0±0.2	0.5

Note:

ELECTRICAL CHARACTERISTICS

STYLE	MCP100	MCP200
Power Rating at 70°C	1W	2W
Maximum Working Voltage	300V	350V
Maximum Overload Voltage	600V	700V
Voltage Proof on Insulation	500V	
Resistance Range	1Ω - 1MΩ & 0Ω for E24 & E96 series value	
Operating Temp. Range	-55°C to +155°C	
Temperature Coefficient	See Table I	

Note: Special value is available on request

ENVIRONMENTAL CHARACTERISTICS

PERFORMANCE TEST	TEST METHOD	APPRAISE
Short Time Overload	IEC 60115-1 4.13 2.5 times RCWV for 5 Sec.	±1.0%+0.05Ω
Voltage Proof on Insulation	IEC 60115-1 4.7 in V-block for 60 Sec., test voltage by type	By type
Temperature Coefficient	IEC 60115-1 4.8 -55°C to +155°C	By type
Insulation Resistance	IEC 60115-1 4.6 in V-block for 60 Sec.	>10,000MΩ
Solderability	IEC 60115-1 4.17 235±5°C for 3±0.5 Sec.	95% Min. coverage
Solvent Resistance of Marking	IEC 60115-1 4.30 IPA for 5±0.5 Min. with ultrasonic	No deterioration of coatings and markings
Periodic-pulse Overload	IEC 60115-1 4.39 4 times RCWV 10,000 cycles (1 Sec. on, 25 Sec. off)	±1.0%+0.05Ω
Damp Heat Steady State	IEC 60115-1 4.24 40±2°C, 90-95% RH for 56 days, loaded with 0.1 times RCWV	±5.0%+0.1Ω
Endurance at 70°C	IEC 60115-1 4.25 70±2°C at RCWV for 1,000 Hr. (1.5 Hr. on, 0.5 Hr. off)	±3.0%+0.1Ω
Temperature Cycling	IEC 60115-1 4.19 -55°C ⇄ Room Temp. ⇄ +155°C ⇄ Room Temp. (5 cycles)	±0.75%+0.05Ω
Resistance to Soldering Heat	IEC 60115-1 4.18 260±3°C for 10±1 Sec., immersed to a point 3±0.5mm from the body	±1.0%+0.05Ω

Note: RCWV(Rated Continuous Working Voltage) = $\sqrt{\text{Power Rating} \times \text{Resistance Value}}$ or Max. working voltage listed above, whichever less.

Metal Glazed Film Resistors

High Voltage & High Ohmic Type

Normal & Miniature Style [HHV Series]

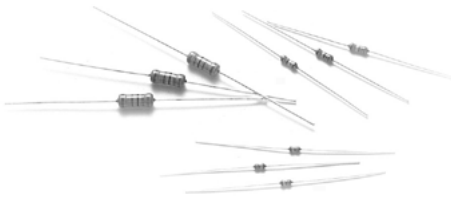

INTRODUCTION

The HHV Series High Voltage & High Ohmic Resistors are made of metal glaze film, with tinned connecting leads of electrolytic copper welded to the end-caps. The resistors are coated with layers of pink color lacquer.

FEATURES

Power Rating	1/4W, 1/2W, 1W, 2W, 3W
Resistance Tolerance	±1%, ±5%
T.C.R.	±200ppm/°C
Flameproof Multi-layer Coating Meets	UL-94V-0
Flameproof Feature Meets Overload Test	UL-1412

DERATING CURVE

For resistors operated in ambient temperatures above 70°C, power rating must be derated in accordance with the curve below.

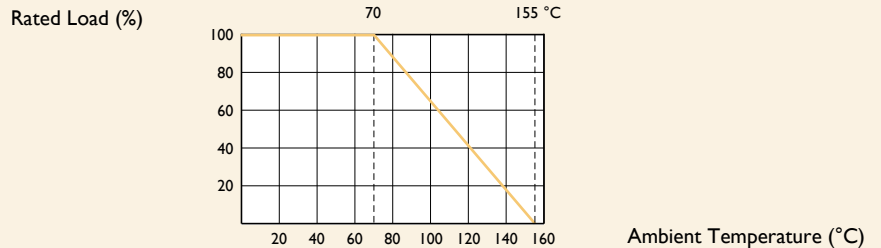

DIMENSIONS

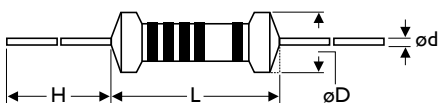

5th color code: yellow

Unit: mm

STYLE		DIMENSION			
Normal	Miniature	L	øD	H	ød
HHV-25	HHV50S	6.3±0.5	2.4±0.2	28±2.0	0.55±0.05
HHV-50	HHV1SS	9.0±0.5	3.3±0.3	26±2.0	0.55±0.05
HHV1WS	HHV2SS	11.5±1.0	4.5±0.5	35±2.0	0.8±0.05
HHV2WS	HHV3SS	15.5±1.0	5.0±0.5	33±2.0	0.8±0.05

Note:

ELECTRICAL CHARACTERISTICS

STYLE	HHV-25	HHV50S	HHV-50	HHVISS	HHVIWS	HHV2SS	HHV2WS	HHV3SS
Power Rating at 70°C	1/4W	1/2W		1W		2W		3W
Maximum Working Voltage (DC)	1,600V		3,500V		5,000V		7,000V	
Maximum Overload Voltage (DC)	3,000V		7,000V		10,000V		14,000V	
Voltage Proof on Insulation	300V		500V		700V			
Resistance Range	100KΩ - 68MΩ for E24 & E96 series value							
Operating Temp. Range	-55°C to +155°C							
Temperature Coefficient	±200pm/°C							

Note: Special value is available on request

ENVIRONMENTAL CHARACTERISTICS

PERFORMANCE TEST	TEST METHOD	APPRAISE
Short Time Overload	IEC 60115-1 4.13 2.5 times RCWV for 5 Sec.	±2.0%+0.05Ω
Voltage Proof on Insulation	IEC 60115-1 4.7 in V-block for 60 Sec., test voltage by type	By type
Temperature Coefficient	IEC 60115-1 4.8 -55°C to +155°C	By type
Insulation Resistance	IEC 60115-1 4.6 in V-block for 60 Sec.	>10,000MΩ
Solderability	IEC 60115-1 4.17 235±5°C for 3±0.5 Sec.	95% Min. coverage
Solvent Resistance of Marking	IEC 60115-1 4.30 IPA for 5±0.5 Min. with ultrasonic	No deterioration of coatings and markings
Robustness of Terminations	IEC 60115-1 4.16 Direct load for 10 Sec. in the direction of the terminal leads	≥2.5kg (24.5N)
Periodic-pulse Overload	IEC 60115-1 4.39 4 times RCWV 10,000 cycles (1 Sec. on, 25 Sec. off)	±1.0%+0.05Ω
Damp Heat Steady State	IEC 60115-1 4.24 40±2°C, 90-95% RH for 56 days, loaded with 0.1 times RCWV	±5.0%+0.05Ω
Endurance at 70°C	IEC 60115-1 4.25 70±2°C at RCWV for 1,000 Hr. (1.5 Hr. on, 0.5 Hr. off)	±5.0%+0.05Ω
Temperature Cycling	IEC 60115-1 4.19 -55°C ⇌ Room Temp. ⇌ +155°C ⇌ Room Temp. (5 cycles)	±1.0%+0.05Ω
Resistance to Soldering Heat	IEC 60115-1 4.18 260±3°C for 10±1 Sec., immersed to a point 3±0.5mm from the body	±1.0%+0.05Ω
Accidental Overload Test	IEC 60115-1 4.26 4 times RCWV for 1 Min.	No evidence of flaming or arcing

Note: RCWV(Rated Continuous Working Voltage) = $\sqrt{\text{Power Rating} \times \text{Resistance Value}}$ or Max. working voltage listed above, whichever less.

Revision: 201304

Pulse-Loading Resistors

Anti-Pulse Type

Normal & Miniature Style [APR Series]

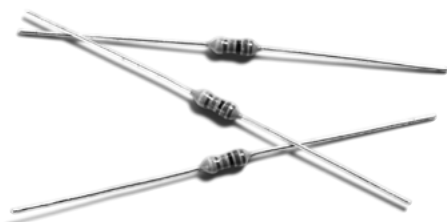

INTRODUCTION

The APR Series Pulse-Loading Resistors have excellent capability in withstanding pulse; tinned connecting leads of electrolytic copper are welded to the end-caps. The resistors are coated with layers of gray color lacquer. The 5th color band is yellow to represent APR series.

FEATURES

Power Rating	1/4W, 1/2W, 1W, 2W, 3W
Resistance Tolerance	5%
T.C.R.	$\pm 300\text{ppm}/^{\circ}\text{C}$
Flameproof Multi-layer Coating Meets	UL-94V-0
Flameproof Feature Meets Overload Test	UL-1412

DERATING CURVE

For resistors operated in ambient temperatures above 70°C, power rating must be derated in accordance with the curve below.

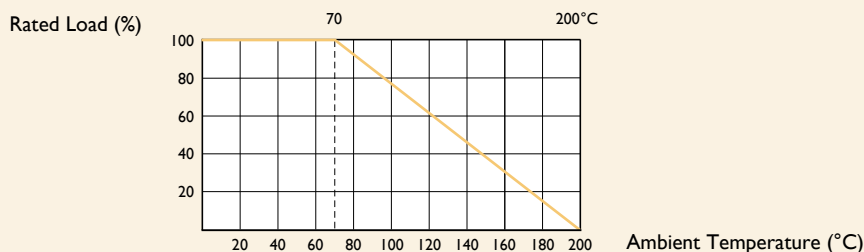

DIMENSIONS

Unit: mm

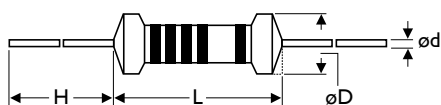

5th color code: yellow

STYLE		DIMENSION			
Normal	Miniature	L	øD	H	ød
APR-25	APR50S	6.3±0.5	2.4±0.2	28±2.0	0.55±0.05
APR-50	APR1WS	9.0±0.5	3.3±0.3	26±2.0	0.55±0.05
APR100	APR2WS	11.5±1.0	4.5±0.5	35±2.0	0.80±0.05
APR200	APR3WS	15.5±1.0	5.0±0.5	33±2.0	0.80±0.05

Note:

ELECTRICAL CHARACTERISTICS

STYLE	APR-25	APR50S	APR-50	APRIWS	APRI00	APR2WS	APR200	APR3WS
Power Rating at 70°C	1/4W	1/2W		1W		2W		3W
Maximum Working Voltage	$\sqrt{P \times R}$							
Voltage Proof on Insulation	400V			500V				
Resistance Range	1Ω - 100KΩ & 0Ω for E24 series value							
Operating Temp. Range	-55°C to +200°C							
Temperature Coefficient	±300ppm/°C							

Note: Special value is available on request

ENVIRONMENTAL CHARACTERISTICS

PERFORMANCE TEST	TEST METHOD	APPRAISE
Short Time Overload	IEC 60115-1 4.13 2.5 times RCWV for 5 Sec.	±0.75%+0.05Ω
Voltage Proof on Insulation	IEC 60115-1 4.7 in V-block for 60 Sec., test voltage by type	By type
Temperature Coefficient	IEC 60115-1 4.8 -55°C to +155°C	By type
Insulation Resistance	IEC 60115-1 4.6 in V-block for 60 Sec.	>10,000M
Solderability	IEC 60115-1 4.17 235±5°C for 3±0.5 Sec.	95% Min. coverage
Solvent Resistance of Marking	IEC 60115-1 4.30 IPA for 5±0.5 Min. with ultrasonic	No deterioration of coatings and markings
Robustness of Terminations	IEC 60115-1 4.16 Direct load for 10 Sec. in the direction of the terminal leads	≥2.5kg (24.5N)
Periodic-pulse Overload	IEC 60115-1 4.39 4 times RCWV 10,000 cycles (1 Sec. on, 25 Sec. off)	±1.0%+0.05Ω
Damp Heat Steady State	IEC 60115-1 4.24 40±2°C, 90-95% RH for 56 days, loaded with 0.1 times RCWV	±3.0%+0.05Ω
Endurance at 70°C	IEC 60115-1 4.25 70±2°C at RCWV for 1,000 Hr. (1.5 Hr. on, 0.5 Hr. off)	±3.0%+0.05Ω
Temperature Cycling	IEC 60115-1 4.19 -55°C ⇌ Room Temp. ⇌ +155°C ⇌ Room Temp. (5 cycles)	±1.0%+0.05Ω
Resistance to Soldering Heat	IEC 60115-1 4.18 260±3°C for 10±1 Sec., immersed to a point 3±0.5mm from the body	±1.0%+0.05Ω
Accidental Overload Test	IEC 60115-1 4.26 4 times RCWV for 1 Min.	No evidence of flaming or arcing

Note: RCWV(Rated Continuous Working Voltage) = $\sqrt{\text{Power Rating} \times \text{Resistance Value}}$ or Max. working voltage listed above, whichever less.

Zero Ohm Resistors

Coating Type

Normal Style [ZOR Series]



INTRODUCTION

- Similar to a 1/4W resistor (1/6W size also available)
- Ideal for automatic insertion or Cut and Form
- Available in Tape/Reel, Tape/Box and Bulk
- Products meet EU-RoHS requirements

SPECIFICATIONS

Power Rating	1/6W, 1/4W	
Maximum Resistance	20mΩ or less	
Min. Insulation Resistance	Dry	10,000MΩ
	Wet	100MΩ
Min. Dielectric Withstanding Voltage	Atmospheric	500V RMS
	Reduced	325V RMS
Insulation Flammability	Resistor insulation is self extinguishing within 10 Sec. after externally applied flame is removed	
Current Rating	10 AMPS at 70°C for 1/4W	
	8 AMPS at 70°C for 1/6W	

DERATING CURVE

For resistors operated in ambient temperatures above 70°C, power rating must be derated in accordance with the curve below.

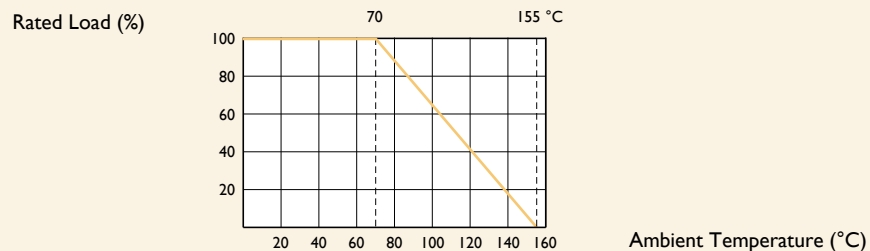

DIMENSIONS

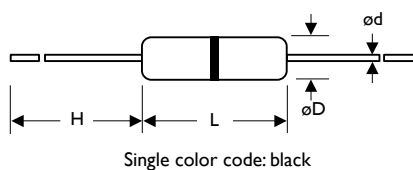

Unit: mm

STYLE	DIMENSION			
	L	øD	H	ød
Normal				
ZOR-12	3.3±0.4	1.8±0.3	28±2.0	0.45±0.05
ZOR-25	6.3±0.5	2.3±0.3	28±2.0	0.55±0.05

Tinned-Copper Wire Type

Normal Style [JPW Series]

Jumper Wires

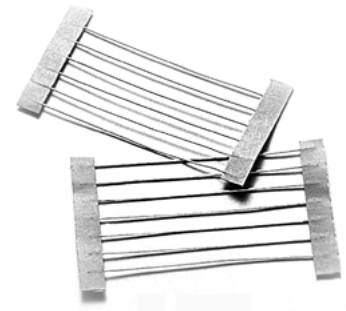

SPECIFICATIONS

Material of Jumper Wire	Soft copper wire with tin plating		
Wire Diameter	$\varnothing 0.5, \varnothing 0.6, \varnothing 0.7, \varnothing 0.8, \varnothing 1.0$ ($\pm 0.05\text{mm}$)		
Tension Strength	CNS 8938 within 28kg/mm ²		
Extension Rate	CNS 8938 $\varnothing 0.5$ to $\varnothing 0.6\text{mm}$	over 24%	
	CNS 8938 $\varnothing 0.7$ to $\varnothing 1.0\text{mm}$	over 26%	
Conductivity	$\varnothing 0.5\text{mm}$	Minimum 94%	
	$\varnothing 0.6$ to $\varnothing 1.0\text{mm}$	Minimum 96%	
Twisting Strength	CNS 8938 $\varnothing 0.5\text{mm}$	Load 250g	3 cycles
	CNS 8938 $\varnothing 0.6$ to $\varnothing 0.8\text{mm}$	Load 500g	3 cycles
	CNS 8938 $\varnothing 1.0\text{mm}$	Load 1.0kg	3 cycles
Solderability	235 \pm 5°C, 3 \pm 0.5 Sec. coverage 95%		
Element of Plating	Tin Minimum 99.9%		
Thickness of Plating	4 \pm 1 μm		
	$\varnothing 0.5\text{mm}$	6 AMPS at 70°C	
	$\varnothing 0.6\text{mm}$	7.5 AMPS at 70°C	
	$\varnothing 0.7\text{mm}$	8.5 AMPS at 70°C	
	$\varnothing 0.8\text{mm}$	10 AMPS at 70°C	
Current Rating	$\varnothing 1.0\text{mm}$	15 AMPS at 70°C	
	Appearance		
	Smooth and shining		

INTRODUCTION

Jumper wires or crossovers, as they are sometimes called, are basically interconnection devices between points on a PC Board. Generally they are used for the following reasons:

- Inability to connect two points on a PC Board due to other circuit paths which must be crossed over
- An After-the-Fact design change that requires new point connections
- Circuit tuning by changing point connections

Jumper wires offers a quick simple solution to these problems. They are especially suited for automatic machine insertion on lead tape, and are available in all packaging styles, including pre-cut and formed leads, for manual insertion.

- Products meet EU-RoHS requirements

DIMENSIONS

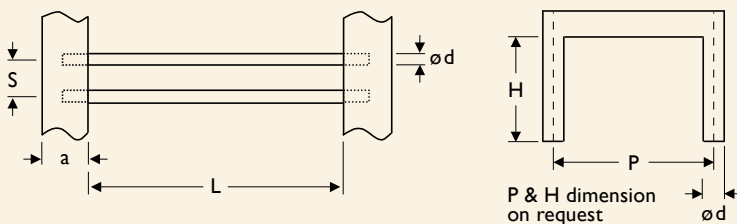

Unit: mm

STYLE	DIMENSION				
	Normal	$\varnothing d$	L	S	a
JPW-05		0.5 \pm 0.05			
JPW-06		0.6 \pm 0.05	26.0 \pm 1.0		
JPW-07		0.7 \pm 0.05	52.4 \pm 1.0	5.0 \pm 0.1	6.0 \pm 0.5
JPW-08		0.8 \pm 0.05	73.0 \pm 1.5		
JPW-10		1.0 \pm 0.05			

Revision: 201304

Low Ohmic Wire Resistors

Alloy-Wire Type

Normal Style [MCW Series]



INTRODUCTION

- The Low Ohmic Alloy-Wire Resistors are suitable for high power current detection, it is non-inductive type
- Low Ohmic Wire Resistors meet EU-RoHS requirements

FEATURES

Material	Manganese-copper, Nickel-copper, others upon request
Resistance Tolerance	±2%, ±5%
T.C.R.	±50ppm/°C, ±100ppm/°C, ±200ppm/°C

DIMENSIONS

Unit: mm

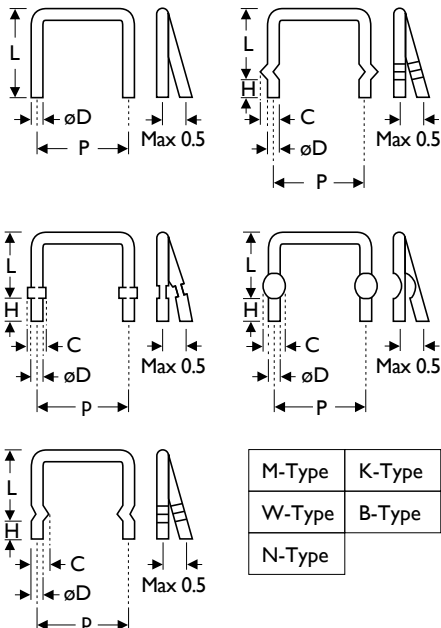

STYLE	DIMENSION			
	øD	C	H	P, L
MCW-06	0.6±0.02	0.9±0.1	3.0±0.5	P & L could be designed by customer's requirement
MCW-08	0.8±0.02	1.1±0.1	3.0±0.5	
MCW-10	1.0±0.02	1.3±0.1	3.0±0.5	
MCW-12	1.2±0.02	1.5±0.1	3.0±0.5	
MCW-14	1.4±0.02	1.7±0.1	3.0±0.5	
MCW-16	1.6±0.02	1.9±0.2	3.0±0.5	
MCW-18	1.8±0.02	2.2±0.2	3.0±0.5	
MCW-20	2.0±0.02	2.5±0.2	3.0±0.5	
MCW-26	2.6±0.02	3.2±0.2	3.0±0.5	

Note:

ELECTRICAL CHARACTERISTICS

STYLE	MCW-06	MCW-08	MCW-10	MCW-12	MCW-14	MCW-16	MCW-18	MCW-20	MCW-26
Maximum Current Rating	3A	4.5A	5.5A	7.0A	8.0A	9.5A	11A	12A	18A
Resistance Range	0.0014Ω - 0.078Ω								
Operating Temp. Range	-40°C to +170°C								
Temperature Coefficient	±50ppm/°C, ±100ppm/°C, ±200ppm/°C								

Note: Below or over this resistance value is available on request

ENVIRONMENTAL CHARACTERISTICS

PERFORMANCE TEST	TEST METHOD		APPRAISE
Short Time Overload	IEC 60115-1 4.13	2.5 times RCWV for 5 Sec.	±2%
Temperature Coefficient	IEC 60115-1 4.8	-55°C to +125°C	By type
Solderability	IEC 60115-1 4.17	235±5°C for 3±0.5 Sec.	95% Min. coverage
Damp Heat Steady State	IEC 60115-1 4.24	40±2°C, 90-95% RH for 56 days, loaded with 0.1 times RCWV	±2.0%
Endurance at 70°C	IEC 60115-1 4.25	70±2°C at RCWV for 1,000 Hr. (1.5 Hr. on, 0.5 Hr. off)	±3.0%
Temperature Cycling	IEC 60115-1 4.19	-55°C ⇌ Room Temp. ⇌ +155°C ⇌ Room Temp. (5 cycles)	±1.0%
Resistance to Soldering Heat	IEC 60115-1 4.18	260±3°C for 10±1 Sec., immersed to a point 3±0.5mm from the body	±1.0%

Note: RCWV(Rated Continuous Working Voltage) = $\sqrt{\text{Power Rating} \times \text{Resistance Value}}$ or Max. working voltage listed above, whichever less.

Wirewound Resistors

General Type

Normal & Miniature Style [KNP Series]

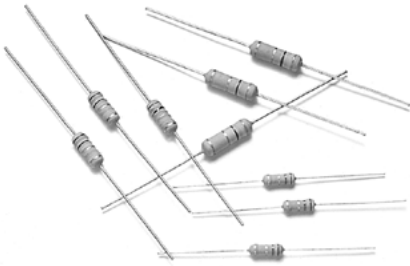

INTRODUCTION

The resistor element is a resistive wire which is wound in a single layer on a ceramic rod, with tinned connecting wires of electrolytic copper welded to the end-caps. The ends of the resistive wire are connected to the caps by welding. The resistors are coated with layers of green color flame-proof lacquer.

FEATURES

Power Rating	1/4W, 1/2W, 1W, 2W, 3W, 4W, 5W, 7W
Resistance Tolerance	±1%, ±5%
T.C.R.	±300ppm/°C
Flameproof Multi-layer Coating Meets	UL-94V-0
Flameproof Feature Meets Overload Test	UL-1412

DERATING CURVE

For resistors operated in ambient temperatures above 40°C, power rating must be derated in accordance with the curve below.

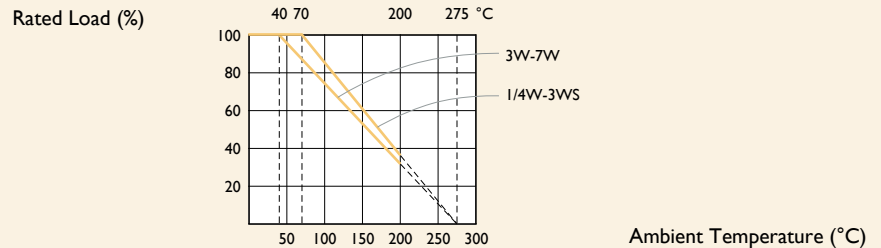

DIMENSIONS

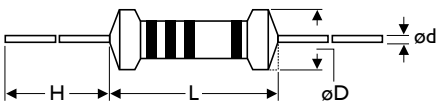

Unit: mm

STYLE		DIMENSION			
Normal	Miniature	L	øD	H	ød
KNP-25	KNP50S	6.3±0.5	2.5±0.3	28±2.0	0.55±0.05
KNP-50	KNP1WS	9.0±0.5	3.5±0.3	26±2.0	0.55±0.05
KNP100	KNP2WS KNP3SS	11.5±1.0	4.6±0.5	35±2.0	0.8±0.05
KNP200	KNP3WS	15.5±1.0	5.2±0.5	33±2.0	0.8±0.05
KNP300	KNP5WS	17.5±1.0	6.5±0.5	32±2.0	0.8±0.05
KNP400					
KNP500	KNP7WS	24.5±1.0	8.5±0.5	38±2.0	0.8±0.05
KNP600					
KNP700	-	24.5±1.0	8.5±0.5	38±2.0	0.8±0.05

Note: KNP1WS (for MBType) ød = 0.8±0.05 mm

ELECTRICAL CHARACTERISTICS

NORMAL STYLE

STYLE	KNP-25	KNP-50	KNP100	KNP200	KNP300	KNP400	KNP500	KNP600	KNP700
Power Rating at 40°C					3W	4W	5W	6W	7W
Power Rating at 70°C	1/4W	1/2W	1W	2W					
Maximum working voltage	$\sqrt{P \times R}$								
Voltage Proof on Insulation	250V	300V	400V						
Resistance Range ($\pm 1\%$)	0.1 Ω - 150 Ω	0.1 Ω - 750 Ω	0.1 Ω - 1.5K Ω	0.1 Ω - 2.4K Ω	0.1 Ω - 3.3K Ω		0.1 Ω - 6.2K Ω		
Resistance Range ($\pm 5\%$)	0.1 Ω - 200 Ω	0.1 Ω - 800 Ω	0.1 Ω - 2.2K Ω	0.1 Ω - 2.7K Ω	0.1 Ω - 3.9K Ω		0.1 Ω - 6.8K Ω		
Operating Temp. Range	-40°C to +200°C								
Temperature Coefficient	$\pm 300\text{ppm}/^\circ\text{C}$								

Note: Special value is available on request

MINIATURE STYLE

STYLE	KNP50S	KNP1WS	KNP2WS	KNP3SS	KNP3WS	KNP5WS	KNP7WS
Power Rating at 40°C						5W	7W
Power Rating at 70°C	1/2W	1W	2W	3W			
Maximum working voltage	$\sqrt{P \times R}$						
Voltage Proof on Insulation	200V	300V	400V				
Resistance Range ($\pm 1\%$)	0.1 Ω - 150 Ω	0.1 Ω - 750 Ω	0.1 Ω - 1.5K Ω		0.1 Ω - 2.4K Ω	0.1 Ω - 3.3K Ω	
Resistance Range ($\pm 5\%$)	0.1 Ω - 200 Ω	0.1 Ω - 800 Ω	0.1 Ω - 2.2K Ω		0.1 Ω - 2.7K Ω	0.1 Ω - 3.9K Ω	
Operating Temp. Range	-40°C to +200°C						
Temperature Coefficient	$\pm 300\text{ppm}/^\circ\text{C}$						

Note: Special value is available on request

ENVIRONMENTAL CHARACTERISTICS

PERFORMANCE TEST	TEST METHOD		APPRAISE
Short Time Overload	IEC 60115-1 4.13	10 times rated power for 5 Sec.	$\pm 2.0\% + 0.05\Omega$
Voltage Proof on Insulation	IEC 60115-1 4.7	in V-block for 60 Sec., test voltage by type	By type
Temperature Coefficient	IEC 60115-1 4.8	-55°C to +155°C	By type
Insulation Resistance	IEC 60115-1 4.6	in V-block for 60 Sec.	>100M Ω
Solderability	IEC 60115-1 4.17	235 $\pm 5^\circ\text{C}$ for 3 ± 0.5 Sec	95% Min. coverage
Solvent Resistance of Marking	IEC 60115-1 4.30	IPA for 5 ± 0.5 Min. with ultrasonic	No deterioration of coatings and markings
Robustness of Terminations	IEC 60115-1 4.16	Direct load for 10 Sec. in the direction of the terminal leads	$\geq 2.5\text{kg}$ (24.5N)
Damp Heat Steady State	IEC 60115-1 4.24	40 $\pm 2^\circ\text{C}$, 90-95% RH for 56 days, loaded with 0.1 times RCWV	$\pm 5.0\% + 0.05\Omega$
Endurance at 70°C	IEC 60115-1 4.25	70 $\pm 2^\circ\text{C}$ at RCWV for 1,000 Hr. (1.5 Hr. on, 0.5 Hr. off)	$\pm 5.0\% + 0.05\Omega$
Temperature Cycling	IEC 60115-1 4.19	-55°C \Rightarrow Room Temp. \Rightarrow +155°C \Rightarrow Room Temp. (5 cycles)	$\pm 1.0\% + 0.05\Omega$
Resistance to Soldering Heat	IEC 60115-1 4.18	260 $\pm 3^\circ\text{C}$ for 10 ± 1 Sec., immersed to a point 3 $\pm 0.5\text{mm}$ from the body	$\pm 1.0\% + 0.05\Omega$
Accidental Overload Test	IEC 60115-1 4.26	4 times RCWV for 1 Min.	No evidence of flaming or arcing

Note: Rated Continuous Working Voltage (RCWV) = $\sqrt{\text{Power Rating} \times \text{Resistance Value}}$ or Max. working voltage listed above, whichever less.

Wirewound Resistors

Flame-Proof & Non-Inductive Type

Normal & Miniature Style [NKN Series]

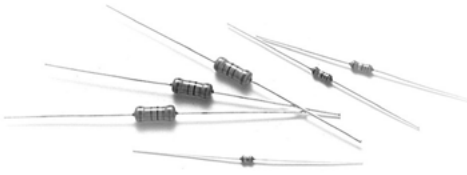

INTRODUCTION

The resistor element is a resistive wire which is wound in a single layer on a ceramic rod, with tinned connecting wires of electrolytic copper welded to the end-caps. The ends of the resistive wire are connected to the caps by welding. The resistors are coated with layers of green color flame-proof lacquer. The 5th color band is black to represent NKN series.

FEATURES

Power Rating	1/2W, 1W, 2W, 3W, 4W, 5W, 7W
Resistance Tolerance	±5%
T.C.R.	±300ppm/°C
Flameproof Multi-layer Coating Meets	UL-94V-0
Flameproof Feature Meets Overload Test	UL-1412

DERATING CURVE

For resistors operated in ambient temperatures above 40°C, power rating must be derated in accordance with the curve below.

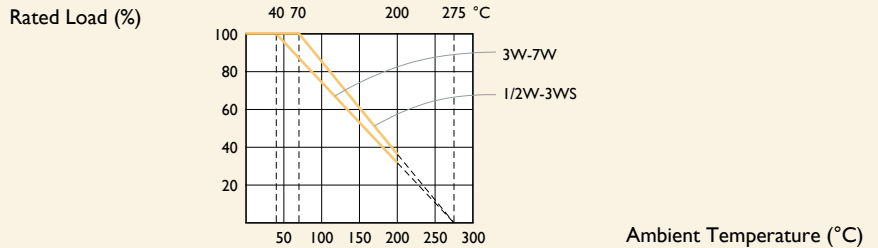

DIMENSIONS

Unit: mm

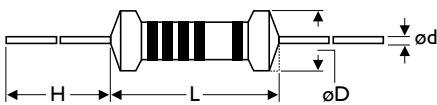

5th color code: black

STYLE		DIMENSION			
Normal	Miniature	L	øD	H	ød
NKN-50	NKN1WS	9.0±0.5	3.5±0.3	26±2.0	0.55±0.05
NKN100	NKN2WS	11.5±1.0	4.8±0.5	35±2.0	0.8±0.05
NKN200	NKN3WS	15.5±1.0	5.3±0.5	33±2.0	0.8±0.05
NKN300					
NKN400	NKN5WS	17.5±1.0	6.5±0.5	32±2.0	0.8±0.05
NKN500	NKN7WS	24.5±1.0	8.5±0.5	38±2.0	0.8±0.05

ELECTRICAL CHARACTERISTICS

NORMAL STYLE

STYLE	NKN-50	NKN100	NKN200	NKN300	NKN400	NKN500
Power Rating at 40°C				3W	4W	5W
Power Rating at 70°C	1/2W	1W	2W			
Maximum working voltage	$\sqrt{P \times R}$					
Voltage Proof on Insulation	250V	400V				
Resistance Range	0.08Ω - 15Ω	0.1Ω - 40Ω	0.1Ω - 90Ω	0.1Ω - 120Ω		0.18Ω - 220Ω
Operating Temp. Range	-40°C to +200°C					
Temperature Coefficient	±300ppm/°C					

Note: Special value is available on request

MINIATURE STYLE

STYLE	NKNIWS	NKN2WS	NKN3WS	NKN5WS	NKN7WS
Power Rating at 40°C				5W	7W
Power Rating at 70°C	1W	2W	3W		
Maximum working voltage	$\sqrt{P \times R}$				
Voltage Proof on Insulation	250V	400V			
Resistance Range	0.08Ω - 15Ω	0.1Ω - 40Ω	0.1Ω - 90Ω	0.1Ω - 120Ω	0.18Ω - 220Ω
Operating Temp. Range	- 40°C to +200°C				
Temperature Coefficient	±300ppm/°C				

Note: Special value is available on request

ENVIRONMENTAL CHARACTERISTICS

PERFORMANCE TEST	TEST METHOD		APPRAISE
Short Time Overload	IEC 60115-1 4.13	10 times rated power for 5 Sec.	±2.0%+0.05Ω
Voltage Proof on Insulation	IEC 60115-1 4.7	in V-block for 60 Sec., test voltage by type	By type
Temperature Coefficient	IEC 60115-1 4.8	-55°C to +155°C	By type
Insulation Resistance	IEC 60115-1 4.6	in V-block for 60 Sec.	>100MΩ
Solderability	IEC 60115-1 4.17	235±5°C for 3±0.5 Sec.	95% Min. coverage
Solvent Resistance of Marking	IEC 60115-1 4.30	IPA for 5±0.5 Min. with ultrasonic	No deterioration of coatings and markings
Robustness of Terminations	IEC 60115-1 4.16	Direct load for 10 Sec. in the direction of the terminal leads	≥2.5kg (24.5N)
Damp Heat Steady State	IEC 60115-1 4.24	40±2°C, 90-95% RH for 56 days, loaded with 0.1 times RCWV	±5.0%+0.05Ω
Endurance at 70°C	IEC 60115-1 4.25	70±2°C at RCWV for 1,000 Hr. (1.5 Hr. on, 0.5 Hr. off)	±5.0%+0.05Ω
Temperature Cycling	IEC 60115-1 4.19	-55°C ⇌ Room Temp. ⇌ +155°C ⇌ Room Temp. (5 cycles)	±1.0%+0.05Ω
Resistance to Soldering Heat	IEC 60115-1 4.18	260±3°C for 10±1 Sec., immersed to a point 3±0.5mm from the body	±1.0%+0.05Ω
Accidental Overload Test	IEC 60115-1 4.26	4 times RCWV for 1 Min.	No evidence of flaming or arcing

Note: Rated Continuous Working Voltage (RCWV) = $\sqrt{\text{Power Rating} \times \text{Resistance Value}}$ or Max. working voltage listed above, whichever less.

Wirewound Resistors

Fusible & Flame-Proof Type

Normal & Miniature Style [FKN Series]

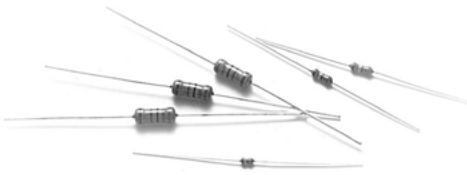

INTRODUCTION

The resistor element is a resistive wire which is wound in a single layer on a ceramic rod, with tinned connecting wires of electrolytic copper welded to the end-caps. The ends of the resistive wire are connected to the caps by welding. The resistors are coated with layers of green color flame-proof lacquer. Overload protection without risk of fire. Wide range of overload currents.

FEATURES

Power Rating	1/2W, 1W, 2W, 3W, 4W, 5W, 7W
Resistance Tolerance	±1%, ±5%
T.C.R.	±350ppm/°C
Flameproof Multi-layer Coating Meets	UL-94V-0
Flameproof Feature Meets Overload Test	UL-1412

DERATING CURVE

For resistors operated in ambient temperatures above 40°C, power rating must be derated in accordance with the curve below.

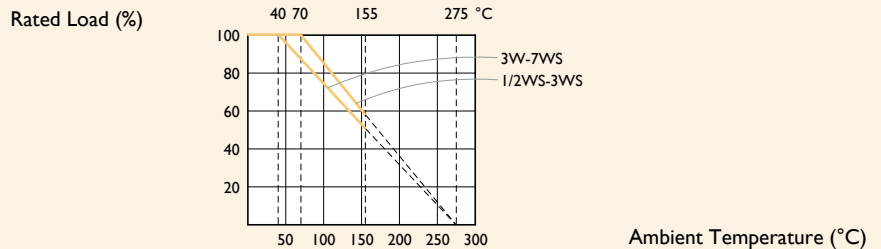

FUSING CHARACTERISTICS

$R \leq 2.0\Omega$ Fusing time within 60 seconds at 36 times of rated power

$R > 2.0\Omega$ Fusing time within 60 seconds at 25 times of rated power

Fusing residual resistive value at least 100 times rated resistance

DIMENSIONS

Unit: mm

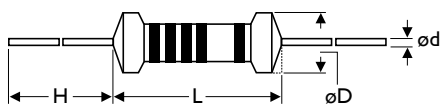

5th color code: white

STYLE	DIMENSION					
	Normal	Miniature	L	øD	H	ød
-		FKN50S	6.3±0.5	2.5±0.3	28±2.0	0.55±0.05
FKN-50		FKN1WS	9.0±0.5	3.5±0.3	26±2.0	0.55±0.05
FKN100		FKN2WS	11.5±1.0	4.6±0.5	35±2.0	0.8±0.05
FKN200		FKN3WS	15.5±1.0	5.2±0.5	33±2.0	0.8±0.05
FKN300						
FKN400		FKN5WS	17.5±1.0	6.5±0.5	32±2.0	0.8±0.05
FKN500		FKN7WS	24.5±1.0	8.5±0.5	38±2.0	0.8±0.05

Note: FKN1WS (for MBType) ød = 0.8±0.05 mm

ELECTRICAL CHARACTERISTICS

NORMAL STYLE

STYLE	FKN-50	FKN100	FKN200	FKN300	FKN400	FKN500
Power Rating at 40°C				3W	4W	5W
Power Rating at 70°C	1/2W	1W	2W			
Maximum working voltage	$\sqrt{P \times R}$					
Voltage Proof on Insulation	300V					
Resistance Range ($\pm 1\%$)		0.5 Ω - 100 Ω	0.47 Ω - 150 Ω	0.56 Ω - 330 Ω		1 Ω - 620 Ω
Resistance Range ($\pm 5\%$)	0.5 Ω - 47 Ω	0.5 Ω - 100 Ω	0.47 Ω - 150 Ω	0.56 Ω - 330 Ω		1 Ω - 620 Ω
Operating Temp. Range	-40°C to +155°C					
Temperature Coefficient	± 350 ppm/°C					

Note: Special value is available on request

MINIATURE STYLE

STYLE	FKN50S	FKN1WS	FKN2WS	FKN3WS	FKN5WS	FKN7WS
Power Rating at 40°C					5W	7W
Power Rating at 70°C	1/2W	1W	2W	3W		
Maximum working voltage	$\sqrt{P \times R}$					
Voltage Proof on Insulation	200V	300V				
Resistance Range ($\pm 1\%$)		0.47 Ω - 62 Ω	0.47 Ω - 150 Ω	0.47 Ω - 240 Ω	0.56 Ω - 330 Ω	1 Ω - 620 Ω
Resistance Range ($\pm 5\%$)	2.5 Ω - 22 Ω	0.47 Ω - 62 Ω	0.47 Ω - 150 Ω	0.47 Ω - 240 Ω	0.56 Ω - 330 Ω	1 Ω - 620 Ω
Operating Temp. Range	-40°C to +155°C					
Temperature Coefficient	± 350 ppm/°C					

Note: Special value is available on request

ENVIRONMENTAL CHARACTERISTICS

PERFORMANCE TEST	TEST METHOD		APPRAISE
Short Time Overload	IEC 60115-1 4.13	10 times rated power for 5 Sec.	$\pm 2.0\% + 0.05\Omega$
Voltage Proof on Insulation	IEC 60115-1 4.7	in V-block for 60 Sec., test voltage by type	By type
Temperature Coefficient	IEC 60115-1 4.8	-55°C to +155°C	By type
Insulation Resistance	IEC 60115-1 4.6	in V-block for 60 Sec.	>100M Ω
Solderability	IEC 60115-1 4.17	235 ± 5 °C for 3 ± 0.5 Sec.	95% Min. coverage
Solvent Resistance of Marking	IEC 60115-1 4.30	IPA for 5 ± 0.5 Min. with ultrasonic	No deterioration of coatings and markings
Robustness of Terminations	IEC 60115-1 4.16	Direct load for 10 Sec. in the direction of the terminal leads	≥ 2.5 kg (24.5N)
Damp Heat Steady State	IEC 60115-1 4.24	40 ± 2 °C, 90-95% RH for 56 days, loaded with 0.1 times RCWV	$\pm 5.0\% + 0.05\Omega$
Endurance at 70°C	IEC 60115-1 4.25	70 ± 2 °C at RCWV for 1,000 Hr. (1.5 Hr. on, 0.5 Hr. off)	$\pm 5.0\% + 0.05\Omega$
Temperature Cycling	IEC 60115-1 4.19	-55°C \Rightarrow Room Temp. \Rightarrow +155°C \Rightarrow Room Temp. (5 cycles)	$\pm 1.0\% + 0.05\Omega$
Resistance to Soldering Heat	IEC 60115-1 4.18	260 ± 3 °C for 10 ± 1 Sec., immersed to a point 3 ± 0.5 mm from the body	$\pm 1.0\% + 0.05\Omega$
Accidental Overload Test	IEC 60115-1 4.26	4 times RCWV for 1 Min.	No evidence of flaming or arcing

Note: Rated Continuous Working Voltage (RCWV) = $\sqrt{\text{Power Rating} \times \text{Resistance Value}}$ or Max. working voltage listed above, whichever less.

Revision: 201304

Wirewound Resistors

High Power Type

Ultra Miniature Style [PNP Series]

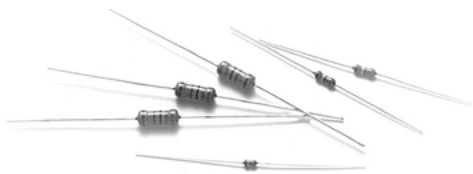

INTRODUCTION

The resistor element is a resistive wire which is wound in a single layer on a ceramic rod, with tinned connecting wires of electrolytic copper welded to the end-caps. The ends of the resistive wire are connected to the caps by welding. The resistors are coated with layers of green color flame-proof lacquer. High power in small packages.

FEATURES

Power Rating	1W, 2W, 3W, 4W
Resistance Tolerance	±1%, ±5%
T.C.R.	±300ppm/°C
Flameproof Multi-layer Coating Meets	UL-94V-0
Flameproof Feature Meets Overload Test	UL-1412

DERATING CURVE

For resistors operated in ambient temperatures above 70°C, power rating must be derated in accordance with the curve below.

Rated Load (%)

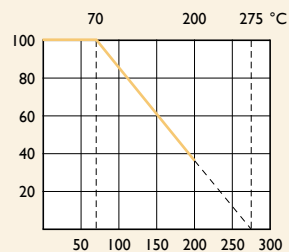

Ambient Temperature (°C)

DIMENSIONS

Unit: mm

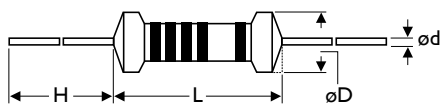

5th color code: violet

STYLE	DIMENSION			
	L	øD	H	ød
Ultra Miniature				
PNP100	6.3±0.5	2.5±0.3	28±2.0	0.55±0.05
PNP200	9.0±0.5	3.5±0.3	26±2.0	0.55±0.05
PNP300	11.5±1.0	4.6±0.5	35±2.0	0.8±0.05
PNP400	15.5±1.0	5.2±0.5	33±2.0	0.8±0.05

Note:

ELECTRICAL CHARACTERISTICS

STYLE	PNP100	PNP200	PNP300	PNP400
Power Rating at 70°C	1W	2W	3W	4W
Maximum working voltage	$\sqrt{P \times R}$			
Voltage Proof on Insulation	300V			
Resistance Range ($\pm 1\%$)	0.22 Ω - 130 Ω	0.1 Ω - 820 Ω	0.1 Ω - 2.2K Ω	0.1 Ω - 2.8K Ω
Resistance Range ($\pm 5\%$)	0.1 Ω - 130 Ω	0.1 Ω - 820 Ω	0.1 Ω - 2.2K Ω	0.1 Ω - 2.8K Ω
Operating Temp. Range	-40°C to +200°C			
Temperature Coefficient	$\pm 300\text{ppm}/^\circ\text{C}$			

Note: Special value is available on request

ENVIRONMENTAL CHARACTERISTICS

PERFORMANCE TEST	TEST METHOD	APPRAISE
Short Time Overload	IEC 60115-1 4.13 10 times rated power for 5 Sec.	$\pm 2.0\% + 0.05\Omega$
Voltage Proof on Insulation	IEC 60115-1 4.7 in V-block for 60 Sec., test voltage by type	By type
Temperature Coefficient	IEC 60115-1 4.8 -55°C to +155°C	By type
Insulation Resistance	IEC 60115-1 4.6 in V-block for 60 Sec.	>100M Ω
Solderability	IEC 60115-1 4.17 235 $\pm 5^\circ\text{C}$ for 3 ± 0.5 Sec.	95% Min. coverage
Solvent Resistance of Marking	IEC 60115-1 4.30 IPA for 5 ± 0.5 Min. with ultrasonic	No deterioration of coatings and markings
Robustness of Terminations	IEC 60115-1 4.16 Direct load for 10 Sec. in the direction of the terminal leads	$\geq 2.5\text{kg}$ (24.5N)
Damp Heat Steady State	IEC 60115-1 4.24 40 $\pm 2^\circ\text{C}$, 90-95% RH for 56 days, loaded with 0.1 times RCWV	$\pm 5.0\% + 0.05\Omega$
Endurance at 70°C	IEC 60115-1 4.25 70 $\pm 2^\circ\text{C}$ at RCWV for 1,000 Hr. (1.5 Hr. on, 0.5 Hr. off)	$\pm 5.0\% + 0.05\Omega$
Temperature Cycling	IEC 60115-1 4.19 -55°C \Rightarrow Room Temp. \Rightarrow +155°C \Rightarrow Room Temp. (5 cycles)	$\pm 1.0\% + 0.05\Omega$
Resistance to Soldering Heat	IEC 60115-1 4.18 260 $\pm 3^\circ\text{C}$ for 10 ± 1 Sec., immersed to a point 3 $\pm 0.5\text{mm}$ from the body	$\pm 1.0\% + 0.05\Omega$
Accidental Overload Test	IEC 60115-1 4.26 4 times RCWV for 1 Min.	No evidence of flaming or arcing

Note: RCWV(Rated Continuous Working Voltage) = $\sqrt{\text{Power Rating} \times \text{Resistance Value}}$ or Max. working voltage listed above, whichever less.

Revision: 201304

Wirewound Resistors

High Power Type

Normal Style [PNP V Series]

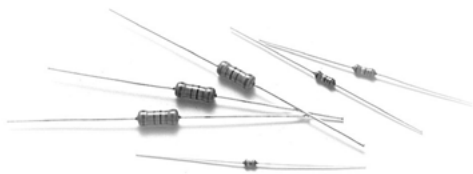

INTRODUCTION

The resistor element is a resistive wire which is wound in a single layer on a ceramic rod, with tinned connecting wires of electrolytic copper welded to the end-caps. The ends of the resistive wire are connected to the caps by welding. The resistors are coated with layers of green color flame-proof lacquer. High power in small package. The 5th color band is violet to represent PNPV series.

FEATURES

Power Rating	1W, 3W, 4W, 5W, 7W, 10W
Resistance Tolerance	±1%, ±5%
T.C.R.	±100ppm/°C, ±300ppm/°C
Flameproof Multi-layer Coating Meets	UL-94V-0
Flameproof Feature Meets Overload Test	UL-1412

DERATING CURVE

For resistors operated in ambient temperatures above 40°C, power rating must be derated in accordance with the curve below.

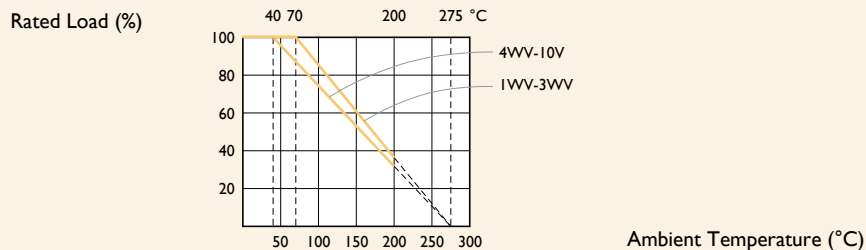

DIMENSIONS

Unit: mm

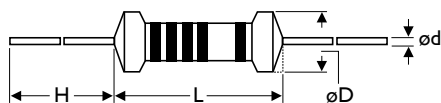

5th color code: violet

STYLE	DIMENSION			
	L	øD	H	ød
PNP1WV	10±1.0	4.3±0.5	26±2.0	0.8±0.05
PNP3WV	13±1.0	5.5±0.5	34±2.0	0.8±0.05
PNP4WV	17±1.0	5.5±0.5	32±2.0	0.8±0.05
PNP5WV	17±1.0	7.5±0.5	32±2.0	0.8±0.05
PNP7WV	25±1.0	7.5±0.5	38±2.0	0.8±0.05
PNP10V	44±1.0	8.0±0.5	28±2.0	0.8±0.05

Note:

ELECTRICAL CHARACTERISTICS

STYLE	PNPIWV	PNP3WV	PNP4WV	PNP5WV	PNP7WV	PNPI0V
Power Rating at 40°C			4W	5W	7W	10W
Power Rating at 70°C	1W	3W				
Maximum working voltage	$\sqrt{P \times R}$					
Voltage Proof on Insulation	300V					
Resistance Range (±1%)	0.1Ω - 1KΩ	0.1Ω - 2.8KΩ	0.1Ω - 4.3KΩ	0.1Ω - 8.2KΩ	0.1Ω - 10KΩ	0.1Ω - 17KΩ
Resistance Range (±5%)	0.047Ω - 1KΩ	0.047Ω - 2.8KΩ	0.047Ω - 4.3KΩ	0.047Ω - 8.2KΩ	0.1Ω - 10KΩ	0.1Ω - 17KΩ
Operating Temp. Range	-40°C to +200°C					
Temperature Coefficient	±300ppm/°C					

Note: Special value is available on request

ENVIRONMENTAL CHARACTERISTICS

PERFORMANCE TEST	TEST METHOD	APPRAISE
Short Time Overload	IEC 60115-1 4.13 10 times rated power for 5 Sec.	±2.0%+0.05Ω
Voltage Proof on Insulation	IEC 60115-1 4.7 in V-block for 60 Sec., test voltage by type	By type
Temperature Coefficient	IEC 60115-1 4.8 -55°C to +155°C	By type
Insulation Resistance	IEC 60115-1 4.6 in V-block for 60 Sec.	>100MΩ
Solderability	IEC 60115-1 4.17 235±5°C for 3±0.5 Sec.	95% Min. coverage
Solvent Resistance of Marking	IEC 60115-1 4.30 IPA for 5±0.5 Min. with ultrasonic	No deterioration of coatings and markings
Robustness of Terminations	IEC 60115-1 4.16 Direct load for 10 Sec. in the direction of the terminal leads	≥2.5kg (24.5N)
Damp Heat Steady State	IEC 60115-1 4.24 40±2°C, 90-95% RH for 56 days, loaded with 0.1 times RCWV	±5.0%+0.05Ω
Endurance at 70°C	IEC 60115-1 4.25 70±2°C at RCWV for 1,000 Hr. (1.5 Hr. on, 0.5 Hr. off)	±5.0%+0.05Ω
Temperature Cycling	IEC 60115-1 4.19 -55°C ⇌ Room Temp. ⇌ +155°C ⇌ Room Temp. (5 cycles)	±1.0%+0.05Ω
Resistance to Soldering Heat	IEC 60115-1 4.18 260±3°C for 10±1 Sec., immersed to a point 3±0.5mm from the body	±1.0%+0.05Ω
Accidental Overload Test	IEC 60115-1 4.26 4 times RCWV for 1 Min.	No evidence of flaming or arcing

Note: RCWV(Rated Continuous Working Voltage) = $\sqrt{\text{Power Rating} \times \text{Resistance Value}}$ or Max. working voltage listed above, whichever less.

Wirewound Resistors

Fusible & Anti-Explosion Type

Normal & Miniature Style [FAE Series]

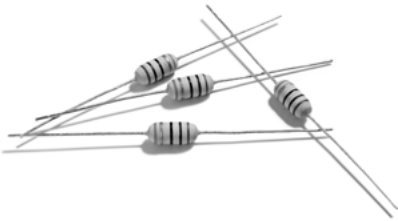

INTRODUCTION

FAE series is wirewound resistor capable of acting both as a regular resistor, and as a fuse when an abnormal current is received. There will be no flames, no explosion, no sound and no arc happened when fusing. FAE series offers space saving and a cost advantage, and is specifically designed to meet customer's requirements.

FEATURES

Power Rating	1/2W, 1W, 2W, 3W
Resistance Tolerance	±1%, ±5%
T.C.R.	±300ppm/°C
Flameproof Multi-layer Coating Meets	UL-94V-0
Flameproof Feature Meets Overload Test	UL-1412

DERATING CURVE

For resistors operated in ambient temperatures above 70°C, power rating must be derated in accordance with the curve below.

Rated Load (%)

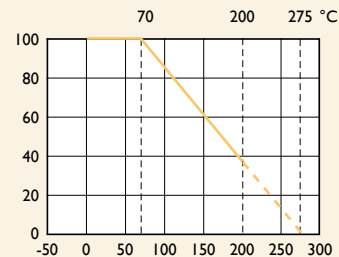

Ambient Temperature (°C)

FUSING CHARACTERISTICS

Fuse within 60 seconds when receiving 25 times the power rating.
(Fusing power and time can be designed on customer's request)

Fusing residual resistive value at least 100 times of rated resistance. No flames, no explosion, no sound and no arc occur when fusing.

DIMENSIONS

Unit: mm

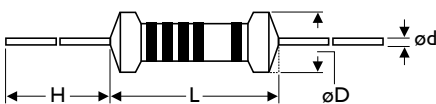

STYLE		DIMENSION			
Normal	Miniature	L	øD	H	ød
-	FAE50S/FAE1SS	6.3±0.5	3.0±0.5	28±2.0	0.55±0.05
FAE-50	FAE1WS	9.0±0.5	3.8±0.5	26±2.0	0.55±0.05
FAE100	FAE2WS	11.5±1.0	5.0±0.5	35±2.0	0.8±0.05
FAE200	FAE3WS	15.5±1.0	5.5±0.5	33±2.0	0.8±0.05

Note:

ELECTRICAL CHARACTERISTICS

STYLE	FAE50S	FAEI5S	FAE-50	FAEIWS	FAEI00	FAE2WS	FAE200	FAE3WS
Power Rating at 70°C	1/2W	1W	1/2W	1W		2W		3W
Maximum Working Voltage	$\sqrt{P \times R}$							
Voltage Proof on Insulation	300V		400V	500V				
Resistance Range	3.3Ω - 100Ω for E24 & E96 series value							
Operating Temp. Range	-55°C to +200°C							
Temperature Coefficient	±300ppm/°C							

Note: Special value is available on request

ENVIRONMENTAL CHARACTERISTICS

PERFORMANCE TEST	TEST METHOD		APPRAISE
Short Time Overload	IEC 60115-1 4.13	10 times rated power for 5 Sec.	±2.0%+0.05Ω
Voltage Proof on Insulation	IEC 60115-1 4.7	in V-block for 60 Sec., test voltage by type	By type
Temperature Coefficient	IEC 60115-1 4.8	-55°C to +155°C	By type
Insulation Resistance	IEC 60115-1 4.6	in V-block for 60 Sec.	> 100M
Solderability	IEC 60115-1 4.17	235±5°C for 3±0.5 Sec.	95% Min. coverage
Solvent Resistance of Marking	IEC 60115-1 4.30	IPA for 5±0.5 Min. with ultrasonic	No deterioration of coatings and markings
Robustness of Terminations	IEC 60115-1 4.16	Direct load for 10 Sec. in the direction of the terminal leads	≥2.5kg (24.5N)
Periodic-pulse Overload	IEC 60115-1 4.39	4 times RCWV 10,000 cycles (1 Sec. on, 25 Sec. off)	±1.0%+0.05Ω
Damp Heat Steady State	IEC 60115-1 4.24	40±2°C, 90-95% RH for 56 days, loaded with 0.1 times RCWV	±5.0%+0.05Ω
Endurance at 70°C	IEC 60115-1 4.25	70±2°C at RCWV for 1,000 Hr. (1.5 Hr. on, 0.5 Hr. off)	±5.0%+0.05Ω
Temperature Cycling	IEC 60115-1 4.19	-55°C ⇌ Room Temp. ⇌ +155°C ⇌ Room Temp. (5 cycles)	±2.0%+0.05Ω
Resistance to Soldering Heat	IEC 60115-1 4.18	260±3°C for 10±1 Sec., immersed to a point 3±0.5mm from the body	±1.0%+0.05Ω
Accidental overload test	IEC 60115-1 4.26	4 times RCWV for 1 Min.	No evidence of flaming or arcing

Note: RCWV(Rated Continuous Working Voltage) = $\sqrt{\text{Power Rating} \times \text{Resistance Value}}$ or Max. working voltage listed above, whichever less.

Cement Resistors

Axial Lead Type

Normal Style [SQP Series]
 Non-Inductive Style [NSP Series]



INTRODUCTION

The materials used and the construction techniques ensure excellent flame resistance, arc resistance and moisture resistance as well as self-extinguishing capabilities. They will withstand the most rigorous loading test.

As resistors in radio and television receivers, hazardous conditions such as smoking and redheat can be completely prevented by the proper choice of power resistors.

FEATURES

Power Rating	2W, 3W, 5W, 7W, 10W, 15W, 20W, 25W, 30W, 40W
Resistance Tolerance	±5%
T.C.R.	±300ppm/°C

DERATING CURVE

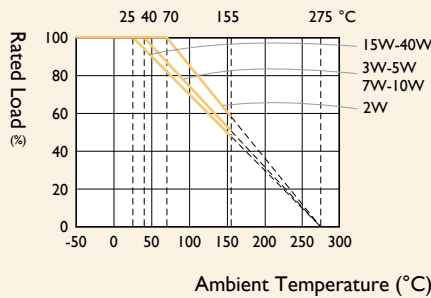

TEMPERATURE RISE

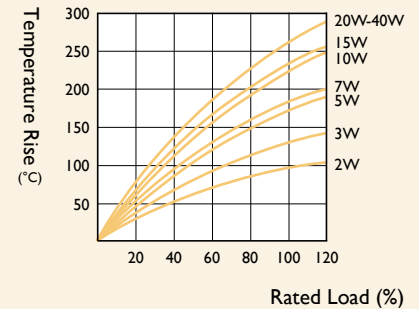

DIMENSIONS

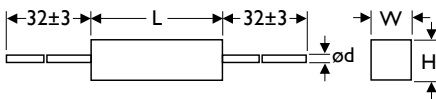

Unit: mm

STYLE		DIMENSION			
Normal	Non-Inductive	L	W	H	ød
SQP200	NSP200	18±1.0	7.0±1.0	7.0±1.0	0.65±0.05
SQP300	NSP300	22±1.5	8.0±1.0	8.0±1.0	0.8±0.05
SQP500	NSP500	22±1.5	9.5±1.0	9.0±1.0	0.8±0.05
SQP700	NSP700	35±1.5	9.5±1.0	9.0±1.0	0.8±0.05
SQP10A	NSP10A	48±1.5	9.5±1.0	9.0±1.0	0.8±0.05
SQP15A	NSP15A	48±1.5	12.5±1.0	12.5±1.0	0.8±0.05
SQP20A	NSP20A	60±5.0	12.5±1.0	12.5±1.0	0.8±0.05
SQP25A	NSP25A	60±5.0	14.0±1.5	13.0±1.5	0.8±0.05
SQP30A	NSP30A	77±5.0	18.0±1.5	17.0±1.5	0.8±0.05
SQP40A	NSP40A	90±5.0	19.0±1.5	18.0±1.5	0.8±0.05

ELECTRICAL CHARACTERISTICS

NORMAL STYLE

STYLE	SQP200	SQP300	SQP500	SQP700	SQP10A	SQP15A	SQP20A	SQP25A	SQP30A	SQP40A
Power Rating at 25°C						15W	20W	25W	30W	40W
Power Rating at 40°C		3W	5W	7W	10W					
Power Rating at 70°C	2W									
Maximum Working Voltage	250V	350V		500V				1,000V		
Maximum Overload Voltage	500V	700V		1,000V				2,000V		
Voltage Proof on Insulation	500V	700V		1,000V				2,000V		
Resistance Range (Wirewound)	0.1Ω - 36Ω	0.1Ω - 68Ω	0.1Ω - 130Ω	0.1Ω - 330Ω	0.1Ω - 510Ω	0.1Ω - 680Ω	0.15Ω - 1KΩ			
Resistance Range (Metal Oxide Film)	39Ω - 1MΩ	75Ω - 1MΩ	150Ω - 1MΩ	360Ω - 1MΩ	560Ω - 1MΩ	750Ω - 1MΩ	1.2KΩ - 1MΩ			
Operating Temp. Range	-55°C to +155°C									
Temperature Coefficient	±300ppm/°C									

NON-INDUCTIVE STYLE

STYLE	NSP200	NSP300	NSP500	NSP700	NSP10A	NSP15A	NSP20A	NSP25A	NSP30A	NSP40A
Power Rating at 25°C						15W	20W	25W	30W	40W
Power Rating at 40°C		3W	5W	7W	10W					
Power Rating at 70°C	2W									
Maximum Working Voltage	$\sqrt{P \times R}$									
Voltage Proof on Insulation	500V	700V		1,000V				2,000V		
Resistance Range (Wirewound)	0.08Ω - 10Ω	0.1Ω - 30Ω	0.1Ω - 40Ω	0.15Ω - 65Ω	0.25Ω - 100Ω	0.25Ω - 120Ω	0.36Ω - 160Ω			
Operating Temp. Range	-55°C to +155°C									
Temperature Coefficient	±300ppm/°C									

Note: Special value is available on request

ENVIRONMENTAL CHARACTERISTICS

PERFORMANCE TEST	TEST METHOD		APPRAISE
Short Time Overload	IEC 60115-1 4.13	2.5 times RCWV for 5 Sec.	±2.0%+0.05Ω
Voltage Proof on Insulation	IEC 60115-1 4.7	in V-block for 60 Sec., test voltage by type	By type
Temperature Coefficient	IEC 60115-1 4.8	-55°C to +155°C	By type
Insulation Resistance	IEC 60115-1 4.6	in V-block for 60 Sec.	>1,000MΩ
Solderability	IEC 60115-1 4.17	235±5°C for 3±0.5 Sec.	95% Min. coverage
Solvent Resistance of Marking	IEC 60115-1 4.30	IPA for 5±0.5 Min. with ultrasonic	No deterioration of coatings and markings
Robustness of Terminations	IEC 60115-1 4.16	Direct load for 10 Sec. in the direction of the terminal leads	≥2.5kg (24.5N)
Periodic-pulse Overload	IEC 60115-1 4.39	4 times RCWV 10,000 cycles (1 Sec. on, 25 Sec. off)	±2.0%+0.05Ω
Damp Heat Steady State	IEC 60115-1 4.24	40±2°C, 90-95% RH for 56 days, loaded with 0.1 times RCWV	±5.0%+0.05Ω
Endurance at 70°C	IEC 60115-1 4.25	70±2°C at RCWV for 1,000 Hr. (1.5 Hr. on, 0.5 Hr. off)	±5.0%+0.05Ω
Temperature Cycling	IEC 60115-1 4.19	-55°C ⇄ Room Temp. ⇄ +155°C ⇄ Room Temp. (5 cycles)	±2.0%+0.05Ω
Resistance to Soldering Heat	IEC 60115-1 4.18	260±3°C for 10±1 Sec., immersed to a point 3±0.5mm from the body	±1.0%+0.05Ω

Note: Rated Continuous Working Voltage (RCWV) = $\sqrt{\text{Power Rating} \times \text{Resistance Value}}$ or Max. working voltage listed above, whichever less.

Revision: 201304

Cement Resistors

Vertical Lead Type

Normal Style [SQM Series]

Non-Inductive Style [NSM Series]



INTRODUCTION

The SQM Series are ceramic housed resistors with fiberglass based wirewound or ceramic rod wirewound or metal oxide core. The NSM Series are ceramic housed low-inductive resistors with ceramic rod wirewound core.

The materials used and the construction techniques ensure excellent flame resistance, arc resistance and moisture resistance as well as self-extinguishing capabilities. They will withstand the most rigorous loading test.

As resistors in radio and television receivers, hazardous conditions such as smoking and redheat can be completely prevented by the proper choice of power resistors.

FEATURES

Power Rating	2W, 3W, 5W, 7W, 10W
Resistance Tolerance	±5%
T.C.R.	±250ppm/°C, -80~500ppm/°C (depends on value)

DERATING CURVE

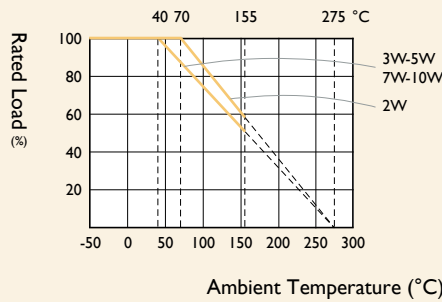

TEMPERATURE RISE

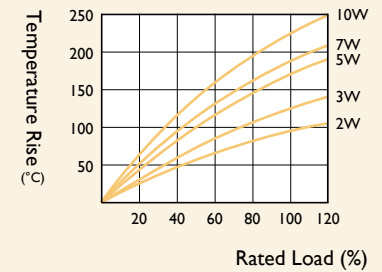

DIMENSIONS

Unit: mm

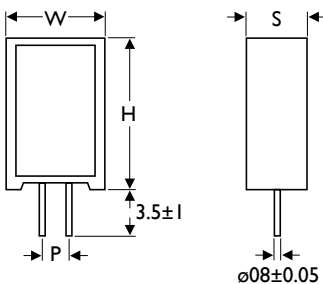

STYLE		DIMENSION			
Normal	Non-Ind.	H	W	S	P
SQM200	NSM200	20±1.5	11.0±1.0	7.0±1.0	5 ⁺²⁻¹
SQM300	NSM300	25±1.5	12.0±1.0	8.0±1.0	5 ⁺²⁻¹
SQM500	NSM500	25±1.5	13.0±1.0	9.0±1.0	5 ⁺²⁻¹
SQM700	NSM700	39±1.5	13.0±1.0	9.0±1.0	5 ⁺²⁻¹
SQM10A	NSM10A	51±1.5	13.0±1.0	9.0±1.0	5 ⁺²⁻¹
SQM10S	NSM10S	35±1.5	16.0±1.0	12.0±1.0	7 ⁺²⁻¹

ELECTRICAL CHARACTERISTICS

NORMAL STYLE

STYLE	SQM200	SQM300	SQM500	SQM700	SQM10A	SQM10S
Power Rating at 40°C		3W	5W	7W	10W	
Power Rating at 70°C	2W					
Maximum Working Voltage	250V	350V		500V		
Maximum Overload Voltage	500V	700V		1,000V		
Voltage Proof on Insulation	500V	700V		1,000V		
Resistance Range (Ceramic based wirewound)	0.1Ω - 36Ω	0.1Ω - 68Ω	0.1Ω - 130Ω	0.1Ω - 330Ω	0.1Ω - 510Ω	0.1Ω - 270Ω
Resistance Range (Metal Oxide Film)	39Ω - 1MΩ	75Ω - 1MΩ	150Ω - 1MΩ	360Ω - 1MΩ	560Ω - 1MΩ	300Ω - 1MΩ
Resistance Range (Fiberglass based wirewound)	0.1Ω - 1KΩ	0.1Ω - 4.7KΩ		0.1Ω - 10KΩ	0.1Ω - 16KΩ	0.1Ω - 4.7KΩ
Operating Temp. Range	-55°C to +155°C					
Temperature Coefficient	±300ppm/°C					

NON-INDUCTIVE STYLE

STYLE	NSM200	NSM300	NSM500	NSM700	NSM10A	NSM10S
Power Rating at 40°C		3W	5W	7W	10W	
Power Rating at 70°C	2W					
Maximum Working Voltage	$\sqrt{P \times R}$					
Voltage Proof on Insulation	500V	700V		1,000V		
Resistance Range (Ceramic based wirewound)	0.1Ω - 10Ω	0.1Ω - 30Ω	0.15Ω - 65Ω	0.27Ω - 100Ω		
Operating Temp. Range	-55°C to +155°C					
Temperature Coefficient	±300ppm/°C					

Note: Special value is available on request

ENVIRONMENTAL CHARACTERISTICS

PERFORMANCE TEST	TEST METHOD		APPRAISE
Short Time Overload	IEC 60115-1 4.13	2.5 times RCWV for 5 Sec.	±2.0%+0.05Ω
Voltage Proof on Insulation	IEC 60115-1 4.7	in V-block for 60 Sec., test voltage by type	By type
Temperature Coefficient	IEC 60115-1 4.8	-55°C to +155°C	By type
Insulation Resistance	IEC 60115-1 4.6	in V-block for 60 Sec.	>1,000MΩ
Solderability	IEC 60115-1 4.17	235±5°C for 3±0.5 Sec.	95% Min. coverage
Solvent Resistance of Marking	IEC 60115-1 4.30	IPA for 5±0.5 Min. with ultrasonic	No deterioration of coatings and markings
Robustness of Terminations	IEC 60115-1 4.16	Direct load for 10 Sec. in the direction of the terminal leads	≥2.5kg (24.5N)
Periodic-pulse Overload	IEC 60115-1 4.39	4 times RCWV 10,000 cycles (1 Sec. on, 25 Sec. off)	±2.0%+0.05Ω
Damp Heat Steady State	IEC 60115-1 4.24	40±2°C, 90-95% RH for 56 days, loaded with 0.1 times RCWV	±5.0%+0.05Ω
Endurance at 70°C	IEC 60115-1 4.25	70±2°C at RCWV for 1,000 Hr. (1.5 Hr. on, 0.5 Hr. off)	±5.0%+0.05Ω
Temperature Cycling	IEC 60115-1 4.19	-55°C ⇌ Room Temp. ⇌ +155°C ⇌ Room Temp. (5 cycles)	±2.0%+0.05Ω
Resistance to Soldering Heat	IEC 60115-1 4.18	260±3°C for 10±1 Sec., immersed to a point 3±0.5mm from the body	±1.0%+0.05Ω

Note: Rated Continuous Working Voltage (RCWV) = $\sqrt{\text{Power Rating} \times \text{Resistance Value}}$ or Max. working voltage listed above, whichever less.

Cement Resistors

Radial Terminal Type

Normal Style [SQZ Series]

Non-Inductive Style [NSZ Series]

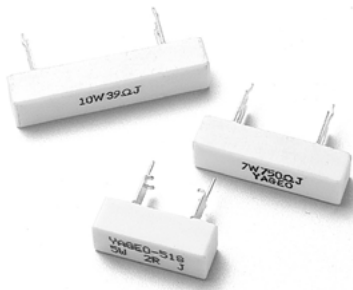

INTRODUCTION

The materials used and the construction techniques ensure excellent flame resistance, arc resistance and moisture resistance as well as self-extinguishing capabilities. They will withstand the most rigorous loading test.

As resistors in radio and television receivers, hazardous conditions such as smoking and redheat can be completely prevented by the proper choice of power resistors.

FEATURES

Power Rating	5W, 7W, 10W, 15W, 20W
Resistance Tolerance	±5%
T.C.R.	±300ppm/°C

DERATING CURVE

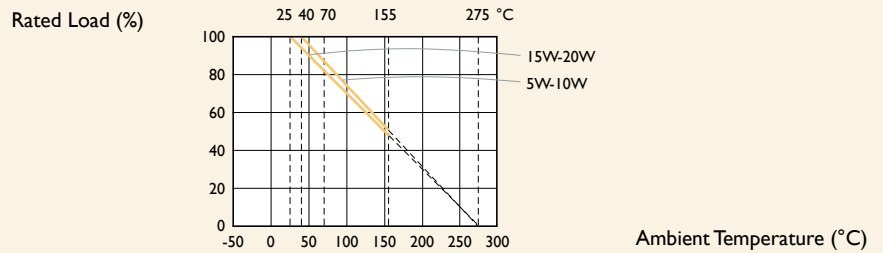

TEMPERATURE RISE

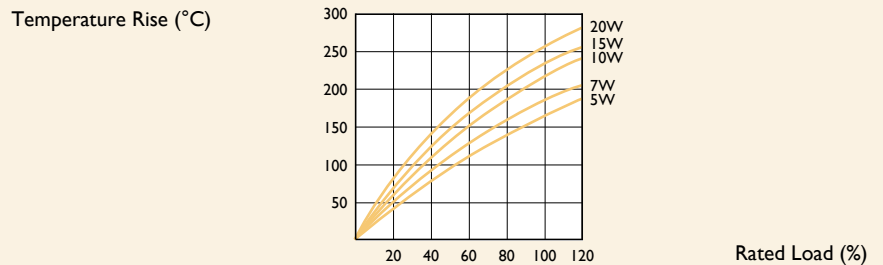

DIMENSIONS

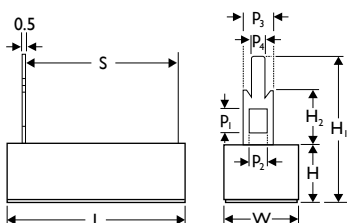

STYLE	DIMENSION	Unit: mm											
		Normal	Non-Ind.	L	H	W	S	H ₁	H ₂	P ₁	P ₂	P ₃	P ₄
SQZ500	NSZ500			28.0±1.5	10.0±1.0	10.0±1.0	15.0±1.5	25.0±1.5	10.0±1.0	4.0±0.2	2.0±0.2	5.0±0.2	1.5±0.2
SQZ700	NSZ700			35.0±1.5	10.0±1.0	10.0±1.0	22.5±1.5	25.0±1.5	10.0±1.0	4.0±0.2	4.0±0.2	5.0±0.2	1.5±0.2
SQZ10A	NSZ10A			48.0±1.5	9.5±1.0	10.0±1.0	32.0±1.5	25.0±1.5	10.5±1.0	4.0±0.2	4.0±0.2	5.0±0.2	1.5±0.2
SQZ15A	NSZ15A			48.0±1.5	12.5±1.0	13.0±1.0	32.0±1.5	35.0±1.5	15.0±1.5	7.0±0.2	4.0±0.2	10.0±0.2	3.0±0.2
SQZ20A	NSZ20A			63.0±1.5	12.5±1.0	12.5±1.0	42.5±1.5	35.0±1.5	15.0±1.5	7.0±0.2	4.0±0.2	10.0±0.2	3.0±0.2

ELECTRICAL CHARACTERISTICS

NORMAL STYLE

STYLE	SQZ500	SQZ700	SQZ10A	SQZ15A	SQZ20A
Power Rating at 25°C				15W	20W
Power Rating at 40°C	5W	7W	10W		
Maximum Working Voltage	350V	500V			
Maximum Overload Voltage	700V	1,000V			
Voltage Proof on Insulation	700V	1,000V			
Resistance Range (Wirewound)	0.36Ω - 200Ω		0.56Ω - 430Ω	1Ω - 560Ω	1.5Ω - 750Ω
Resistance Range (Metal Oxide Film)	220Ω - 1MΩ	300Ω - 1MΩ	470Ω - 1MΩ	750Ω - 1MΩ	820Ω - 1MΩ
Operating Temp. Range	-55°C to +155°C				
Temperature Coefficient	±300ppm/°C				

NON-INDUCTIVE STYLE

STYLE	NSZ500	NSZ700	NSZ10A	NSZ15A	NSZ20A
Power Rating at 25°C				15W	20W
Power Rating at 40°C	5W	7W	10W		
Maximum Working Voltage	$\sqrt{P \times R}$				
Voltage Proof on Insulation	700V	1,000V			
Resistance Range (Wirewound)	0.1Ω - 10Ω		0.1Ω - 20Ω		0.1Ω - 30Ω
Operating Temp. Range	-55°C to +155°C				
Temperature Coefficient	±300ppm/°C				

Note: Special value is available on request

ENVIRONMENTAL CHARACTERISTICS

PERFORMANCE TEST	TEST METHOD		APPRAISE
Short Time Overload	IEC 60115-1 4.13	2.5 times RCWV for 5 Sec.	±2.0%+0.05Ω
Voltage Proof on Insulation	IEC 60115-1 4.7	in V-block for 60 Sec., test voltage by type	By type
Temperature Coefficient	IEC 60115-1 4.8	-55°C to +155°C	By type
Insulation Resistance	IEC 60115-1 4.6	in V-block for 60 Sec.	>1,000MΩ
Solderability	IEC 60115-1 4.17	235±5°C for 3±0.5 Sec.	95% Min. coverage
Solvent Resistance of Marking	IEC 60115-1 4.30	IPA for 5±0.5 Min. with ultrasonic	No deterioration of coatings and markings
Periodic-pulse Overload	IEC 60115-1 4.39	4 times RCWV 10,000 cycles (1 Sec. on, 25 Sec. off)	±2.0%+0.05Ω
Damp Heat Steady State	IEC 60115-1 4.24	40±2°C, 90-95% RH for 56 days, loaded with 0.1 times RCWV	±5.0%+0.05Ω
Endurance at 70°C	IEC 60115-1 4.25	70±2°C at RCWV for 1,000 Hr. (1.5 Hr. on, 0.5 Hr. off)	±5.0%+0.05Ω
Temperature Cycling	IEC 60115-1 4.19	-55°C ⇄ Room Temp. ⇄ +155°C ⇄ Room Temp. (5 cycles)	±2.0%+0.05Ω
Resistance to Soldering Heat	IEC 60115-1 4.18	260±3°C for 10±1 Sec., immersed to a point 3±0.5mm from the body	±1.0%+0.05Ω

Note: Rated Continuous Working Voltage (RCWV) = $\sqrt{\text{Power Rating} \times \text{Resistance Value}}$ or Max. working voltage listed above, whichever less.

Revision: 201304

Fiberglass Cement Resistors

Power Wirewound & Axial Lead Type

Normal & Miniature Style [PSP Series]

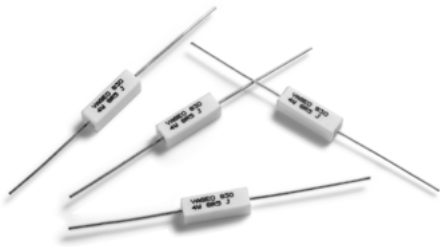

INTRODUCTION

The PSP Series Resistors are wound on Fiberglass core. The materials used and the construction techniques ensure excellent flame resistance, arc resistance and moisture resistance as well as self-extinguishing capabilities. They will withstand the most rigorous loading test.

As resistors in radio and television receivers, hazardous conditions such as smoking and redheat can be completely prevented by the proper choice of power resistors.

FEATURES

Power Rating	4W, 5W, 7W, 9W, 11W, 17W
Resistance Tolerance	±5%, ±10%
T.C.R	±10ppm/°C, ±40ppm/°C, 400±50ppm/°C

DERATING CURVE

For resistors operated in ambient temperatures above 70°C, power rating must be derated in accordance with the curve below.

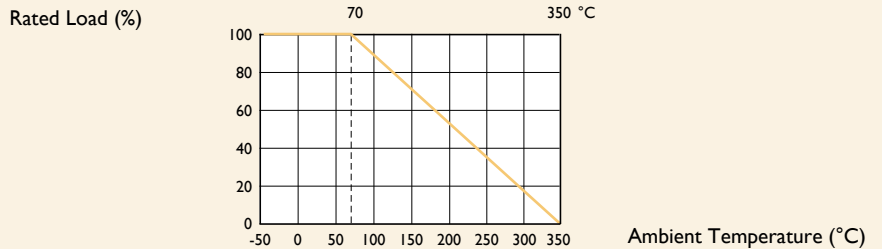

DIMENSIONS

Unit: mm

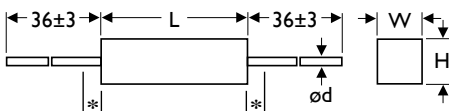

* 6mm, reduced solderability in this area

STYLE		DIMENSION			
Normal	Miniature	L	W	H	ød
PSP400	-	20±1.0	6.4±0.3	6.4±0.3	0.8±0.02
PSP500	-	25±1.0	6.4±0.3	6.4±0.3	0.8±0.02
-	PSP7WS	25±1.0	9.0±0.3	9.0±0.3	0.8±0.02
PSP700	-	38±1.0	6.4±0.3	6.4±0.3	0.8±0.02
PSP900	-	38±1.0	9.0±0.3	9.0±0.3	0.8±0.02
PSP11A	-	50±1.5	9.0±0.3	9.0±0.3	0.8±0.02
PSP17A	-	75±2.0	9.0±0.3	9.0±0.3	0.8±0.02

Note:

ELECTRICAL CHARACTERISTICS

STYLE	PSP400	PSP500	PSP7WS	PSP700	PSP900	PSP11A	PSP17A
Power Rating at 70°C	4W	5W	7W		9W	11W	17W
Maximum working voltage	$\sqrt{P \times R}$						
Voltage Proof on Insulation	2000V						
Resistance Range	0.1 Ω - 9.1K Ω	0.15 Ω - 15K Ω		0.33 Ω - 33K Ω		0.51 Ω - 47K Ω	0.91 Ω - 82K Ω
Operating Temp. Range	-55°C to +350°C						
Temperature Coefficient	± 10 ppm/°C, ± 40 ppm/°C, 400 ± 50 ppm/°C						

Note: Special value is available on request

ENVIRONMENTAL CHARACTERISTICS

PERFORMANCE TEST	TEST METHOD		APPRAISE
Short Time Overload	IEC 60115-1 4.13	10 times rated power for 5 Sec.	$\pm 2.0\% + 0.05\Omega$
Voltage Proof on Insulation	IEC 60115-1 4.7	in V-block for 60 Sec., test voltage by type	By type
Temperature Coefficient	IEC 60115-1 4.8	-55°C to +155°C	By type
Insulation Resistance	IEC 60115-1 4.6	in V-block for 60 Sec.	>10,000M Ω
Solderability	IEC 60115-1 4.17	235 ± 5 °C for 3 ± 0.5 Sec.	95% Min. coverage
Solvent Resistance of Marking	IEC 60115-1 4.30	IPA for 5 ± 0.5 Min. with ultrasonic	No deterioration of coatings and markings
Robustness of Terminations	IEC 60115-1 4.16	Direct load for 10 Sec. in the direction of the terminal leads	≥ 50 N
Periodic-pulse Overload	IEC 60115-1 4.39	4 times RCWV 10,000 cycles (1 Sec. on, 25 Sec. off)	$\pm 2.0\% + 0.05\Omega$
Damp Heat Steady State	IEC 60115-1 4.24	40 ± 2 °C, 90-95% RH for 56 days, loaded with 0.1 times RCWV	$\pm 2.0\% + 0.05\Omega$
Endurance at 70°C	IEC 60115-1 4.25	70 ± 2 °C at RCWV for 1,000 Hr: (1.5 Hr. on, 0.5 Hr. off)	$\pm 3.0\% + 0.05\Omega$
Temperature Cycling	IEC 60115-1 4.19	-55°C \Rightarrow Room Temp. \Rightarrow +155°C \Rightarrow Room Temp. (5 cycles)	$\pm 2.0\% + 0.05\Omega$
Resistance to Soldering Heat	IEC 60115-1 4.18	260 ± 3 °C for 10 ± 1 Sec., immersed to a point 3 ± 0.5 mm from the body	$\pm 0.2\% + 0.05\Omega$

Note: RCWV(Rated Continuous Working Voltage) = $\sqrt{\text{Power Rating} \times \text{Resistance Value}}$ or Max. working voltage listed above, whichever less.

Fiberglass Cement Resistors

Power Wirewound & Vertical Lead Type

Normal & Miniature Style [PSM Series]



INTRODUCTION

The PSM Series Resistors are wound on Fiberglass core. The materials used and the construction techniques ensure excellent flame resistance, arc resistance and moisture resistance as well as self-extinguishing capabilities. They will withstand the most rigorous loading test.

As resistors in radio and television receivers, hazardous conditions such as smoking and redheat can be completely prevented by the proper choice of power resistors.

FEATURES

Power Rating	4W, 5W, 7W, 9W, 11W, 17W
Resistance Tolerance	±5%, ±10%
T.C.R	±10ppm/°C, ±40ppm/°C, 400±50ppm/°C

DERATING CURVE

For resistors operated in ambient temperatures above 70°C, power rating must be derated in accordance with the curve below.

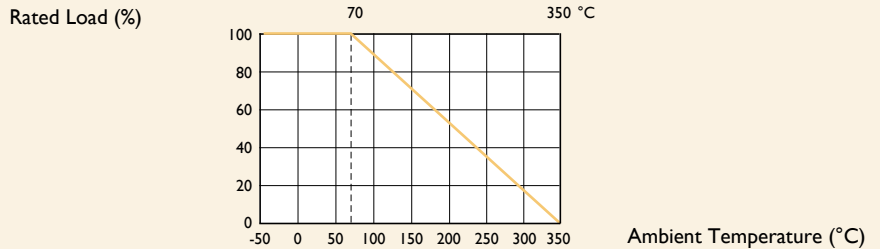

DIMENSIONS

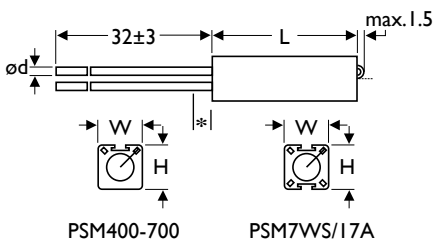

* 6mm, reduced solderability in this area

Unit: mm

STYLE		DIMENSION			
Normal	Miniature	L	W	H	ød
PSM400	-	20±1.0	7.0±0.5	8.0±0.4	0.8±0.02
PSM500	-	25±1.0	7.0±0.5	8.0±0.4	0.8±0.02
-	PSM7WS	25±1.0	9.0±0.4	10.0±0.4	0.8±0.02
PSM700	-	38±1.0	7.0±0.5	8.0±0.4	0.8±0.02
PSM900	-	38±1.0	9.0±0.4	10.0±0.4	0.8±0.02
PSM11A	-	50±1.5	9.0±0.4	10.0±0.4	0.8±0.02
PSM17A	-	75±2.0	9.0±0.4	10.0±0.4	0.8±0.02

Note:

ELECTRICAL CHARACTERISTICS

STYLE	PSM400	PSM500	PSM7WS	PSM700	PSM900	PSMI1A	PSMI7A
Power Rating at 70°C	4W	5W	7W		9W	11W	17W
Maximum working voltage	$\sqrt{P \times R}$						
Voltage Proof on Insulation	2000V						
Resistance Range	0.1Ω - 9.1KΩ	0.15Ω - 15KΩ		0.33Ω - 33KΩ		0.51Ω - 47KΩ	0.91Ω - 82KΩ
Operating Temp. Range	-55°C to +350°C						
Temperature Coefficient	±10ppm/°C, ±40ppm/°C, 400±50ppm/°C						

Note: Special value is available on request

ENVIRONMENTAL CHARACTERISTICS

PERFORMANCE TEST	TEST METHOD		APPRAISE
Short Time Overload	IEC 60115-1 4.13	10 times rated power for 5 Sec.	±2.0%+0.05Ω
Voltage Proof on Insulation	IEC 60115-1 4.7	in V-block for 60 Sec., test voltage by type	By type
Temperature Coefficient	IEC 60115-1 4.8	-55°C to +155°C	By type
Insulation Resistance	IEC 60115-1 4.6	in V-block for 60 Sec.	>10,000MΩ
Solderability	IEC 60115-1 4.17	235±5°C for 3±0.5 Sec.	95% Min. coverage
Solvent Resistance of Marking	IEC 60115-1 4.30	IPA for 5±0.5 Min. with ultrasonic	No deterioration of coatings and markings
Robustness of Terminations	IEC 60115-1 4.16	Direct load for 10 Sec. in the direction of the terminal leads	≥50N
Periodic-pulse Overload	IEC 60115-1 4.39	4 times RCWV 10,000 cycles (1 Sec. on, 25 Sec. off)	±2.0%+0.05Ω
Damp Heat Steady State	IEC 60115-1 4.24	40±2°C, 90-95% RH for 56 days, loaded with 0.1 times RCWV	±2.0%+0.05Ω
Endurance at 70°C	IEC 60115-1 4.25	70±2°C at RCWV for 1,000 Hr. (1.5 Hr. on, 0.5 Hr. off)	±3.0%+0.05Ω
Temperature Cycling	IEC 60115-1 4.19	-55°C ⇌ Room Temp. ⇌ +155°C ⇌ Room Temp. (5 cycles)	±2.0%+0.05Ω
Resistance to Soldering Heat	IEC 60115-1 4.18	260±3°C for 10±1 Sec., immersed to a point 3±0.5mm from the body	±2.0%+0.05Ω

Note: RCWV(Rated Continuous Working Voltage) = $\sqrt{\text{Power Rating} \times \text{Resistance Value}}$ or Max. working voltage listed above, whichever less.

Fiberglass Cement Resistors

Circuit Breaker & Axial Lead Type

Normal Style [FSP Series]

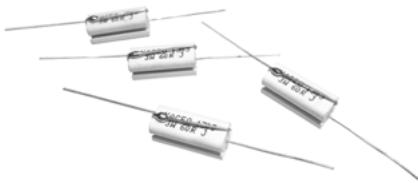

INTRODUCTION

The FSP Series Fiberglass Cement Resistors are wound on fibre glass core, have a special internal direct contact to virtually eliminate resistance changes caused by varying, often high temperatures. It offers a circuit-breaker function when overload is applied.

FEATURES

Power Rating	1.2W, 1.5W, 2W, 2.5W, 3W, 4W, 6W
Resistance Tolerance	±5%, ±10%
T.C.R.	-80~+500ppm/°C

DERATING CURVE

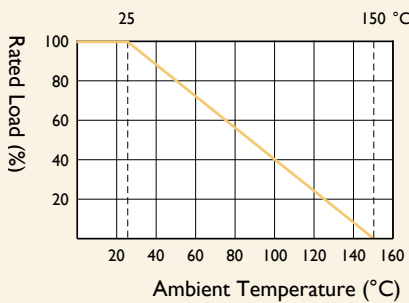

TEMPERATURE RISE

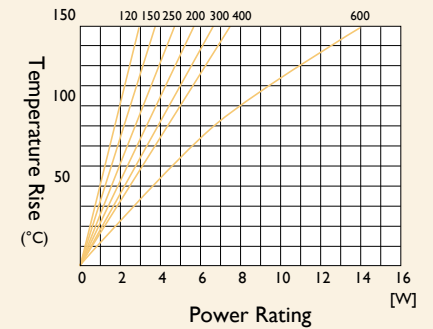

DIMENSIONS

Unit: mm

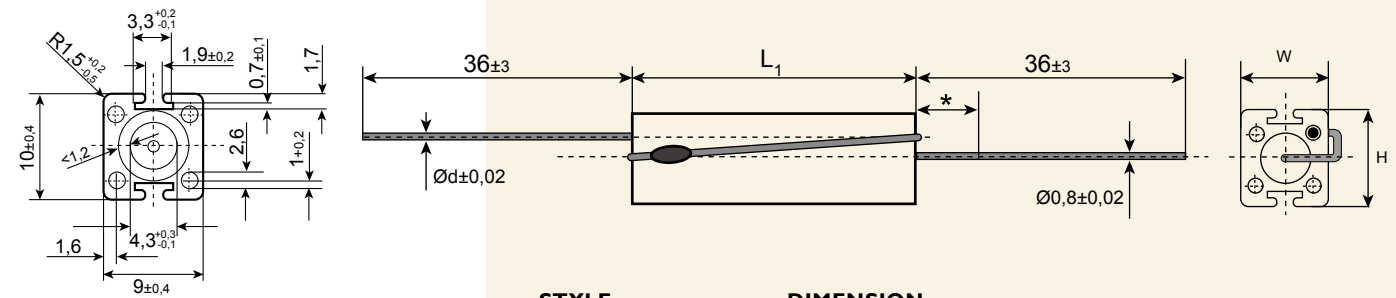

STYLE	DIMENSION			
	L	W	H	ød
Normal				
FSP120	20±1.0	7±0.5	8±0.3	0.6±0.02
FSP150	25±1.0	7±0.5	8±0.3	0.6±0.02
FSP250	38±1.0	7±0.5	8±0.3	0.8±0.02
FSP200	25±1.0	9±0.5	10±0.4	0.6±0.02
FSP300	38±1.0	9±0.5	10±0.4	0.8±0.02
FSP400	50±1.5	9±0.5	10±0.4	0.8±0.02
FSP600	75±2.0	9±0.5	10±0.4	0.8±0.02

Note:

ELECTRICAL CHARACTERISTICS

STYLE	FSP120	FSP150	FSP250	FSP200	FSP300	FSP400	FSP600
Power Rating at 25°C	2.5W	3W	4.5W	3.5W	5W	7W	11W
Power Rating at 70°C	1.2W	1.5W	2.5W	2W	3W	4W	6W
Maximum Working Voltage	$\sqrt{P \times R}$						
Voltage Proof on Insulation	2000V						
Resistance Range	0.1Ω-9.1KΩ	0.15Ω-15KΩ	0.33Ω-33KΩ	0.15Ω-15KΩ	0.33Ω-33KΩ	0.51Ω-47KΩ	0.91Ω-82KΩ
Operating Temp. Range	-55°C to +150°C						
Temperature Coefficient	-80~500ppm/°C						

Note: Special value is available on request

ENVIRONMENTAL CHARACTERISTICS

PERFORMANCE TEST	TEST METHOD		APPRAISE
Short Time Overload	IEC 60115-1 4.13	10 times rated power for 5 Sec.	±2.0%+0.05Ω
Voltage Proof on Insulation	IEC 60115-1 4.7	in V-block for 60 Sec., test voltage by type	By type
Temperature Coefficient	IEC 60115-1 4.8	-55°C to +150°C	By type
Insulation Resistance	IEC 60115-1 4.6	in V-block for 60 Sec.	>10,000M
Solderability	IEC 60115-1 4.17	235±5°C for 3±0.5 Sec.	95% Min. coverage
Solvent Resistance of Marking	IEC 60115-1 4.30	IPA for 5±0.5 Min. with ultrasonic	No deterioration of coatings and markings
Robustness of Terminations	IEC 60115-1 4.16	Direct load for 10 Sec. in the direction of the terminal leads	≥50N
Periodic-pulse Overload	IEC 60115-1 4.39	4 times RCWV 10,000 cycles (1 Sec. on, 25 Sec. off)	±2.0%+0.05Ω
Damp Heat Steady State	IEC 60115-1 4.24	40±2°C, 90-95% RH for 56 days, loaded with 0.1 times RCWV	±2.0%+0.05Ω
Endurance at 70°C	IEC 60115-1 4.25	70±2°C at RCWV for 1,000 Hr. (1.5 Hr. on, 0.5 Hr. off)	±3.0%+0.05Ω
Temperature Cycling	IEC 60115-1 4.19	-55°C ⇄ Room Temp. ⇄ +155°C ⇄ Room Temp. (5 cycles)	±2.0%+0.05Ω
Resistance to Soldering Heat	IEC 60115-1 4.18	260±3°C for 10±1 Sec., immersed to a point 3±0.5mm from the body	±0.2%+0.05Ω

Note: RCWV(Rated Continuous Working Voltage) = $\sqrt{\text{Power Rating} \times \text{Resistance Value}}$ or Max. working voltage listed above, whichever less.

Circuit Breaker & Vertical Lead Type

Normal Style [FSM Series]

Fiberglass Cement Resistors

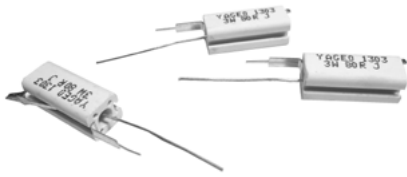

INTRODUCTION

The FSM Series Fiberglass Cement Resistors are wound on fibre glass core, have a special internal direct contact to virtually eliminate resistance changes caused by varying, often high temperatures. It offers a circuit-breaker function when overload is applied.

FEATURES

Power Rating	2W, 2.5W, 3.5W, 4.5W
Resistance Tolerance	±5%, ±10%
T.C.R.	-80~+500ppm/°C

DERATING CURVE

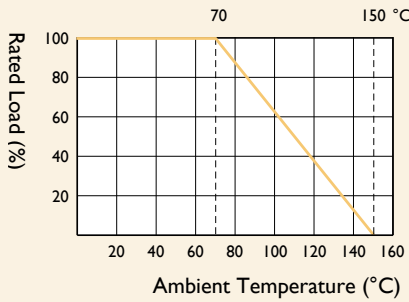

TEMPERATURE RISE

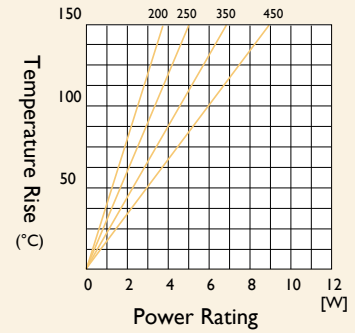

DIMENSIONS

Unit: mm

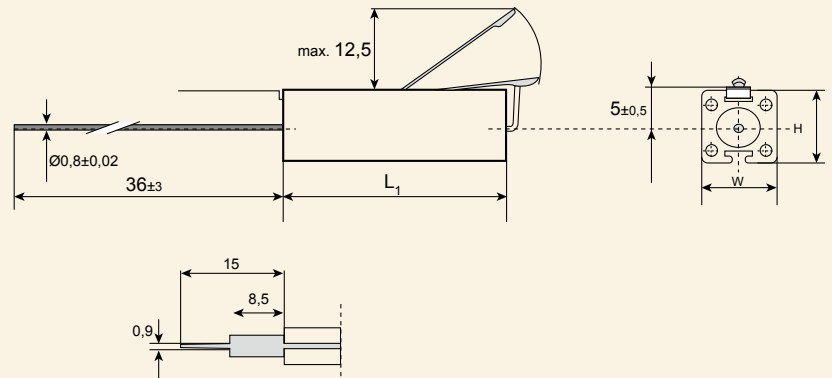
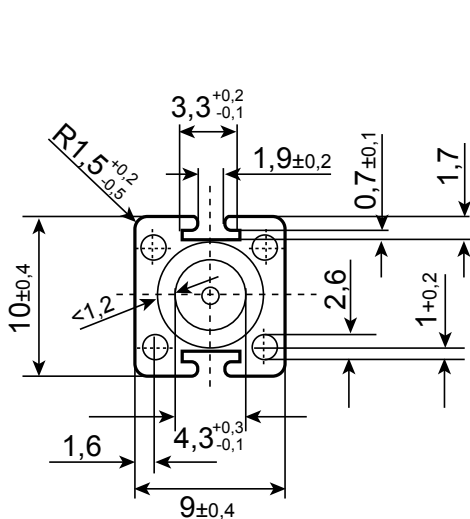

STYLE	DIMENSION		
	L ₁	W	H
Normal			
FSM200	25±1.0	9±0.4	10±0.4
FSM250	38±1.0	9±0.4	10±0.4
FSM350	50±1.0	9±0.4	10±0.4
FSM450	75±2.0	9±0.4	10±0.4

Note:

ELECTRICAL CHARACTERISTICS

STYLE	FSM200	FSM250	FSM350	FSM450
Power Rating at 70°C	2W	2.5W	3.5W	4.5W
Maximum Working Voltage	$\sqrt{P \times R}$			
Voltage Proof on Insulation	2000V			
Resistance Range	0.15Ω-15KΩ	0.33Ω-33KΩ	0.51Ω-47KΩ	0.91Ω-82KΩ
Operating Temp. Range	-55°C to +150°C			
Temperature Coefficient	-80~+500ppm/°C			

Note: Special value is available on request

ENVIRONMENTAL CHARACTERISTICS

PERFORMANCE TEST	TEST METHOD	APPRAISE
Short Time Overload	IEC 60115-1 4.13 10 times rated power for 5 Sec.	±2.0%+0.05Ω
Voltage Proof on Insulation	IEC 60115-1 4.7 in V-block for 60 Sec., test voltage by type	By type
Temperature Coefficient	IEC 60115-1 4.8 -55°C to +150°C	By type
Insulation Resistance	IEC 60115-1 4.6 in V-block for 60 Sec.	>10,000M
Solderability	IEC 60115-1 4.17 235±5°C for 3±0.5 Sec.	95% Min. coverage
Solvent Resistance of Marking	IEC 60115-1 4.30 IPA for 5±0.5 Min. with ultrasonic	"No deterioration of coatings and markings"
Robustness of Terminations	IEC 60115-1 4.16 Direct load for 10 Sec. in the direction of the terminal leads	≥50N
Periodic-pulse Overload	IEC 60115-1 4.39 4 times RCWV 10,000 cycles (1 Sec. on, 25 Sec. off)	±2.0%+0.05Ω
Damp Heat Steady State	IEC 60115-1 4.24 40±2°C, 90-95% RH for 56 days, loaded with 0.1 times RCWV	±2.0%+0.05Ω
Endurance at 70°C	IEC 60115-1 4.25 70±2°C at RCWV for 1,000 Hr. (1.5 Hr. on, 0.5 Hr. off)	±3.0%+0.05Ω
Temperature Cycling	IEC 60115-1 4.19 -55°C ⇌ Room Temp. ⇌ +155°C ⇌ Room Temp. (5 cycles)	±2.0%+0.05Ω
Resistance to Soldering Heat	IEC 60115-1 4.18 260±3°C for 10±1 Sec., immersed to a point 3±0.5mm from the body	±0.2%+0.05Ω

Note: RCWV(Rated Continuous Working Voltage) = $\sqrt{\text{Power Rating} \times \text{Resistance Value}}$ or Max. working voltage listed above, whichever less.

Cement Resistors

Fusible Thermal & Vertical Lead Type

Normal Style [FTR Series]

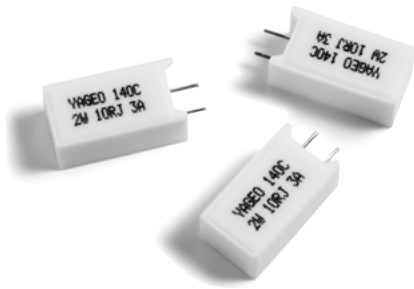

INTRODUCTION

The material used and the construction techniques ensure excellent flame resistance, arc resistance and moisture resistance as well as self-extinguishing capabilities. They will withstand the most rigorous loading test, also provide outstanding feature against surges, suitable for the prevention of inrush current for switching regulators.

FEATURES

Rated Current	2A, 3A, 5A, 10A
Resistance Tolerance	±5%, ±10%
T.C.R.	±250ppm/°C

DIMENSIONS

Unit: mm

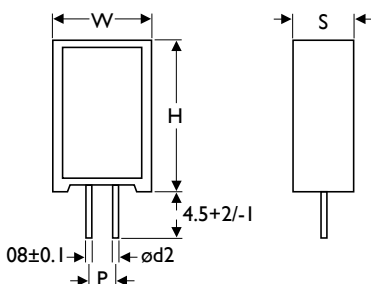

STYLE	DIMENSION				
	H	W	S	P	ød2
FTR100	25±1.5	13±1.0	9.0±1.0	5.0±1.0	0.6±0.1
FTR200	38±1.5	13±1.0	9.0±1.0	5.0±1.0	
FTR300	35±1.5	16±1.0	12±1.0	7.5±1.0	

Note:

ELECTRICAL CHARACTERISTICS

STYLE	STANDARD CURRENT (A)	FUSING TEMPERATURE (°C)	STANDARD VOLTAGE (V)	RESISTANCE RANGE	POWER RATING AT 70°C (W)		
					FTR100	FTR200	FTR300
FTR100 / 200 / 300	10A	109+1/-3	250	1Ω - 10KΩ	1.2	1.4	2.0
		129±4			1.6	2.0	2.5
		152±4			1.6	2.0	2.5
		188+3/-1			2.0	2.4	3.5
		226+1/-3			2.0	2.4	3.5
	5A	129±3			1.6	2.2	-
		187+1/-3			2.1	2.4	-
	3A	145±4			1.6	2.2	-
	2A	95+3/0			0.8	1.2	-
		110±4			1.2	1.4	-
		126±4			1.4	1.6	-
		130±4			1.6	2.1	-
		135±4			1.8	2.2	-
		145±4			2.1	2.4	-

Note: Special value is available on request

ENVIRONMENTAL CHARACTERISTICS

PERFORMANCE TEST	TEST METHOD		APPRAISE
Short Time Overload	IEC 60115-1 4.13	2.5 times RCWV for 5 Sec.	±2.0%+0.05Ω
Temperature Coefficient	IEC 60115-1 4.8	-25°C to +125°C	By type
Robustness of Terminations	IEC 60115-1 4.16	Direct load for 10 Sec. In the direction of the terminal leads	≥25N
Damp Heat Steady State	IEC 60115-1 4.24	40±2°C, 90-95% RH for 56 days, loaded with 0.1 times RCWV	±5.0%+0.1Ω

Note: RCWV(Rated Continuous Working Voltage) = $\sqrt{\text{Power Rating} \times \text{Resistance Value}}$ or Max. working voltage listed above, whichever less.

Cement Resistors

Low Ohmic Metal Plate Type Normal Style [SLR Series]

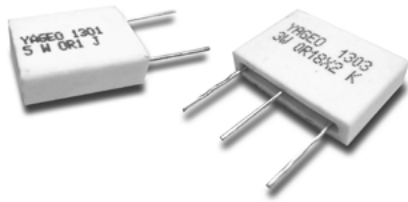

INTRODUCTION

The materials used and the construction techniques ensure excellent flame resistance, arc resistance and moisture resistance as well as self-extinguishing capabilities. They will withstand the most rigorous loading test.

As resistors in radio and television receivers, hazardous conditions such as smoking and redheat can be completely prevented by the proper choice of power resistors.

FEATURES

Power Rating	2W, 3W, 5W, 7W, 10W, 3W+3W, 5W+5W
Resistance Tolerance	±5%, ±10%
T.C.R.	±250ppm/°C

DERATING CURVE

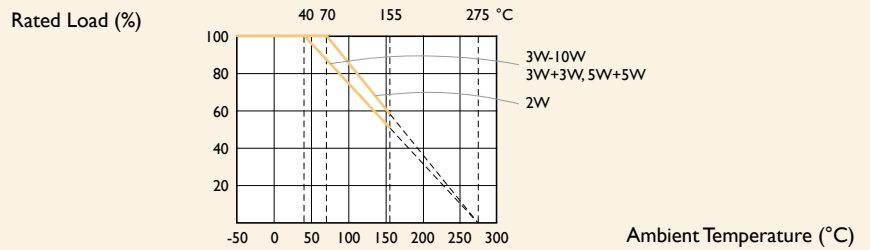

TEMPERATURE RISE

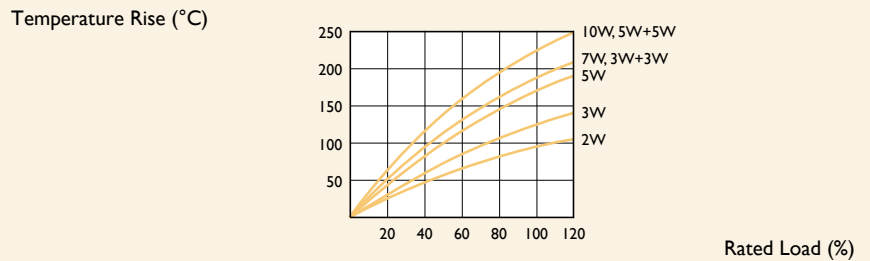

DIMENSIONS

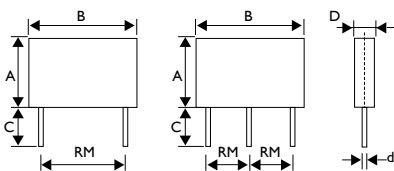

Unit: mm

STYLE	DIMENSION						
	Normal	A	B	C	D	ød	RM
SLR200		8±1	13±1	3.5±1	5±1	0.06±0.05	9±1
SLR300		13±1	13±1	3.5±1	5±1	0.06±0.05	9±1
SLR500		18±1	14±1	3.5±1	5±1	0.06±0.05	10±1
SLR700		18±1	26±1	3.5±1	5±1	0.08±0.05	20±1
SLR10A		20±1	26±1	3.5±1	5±1	0.08±0.05	20±1
SLR303		18±1	26±1	12±1	5±1	0.08±0.05	10±1
SLR505		20±1	26±1	12±1	5±1	0.08±0.05	10±1

Note:

ELECTRICAL CHARACTERISTICS

STYLE	SLR200	SLR300	SLR500	SLR700	SLR10A	SLR303	SLR505
Power Rating at 40°C		3W	5W	7W	10W	3W+3W	5W+5W
Power Rating at 70°C	2W						
Maximum Working Voltage	$\sqrt{P \times R}$						
Dielectric Withstanding Voltage	500V	700V		1,000V		700V	
Resistance range	0.10Ω - 0.68Ω	0.01Ω - 1Ω	0.01Ω - 3.3Ω			(0.1Ω+0.1Ω) - (0.5Ω+0.5Ω)	(0.1Ω+0.1Ω) - (1.8Ω+1.8Ω)
Operating Temp. Range	-55°C to +155°C						
Temperature Coefficient	±250ppm/°C						

Note: Special value is available on request

ENVIRONMENTAL CHARACTERISTICS

PERFORMANCE TEST	TEST METHOD		APPRAISE
Short Time Overload	IEC 60115-1 4.13	2.5 times RCWV for 5 Sec.	±2.0%+0.05Ω
Voltage Proof on Insulation	IEC 60115-1 4.7	in V-block for 60 Sec., test voltage by type	By type
Temperature Coefficient	IEC 60115-1 4.8	-55°C to +155°C	By type
Insulation Resistance	IEC 60115-1 4.6	in V-block for 60 Sec.	>1,000MΩ
Solderability	IEC 60115-1 4.17	235±5°C for 3±0.5 Sec.	95% Min. coverage
Solvent Resistance of Marking	IEC 60115-1 4.30	IPA for 5±0.5 Min. with ultrasonic	No deterioration of coatings and markings
Robustness of Terminations	IEC 60115-1 4.16	Direct load for 10 Sec. in the direction of the terminal leads	≥2.5kg (24.5N)
Periodic-pulse Overload	IEC 60115-1 4.39	4 times RCWV 10,000 cycles (1 Sec. on, 25 Sec. off)	±2.0%+0.05Ω
Damp Heat Steady State	IEC 60115-1 4.24	40±2°C, 90-95% RH for 56 days, loaded with 0.1 times RCWV	±5.0%+0.1Ω
Endurance at 70°C	IEC 60115-1 4.25	70±2°C at RCWV for 1,000 Hr. (1.5 Hr. on, 0.5 Hr. off)	±5.0%+0.1Ω
Temperature Cycling	IEC 60115-1 4.19	-55°C ⇌ Room Temp. ⇌ +155°C ⇌ Room Temp. (5 cycles)	±2.0%+0.05Ω
Resistance to Soldering Heat	IEC 60115-1 4.18	260±3°C for 10±1 Sec., immersed to a point 3±0.5mm from the body	±1.0%+0.05Ω

Note: RCWV(Rated Continuous Working Voltage) = $\sqrt{\text{Power Rating} \times \text{Resistance Value}}$ or Max. working voltage listed above, whichever less.

Aluminum Housed Resistors

Power Wirewound Type

Lug / Threaded Style [AHA Series]

Straight Leadwire Style [AHP Series]

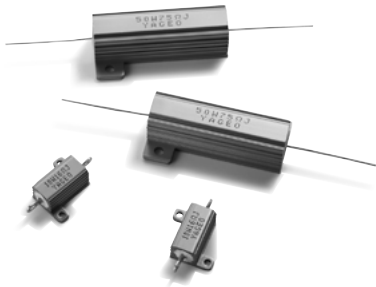

FEATURES

Power Rating	5W, 10W, 25W, 50W, 80W, 100W, 250W
Resistance Tolerance	±0.25%, ±0.5%, ±1%, ±5%, ±10%
T.C.R.	±50ppm/°C, ±100ppm/°C, ±200ppm/°C

DIMENSIONS

Unit: mm

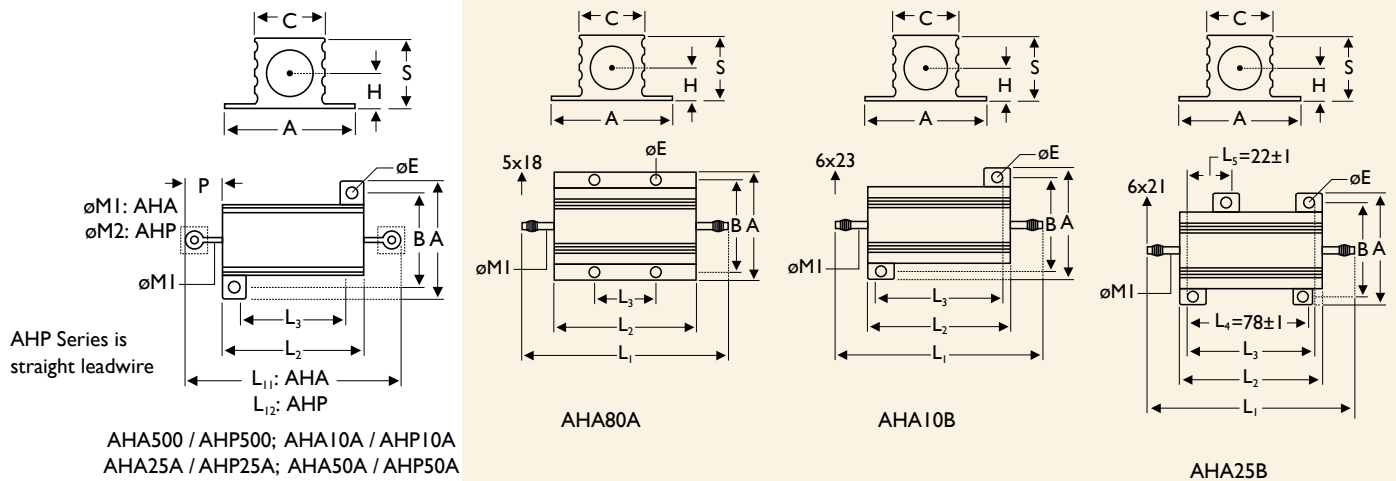

AHA500 / AHP500; AHA10A / AHP10A
 AHA25A / AHP25A; AHA50A / AHP50A

STYLE	DIMENSION													
	Normal	L11	L12	L2	L3	A	B	C	ØE	S	H	P	M1	M2
AHA500/AHP500		28.6±1.5	71.2±1.5	15.2±0.5	11.5±0.5	16.4±0.5	12.5±0.5	8.5±0.5	2.4±0.3	8.1±1.0	3.8±1.0	6.7±1.0	1.5±0.05	0.8±0.05
AHA10A/AHP10A		34.9±1.5	75.0±1.5	19.0±0.5	14.2±0.5	20.3±0.5	15.9±0.5	10.7±0.5	2.4±0.3	9.9±1.0	4.2±1.0	7.95±1.0	2.0±0.05	0.8±0.05
AHA25A/AHP25A		49.2±1.5	80.0±1.5	27.0±0.5	18.2±0.5	27.4±0.5	19.8±0.5	14.0±0.5	3.2±0.3	13.9±1.0	5.9±1.0	11.1±1.0	2.0±0.05	0.8±0.05
AHA50A/AHP50A		70.6±1.5	106±1.5	50.0±0.5	40.0±0.5	29.0±0.5	21.4±0.5	16.0±0.5	3.2±0.3	15.5±1.0	6.6±1.0	10.3±1.0	2.0±0.05	0.8±0.05
AHA80A		102±2.0	-	66.0±1.0	35.0±0.5	47.0±0.5	37.0±0.5	28.0±0.5	4.5±0.3	25.0±1.0	12.0±1.0	-	2.0±0.05	-
AHA10B		139±2.0	-	89.0±1.0	70.0±0.5	71.2±0.5	57.2±0.5	46.0±0.8	4.8±0.3	44.6±1.0	19.6±1.0	-	5.0±0.05	-
AHA25B		177±2.0	-	144.4±1.0	76.2±0.5	76.0±0.5	64.0±0.5	54.0±0.8	4.8±0.3	55.6±1.0	24.4±1.0	-	6.0±0.05	-

TEMPERATURE RISE

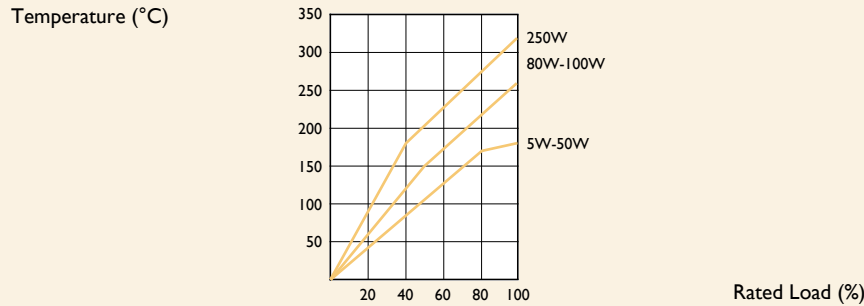

ELECTRICAL CHARACTERISTICS

STYLE	AHA500 AHP500	AHA10A AHP10A	AHA25A AHP25A	AHA50A AHP50A	AHA80A	AHA10B	AHA25B
Power Rating on std. heatsink at 25°C	5W	10W	25W	50W	80W	100W	250W
Voltage Proof on Insulation	1,000V			2,000V		4,500V	
Resistance Range	0.1Ω - 1KΩ	0.1Ω - 1.5KΩ	0.1Ω - 10KΩ	0.1Ω - 33KΩ	0.1Ω - 39KΩ	0.1Ω - 51KΩ	
Operating Temp. Range	-55°C to +250°C						
Temperature Coefficient	±50ppm/°C, ±100ppm/°C, ±200ppm/°C						

Note: Special value is available on request.

ENVIRONMENTAL CHARACTERISTICS

PERFORMANCE TEST	TEST METHOD		APPRAISE
Short Time Overload	IEC 60115-1 4.13	5 times of rated power for 5 sec.	±1.0%+0.05Ω
Voltage Proof on Insulation	IEC 60115-1 4.7	in V-block for 60 Sec., test voltage by type	By type
Temperature Coefficient	IEC 60115-1 4.8	-55°C to +250°C	By type
Insulation Resistance	IEC 60115-1 4.6	in V-block for 60 Sec.	>100MΩ
Solderability	IEC 60115-1 4.17	235±5°C for 3±0.5 Sec.	95% Min. coverage
Solvent Resistance of Marking	IEC 60115-1 4.30	IPA for 5±0.5 Min. with ultrasonic	No deterioration of coatings and markings
Robustness of Terminations	IEC 60115-1 4.16	Pull test (30 Sec. Min): 5W: 1kg, 10W: 2.3kg, 25 - 50W: 4.5kg Torque test (5 - 15 Sec): 80W: 2N, 100W: 2.7N, 250W: 3.7N	±0.2%+0.05Ω
Damp Heat Steady State	IEC 60115-1 4.24	40±2°C, 90-95% RH for 56 days, loaded with 0.1 times RCWV	±5.0%+0.05Ω
Endurance at 70°C	IEC 60115-1 4.25	70±2°C at RCWV for 1,000 Hr. (1.5 Hr. on, 0.5 Hr. off)	±5.0%+0.05Ω
Temperature Cycling	IEC 60115-1 4.19	-55°C ⇌ Room Temp. ⇌ +155°C ⇌ Room Temp. (5 cycles)	±1.0%+0.05Ω
Resistance to Soldering Heat	IEC 60115-1 4.18	260±3°C for 10±1 Sec., immersed to a point 3±0.5mm from the body	±1.0%+0.05Ω

Note: Rated Continuous Working Voltage (RCWV) = $\sqrt{\text{Power Rating} \times \text{Resistance Value}}$ or Max. working voltage listed above, whichever less.

Revision: 201304

High Power Wirewound Type

Threaded & 6 Mounting Holes Style [AHB Series]

Aluminum Housed Resistors



INTRODUCTION

The AHB Series Aluminum Housed Resistors have crust surface with good performance in heat radiation, suitable for cooling plate installation, can be used in the atrocious environment.

High insulating capacity, encapsulation by non-flame inorganic material, good performance in vibration.

FEATURES

Power Rating	75W, 100W, 150W, 200W, 250W, 300W, 500W
Resistance Tolerance	±1%, ±2%, ±5%, ±10%
T.C.R.	±25ppm/°C, ±50ppm/°C, ±100ppm/°C

DERATING CURVE

For resistors operated in ambient temperatures above 25°C, power rating must be derated in accordance with the curve below.

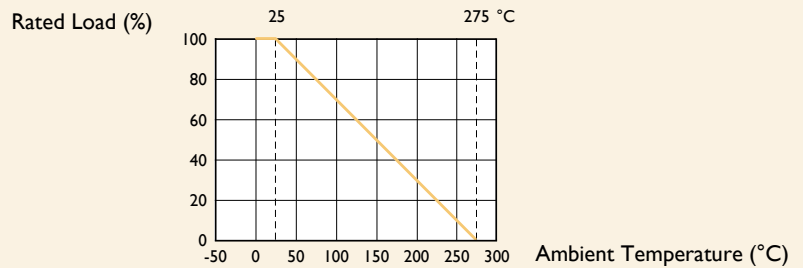

DIMENSIONS

Unit: mm

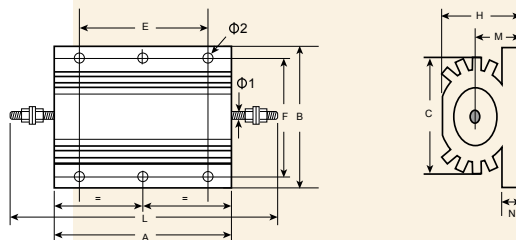

STYLE	DIMENSION										
	A	B	L	H	C	E	F	M	N	Ø1	Ø2
Normal											
AHB75A	65.5±2.0	48.0±2.0	93.5±3.0	26.0±1.0	27.0±1.5	47.0±2.0	37.0±1.5	11.5±1.5	3.5±0.5	4.0±0.5	4.4±0.5
AHB10B	98.0±2.0	48.0±2.0	126±3.0	26.0±1.0	27.0±1.5	70.0±2.0	37.0±1.5	11.5±1.5	3.5±0.5	4.0±0.5	4.4±0.5
AHB15B	130±2.0	48.0±2.0	158±3.0	26.0±1.0	27.0±1.5	104±2.0	37.0±1.5	11.5±1.5	3.5±0.5	4.0±0.5	4.4±0.5
AHB20B	92.0±2.0	73.0±2.0	132±3.0	45.0±1.0	46.5±1.5	70.0±2.0	58.0±1.5	21.0±1.5	5.0±0.5	6.0±0.5	5.5±0.5
AHB25B	112±2.0	73.0±2.0	152±3.0	45.0±1.0	46.5±1.5	90.0±2.0	58.0±1.5	21.0±1.5	5.0±0.5	6.0±0.5	5.5±0.5
AHB30B	130±2.0	73.0±2.0	170±3.0	45.0±1.0	46.5±1.5	102±2.0	58.0±1.5	21.0±1.5	5.0±0.5	6.0±0.5	5.5±0.5
AHB50B	204±2.0	73.0±2.0	244±3.0	45.0±1.0	46.5±1.5	174±2.0	58.0±1.5	21.0±1.5	5.0±0.5	6.0±0.5	5.5±0.5

Note:

ELECTRICAL CHARACTERISTICS

STYLE	AHB75A	AHB10B	AHB15B	AHB20B	AHB25B	AHB30B	AHB50B
Power Rating on std. heatsink at 25°C	75W	100W	150W	200W	250W	300W	500W
Power Rating without heatsink at 25°C	45W	50W	55W	50W	60W	75W	200W
Maximum Working Voltage (On std. heatsink)	1400V	1900V	2500V	1900V	2200V	2500V	
Voltage Proof on Insulation	4500V						
Resistance Range	0.1Ω - 39KΩ	0.1Ω - 51KΩ	0.1Ω - 56KΩ	0.1Ω - 62KΩ	0.1Ω - 68KΩ	0.1Ω - 75KΩ	0.1Ω - 82KΩ
Operating Temp. Range	-55°C to +275°C						
Temperature Coefficient	±25ppm/°C, ±50ppm/°C, ±100ppm/°C						

Note: Special value is available on request

ENVIRONMENTAL CHARACTERISTICS

PERFORMANCE TEST	TEST METHOD		APPRAISE
Short Time Overload	IEC 60115-1 4.13	5 times of rated power for 5 Sec.	±1.0%+0.05Ω
Voltage Proof on Insulation	IEC 60115-1 4.7	in V-block for 60 Sec., test voltage by type	By type
Temperature Coefficient	IEC 60115-1 4.8	-55°C to +275°C	By type
Insulation Resistance	IEC 60115-1 4.6	in V-block for 60 Sec.	>100M
Solderability	IEC 60115-1 4.17	235±5°C for 3±0.5 Sec.	95% Min. coverage
Solvent Resistance of Marking	IEC 60115-1 4.30	IPA for 5±0.5 Min. with ultrasonic	No deterioration of coatings and markings
Robustness of Terminations	IEC 60115-1 4.16	Direct load for 10 Sec. in the direction of the terminal leads	≥40N
Periodic-pulse Overload	IEC 60115-1 4.39	4 times RCWV 10,000 cycles (1 Sec. on, 25 Sec. off)	±1.0%+0.05Ω
Damp Heat Steady State	IEC 60115-1 4.24	40±2°C, 90-95% RH for 56 days, loaded with 0.1 times RCWV	±5.0%+0.05Ω
Endurance at 70°C	IEC 60115-1 4.25	70±2°C at RCWV for 1,000 Hr. (1.5 Hr. on, 0.5 Hr. off)	±5.0%+0.05Ω
Temperature Cycling	IEC 60115-1 4.19	-55°C ⇌ Room Temp. ⇌ +155°C ⇌ Room Temp. (5 cycles)	±1.0%+0.05Ω
Resistance to Soldering Heat	IEC 60115-1 4.18	260±3°C for 10±1 Sec., immersed to a point 3±0.5mm from the body	±1.0%+0.05Ω

Note: RCWV(Rated Continuous Working Voltage) = $\sqrt{\text{Power Rating} \times \text{Resistance Value}}$ or Max. working voltage listed above, whichever less.

Revision: 201304

GENERAL INFORMATION**PACKING METHODS**

The resistors are supplied on bandolier; either 1,000 resistors in ammpack or 5,000 resistors on reel.

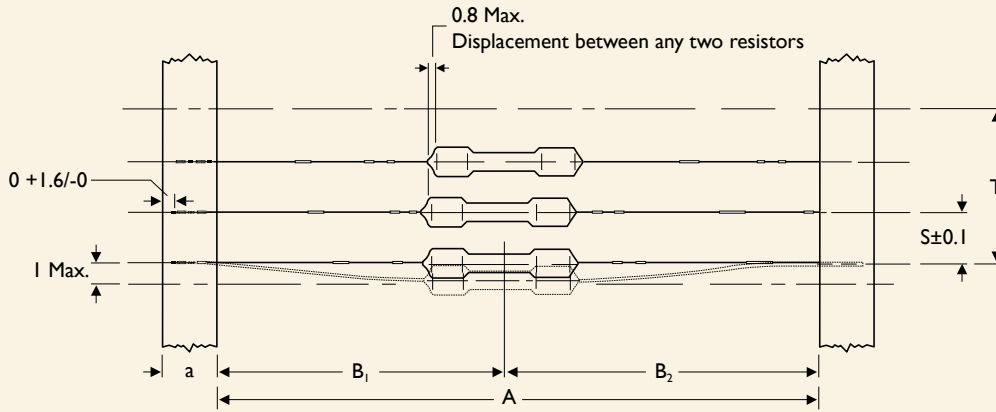

Bandolier for Axial Leads

STYLE		DIMENSIONS					Unit: mm
Normal	Miniature	a	A ⁽¹⁾	B ₁ - B ₂	S (Spacing)	T (Max. Deviation of Spacing)	
TYPE-12	TYPE25S / 204	6±0.5	52.4±1.5 26.0±1.5	1.2 1	5		
TYPE-25	TYPE50S / 207	6±0.5	52.4±1.5 26.0±1.5	1.2 1	5		
TYPE-50	TYPE1WS	6±0.5	52.4±1.5	1.2	5	1mm Per 10 Spacings, 0.5mm Per 5 Spacings	
TYPE100	TYPE2WS	6±0.5	73.0±1.5 52.4±1.5	1.5 1.2	5		
TYPE200	TYPE3WS	6±0.5	73.0±1.5	1.5	10		
KNP300	KNP5WS		52.4±1.5	1.2			
RSF300	RSF5WS	6±0.5	91.0±1.5	1.5	10		
RSF500 / KNP500	KNP7WS		73.0±1.5	1.5			

Note: 1. Optional please refer to table "Exception"

EXCEPTION

Unit: mm

SERIES	POWER RATING	STANDARD LEAD LENGTH	MINIATURE LEAD LENGTH
RSF	3WM, 5SS	73	52.4
KNP / NKN / FKN	3W, 4W, 5WS	73	52.4
RSF / KNP / NKN / FKN	5W, 7W on T/R	91	73

TAPE ON REEL PACKING

Bandoliers can be reeled; dimension a differ with type.

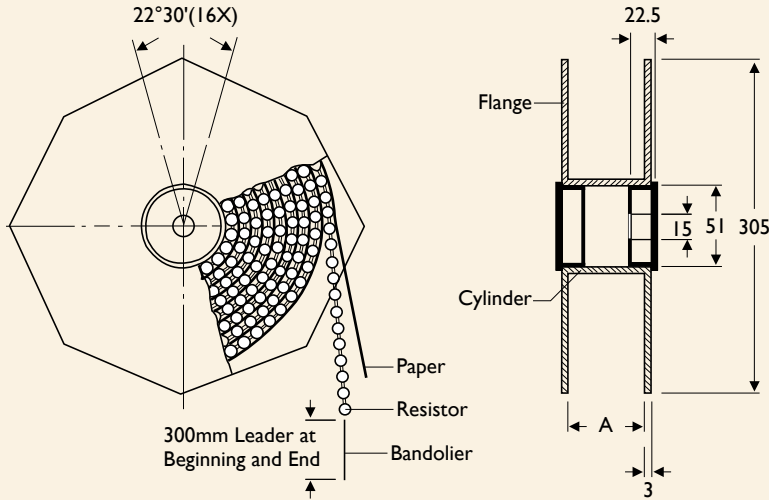

TAPE ON BOX PACKING

Bandoliers may also be supplied in a cardboard box ("ammopack").

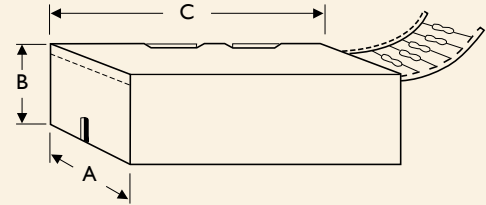

"Ammopack" is an abbreviation of "ammunition packing"
The dimensions of A-B-C vary with type and quantity.

STYLE		TAPE ON REEL		TAPE ON BOX			Unit: mm/pcs
Normal	Miniature	Across Flange (A)	Q'TY Per Reel	W (A)	H (B)	L (C)	Q'TY Per Box
TYPE-12	TYPE25S / 204	72	5,000	78/81	24/70	260	2,000/5,000
TYPE-25	TYPE50S / 207	48/72	5,000	78/81	24/104	260	1,000/5,000
TYPE-50	TYPE1WS	72	2,500	73	45	258	1,000
TYPE100	TYPE2WS	95	2,000	103	78	260	1,000
TYPE200	TYPE3WS	95	1,000	103	94	260	1,000
KNP300	KNP5WS	95	1,000	103	78	260	500
RSF300	RSF5WS	95	250	116	79	255	250
RSF500 / KNP500	KNP7WS						

BULK PACKING

POWER RATING	PCS/PER INNER BOX	BAG/PER INNER BOX	PCS/PER BAG
1/6W, 1/4WS, 0.4W	10,000	10	1,000
1/4W, 1/2WS, 0.6W	10,000	10	1,000
1/2W, 1WS	5,000	5	1,000
1W, 2WS	2,000	4	500
2W, 3WS	1,000	2	500
3W	1,000	2	500
5W	500	10	50
7W	500	10	50

PACKING QUANTITIES

TYPE	POWER	PACKAGE	Q'TY	WEIGHT	CARTON Q'TY	NW	GW	CARTON SIZE	CUBIC FIT
(Unit)	(Watt)		(Pcs)	(Kg)	(Pcs)	(Kg)	(Kg)	(cm)	(Cu.ft.)
Coating Type	1/6W	Tape / Reel	5,000	1.1	50,000	11	13	60×30.5×43.5	3
	1/4WS	Tape / Box	5,000	0.74	100,000	15	16	42.5×28×35	1.5
	0.4W	Bulk	10,000	1.18	160,000	19	20	42.5×28×35	1.5
	1/4W	Tape / Reel	5,000	1.5	50,000	16	18	60×30.5×43.5	3
	1/2WS	Tape / Box	5,000	1.1	75,000	18	19	42.5×28×35	1.5
	0.6W	Bulk	10,000	1.6	80,000	12	13	42.5×28×35	1.5
	1/2W	Tape / Reel	2,500	1.1	25,000	11	13	60×30.5×43.5	3
	1WS	Tape / Box	1,000	0.43	30,000	13	14	40.5×28×33	1.4
	1SS	Bulk	5,000	1.86	40,000	14	15	42.5×28×35	1.5
	1W	Tape / Reel	2,000	2.2	20,000	22	24	60×30.5×43.5	3
	2WS	Tape / Box	1,000	0.9	20,000	17	18	42.5×28×35	1.5
	2SS	Bulk	2,000	1.4	32,000	22	23	42.5×28×35	1.5
	2W	Tape / Reel	1,000	1.6	10,000	13	14	60×30.5×43.5	3
	3WS	Tape / Box	1,000	1.12	12,000	14	15	42.5×28×35	1.5
	3WV	Bulk	1,000	1.02	16,000	22	24	42.5×28×35	1.5
	3W	Tape / Reel	250	1.4	2,000	11	13	60×30.5×43.5	3
	5WS	Tape / Box	250	1.02	4,000	16	17	42.5×28×35	1.5
		Bulk	500	1.85	4,000	14	15	42.5×28×35	1.5
	5W, 7WS	Tape / Box	250	1	4,000	16	17	42.5×28×35	1.5
	5SS	Tape / Reel	1,000	2.5	8,000	21	23	60×30.5×43.5	3
3WM	Tape / Box	500	0.93	8,000	15	16	42.5×28×35	1.5	
	Bulk	1,000	1.7	16,000	27	28	42.5×28×35	1.5	
Jumper Wire	JPW-05	Tape / Reel	10,000	1.4	100,000	15	17	60×30.5×43.5	3
		Tape / Box	10,000	1.06	150,000	16	17	42.5×28×35	1.5
		Bulk	10,000	0.98	160,000	16	17	42.5×28×35	1.5
	JPW-06	Tape / Reel	10,000	1.9	100,000	22	24	60×30.5×43.5	3
		Tape / Box	10,000	1.5	150,000	24	25	42.5×28×35	1.5
		Bulk	10,000	1.4	160,000	23	24	42.5×28×35	1.5
	JPW-07	Tape / Reel	10,000	3	100,000	32	34	60×30.5×43.5	3
	JPW-08	Tape / Box	5,000	2.7	100,000	27	28	42.5×28×35	1.5
		Bulk	10,000	2.5	160,000	40	41	42.5×28×35	1.5
	JPW-10	Tape / Reel	10,000	5	100,000	50	52	60×30.5×43.5	3
Tape / Box		5,000	2.33	75,000	35	36	42.5×28×35	1.5	
Bulk		10,000	4.7	160,000	75	76	42.5×28×35	1.5	

PACKING QUANTITIES

SERIES	POWER	PACKAGE	Q'TY	WEIGHT	CARTON Q'TY	NW	GW	CARTON SIZE	CUBIC FIT
(Unit)	(Watt)		(Pcs)	(Kg)	(Pcs)	(Kg)	(Kg)	(cm)	(Cu.ft.)
SQP / NSP	2W	Bulk	1,400	5.3	2,800	10.6	11.5	42.5×28×35	1.5
	3W	Bulk	1,000	4.6	2,000	9	10	42.5×28×35	1.5
	5W	Bulk	900	4.8	1,800	10	10.5	42.5×28×35	1.5
	7W	Bulk	600	5.4	1,200	10.8	12	42.5×28×35	1.5
	10W	Bulk	500	5.8	1,000	12	13	42.5×28×35	1.5
	15W	Bulk	360	8.0	720	16	17	42.5×28×35	1.5
	20W	Bulk	50	1.4	800	22.4	24	42.5×28×35	1.5
	25W	Bulk	50	1.6	800	25.6	27.5	42.5×28×35	1.5
	30W	Bulk	50	3.3	800	52.8	55	42.5×28×35	1.5
	40W	Bulk	50	3.9	800	62.4	65	42.5×28×35	1.5
SQM / NSM	2W	Bulk	1,600	8.9	3,200	17.8	19	42.5×28×35	1.5
	3W	Bulk	1,400	8.5	2,800	17	18.5	42.5×28×35	1.5
	5W	Bulk	1,000	6.6	2,000	13	14	42.5×28×35	1.5
	7W	Bulk	700	7.1	1,400	14.2	15.5	42.5×28×35	1.5
	10W	Bulk	500	8.6	1,000	17.2	18.5	42.5×28×35	1.5
	10WS	Bulk	500	8.3	1,000	16.6	18	42.5×28×35	1.5
SQZ / NSZ	5W	Bulk	150	1.0	2,400	16	16.5	42.5×28×35	1.5
	7W	Bulk	150	1.6	2,400	24	25	42.5×28×35	1.5
	10W	Bulk	150	2.1	2,400	33	34	42.5×28×35	1.5
	15W	Bulk	50	1.1	800	17	18	42.5×28×35	1.5
	20W	Bulk	50	1.4	800	21	22	42.5×28×35	1.5
SLR	2W	Bulk	1,000	1.6	8,000	12	13	42.5×28×35	1.5
	3W	Bulk	1,000	2.2	8,000	17	18.3	42.5×28×35	1.5
	5W	Bulk	2,000	7.5	4,000	15	16	42.5×28×35	1.5

FORMING DIMENSION (SPECIAL TYPE)

M TYPE

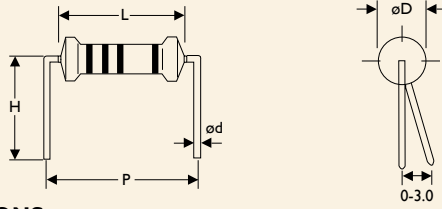

STYLE		DIMENSIONS					Unit: mm
Normal	Miniature	L	P	øD	ød	H	
TYPE-12	TYPE25S	3.4±0.3	6.0±1	1.9±0.2	0.45±0.05	10.0±1	
TYPE-25	TYPE50S	6.3±0.5	10.0±1	2.4±0.2	0.55±0.05	10.0±1	
TYPE-50	TYPE1WS	9.0±0.5	12.5±1	3.3±0.3	0.55±0.05	10.0±1	
TYPE100	TYPE2WS	11.5±1.0	15.0±1	4.5±0.5	0.8±0.05	12.5±1	
TYPE200	TYPE3WS	15.5±1.0	20.0±1	5.0±0.5	0.8±0.05	15.0±1	
TYPE300/TYPE400	TYPE5WS/TYPE5SS	17.5±1.0	25.0±1.0	6.5±0.5	0.8±0.05	15.0±1.0	
TYPE500/TYPE700	TYPE7WS	24.5±1.0	30.0±1.0	8.0±0.5	0.8±0.05	15.0±1.0	

Note: FMP/KNP/NKN/FKN/PNP/PNPV/FAE series: øD is different from above table, please refer to each specification of catalog.

MB TYPE

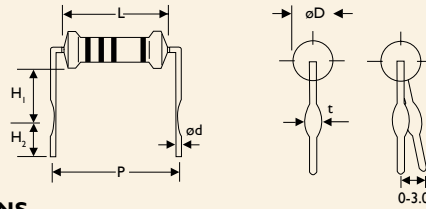

STYLE		DIMENSIONS							Unit: mm
Normal	Miniature	L	P	øD	ød	H ₁	H ₂	t	
TYPE-25	TYPE50S	6.3±0.5	10.0±1	2.4±0.2	0.55±0.05	6.0±1	5.0±1	1.2±0.2	
TYPE-50	-	9.0±0.5	12.5±1	3.3±0.3	0.55±0.05	6.0±1	5.0±1	1.2±0.2	
-	TYPE1WS	9.0±0.5	12.5±1	3.3±0.3	0.8±0.05	6.0±1	5.0±1	1.4±0.2	
TYPE100	TYPE2WS	11.5±1.0	15.0±1	4.5±0.5	0.8±0.05	6.0±1	5.0±1	1.4±0.2	
TYPE200	TYPE3WS	15.5±1.0	20.0±1	5.0±0.5	0.8±0.05	10.0±1	5.0±1	1.4±0.2	
TYPE300/TYPE400	TYPE5WS/TYPE5SS	17.5±1.0	25.0±1.0	6.5±0.5	0.8±0.05	10.0±1	5.0±1	1.4±0.2	
TYPE500/TYPE700	TYPE7WS	24.5±1.0	30.0±1	8.0±0.5	0.8±0.05	15.0±1	5.0±1	1.4±0.2	
RSF300/RSF500	RSF5WS	24.5±1.0	30.0±1	8.0±0.5	0.8±0.05	15.0±1	5.0±1	1.4±0.2	

Note: FMP/KNP/NKN/FKN/PNP/PNPV/FAE series: øD is different from above table, please refer to each specification of catalog.

MR TYPE

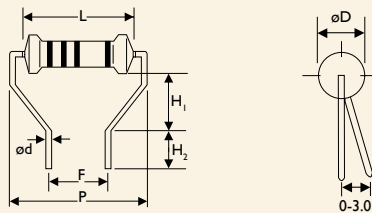

STYLE		DIMENSIONS						Unit: mm
Normal	Miniature	L	P	F	øD	ød	H ₁	H ₂
TYPE-50	TYPE1WS	9.0±0.5	14.5±1	7.0±0.5	3.3±0.3	0.55±0.05	7.0±1	5.0±1
TYPE100	TYPE2WS	11.5±1.0	17.5±1	7.0±0.5	4.5±0.5	0.8±0.05	8.0±1	5.0±1
TYPE200	TYPE3WS	15.5±1.0	21.5±1	7.0±0.5	5.0±0.5	0.8±0.05	9.0±1	5.0±1

Note: FMP/KNP/NKN/FKN/PNP/PNPV/FAE series: øD is different from above table, please refer to each specification of catalog.

F TYPE

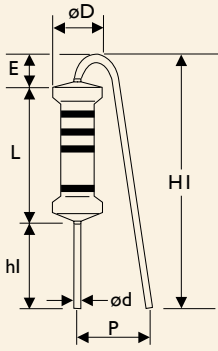

FK TYPE

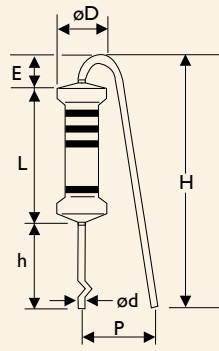

FFK TYPE

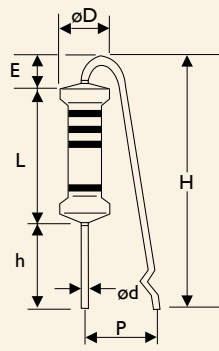

FKK TYPE

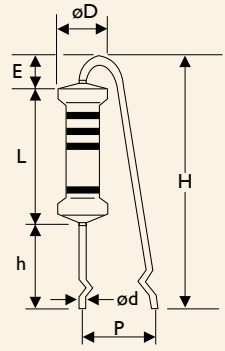

STYLE

DIMENSIONS

Unit: mm

Normal	Miniature	L	P	øD	ød	h	H Max.	hl	HI Max.	E Max.
TYPE-50	TYPE1WS	9.5±0.5	6±1	3.3±0.3	0.55±0.5	8.0±1	22	5.0±1	18.5	3.5
TYPE100	TYPE2WS	11.5±1	6±1	4.5±0.5	0.8±0.05	8.0±1	24	5.0±1	20	3.5
TYPE200	TYPE3WS	15.5±1	6±1	5.0±0.5	0.8±0.05	8.0±1	28	5.0±1	25	3.5

Note: TYPE-25/50S is available.

FMP/KNP/NKN/FKN/PNP/PNP V/FAE series: øD is different from above table, please refer to each specification of catalog.

FT Type Forming for Taping

Rated Watts 1/4W, 1/2WS & 0.6W

Body Dimension : L = 6.3±0.5mm

øD = 2.4±0.2mm

Rated Watts : 1/2W & 1WS

Body Dimension : L = 9±0.5mm

øD = 3.3±0.3mm

Rated Watts : 1W & 2WS

Body Dimension : L = 11.5±1.0mm

øD = 4.5±0.5mm

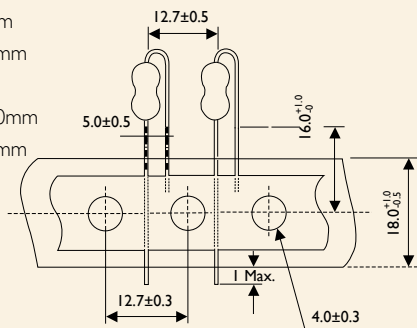

MT Type Forming for Taping

Rated Watts 1/6W, 1/4WS & 0.4W

Body Dimension : L = 3.4±0.3mm

øD = 1.9±0.2mm

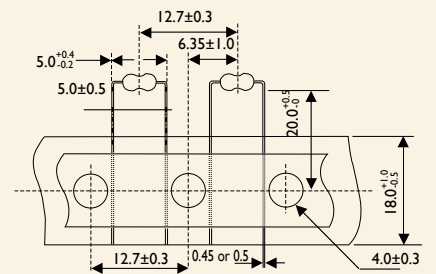

PN Type Forming for Taping

Rated Watts 1/4W, 1/2WS & 0.6W

Body Dimension : L = 6.3±0.5mm

øD = 2.4±0.2mm

Rated Watts : 1/2W & 1WS

Body Dimension : L = 9±0.5mm

øD = 3.3±0.3mm

Rated Watts : 1W & 2WS

Body Dimension : L = 11.5±1.0mm

øD = 4.5±0.5mm

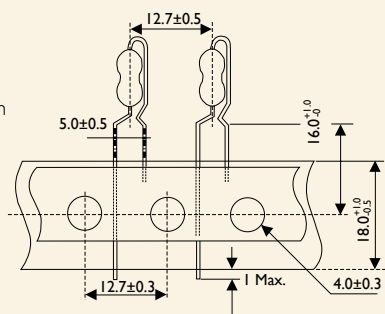

AV Type Forming for Taping

Rated Watts 1/4W, 1/2WS & 0.6W

Body Dimension : L = 6.3±0.5mm

øD = 2.4±0.2mm

Rated Watts : 1/2W & 1WS

Body Dimension : L = 9±0.5mm

øD = 3.3±0.3mm

Rated Watts : 1W & 2WS

Body Dimension : L = 11.5±1.0mm

øD = 4.5±0.5mm

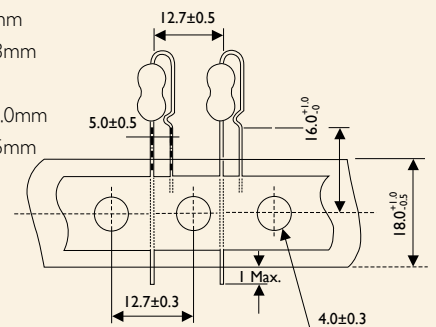



EXPLANATIONS OF ORDERING CODE

MFR	-12	F	T	F	52-	100R
Code 1 - 3 Series Name See Index	Code 4 - 6 Power Rating -05 = \varnothing d0.5mm -06 = \varnothing d0.6mm -07 = \varnothing d0.7mm -08 = \varnothing d0.8mm -10 = \varnothing d1.0mm -14 = \varnothing d1.4mm -12 = 1/6W -25 = 1/4W 25S = 1/4WS -50 = 1/2W 50S = 1/2WS 100 = 1W 1WS = 1WS 200 = 2W 2WS = 2WS 204 = 0.4W 207 = 0.6W 300 = 3W 3WS = 3WS 3WM = 3WM 400 = 4W 500 = 5W 5WS = 5WS 5SS = 5WSS 700 = 7W 7WS = 7WS 10A = 10W 20A = 20W 30A = 30W 40A = 40W 50A = 50W 10S = 10WS 15A = 15W 25A = 25W 10B = 100W 25B = 250W	Code 7 Tolerance P = ± 0.02 % A = ± 0.05 % B = ± 0.1 % C = ± 0.25 % D = ± 0.5 % F = ± 1 % G = ± 2 % J = ± 5 % K = ± 10 % - = Base on Spec.	Code 8 Packing Style T = Tape/Box R = Tape/Reel B = Bulk	Code 9 Temperature Coefficient of Resistance - = Base on Spec. A = ± 5 ppm/ $^{\circ}$ C B = ± 10 ppm/ $^{\circ}$ C C = ± 15 ppm/ $^{\circ}$ C S = ± 20 ppm/ $^{\circ}$ C D = ± 25 ppm/ $^{\circ}$ C E = ± 50 ppm/ $^{\circ}$ C F = ± 100 ppm/ $^{\circ}$ C G = ± 200 ppm/ $^{\circ}$ C H = ± 250 ppm/ $^{\circ}$ C I = ± 300 ppm/ $^{\circ}$ C J = ± 350 ppm/ $^{\circ}$ C	Code 10 - 12 Forming Type 26- = 26mm 52- = 52.4mm 73- = 73mm 81- = 81mm 91- = 91mm F = F Type FK = FK Type FKK = FKK Type FFK = F-form Kink M = M-Type Forming MB = M-form W/flat MT = MT Type Forming MR = MR Type AV = AVIsert PN = PANAsert	Code 13 - 17 Resistance Value 0R1 = 0.1 100R = 100 10K = 10,000 10M = 10,000,000

EXCEPTION:

• Cement series:

<Code 8>: Special packing style code

B: Bulk with wirewound or metal oxide sub-assembly for resistance value

W: Bulk with ceramic based wirewound sub-assembly for resistance value

M: Bulk with metal oxide sub-assembly for resistance value

F: Bulk with Fiberglass based wirewound sub-assembly for resistance value

<Code 10-12>: Without forming code

Example: **SQP500JB-10R**

• JPW series:

<Code 13-17>: without resistance value code

Example: **JPW-06-T-52-**

MARKING AND STANDARD RESISTANCE VALUE FOR THE 10-TO-100 DECADE

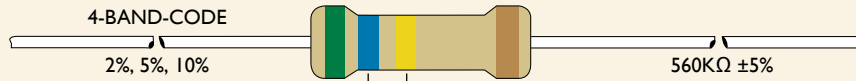

COLOR	1st BAND	2nd BAND	3rd BAND	MULTIPLIER	TOLERANCE
BLACK	0	0	0	1Ω	
BROWN	1	1	1	10Ω	±1% (F)
RED	2	2	2	100Ω	±2% (G)
ORANGE	3	3	3	1KΩ	
YELLOW	4	4	4	10KΩ	
GREEN	5	5	5	100KΩ	±0.5% (D)
BLUE	6	6	6	1MΩ	±0.25% (C)
VIOLET	7	7	7	10MΩ	±0.10% (B)
GREY	8	8	8		±0.05%
WHITE	9	9	9		
GOLD				0.1	±5% (J)
SILVER				0.01	±10% (K)

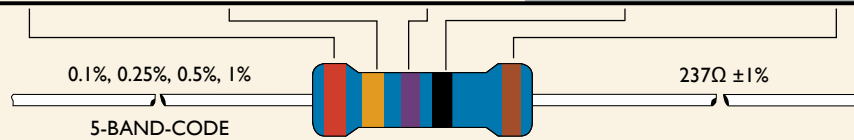

STANDARD RESISTANCE VALUES FOR THE 10-TO-100 DECADE

(Also Usable in Decade Multiples or Sub-Multiples)

RESISTANCE TOLERANCE (±%)																								
0.10%			2%			0.10%			2%			0.10%			2%			0.10%			2%			
0.25%	1%	5%	0.25%	1%	5%	0.25%	1%	5%	0.25%	1%	5%	0.25%	1%	5%	0.25%	1%	5%	0.25%	1%	5%	0.25%	1%	5%	
0.50%	10%	0.50%	10%	0.50%	10%	0.50%	10%	0.50%	10%	0.50%	10%	0.50%	10%	0.50%	10%	0.50%	10%	0.50%	10%	0.50%	10%	0.50%	10%	
10	10	10	14.7	14.7	-	21.5	21.5	-	31.6	31.6	-	46.4	46.4	-	68.1	68.1	68							
10.1	-	-	14.9	-	-	21.8	-	-	32	-	-	47	-	47	69	-	-							
10.2	10.2	-	15	15	15	22.1	22.1	22	32.4	32.4	-	47.5	47.5	-	69.8	69.8	-							
10.4	-	-	15.2	-	-	22.3	-	-	32.8	-	-	48.1	-	-	70.6	-	-							
10.5	10.5	-	15.4	15.4	-	22.6	22.6	-	33.2	33.2	33	48.7	48.7	-	71.5	71.5	-							
10.6	-	-	15.6	-	-	22.9	-	-	33.6	-	-	49.3	-	-	72.3	-	-							
10.7	10.7	-	15.8	15.8	-	23.2	23.2	-	34	34	-	49.9	49.9	-	73.2	73.2	-							
10.9	-	-	16	-	16	23.4	-	-	34.4	-	-	50.5	-	-	74.1	-	-							
11	11	11	16.2	16.2	-	23.7	23.7	-	34.8	34.8	-	51.1	51.1	51	75	75	75							
11.1	-	-	16.4	-	-	24	-	24	35.2	-	-	51.7	-	-	75.9	-	-							
11.3	11.3	-	16.5	16.5	-	24.3	24.3	-	35.7	35.7	-	52.3	52.3	-	76.8	76.8	-							
11.4	-	-	16.7	-	-	24.6	-	-	36.1	-	36	53	-	-	77.7	-	-							
11.5	11.5	-	16.9	16.9	-	24.9	24.9	-	36.5	36.5	-	53.6	53.6	-	78.7	78.7	-							
11.7	-	-	17.2	-	-	25.2	-	-	37	-	-	54.2	-	-	79.6	-	-							
11.8	11.8	-	17.4	17.4	-	25.5	25.5	-	37.4	37.4	-	54.9	54.9	-	80.6	80.6	-							
12	-	12	17.6	-	-	25.8	-	-	37.9	-	-	55.6	-	-	81.6	-	-							
12.1	12.1	-	17.8	17.8	-	26.1	26.1	-	38.3	38.3	-	56.2	56.2	56	82.5	82.5	82							
12.3	-	-	18	-	18	26.4	-	-	38.8	-	-	56.9	-	-	83.5	-	-							
12.4	12.4	-	18.2	18.2	-	26.7	26.7	-	39.2	39.2	39	57.6	57.6	-	84.5	84.5	-							
12.6	-	-	18.4	-	-	27.1	-	27	39.7	-	-	58.3	-	-	85.6	-	-							
12.7	12.7	-	18.7	18.7	-	27.4	27.4	-	40.2	40.2	-	59	59	-	86.6	86.6	-							
12.9	-	-	18.9	-	-	27.7	-	-	40.7	-	-	59.7	-	-	87.6	-	-							
13	13	13	19.1	19.1	-	28	28	-	41.2	41.2	-	60.4	60.4	-	88.7	88.7	-							
13.2	-	-	19.3	-	-	28.4	-	-	41.7	-	-	61.2	-	-	89.8	-	-							
13.3	13.3	-	19.6	19.6	-	28.7	28.7	-	42.2	42.2	-	61.9	61.9	62	90.9	90.9	91							
13.5	-	-	19.8	-	-	29.1	-	-	42.7	-	-	62.6	-	-	92	-	-							
13.7	13.7	-	20	20	20	29.4	29.4	-	43.2	43.2	43	63.4	63.4	-	93.1	93.1	-							
13.8	-	-	20.3	-	-	29.8	-	-	43.7	-	-	64.2	-	-	94.2	-	-							
14	14	-	20.5	20.5	-	30.1	30.1	30	44.2	44.2	-	64.9	64.9	-	95.3	95.3	-							
14.2	-	-	20.8	-	-	30.5	-	-	44.8	-	-	65.7	-	-	96.5	-	-							
14.3	14.3	-	21	21	-	30.9	30.9	-	45.3	45.3	-	66.5	66.5	-	97.6	97.6	-							
14.5	-	-	21.3	-	-	31.2	-	-	45.9	-	-	67.3	-	-	98.8	-	-							
E-192	E-96	E-24	E-192	E-96	E-24	E-192	E-96	E-24	E-192	E-96	E-24	E-192	E-96	E-24	E-192	E-96	E-24	E-192	E-96	E-24	E-192	E-96	E-24	

Note:

A sheet of white paper with rounded corners and horizontal ruling lines, set against a solid orange background. The word "Note:" is printed at the top left. The paper is otherwise blank.

YAGEO - A GLOBAL COMPANY

ASIA

Dongguan, China

Tel. +86 769 8772 0275
Fax. +86 769 8791 0053

Hong Kong, China

Tel. +852 2342 6833
Fax. +852 2342 6588

Mudu, China

Tel. +86 512 6651 8889
Fax. +86 512 6651 9889

Suzhou, China

Tel. +86 512 6825 5568
Fax. +86 512 6825 5386

Qingdao, China

Tel: +86 532 8797 0533
Fax: +86 532 8797 0533

Singapore

Tel. +65 6244 7800
Fax. +65 6244 4943

Tokyo, Japan

Tel. +81 3 6809 3972
Fax. +81 3 6809 3982

Seongnam, Korea

Tel. +82 31 712 4797
Fax. +82 31 712 5866

Kuala Lumpur, Malaysia

Tel. +60 3 8063 8864
Fax. +60 3 8063 7376

Taipei, Taiwan

Tel. +886 2 6629 9999
Fax. +886 2 6628 8886

EUROPE

Roermond, Benelux

Tel. +31 475 385 555
Fax. +31 475 385 589

Hamburg, Germany

Tel. +49 4121 870 189
Fax. +49 4121 870 271

Munich, Germany

Tel. +49 8990 7784 380
Fax. +49 8990 7784 379

Szombathely, Hungary

Tel. +36 94 517 702
Fax. +36 94 517 701

Milan, Italy

Tel. +39 02 6129 1017
Fax. +39 02 6601 7490

Moscow, Russian Federation

Tel. +7 916 625 92 38
Fax. +7 498 610 07 07

NORTH AMERICA

San Jose, U.S.A.

Tel. +1 408 240 6200
Fax. +1 408 240 6201

For a complete listing of all Yageo sales offices, distributors, and representatives, please visit "contact us" at

www.yageo.com

© YAGEO Corporation

All rights are reserved. Reproduction in whole or in part is prohibited without the prior written consent of the copyright owner.

The information presented in this document does not form part of any quotation or contract, is believed to be accurate and reliable and may be changed without notice.

No liability will be accepted by the publisher for any consequence of its use. Publication thereof does not convey nor imply any license under patent or other industrial or intellectual property rights.