

Introducing Grace Inertia Connector 3.3

The Grace Inertia Connector series employs an inertia locking mechanism to simultaneously complete the circuit and then “lock” the connector for ideal mating reliability and prevention of mismatching. These small wire-to-wire connectors can be used in a wide range of large electrical products from home appliances to vending machines, and are a great solution to eliminate human error during assembly. TE also provides the connector in a urethane coating on PCB board for usage in a washing machine or other similar applications.



KEY FEATURES

- The height from PCB to contact is 8mm, preventing urethane coating from flowing into the housing
- Design assurance for preventing header pin deformation when improper insertion happens
- Inertia locking mechanism helps prevent connectors from being disconnected during movement or transportation
- 4 keying methods with different colors avoids blind mating
- Lanceless contacts prevent snagging or entanglement
- Dual beam contact design provides good contact and durability
- Ergonomic design allows easy operation (pulling out manually)
- Designed to be used with an option terminal position assurance device (TPA), which ensures contacts to be fully seated in the housing

APPLICATIONS

- Washing Machine
- Household Appliances
- Urethane Coating on PCB Board

ELECTRICAL

- Voltage Rating: 250V AC/DC
- Current Rating: 4A Max

MECHANICAL

- Position: 4, 6, 8, 10, 12P (Double Row)
- Pitch: 3.3mm
- Wire Gauge: #20 - #24 AWG
- Wire Insulator Range: 1.5 - 2.5mm

MATERIALS

- Housing & TPA: UL94-V0 rated nylon
- Colored Housing & Header: Natural, Blue, Red, Yellow (Black for TPA)
- Contacts: Tin-plated Copper Alloy
- Compliance to Glow wire per IEC 60335-1

SPECIFICATIONS & STANDARDS

- Product Specification: 108-106094
- Application Specification: 114-106094
- Tooling & Applicator: 2088571-2 1552510-2
- cURus: E321453. 

SAMPLES NOW AVAILABLE

te.com/products/GI33



PRODUCT OFFERING

Base Number	Base Number	Positions	KEY A ■ Natural	KEY B ■ Blue	KEY C ■ Red	KEY D ■ Yellow	■ Black
Header Assembly	1971906	4	1-1971906-2	2-1971906-2	3-1971906-2	4-1971906-2	-
		6	1-1971906-3	2-1971906-3	3-1971906-3	4-1971906-3	-
		8	1-1971906-4	2-1971906-4	3-1971906-4	4-1971906-4	-
		10	1-1971906-5	2-1971906-5	3-1971906-5	4-1971906-5	-
		12	1-1971906-6	2-1971906-6	3-1971906-6	4-1971906-6	-
Plug Housing	1971905	4	1-1971905-2	2-1971905-2	3-1971905-2	4-1971905-2	-
		6	1-1971905-3	2-1971905-3	3-1971905-3	4-1971905-3	-
		8	1-1971905-4	2-1971905-4	3-1971905-4	4-1971905-4	-
		10	1-1971905-5	2-1971905-5	3-1971905-5	4-1971905-5	-
		12	1-1971905-6	2-1971905-6	3-1971905-6	4-1971905-6	-
TPA	1971904	4	-	-	-	-	1971904-2
		6	-	-	-	-	1971904-3
		8	-	-	-	-	1971904-4
		10	-	-	-	-	1971904-5
		12	-	-	-	-	1971904-6
Receptacle Contact, Tin plating, Copper Alloy	1983780-1	-	-	-	-	-	-

PCB LAYOUT

12 POSITIONS FOR EXAMPLE

All Dimensions in [mm]

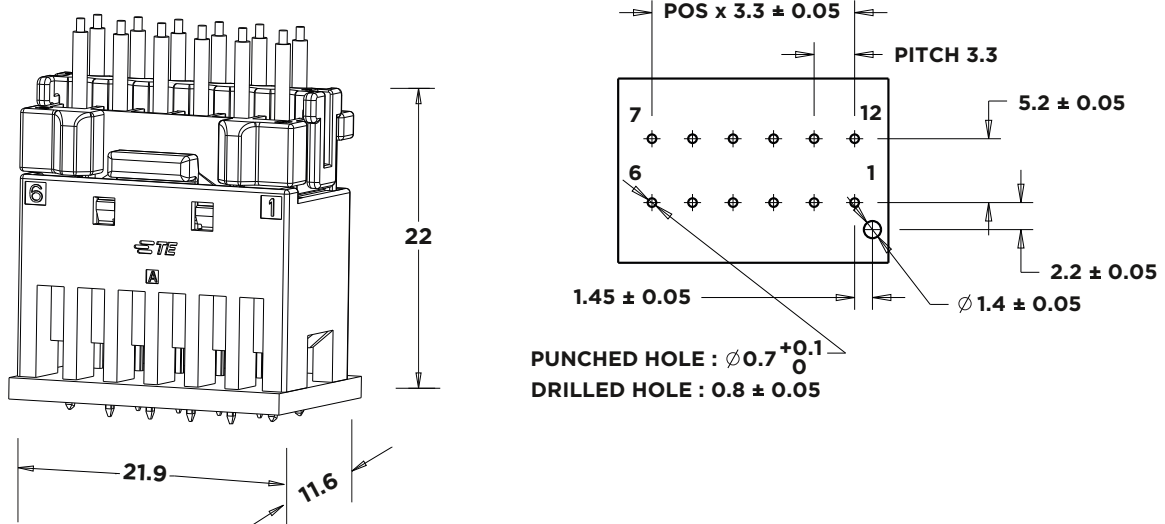

While TE has made every reasonable effort to ensure the accuracy of the information in this flyer, TE does not guarantee that it is error-free, nor does TE make any other representation, warranty or guarantee that the information is accurate, correct, reliable or current. TE reserves the right to make any adjustments to the information contained herein at any time without notice. TE expressly disclaims all implied warranties regarding the information contained herein, including, but not limited to, any implied warranties of merchantability or fitness for a particular purpose. The dimensions in this flyer are for reference purposes only and are subject to change without notice. Specifications are subject to change without notice. Consult TE for the latest dimensions and design specifications.

te.com/products/GI33

