

Standard Heat Sinks

Suggested hole patterns:

DEVICE	HOLE PATTERN
TO-3	01E
TO-220	14X
TO-220-2	14A
TO-66	03B

Other hole patterns available.
See pages 27-32.

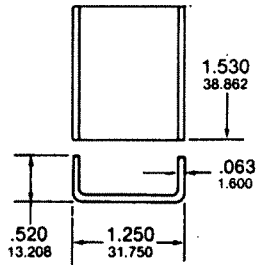

Material... 1100-H14 Aluminum
Finish..... Black Anodize

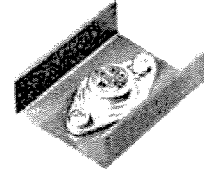
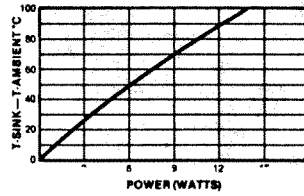

7-335

C

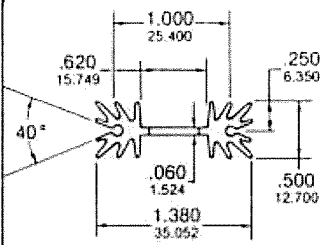

7-338

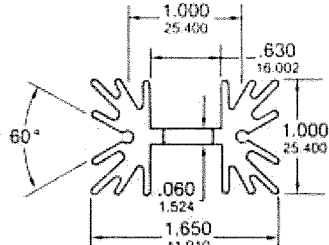

7-339

Tin-plated steel roll pins for solder mount

Material... 6063-T5 aluminum
Finish..... Black Anodize

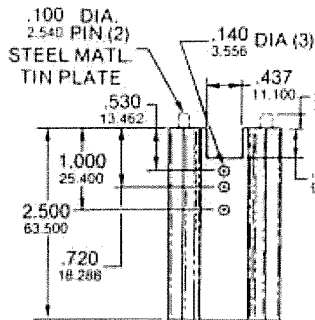
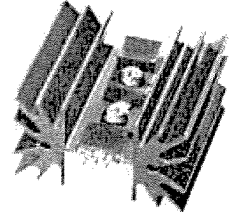
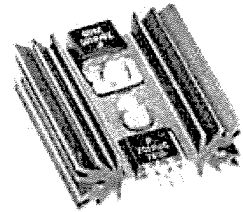
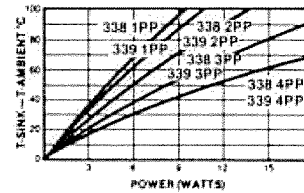

4PP

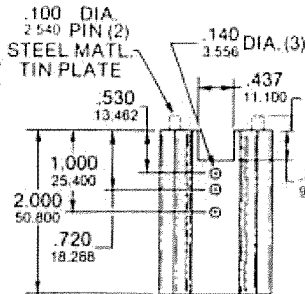

3PP

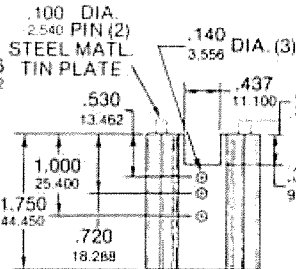

2PP



1PP

7-338 & 7-339
-1,-2,-3,-4

Low Power

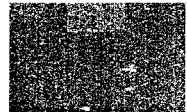

Mouser Electronics

Authorized Distributor

Click to View Pricing, Inventory, Delivery & Lifecycle Information:

[CTS:](#)

[73394PPBA](#) [73384PPBA](#) [73391PPBA](#) [73393PPBA](#) [73381PPBA](#)