

DUAL ULTRA MICROPOWER RAIL-TO-RAIL CMOS OPERATIONAL AMPLIFIER

GENERAL DESCRIPTION

The ALD4706A/ALD4706B/ALD4706 is a quad monolithic CMOS ultra micropower high slew-rate operational amplifier intended for a broad range of analog applications using $\pm 1V$ to $\pm 5V$ dual power supply systems, as well as +2V to +10V battery operated systems. All device characteristics are specified for +5V single supply or $\pm 2.5V$ dual supply systems. Total supply current for four operational amplifiers is 200 μA maximum at 5V supply voltage. It is manufactured with Advanced Linear Devices' enhanced ACMOS silicon gate CMOS process.

The ALD4706A/ALD4706B/ALD4706 is designed to offer a trade-off of performance parameters providing a wide range of desired specifications. It has been developed specifically for the +5V single supply or $\pm 1V$ to $\pm 5V$ dual supply user and offers the popular industry standard pin configuration of LM324 types and ICL7641 types.

Several important characteristics of the device make application easier to implement at these voltages. First, each operational amplifier can operate with rail-to-rail input and output voltages. This means the signal input voltage and output voltage can be equal to or near to the positive and negative supply voltages. This feature allows numerous analog serial stages and flexibility in input signal bias levels. Second, each device was designed to accommodate mixed applications where digital and analog circuits may operate off the same power supply or battery. Third, the output stage can typically drive up to 25pF capacitive and 20K Ω resistive loads. These features, combined with extremely low input currents, high open loop voltage gain of 100V/mV, useful bandwidth of 200KHz, a slew rate of 0.17V/ μs , low power dissipation of 0.5mW, low offset voltage and temperature drift, make the ALD4706A/ALD4706B/ALD4706 a versatile, ultra micropower quad operational amplifier.

The ALD4706A/ALD4706B/ALD4706, designed and fabricated with silicon gate CMOS technology, offers 0.1pA typical input bias current. Due to low voltage and low power operation, reliability and operating characteristics, such as input bias currents and warm up time, are greatly improved. Additionally, robust design and rigorous screening make this device especially suitable for operation in temperature-extreme environments and rugged conditions.

ORDERING INFORMATION ("L" suffix denotes lead-free (RoHS))

| Operating Temperature Range | | |
|-------------------------------------|----------------------------|-----------------------|
| 0°C to +70°C | 0°C to +70°C | -55°C to 125°C |
| 14-Pin Small Outline Package (SOIC) | 14-Pin Plastic Dip Package | 14-Pin CERDIP Package |
| ALD4706ASBL | ALD4706APBL | ALD4706ADB |
| ALD4706BSBL | ALD4706BPBL | ALD4706BDB |
| ALD4706SBL | ALD4706PBL | ALD4706DB |

* Contact factory for leaded (non-RoHS) or high temperature versions.

FEATURES

- All parameters specified for + 5V single supply or $\pm 2.5V$ dual supply systems
- Rail- to- rail input and output voltage ranges
- Unity gain stable
- Extremely low input bias currents -- 0.1pA
- High source impedance applications
- Dual power supply $\pm 1.0V$ to $\pm 5.0V$
- Single power supply +2V to +10V
- High voltage gain
- Output short circuit protected
- Unity gain bandwidth of 0.2MHz
- Slew rate of 0.17V/ μs
- Power dissipation of 20 μA per op amp
- Symmetrical output drive
- Suitable for rugged, temperature-extreme environments

APPLICATIONS

- Voltage follower/buffer/amplifier
- Charge integrator
- Photodiode amplifier
- Data acquisition systems
- High performance portable instruments
- Signal conditioning circuits
- Sensor and transducer amplifiers
- Low leakage amplifiers
- Active filters
- Sample/Hold amplifier
- Picoammeter
- Current to voltage converter

PIN CONFIGURATION

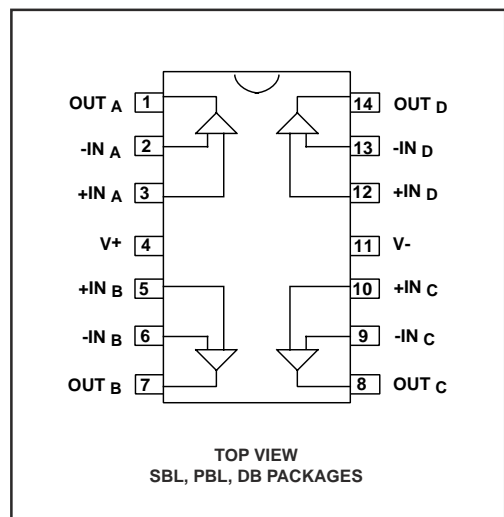

ABSOLUTE MAXIMUM RATINGS

Supply voltage, V_+ _____ 10.6V
 Differential input voltage range _____ -0.3V to V_+ +0.3V
 Power dissipation _____ 600 mW
 Operating temperature range SBL, PBL packages _____ 0°C to +70°C
 DB package _____ -55°C to +125°C
 Storage temperature range _____ -65°C to +150°C
 Lead temperature, 10 seconds _____ +260°C

CAUTION: ESD Sensitive Device. Use static control procedures in ESD controlled environment.

OPERATING ELECTRICAL CHARACTERISTICS

$T_A = 25^\circ\text{C}$ $V_S = \pm 2.5\text{V}$ unless otherwise specified

| Parameter | Symbol | 4706A | | | 4706B | | | 4706 | | | Unit | Test Conditions |
|------------------------------|---------------------|--------------|-----------|------------|--------------|-----------|------------|--------------|-----------|--------------|------------------------------|--|
| | | Min | Typ | Max | Min | Typ | Max | Min | Typ | Max | | |
| Supply Voltage | V_S | ±1.0 | | ±5.0 | ±1.0 | | ±5.0 | ±1.0 | | ±5.0 | V | Dual Supply Single Supply |
| | V_+ | 2.0 | | 10.0 | 2.0 | | 10.0 | 2.0 | | 10.0 | V | |
| Input Offset Voltage | V_{OS} | | | 2.0 2.8 | | | 5.0 5.8 | | | 10.0 11.0 | mV mV | $R_S \leq 100\text{K}\Omega$ $0^\circ\text{C} \leq T_A \leq +70^\circ\text{C}$ |
| Input Offset Current | I_{OS} | | 0.1 | 20 200 | | 0.1 | 20 200 | | 0.1 | 20 200 | pA pA | $T_A = 25^\circ\text{C}$ $0^\circ\text{C} \leq T_A \leq +70^\circ\text{C}$ |
| Input Bias Current | I_B | | 0.1 | 20 200 | | 0.1 | 20 200 | | 0.1 | 20 200 | pA pA | $T_A = 25^\circ\text{C}$ $0^\circ\text{C} \leq T_A \leq +70^\circ\text{C}$ |
| Input Voltage Range | V_{IR} | -0.3 -2.8 | | 5.3 2.8 | -0.3 -2.8 | | 5.3 2.8 | -0.3 -2.8 | | 5.3 2.8 | V V | $V_+ = +5$ $V_S = \pm 2.5\text{V}$ |
| Input Resistance | R_{IN} | | 10^{13} | | | 10^{13} | | | 10^{13} | | Ω | |
| Input Offset Voltage Drift | TCV_{OS} | | 7 | | | 7 | | | 10 | | $\mu\text{V}/^\circ\text{C}$ | $R_S \leq 100\text{K}\Omega$ |
| Power Supply Rejection Ratio | PSRR | 65 65 | 83 83 | | 65 65 | 83 83 | | 60 60 | 83 83 | | dB dB | $R_S \leq 100\text{K}\Omega$ $0^\circ\text{C} \leq T_A \leq +70^\circ\text{C}$ |
| Common Mode Rejection Ratio | CMRR | 65 65 | 83 83 | | 65 65 | 83 83 | | 60 60 | 83 83 | | dB dB | $R_S \leq 100\text{K}\Omega$ $0^\circ\text{C} \leq T_A \leq +70^\circ\text{C}$ |
| Large Signal Voltage Gain | A_v | 10 10 | 60 300 | | 10 10 | 60 300 | | 7 7 | 50 300 | | V/mV V/mV V/mV | $R_L = 100\text{K}\Omega$ $R_L \geq 1\text{M}\Omega$ $R_L = 100\text{K}\Omega$ |
| Output Voltage Range | $V_{O\text{ low}}$ | | 0.001 | 0.01 | | 0.001 | 0.01 | | 0.001 | 0.01 | V | $R_L = 1\text{M}\Omega$ $V_+ = +5\text{V}$ $0^\circ\text{C} \leq T_A \leq +70^\circ\text{C}$ |
| | $V_{O\text{ high}}$ | 4.99 | 4.999 | | 4.99 | 4.999 | | 4.99 | 4.999 | | V | |
| | $V_{O\text{ low}}$ | | -2.40 | -2.25 | | -2.40 | -2.25 | | -2.40 | -2.25 | V | $R_L = 100\text{K}\Omega$ $V_S = \pm 2.5\text{V}$ $0^\circ\text{C} \leq T_A \leq +70^\circ\text{C}$ |
| | $V_{O\text{ high}}$ | 2.25 | 2.40 | | 2.25 | 2.40 | | 2.25 | 2.40 | | V | |
| Output Short Circuit Current | I_{SC} | | 200 | | | 200 | | | 200 | | μA | |
| Supply Current | I_S | | 120 | 200 | | 120 | 200 | | 120 | 200 | μA | $V_{IN} = 0\text{V}$ No Load |
| Power Dissipation | P_D | | | 1.0 | | | 1.0 | | | 1.0 | μW | All amplifiers $V_S = \pm 2.5\text{V}$ |

OPERATING ELECTRICAL CHARACTERISTICS (cont'd)

$T_A = 25^\circ\text{C}$ $V_S = \pm 2.5\text{V}$ unless otherwise specified

| Parameter | Symbol | 4706A | | | 4706B | | | 4706 | | | Unit | Test Conditions |
|--------------------|----------|-------|------|-----|-------|------|-----|------|------|-----|------------------|---|
| | | Min | Typ | Max | Min | Typ | Max | Min | Typ | Max | | |
| Input Capacitance | C_{IN} | | 1 | | | 1 | | | 1 | | pF | |
| Bandwidth | B_W | | 200 | | | 200 | | | 200 | | KHz | |
| Slew Rate | S_R | | 0.17 | | | 0.17 | | | 0.17 | | V/ μs | $R_L = 100\text{K}\Omega$ $A_V = +1$ |
| Rise time | t_r | | 1.0 | | | 1.0 | | | 1.0 | | μs | $R_L = 100\text{K}\Omega$ |
| Overshoot Factor | | | 20 | | | 20 | | | 20 | | % | $R_L = 100\text{K}\Omega$ $C_L = 25\text{pF}$ |
| Settling Time | t_s | | 10.0 | | | 10.0 | | | 10.0 | | μs | 0.1% $A_V = 1$ $C_L = 25\text{pF}$ $R_L = 100\text{K}\Omega$ |
| Channel Separation | C_S | | 140 | | | 140 | | | 140 | | dB | $A_V = 100$ |

$T_A = 25^\circ\text{C}$ $V_S = \pm 1.0\text{V}$ unless otherwise specified

| Parameter | Symbol | 4706A | | | 4706B | | | 4706 | | | Unit | Test Conditions |
|------------------------------|---|-------|---------------|-------|-------|---------------|-------|------|---------------|-------|------------------|-----------------------------------|
| | | Min | Typ | Max | Min | Typ | Max | Min | Typ | Max | | |
| Power Supply Rejection Ratio | PSRR | | 80 | | | 80 | | | 80 | | dB | $R_S \leq 1\text{M}\Omega$ |
| Common Mode Rejection Ratio | CMRR | | 80 | | | 80 | | | 80 | | dB | $R_S \leq 1\text{M}\Omega$ |
| Large Signal Voltage Gain | A_V | | 50 | | | 50 | | | 50 | | V/mV | $R_L = 1\text{M}\Omega$ |
| Output Voltage Range | $V_{O\text{ low}}$ $V_{O\text{ high}}$ | .90 | -0.95 0.95 | -0.90 | .90 | -0.95 0.95 | -0.90 | .90 | -0.95 0.95 | -0.90 | V V | $R_L = 1\text{M}\Omega$ |
| Bandwidth | B_W | | 200 | | | 200 | | | 200 | | KHz | |
| Slew Rate | S_R | | 0.1 | | | 0.1 | | | 0.1 | | V/ μs | $A_V = +1$ $C_L = 25\text{pF}$ |

$V_S = \pm 2.5\text{V}$ $-55^\circ\text{C} \leq T_A \leq +125^\circ\text{C}$ unless otherwise specified

| Parameter | Symbol | 4706ADB | | | 4706BDB | | | 4706DB | | | Unit | Test Conditions |
|------------------------------|---|---------|---------------|-------|---------|---------------|-------|--------|---------------|-------|--------|----------------------------|
| | | Min | Typ | Max | Min | Typ | Max | Min | Typ | Max | | |
| Input Offset Voltage | V_{OS} | | | 3.0 | | | 6.0 | | | 15.0 | mV | $R_S \leq 1\text{M}\Omega$ |
| Input Offset Current | I_{OS} | | 1 | 4 | | 1 | 4 | | 1 | 4 | nA | |
| Input Bias Current | I_B | | 1 | 4 | | 1 | 4 | | 1 | 4 | nA | |
| Power Supply Rejection Ratio | PSRR | 60 | 75 | | 60 | 75 | | 60 | 75 | | dB | $R_S \leq 1\text{M}\Omega$ |
| Common Mode Rejection Ratio | CMRR | 60 | 83 | | 60 | 83 | | 60 | 83 | | dB | $R_S \leq 1\text{M}\Omega$ |
| Large Signal Voltage Gain | A_V | 10 | 50 | | 10 | 50 | | 7 | 50 | | V/mV | $R_L = 1\text{M}\Omega$ |
| Output Voltage Range | $V_{O\text{ low}}$ $V_{O\text{ high}}$ | 2.25 | -2.40 2.40 | -2.25 | 2.25 | -2.40 2.40 | -2.25 | 2.25 | -2.40 2.40 | -2.25 | V V | $R_L = 1\text{M}\Omega$ |

Design & Operating Notes:

1. The ALD4706A/ALD4706B/ALD4706 CMOS operational amplifier uses a 3 gain stage architecture and an improved frequency compensation scheme to achieve large voltage gain, high output driving capability, and better frequency stability. In a conventional CMOS operational amplifier design, compensation is achieved with a pole splitting capacitor together with a nulling resistor. This method is, however, very bias dependent and thus cannot accommodate the large range of supply voltage operation as is required from a stand alone CMOS operational amplifier. The ALD4706A/ALD4706B/ALD4706 is internally compensated for unity gain stability using a novel scheme that does not use a nulling resistor. This scheme produces a clean single pole roll off in the gain characteristics while providing for more than 70 degrees of phase margin at the unity gain frequency.
2. The ALD4706A/ALD4706B/ALD4706 has complementary p-channel and n-channel input differential stages connected in parallel to accomplish rail to rail input common mode voltage range. This means that with the ranges of common mode input voltage close to the power supplies, one of the two differential stages is switched off internally. To maintain compatibility with other operational amplifiers, this switching point has been selected to be about 1.5V below the positive supply voltage. Since offset voltage trimming on the ALD4706A/ALD4706B/ALD4706 is made when the input voltage is symmetrical to the supply voltages, this internal switching does not affect a large variety of applications such as an inverting amplifier or non-inverting amplifier with a gain larger than 2.5 (5V operation), where the common mode voltage does not make excursions above this switching point. The user should however, be aware that this switching does take place if the operational amplifier is connected as a unity gain buffer and should make provision in his design to allow for input offset voltage variations.
3. The input bias and offset currents are essentially input protection diode reverse bias leakage currents, and are typically less than 0.1pA

at room temperature. This low input bias current assures that the analog signal from the source will not be distorted by input bias currents. Normally, this extremely high input impedance of greater than $10^{13}\Omega$ would not be a problem as the source impedance would limit the node impedance. However, for applications where source impedance is very high, it may be necessary to limit noise and hum pickup through proper shielding.

4. The output stage consists of class AB complementary output drivers, capable of driving a low resistance load. The output voltage swing is limited by the drain to source on-resistance of the output transistors as determined by the bias circuitry, and the value of the load resistor. When connected in the voltage follower configuration, the oscillation resistant feature, combined with the rail to rail input and output feature, makes an effective analog signal buffer for medium to high source impedance sensors, transducers, and other circuit networks.
5. The ALD4706A/ALD4706B/ALD4706 operational amplifier has been designed to provide full static discharge protection. Internally, the design has been carefully implemented to minimize latch up. However, care must be exercised when handling the device to avoid strong static fields that may degrade a diode junction, causing increased input leakage currents. In using the operational amplifier, the user is advised to power up the circuit before, or simultaneously with, any input voltages applied and to limit input voltages to not exceed 0.3V of the power supply voltage levels.
6. The ALD4706A/ALD4706B/ALD4706, with its ultra micropower operation, offers numerous benefits in reduced power supply requirements, less noise coupling and current spikes, less thermally induced drift, better overall reliability due to lower self heating, and lower input bias current. It requires practically no warm up time as the chip junction heats up to only 0.1°C above ambient temperature under most operating conditions.

TYPICAL PERFORMANCE CHARACTERISTICS

SUPPLY CURRENT AS A FUNCTION OF SUPPLY VOLTAGE

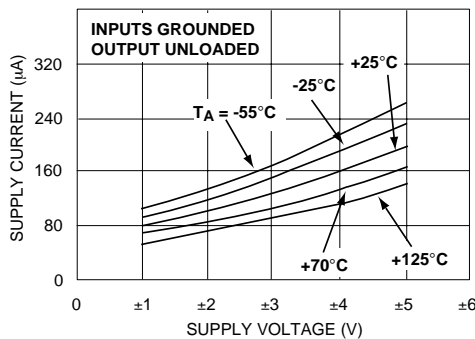

COMMON MODE INPUT VOLTAGE RANGE AS A FUNCTION OF SUPPLY VOLTAGE

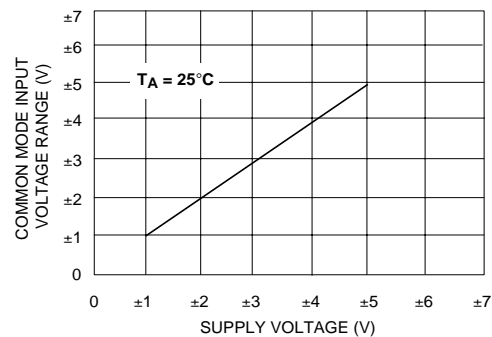

OPEN LOOP VOLTAGE GAIN AS A FUNCTION OF LOAD RESISTANCE

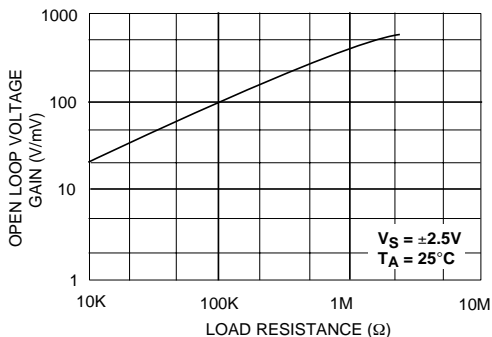

INPUT BIAS CURRENT AS A FUNCTION OF AMBIENT TEMPERATURE

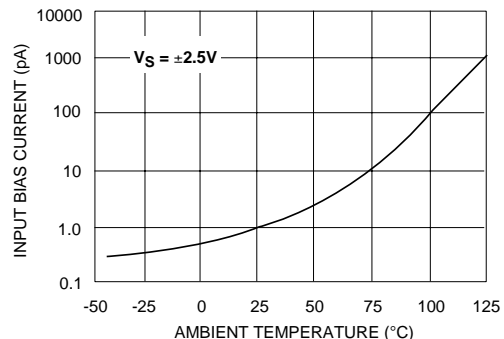

TYPICAL PERFORMANCE CHARACTERISTICS (cont'd)

OPEN LOOP VOLTAGE GAIN AS A FUNCTION OF SUPPLY VOLTAGE AND TEMPERATURE

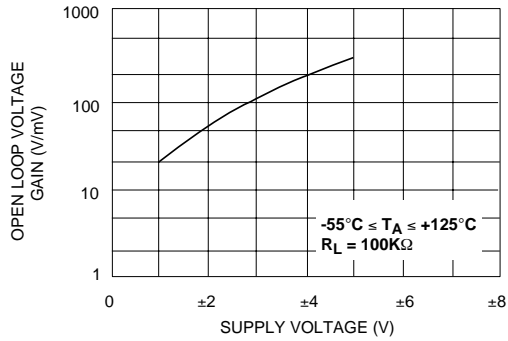

OUTPUT VOLTAGE SWING AS A FUNCTION OF SUPPLY VOLTAGE

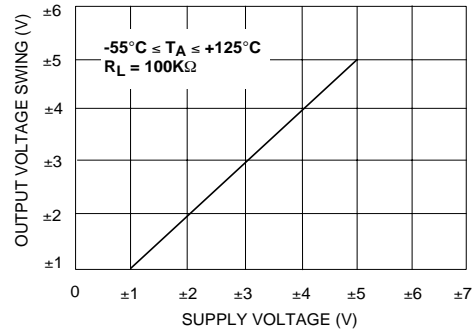

INPUT OFFSET VOLTAGE AS A FUNCTION OF AMBIENT TEMPERATURE REPRESENTATIVE UNITS

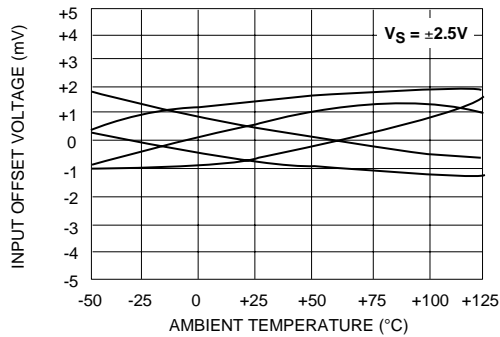

OPEN LOOP VOLTAGE GAIN AS A FUNCTION OF FREQUENCY

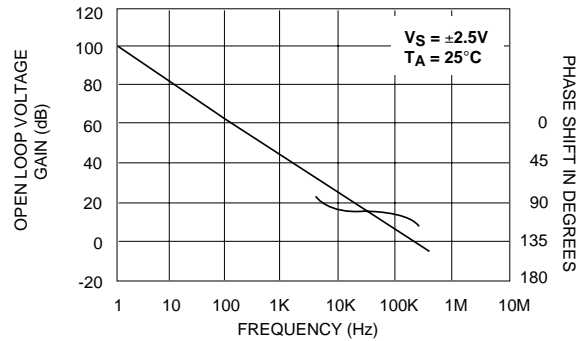

INPUT OFFSET VOLTAGE AS A FUNCTION OF COMMON MODE INPUT VOLTAGE

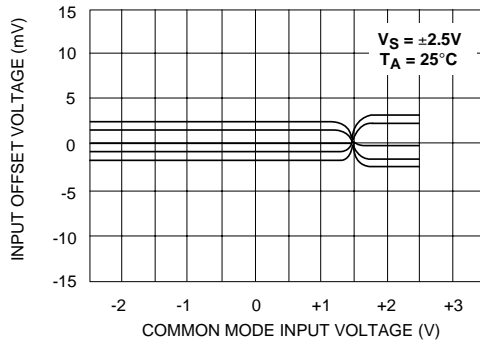

LARGE - SIGNAL TRANSIENT RESPONSE

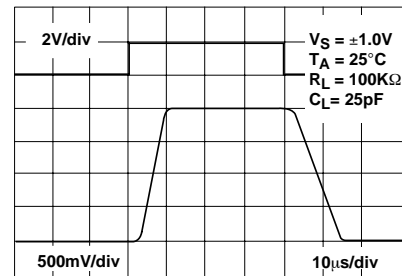

LARGE - SIGNAL TRANSIENT RESPONSE

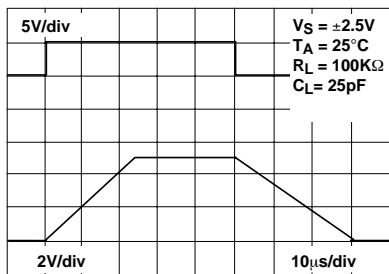

SMALL - SIGNAL TRANSIENT RESPONSE

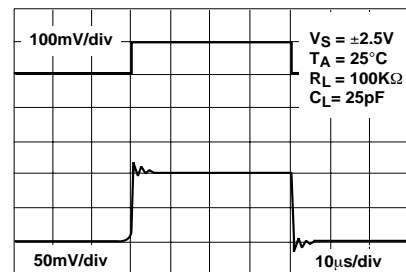

TYPICAL APPLICATIONS

V TO I AMPLIFIER

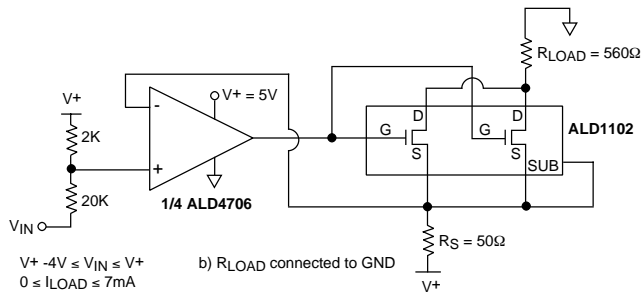
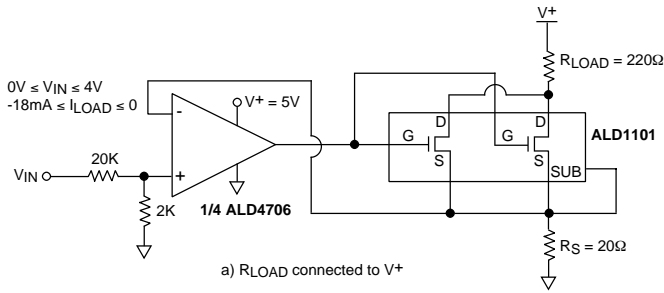

RAIL-TO-RAIL VOLTAGE FOLLOWER/BUFFER

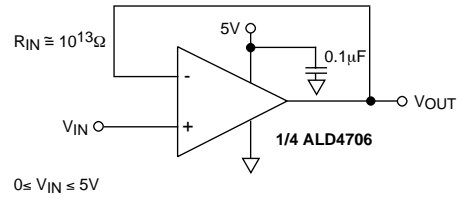
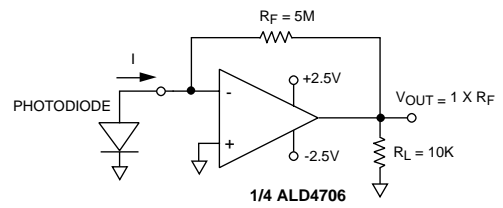
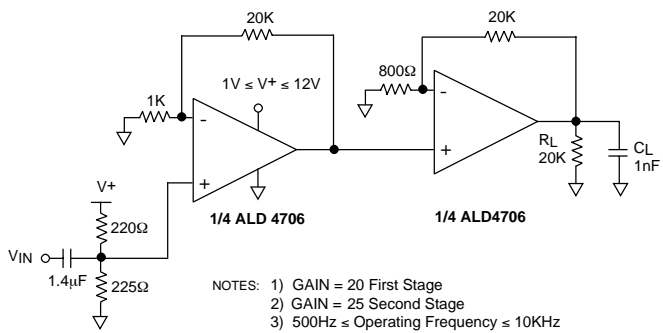

PHOTO DETECTOR CURRENT TO VOLTAGE CONVERTER



TWO STAGE HIGH GAIN AMPLIFIER



RAIL-TO-RAIL WINDOW COMPARATOR

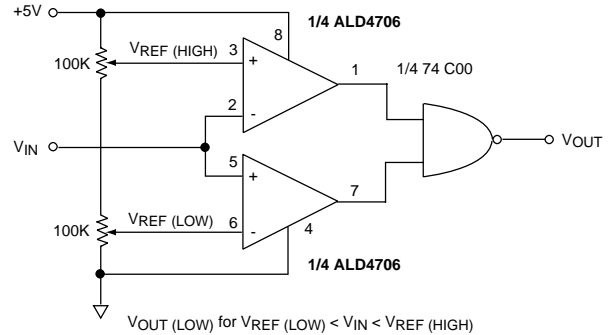

HIGH INPUT IMPEDANCE RAIL-TO-RAIL PRECISION DC SUMMING AMPLIFIER

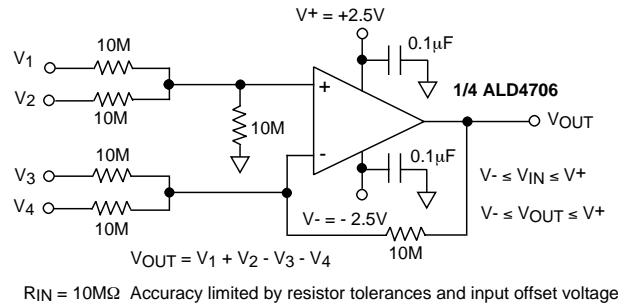

SOIC-14 PACKAGE DRAWING

14 Pin Plastic SOIC Package

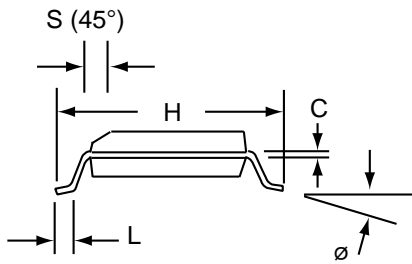
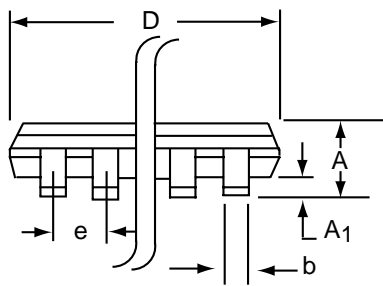
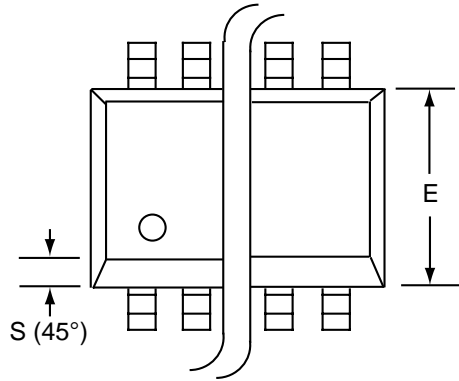

| Dim | Millimeters | | Inches | |
|----------------|-------------|-------|-----------|-------|
| | Min | Max | Min | Max |
| A | 1.35 | 1.75 | 0.053 | 0.069 |
| A ₁ | 0.10 | 0.25 | 0.004 | 0.010 |
| b | 0.35 | 0.45 | 0.014 | 0.018 |
| C | 0.18 | 0.25 | 0.007 | 0.010 |
| D-14 | 8.55 | 8.75 | 0.336 | 0.345 |
| E | 3.50 | 4.05 | 0.140 | 0.160 |
| e | 1.27 BSC | | 0.050 BSC | |
| H | 5.70 | 6.30 | 0.224 | 0.248 |
| L | 0.60 | 0.937 | 0.024 | 0.037 |
| ø | 0° | 8° | 0° | 8° |
| S | 0.25 | 0.50 | 0.010 | 0.020 |

PDIP-14 PACKAGE DRAWING

14 Pin Plastic DIP Package

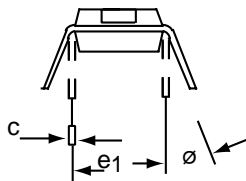
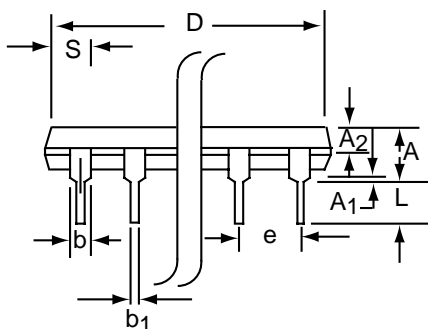
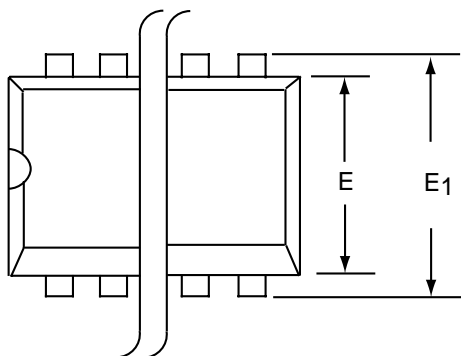

| Dim | Millimeters | | Inches | |
|----------------|-------------|-------|--------|-------|
| | Min | Max | Min | Max |
| A | 3.81 | 5.08 | 0.105 | 0.200 |
| A ₁ | 0.38 | 1.27 | 0.015 | 0.050 |
| A ₂ | 1.27 | 2.03 | 0.050 | 0.080 |
| b | 0.89 | 1.65 | 0.035 | 0.065 |
| b ₁ | 0.38 | 0.51 | 0.015 | 0.020 |
| c | 0.20 | 0.30 | 0.008 | 0.012 |
| D-14 | 17.27 | 19.30 | 0.680 | 0.760 |
| E | 5.59 | 7.11 | 0.220 | 0.280 |
| E ₁ | 7.62 | 8.26 | 0.300 | 0.325 |
| e | 2.29 | 2.79 | 0.090 | 0.110 |
| e ₁ | 7.37 | 7.87 | 0.290 | 0.310 |
| L | 2.79 | 3.81 | 0.110 | 0.150 |
| S-14 | 1.02 | 2.03 | 0.040 | 0.080 |
| θ | 0° | 15° | 0° | 15° |

CERDIP-14 PACKAGE DRAWING

14 Pin CERDIP Package

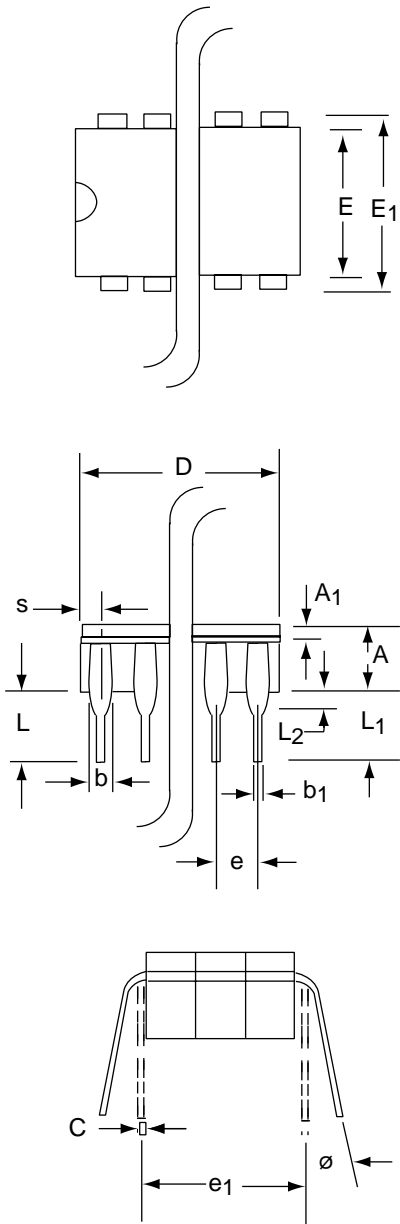

| Dim | Millimeters | | Inches | |
|----------------------|-------------|-------|-----------|-------|
| | Min | Max | Min | Max |
| A | 3.55 | 5.08 | 0.140 | 0.200 |
| A₁ | 1.27 | 2.16 | 0.050 | 0.085 |
| b | 0.97 | 1.65 | 0.038 | 0.065 |
| b₁ | 0.36 | 0.58 | 0.014 | 0.023 |
| C | 0.20 | 0.38 | 0.008 | 0.015 |
| D-14 | -- | 19.94 | -- | 0.785 |
| E | 5.59 | 7.87 | 0.220 | 0.310 |
| E₁ | 7.73 | 8.26 | 0.290 | 0.325 |
| e | 2.54 BSC | | 0.100 BSC | |
| e₁ | 7.62 BSC | | 0.300 BSC | |
| L | 3.81 | 5.08 | 0.150 | 0.200 |
| L₁ | 3.18 | -- | 0.125 | -- |
| L₂ | 0.38 | 1.78 | 0.015 | 0.070 |
| S | -- | 2.49 | -- | 0.098 |
| ∅ | 0° | 15° | 0° | 15° |

Mouser Electronics

Authorized Distributor

Click to View Pricing, Inventory, Delivery & Lifecycle Information:

[Advanced Linear Devices:](#)

[ALD4706BPBL](#) [ALD4706PBL](#) [ALD4706APBL](#) [ALD4706BSBL](#) [ALD4706ASBL](#) [ALD4706SBL](#)