

ASMT-Jx3x

3 W Mini Power LED Light Source



Data Sheet



Description

The 3 W Mini Power LED Light Source is a high performance energy efficient device that can handle high thermal and high driving current. Option with electrically isolated metal slug is also available.

The low profile package design and ultra small footprint is suitable for a wide variety of applications especially where space and height is a constraint.

The package is compatible with reflow soldering process. To facilitate easy pick and place assembly, the LEDs are packed in EIA-compliant tape and reel.

Features

- Available in Deep Red, Red, Red Orange, Amber, Green, Blue, and Royal Blue
- Small footprint and low profile
- Symmetrical outline
- Energy efficient
- Direct heat transfer from metal slug to motherboard
- Compatible with reflow soldering process
- High current operation
- Long operation life
- Wide viewing angle
- Silicone encapsulation
- Non-ESD sensitive (threshold > 16 kV)
- MSL 1 products

Applications

- Sign backlight
- Safety, exit and emergency sign lightings
- Specialty lighting such as task lighting and reading lights
- Retail display
- Commercial lighting
- Accent or marker lightings, strip or step lightings
- Portable lightings, bicycle head lamp, torch lights.
- Decorative lighting
- Architectural lighting
- Pathway lighting
- Street lighting
- Pedestrian street lighting
- Tunnel lighting
- Horticulture

CAUTION: Customer is advised to keep the LEDs in the MBB when not in use as prolonged exposure to environment might cause the silver plated leads to tarnish, which might cause difficulties in soldering.

Package Dimensions

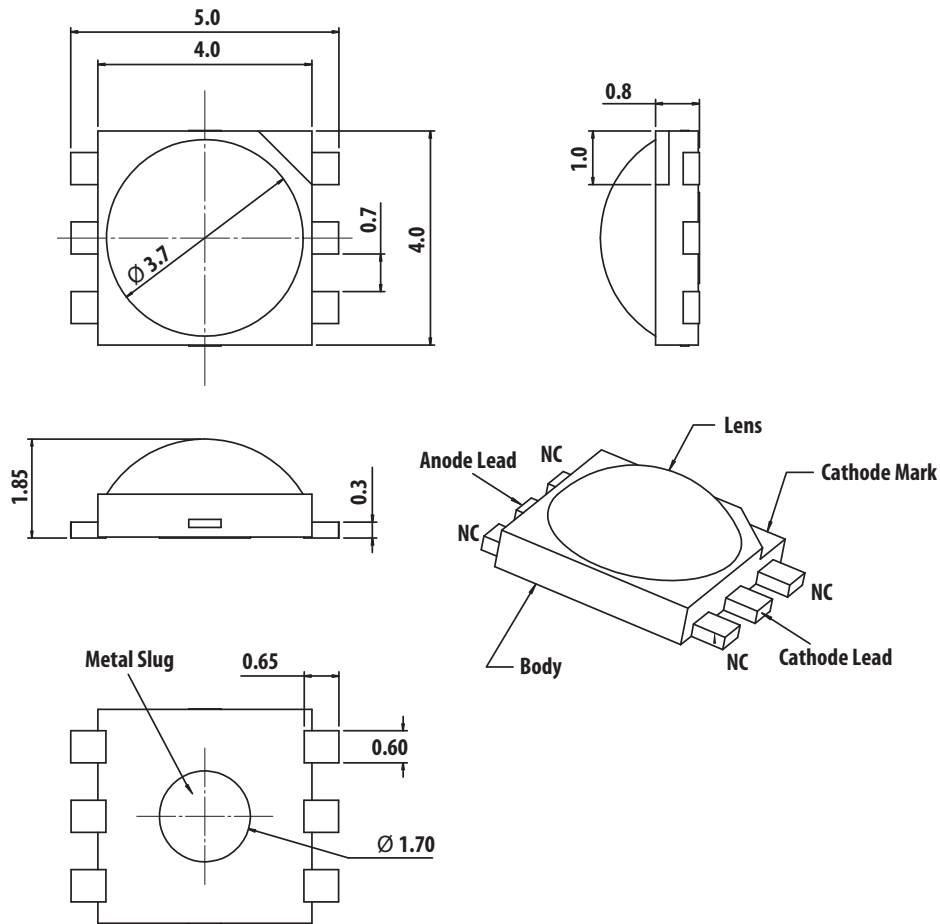
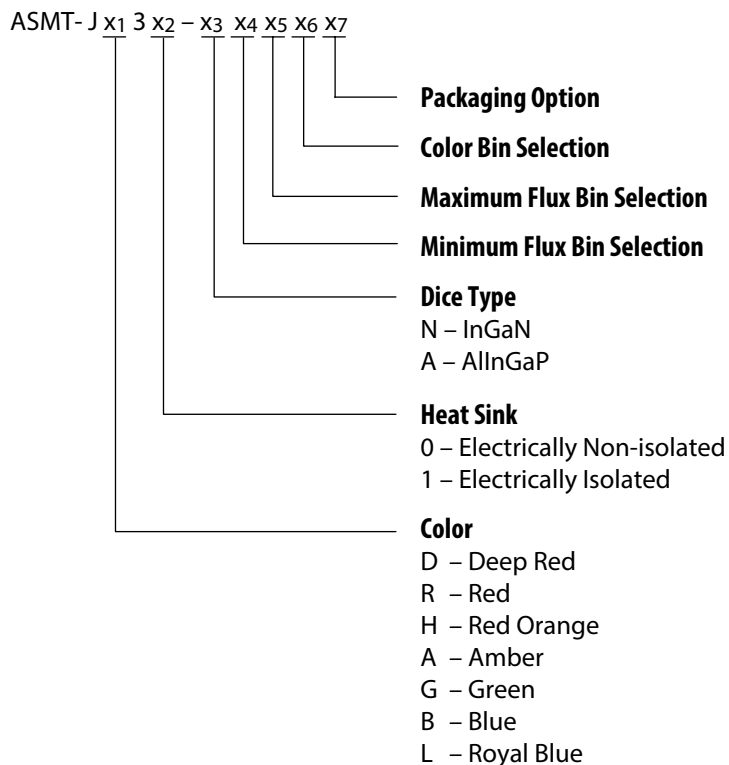

Figure 1. ASMT-Jx3x package outline drawing

Notes:

1. All dimensions in millimeters.
2. Metal slug is connected to anode for electrically non-isolated option.
3. Tolerance is ± 0.1 mm, unless otherwise specified.
4. Terminal finish: Ag plating.
5. Corresponding NC (No Connection) leads adjacent to anode and cathode leads can be electrically short.

Part Numbering System



Note:

1. For selection details, see page 10.

Device Selection Guide ($T_j = 25\text{ }^\circ\text{C}$)

Part Number	Color	Luminous Flux (lm) / Radiometric Power (mW), Φ_V ^[1,2]			Test Current (mA)	Dice Technology	Electrically Isolated Metal Slug
		Min.	Typ.	Max.			
ASMT-JD30-ALN01	Deep Red	175 mW	240 mW	355 mW	350	AllnGaP	No
ASMT-JR30-AST01	Red	51.7	58.0	87.4	350	AllnGaP	No
ASMT-JH30-ARS01	Red Orange	39.8	48.0	67.2	350	AllnGaP	No
ASMT-JA30-ARS01	Amber	39.8	48.0	67.2	350	AllnGaP	No
ASMT-JG31-NUW01	Green	87.4	110.0	129.5	350	InGaN	Yes
ASMT-JB31-NNP01	Blue	18.1	25.0	30.6	350	InGaN	Yes
ASMT-JL31-NRS01	Royal Blue	515 mW	600 mW	685.0 mW	350	InGaN	Yes

Notes:

1. Φ_V is the total luminous flux / radiometric power output as measured with an integrating sphere at 25 ms mono pulse condition.
2. Flux tolerance is $\pm 10\%$.

Absolute Maximum Ratings

Parameter	AllnGaP	InGaN	Units
DC Forward Current ^[1]	700	700	mA
Peak Pulsing Current	1500	2400	mA
Power Dissipation	1820	2730	mW
LED Junction Temperature	125	135	°C
Operating Metal Slug Temperature Range at 350 mA	-40 to +115	-40 to +120	°C
Operating Metal Slug Temperature Range at 700 mA	-40 to +100	-40 to +105	°C
Storage Temperature Range	-40 to +120	-40 to + 120	°C
Soldering Temperature	See Figure 24		
Reverse Voltage ^[2]	Not recommended		

Notes:

1. Derate linearly based on Figure 10 for AllnGaP and Figure 20 for InGaN.
2. Not designed for reverse-bias operation.

Optical Characteristics at 350 mA (T_J = 25 °C)

Part Number	Color	Peak Wavelength, λ_{PEAK} (nm)	Dominant Wavelength, λ_D ^[1] (nm)	Viewing Angle, $2\theta_{1/2}$ ^[2] (°)	Luminous Efficiency (lm/W)
		Typ.	Typ.	Typ.	Typ.
ASMT-JD30-ALN01	Deep Red	660	640	165	Not Applicable
ASMT-JR30-AST01	Red	635	625	165	79
ASMT-JH30-ARS01	Red Orange	625	615	165	65
ASMT-JA30-ARS01	Amber	598	590	165	65
ASMT-JG31-NUW01	Green	519	525	165	98
ASMT-JB31-NNP01	Blue	454	460	165	22
ASMT-JL31-NRS01	Royal Blue	450	455	165	Not Applicable

Electrical Characteristic at 350 mA (T_J = 25 °C)

Dice Type	Forward Voltage, V _F (V)			Thermal Resistance, R _{θj-ms} (°C/W) ^[1]
	Min.	Typ	Max.	Typ.
AllnGaP	1.7	2.1	2.3	9
InGaN	2.8	3.2	3.5	9

Note:

1. R_{θj-ms} is Thermal Resistance from LED junction to metal slug.

Optical and Electrical Characteristic at 700 mA (T_J = 25 °C)

Part Number	Color	Luminous Flux (lm) / Radiometric Power (mW), ϕ_V	Forward Voltage, V _F (V)
		Typ.	Typ.
ASMT-JD30-ALN01	Deep Red	480 mW	2.4
ASMT-JR30-AST01	Red	104.0	2.4
ASMT-JH30-ARS01	Red Orange	86.0	2.4
ASMT-JA30-ARS01	Amber	86.0	2.4
ASMT-JG31-NUW01	Green	176.0	3.6
ASMT-JB31-NNP01	Blue	43.0	3.6
ASMT-JL31-NRS01	Royal Blue	1020 mW	3.6

AlInGaP

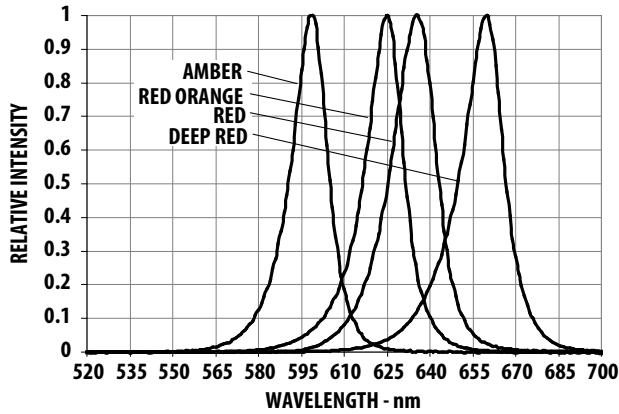

Figure 2. Relative Intensity vs. Wavelength for Deep Red, Red, Red Orange and Amber

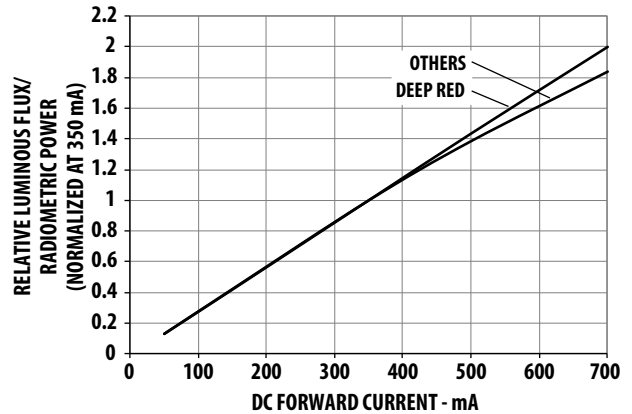

Figure 3. Relative Luminous Flux/ Radiometric Power vs. Mono Pulse Current

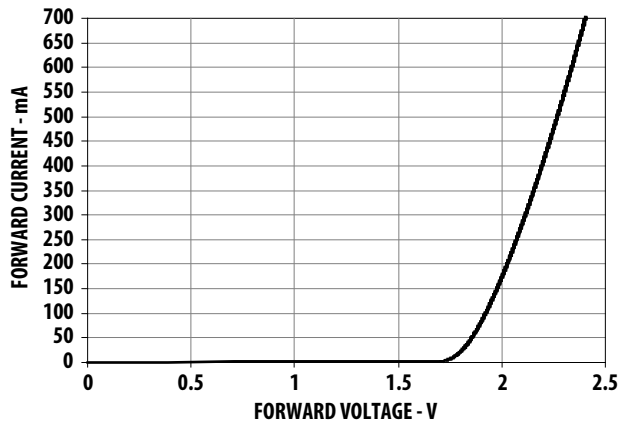

Figure 4. Forward Current vs. Forward Voltage

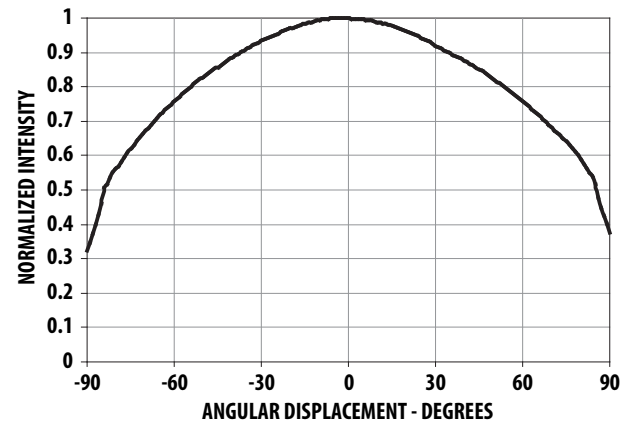

Figure 5. Radiation Pattern Deep Red, Red, Red Orange and Amber

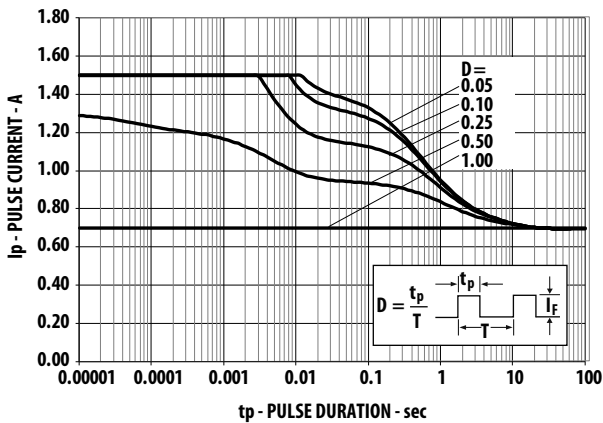

Figure 6. Maximum pulse current vs. ambient temperature. Derated based on $T_A = 25^\circ\text{C}$, $R_{\theta J-A} = 30^\circ\text{C/W}$.

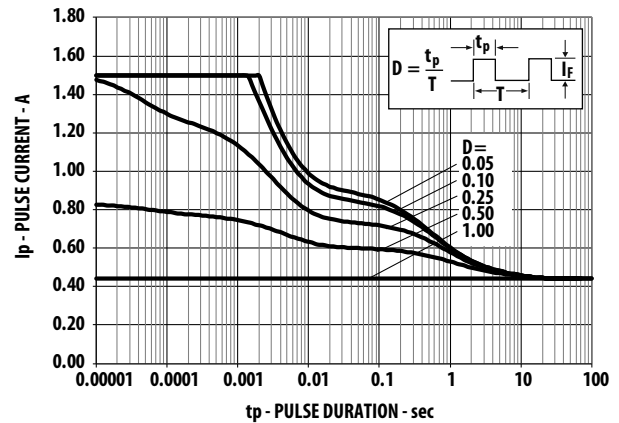

Figure 7. Maximum pulse current vs. ambient temperature. Derated based on $T_A = 85^\circ\text{C}$, $R_{\theta J-A} = 30^\circ\text{C/W}$.

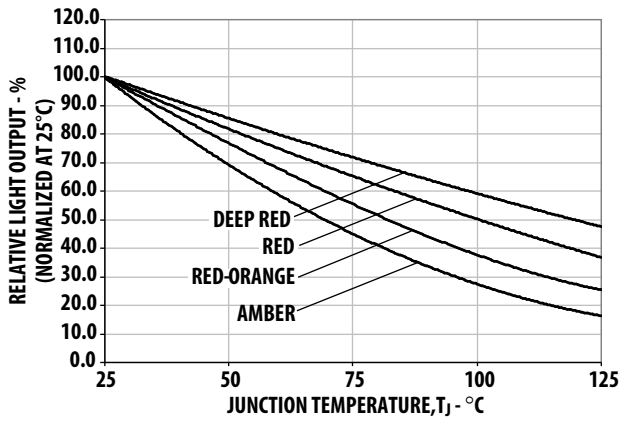

Figure 8. Relative Light Output vs. Junction Temperature

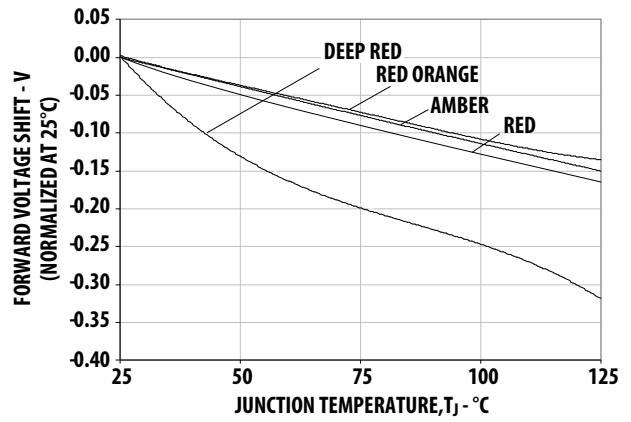

Figure 9. Forward Voltage Shift vs. Junction Temperature

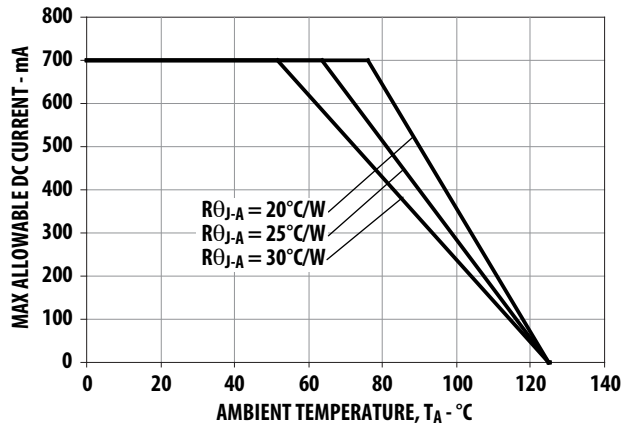

Figure 10. Maximum Forward Current vs. Ambient Temperature.
Derated based on $T_{JMAX} = 125^{\circ}C$, $R_{\theta JA} = 20^{\circ}C/W$, $25^{\circ}C/W$ and $30^{\circ}C/W$.

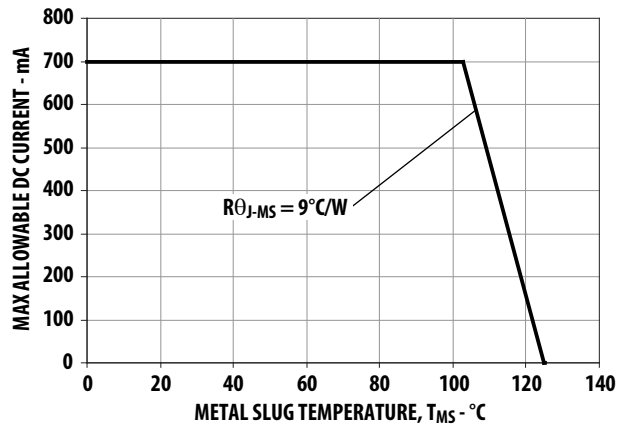

Figure 11. Maximum Forward Current vs. Ambient Temperature.
Derated based on $T_{JMAX} = 125^{\circ}C$, $R_{\theta JMS} = 9^{\circ}C/W$.

InGaN

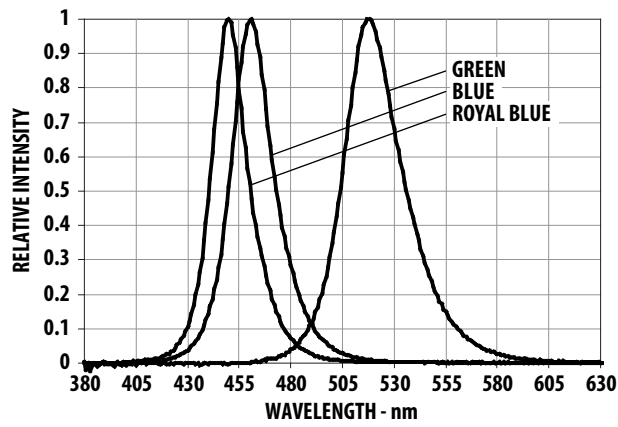

Figure 12. Relative Intensity vs. Wavelength for Blue and Green

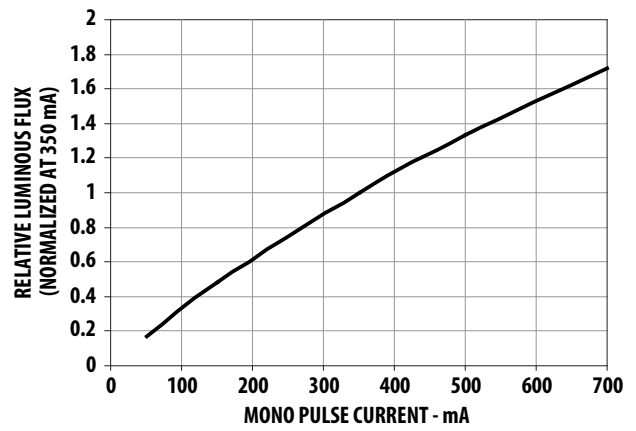

Figure 13. Relative Luminous Flux vs. Mono Pulse Current

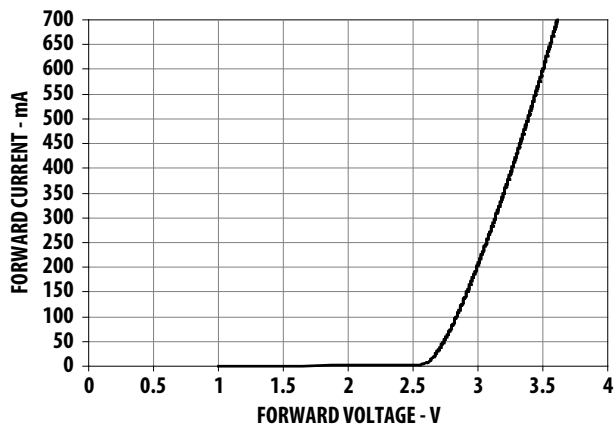

Figure 14. Forward Current vs. Forward Voltage

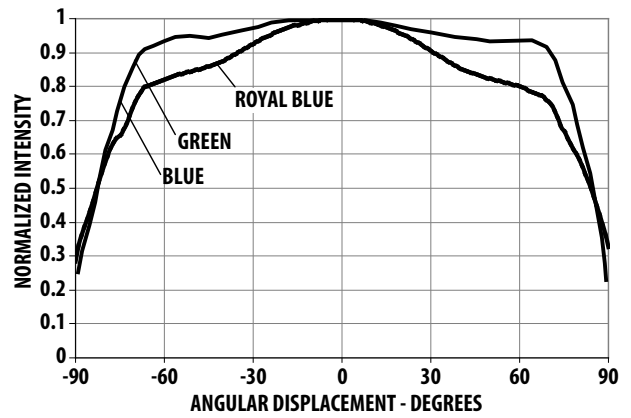

Figure 15. Radiation Pattern for Royal Blue, Blue and Green

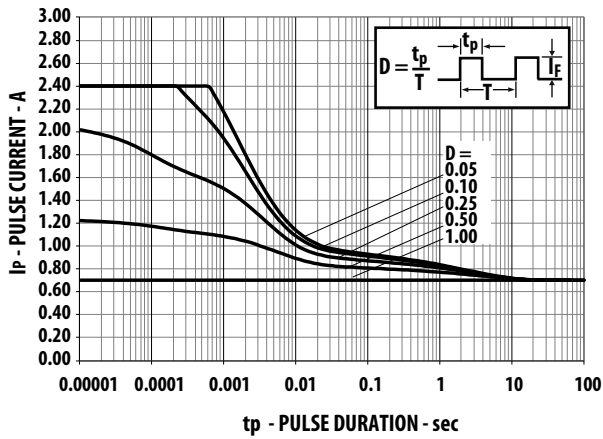

Figure 16. Maximum pulse current vs. ambient temperature.
Derated based on $T_A = 25\text{ }^\circ\text{C}$, $R_{\theta JA} = 30\text{ }^\circ\text{C/W}$

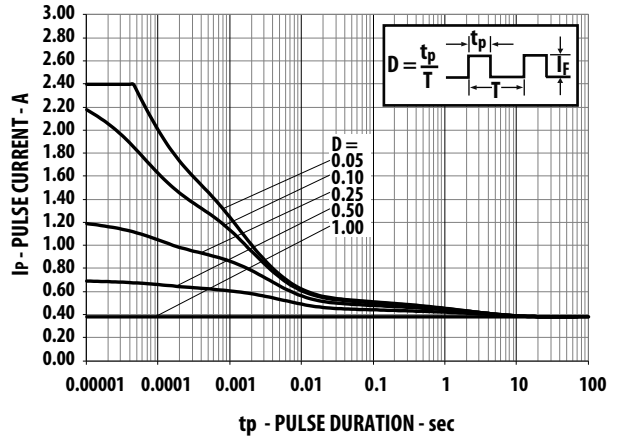

Figure 17. Maximum pulse current vs. ambient temperature.
Derated based on $T_A = 85\text{ }^\circ\text{C}$, $R_{\theta JA} = 30\text{ }^\circ\text{C/W}$

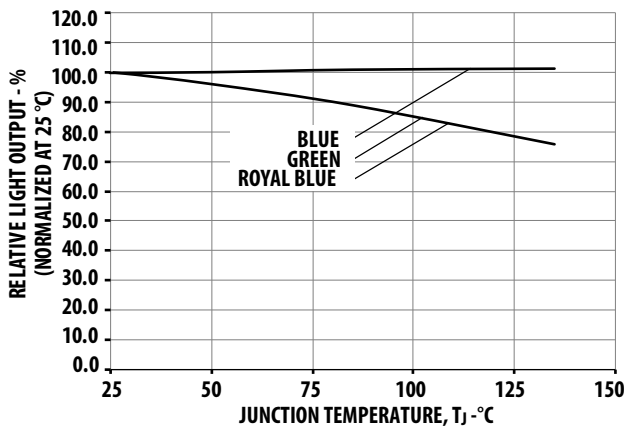

Figure 18. Relative Light Output vs. Junction Temperature

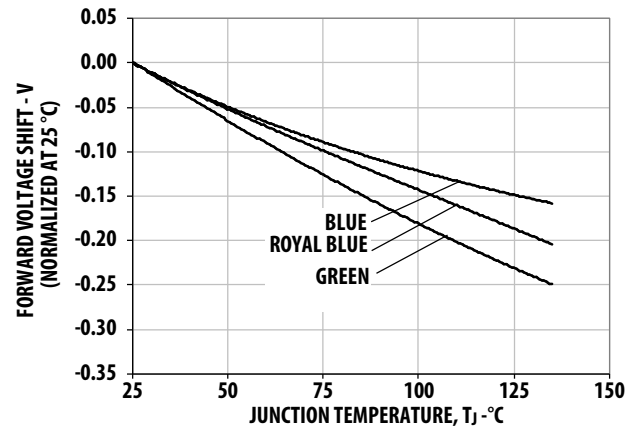

Figure 19. Forward Voltage Shift vs. Junction Temperature

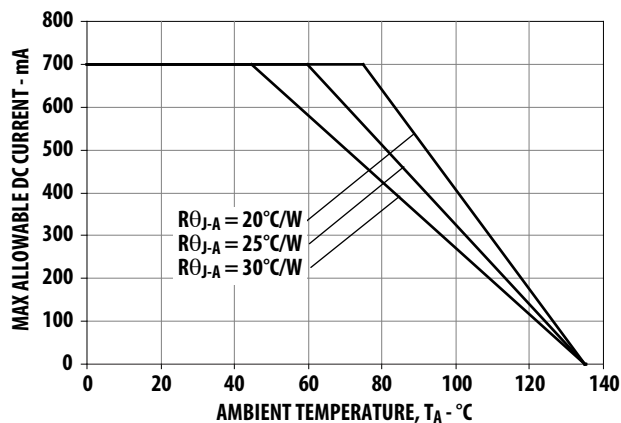

Figure 20. Maximum Forward Current vs. Ambient Temperature.
Derated based on $T_{JMAX} = 135\text{ }^\circ\text{C}$, $R_{\theta JA} = 20\text{ }^\circ\text{C/W}$, $25\text{ }^\circ\text{C/W}$ and $30\text{ }^\circ\text{C/W}$

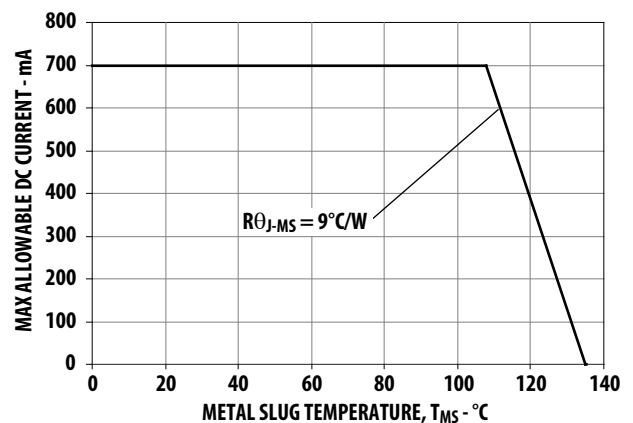

Figure 21. Maximum Forward Current vs. Metal Slug Temperature.
Derated based on $T_{JMAX} = 135\text{ }^\circ\text{C}$, $R_{\theta JMS} = 9\text{ }^\circ\text{C/W}$

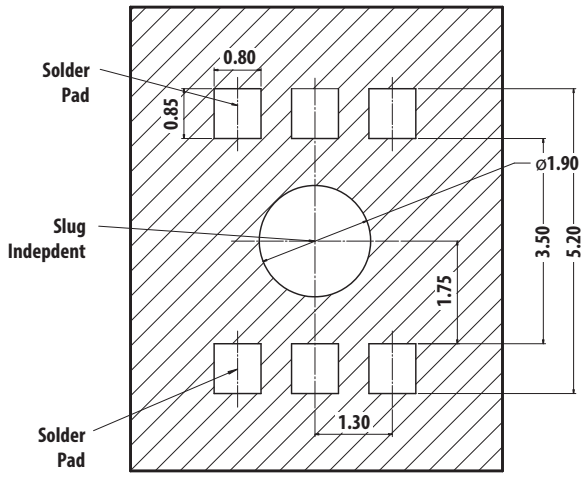

Figure 22. Recommended soldering land pattern

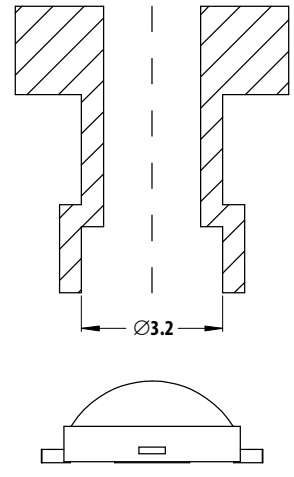

Figure 23. Recommended pick and place nozzle tip. Inner diameter = 3.2 mm

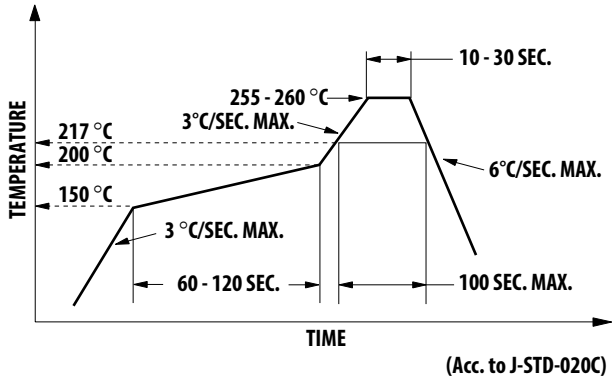

Figure 24. Recommended Reflow Soldering Profile

Note: For detailed information on reflow soldering of Avago surface mount LEDs, refer to Avago Application Note AN 1060 *Surface Mounting SMT LED Indicator Components*.

Option Selection Details

ASMT-J x₁ 3 x₂ – x₃ x₄ x₅ x₆ x₇

x₄ – Minimum Flux Bin Selection

x₅ – Maximum Flux Bin Selection

x₆ – Color Bin Selection

x₇ – Packaging Option

Color Bin Selection (x₆)

Individual reel will contain parts from one color bin selection only.

Selection	Bin ID
0	Full Distribution
Z	A and B
Y	B and C
W	C and D
V	D and E
Q	A, B and C
P	B, C and D
N	C, D and E
M	D, E and F

Color Bin Limits

Color	Bin ID	Dominant Wavelength (nm) at 350 mA	
		Min.	Max.
Red	–	620.0	635.0
Red Orange	–	610.0	620.0
Amber	B	587.0	589.5
	C	589.5	592.0
	D	592.0	594.5
	E	594.5	597.0
Blue	A	455.0	460.0
	B	460.0	465.0
	C	465.0	470.0
	D	470.0	475.0
Green	A	515.0	520.0
	B	520.0	525.0
	C	525.0	530.0
	D	530.0	535.0

Tolerance: ±1 nm

Packaging Option [x₇]

Selection	Option
1	Tape and Reel

Flux Bin Limit [x₄, x₅]

Color	Bin ID	Luminous Flux (lm)/ Radiometric Power (mW) at 350 mA	
		Min.	Max.
Blue	M	13.9	18.1
	N	18.1	23.5
	P	23.5	30.6
	Q	30.6	39.8
Other Colors	R	39.8	51.7
	S	51.7	67.2
	T	67.2	87.4
	U	87.4	99.6
	V	99.6	113.6
	W	113.6	129.5
	Deep Red and Royal Blue	L	175.0
M		225.0	275.0
N		275.0	355.0
P		355.0	435.0
Q		435.0	515.0
R		515.0	595.0
S		595.0	685.0

Tolerance for each bin limit is ± 10%

Color	Bin ID	Peak Wavelength (nm) at 350 mA	
		Min.	Max.
Deep Red	–	650.0	670.0
Royal Blue	C	440.0	445.0
	D	445.0	450.0
	E	450.0	455.0
	F	455.0	460.0

Tolerance: ± 2 nm

Example

ASMT-JG31-NST01

ASMT-JG31-Nxxxx – Green, InGaN, Electrically isolated Heat Sink

x₄ = S – Minimum Flux Bin S

x₅ = T – Maximum Flux Bin T

x₆ = 0 – Full Distribution

x₇ = 1 – Tape and Reel Option

Tape and Reel – Option 1

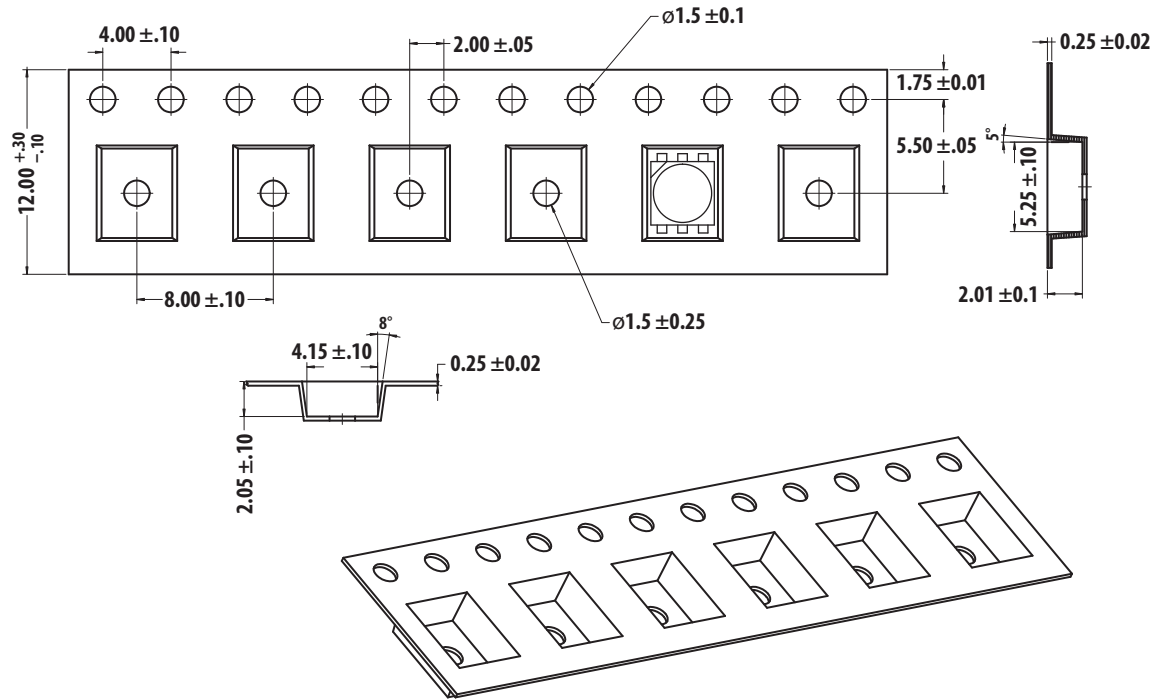
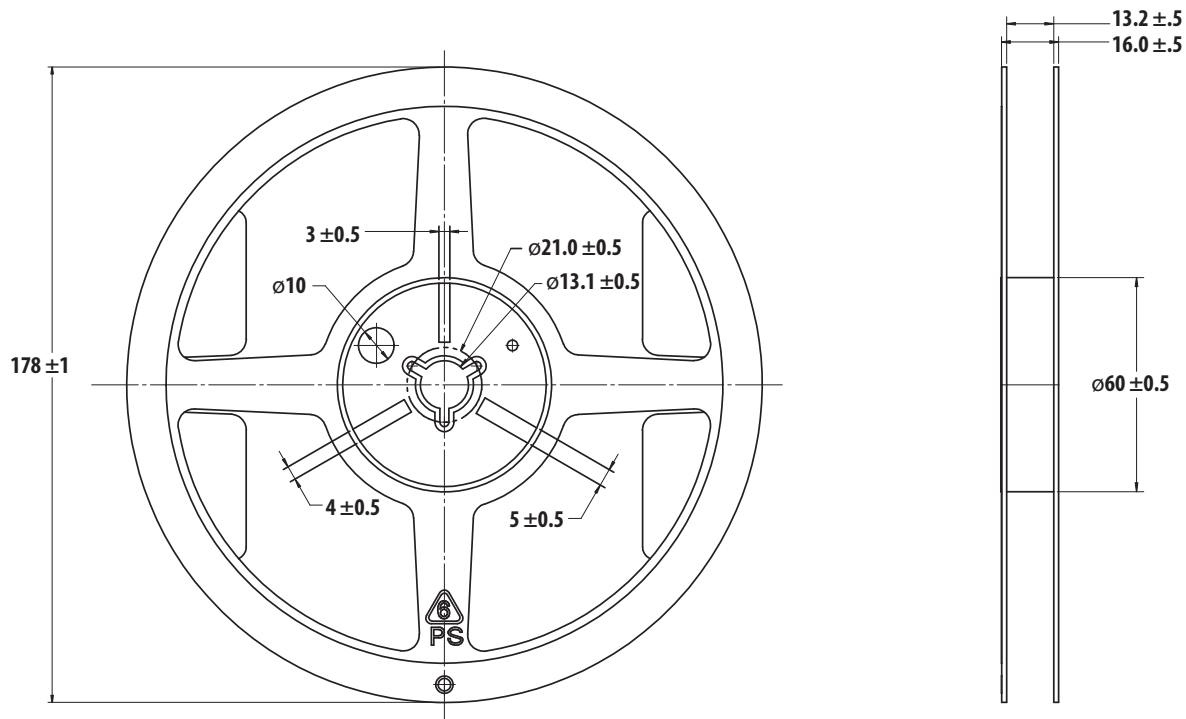

Figure 25. Carrier Tape Dimensions



Notes:

1. Empty component pockets sealed with top cover tape.
2. 250 or 500 pieces per reel.
3. Drawing not to scale.
4. All dimensions are in millimeters.

Figure 26. Reel dimensions

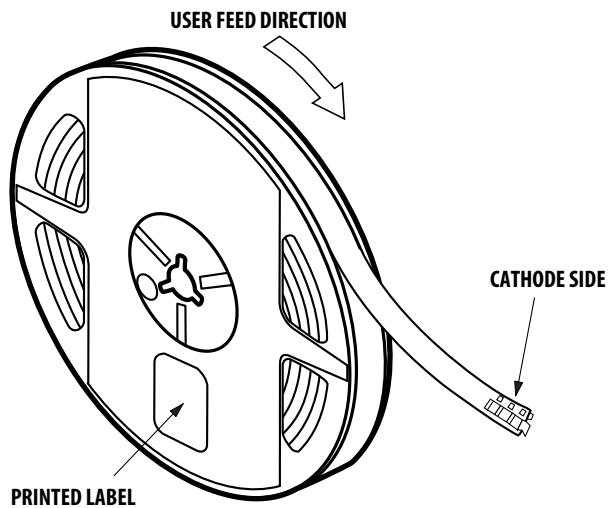

Figure 27. Reeling Orientation

DISCLAIMER: Avago's products and software are not specifically designed, manufactured or authorized for sale as parts, components or assemblies for the planning, construction, maintenance or direct operation of a nuclear facility or for use in medical devices or applications. Customer is solely responsible, and waives all rights to make claims against Avago or its suppliers, for all loss, damage, expense or liability in connection with such use.

For product information and a complete list of distributors, please go to our web site: www.avagotech.com

Avago, Avago Technologies, and the A logo are trademarks of Avago Technologies in the United States and other countries. Data subject to change. Copyright © 2005-2014 Avago Technologies. All rights reserved.
AV02-1941EN - December 1, 2014

AVAGO
TECHNOLOGIES

Mouser Electronics

Authorized Distributor

Click to View Pricing, Inventory, Delivery & Lifecycle Information:

Avago Technologies:

[ASMT-JR30-ARS01](#) [ASMT-JH30-ARS01](#) [ASMT-JA30-ARS01](#) [ASMT-JG31-NST01](#) [ASMT-JB31-NMP01](#) [ASMT-JL31-NPQ01](#) [ASMT-JW31-NTV01](#) [ASMT-JN31-NTV01](#) [ASMT-JY31-NSU01](#) [ASMT-JG31-NTU01](#) [ASMT-JD30-ALN01](#)
[ASMT-JB31-NNP01](#) [ASMT-JL31-NPR01](#) [ASMT-JW31-NUVH1](#) [ASMT-JW31-NUVJ1](#) [ASMT-JY31-NTU01](#) [ASMT-JY31-NTUJ1](#)

Broadcom Limited:

[ASMT-JH33-AST01](#) [ASMT-JR33-AST01](#)