

ALM-2412

GPS LNA-Filter Front-End Module



Data Sheet

Description

Avago Technologies' ALM-2412 is an LNA module, with integrated filter, designed for GPS band applications at 1.575GHz. The LNA uses Avago Technologies' proprietary GaAs Enhancement-mode pHEMT process to achieve high gain with very low noise figure and high linearity. Noise figure distribution is very tightly controlled. A CMOS-compatible shutdown pin is included either for turning the LNA on/off, or for current adjustment. The integrated filter utilizes an Avago Technologies' leading-edge FBAR filter for exceptional rejection at Cell/PCS-Band frequencies.

The ALM-2412 is useable down to 1V operation. It achieves low noise figure, high gain and linearity even at 1V, making it suitable for use in critical low-power GPS applications or during low-battery situations.

Component Image

Surface Mount 3.3x2.1x1.1 mm³ 12-lead MCOB

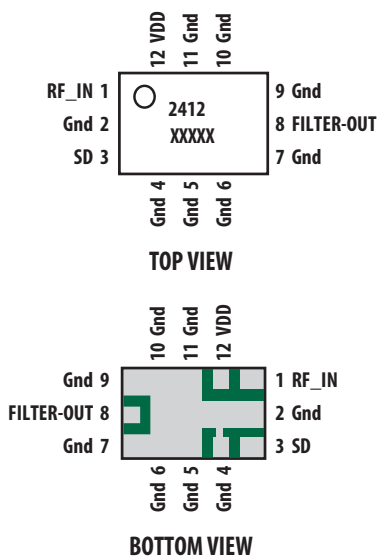

Note:
 Package marking provides orientation and identification
 "2412" = Product Code
 First "X" = Year of manufacture
 Second "X" = Work week of manufacture
 Third "X" = Datecode
 Fourth & Fifth "X" = Lot Number

Features

- Very Low Noise Figure : 0.85 dB typical
- High Gain : 13.5 dB typical
- High IIP3 and IP1dB
- Exceptional Cell/PCS-Band rejection
- Advanced GaAs E-pHEMT Technology
- Low external component count
- Wide Supply Voltage : 1V to 3.6V
- Shutdown current : < 0.1uA
- CMOS compatible shutdown pin (SD) current @ 2.8V : 0.1mA
- Adjustable current via single external resistor/voltage
- Meets MSL3, Lead-Free and Halogen-Free
- ESD-protected RF input: 3kV HBM
- Small package dimension: 3.3(L)x2.1(W)x1.1(H) mm³

Specifications (Typical performance at 25°C)

At 1.575GHz, Vdd = 2.85V, Idd = 9.0mA

- Gain = 13.5 dB
- NF = 0.85 dB
- IIP3 = +6.1 dBm, IP1dB = +2.2 dBm
- S11 = -8.4 dB, S22 = -9.0 dB
- Cell-Band Rejection: 53dBc
- PCS-Band Rejection: 65dBc

At 1.575GHz, 1.0V supply

- S21 = 7.2dB
- NF = 1.63dB
- Idd = 1.5mA

Application

- GPS Band LNA



Attention: Observe precautions for handling electrostatic sensitive devices.

For RF_IN (Pin 1): ESD Human Body Model = 3 kV

All other pins: ESD Machine Model = 40 V

ESD Human Body Model = 300 V

Refer to Avago Application Note A004R:

Electrostatic Discharge, Damage and Control.

Absolute Maximum Rating^[1] T_A=25°C

Symbol	Parameter	Units	Absolute Max.
V _{dd}	Device Drain to Source Voltage ^[2]	V	3.6
I _{dd}	Drain Current ^[2]	mA	20
P _{in,max}	CW RF Input Power (V _{dd} = 2.85V, I _{dd} =9.0mA)	dBm	15
P _{diss}	Total Power Dissipation ^[4]	mW	72
T _j	Junction Temperature	°C	150
T _{STG}	Storage Temperature	°C	-65 to 150
T	Recommended Operating Temperature	°C	-40 to 85

Thermal Resistance

Thermal Resistance^[3]
(V_{dd} = 2.85 V, I_{dd} = 9.0 mA), θ_{jc} = 352.2°C/W

Notes:

1. Operation of this device in excess of any of these limits may cause permanent damage.
2. Assuming DC quiescent conditions
3. Thermal resistance measured using Infra-Red measurement technique.
4. Board (module belly) temperature T_B is 25°C. Derate 2.84 mW/°C for T_B>125°C.

Electrical Specifications

T_A = 25°C, V_{dd} = +2.85V, V_{sd} = +2.6V, I_{dd} = 9.0mA (typ), R₂ = 10 kΩ, Freq = 1.575GHz – Typical Performance ^[8] unless otherwise specified.

Table 1. Performance table at nominal operating conditions

Symbol	Parameter and Test Condition	Units	Min.	Typ	Max.
G	Gain	dB	11	13.5	-
NF ^[7]	Noise Figure	dB	-	0.85	1.20
IP1dB	Input 1dB Compressed Power	dBm	-	2.2	-
IIP3 ^[9]	Input 3 rd Order Intercept Point (2-tone @ Fc +/- 2.5MHz)	dBm	-	6.1	-
S11	Input Return Loss	dB	-	-8.4	-
S22	Output Return Loss	dB	-	-9.0	-
S12	Reverse Isolation	dB	-	-21.6	-
Cell Band Rejection	Relative to 1.575GHz @ 827.5MHz	dBc	45	53	-
PCS Band Rejection	Relative to 1.575GHz @ 1885MHz	dBc	45	65	-
I _{dd}	Supply DC current at Shutdown (SD) voltage V _{sd} = 2.6V	mA	-	9.0	15.0
I _{sh}	Shutdown Current @ V _{SD} = 0V	uA	-	0.1	-

T_A = 25°C, V_{dd} = +2.85V, V_{sd} = +1.8V, I_{dd} = 3.2mA (typ), R₂ = 10 kΩ, Freq = 1.575GHz – Typical Performance ^[8] unless otherwise specified.

Table 2. Typical performance at V_{dd} = +2.85V, V_{sd} = +1.8V, I_{dd} = 3.2mA (typ)

Symbol	Parameter and Test Condition	Units	Typ
G	Gain	dB	11.5
NF ^[7]	Noise Figure	dB	1.1
IP1dB	Input 1dB Compressed Power	dBm	4.4
IIP3 ^[9]	Input 3 rd Order Intercept Point (2-tone @ Fc +/- 2.5MHz)	dBm	5.3
S11	Input Return Loss	dB	-6.8
S22	Output Return Loss	dB	-8.6
S12	Reverse Isolation	dB	-20.4
Cell Band Rejection	Relative to 1.575GHz @ 827.5MHz	dBc	56
PCS Band Rejection	Relative to 1.575GHz @ 1885MHz	dBc	62
I _{dd}	Supply DC current at Shutdown (SD) voltage V _{sd} = 1.8V	mA	3.2
I _{sh}	Shutdown Current @ V _{SD} = 0V	uA	0.1

Vdd = +2V, Vdd = +1.5V, Vdd = +1V, Freq = 1.575GHz – Typical Performance^[8] (Vsd = Vdd, R2 = 0 ohms)

Table 3. Typical performance at low operating voltages with R2 (see Figures 6 and 7) set to 0 ohms

Symbol	Parameter and Test Condition	Units	Vdd = 2V	Vdd = 1.5V	Vdd = 1V
G	Gain	dB	12.6	11	7.2
NF ^[7]	Noise Figure	dB	0.8	1	1.6
IP1dB	Input 1dB Compressed Power	dBm	-0.7	-1.6	-0.7
IIP3 ^[9]	Input 3 rd Order Intercept Point (2-tone @ Fc +/- 2.5MHz)	dBm	6	4.3	3
S11	Input Return Loss	dB	-8.2	-7.4	-5.2
S22	Output Return Loss	dB	-12.9	-11	-7
S12	Reverse Isolation	dB	-21.6	-20.1	-16.9
Cell Band Rejection	Relative to 1.575GHz @ 827.5MHz	dBc	54.7	55.7	57.6
PCS Band Rejection	Relative to 1.575GHz @ 1885MHz	dBc	63.7	62.9	61.9
Idd	Supply DC current	mA	7.7	4.1	1.3
Ish	Shutdown Current @ VSD = 0V	uA	0.1	0.1	0.1

Notes:

7. For noise figure measurement, input board loss has not been deducted

8. Measurements at 1.575GHz obtained using demo board described in Figures 6 and 7

9. 1.575GHz IIP3 test condition: $F_{RF1} = 1572.5$ MHz, $F_{RF2} = 1577.5$ MHz with input power of -20dBm per tone measured at the worst case side band

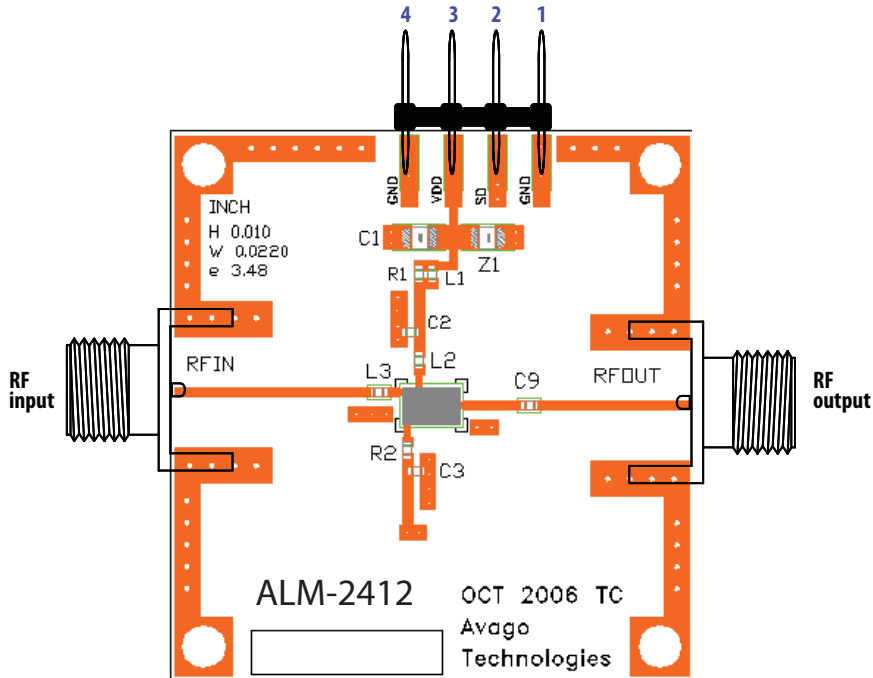

DC Pin Configuration of 4-pin Connector

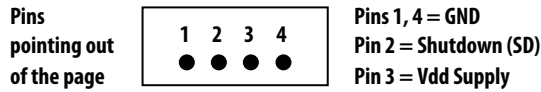

Circuit Symbol	Size	Description
L1	0402	Not Used
L2	0402	6.8 nH Inductor (Toko)
L3	0402	5.6 nH Inductor (Toko)
C1	0805	0.1 uF Capacitor (Murata)
C2	0402	10 pF Capacitor (Rohm)
C3	0402	6.8 pF Capacitor (Rohm)
C9	0402	100pF Capacitor (Rohm)
R1	0402	12 Ohms Resistor (Rohm)
R2	0402	10k Ohms Resistor (Rohm)
Z1	0805	Not Used

Figure 1. Demoboard and application circuit components table

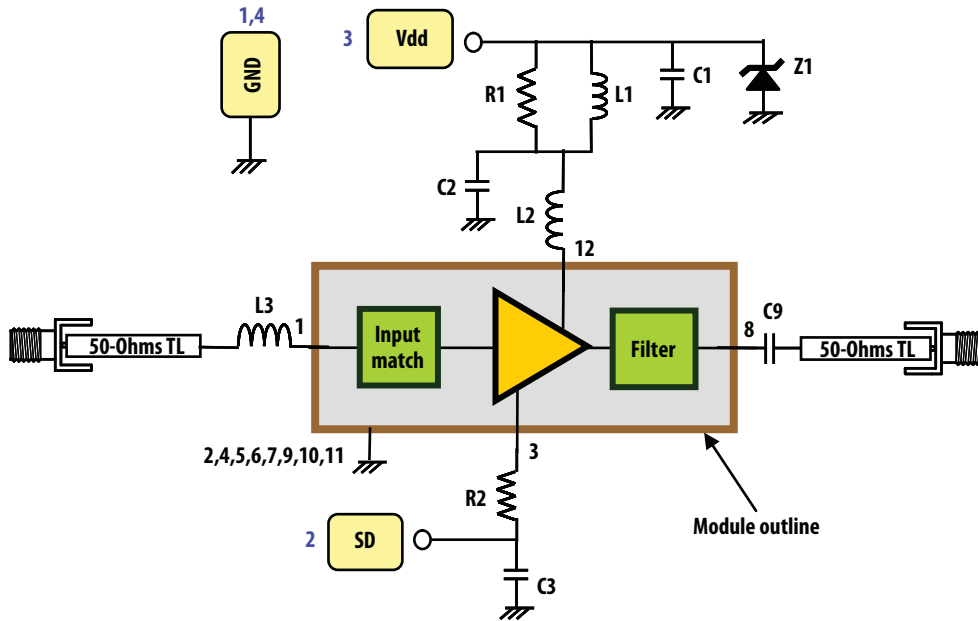

Figure 2. Demoboard and application schematic diagram

Notes:

- The demoboard of Figure 6 is Rogers® RO4350 with typical $Dk = 3.48$ (@10GHz).
- L3 and the module's internal input pre-match form the input matching network. The module has built-in DC-blocking capacitors at the input and output.
- This circuit demonstrates that very low noise figure is obtainable with standard 0402 chip inductors instead of high-Q wirewound inductors.
- C2 and L2 form a matching network at the output of the LNA stage, which can be tuned to optimize gain and return loss. For example, higher gain can be obtained by increasing the value of C2 but at the expense of stability. Changing the value of L2 can improve the PCS rejection, but impacts output return loss.
- L1 is a choke which isolates the demoboard from external disturbances during measurement. It is not needed in actual application. Likewise, C1 and C3 mitigate the effect of external noise pickup on the Vdd and SD lines respectively. These components are not required in actual operation.
- R1 is a stability-enhancing resistor.
- C9 is a DC-blocking capacitor. It is also not required in actual operation.
- Bias control is achieved by either varying the SD voltage with/ without R2, or fixing the SD voltage to Vdd and adjusting R2 for the desired current. Typical value for R2 is 10k Ohms for 9mA total current at $V_{dd} = 2.85V$ and $V_{sd} = +2.60V$. For applications where it is more appropriate to have SD (Vsd) connected to Vdd, an 18k Ohms resistor value for R2 is suggested (where $V_{dd} = 2.85V$).
- For low-voltage operation such as $V_{dd} = 1.5V$ or $1.0V$, R2 may be omitted and SD (Vsd) connected directly to Vdd.
- The grounding regime for the ALM-2412 is critical to achieving the PCS- and Cell-Band Rejections shown in Figure 9. Please refer to the PCB Land Patterns section of this document for the exact locations of the grounding vias.

ALM-2412 Typical Performance Curves, Vdd = +2.85V, Idd = 6.2mA (At 25°C unless specified otherwise)

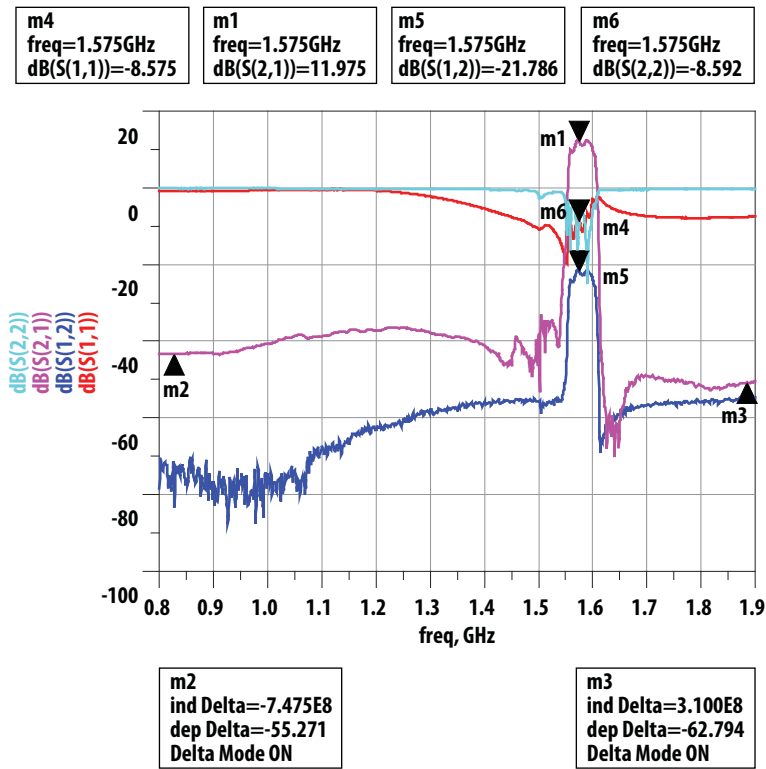

Figure 3. Typical S-Parameter plot

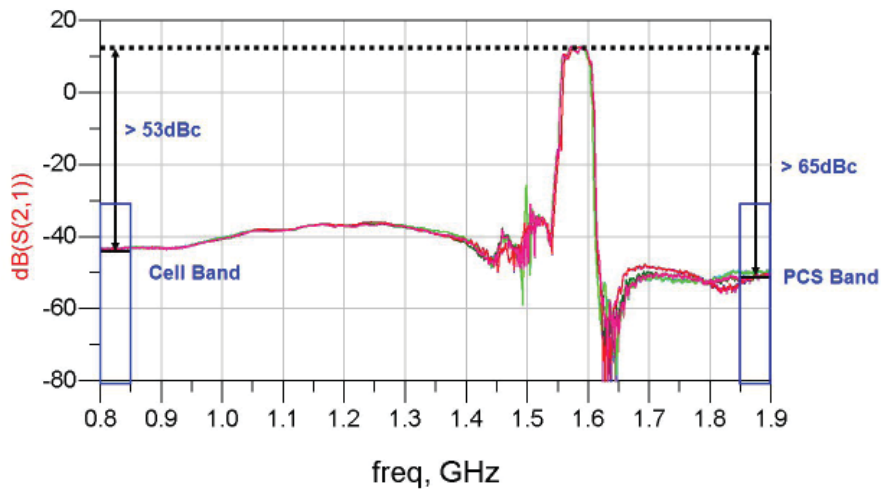

Figure 4. Multiple module plots of rejection at Cell and PCS Bands

ALM-2412 Typical Performance Curves, R1 = 10k ohms (At 25°C unless specified otherwise)

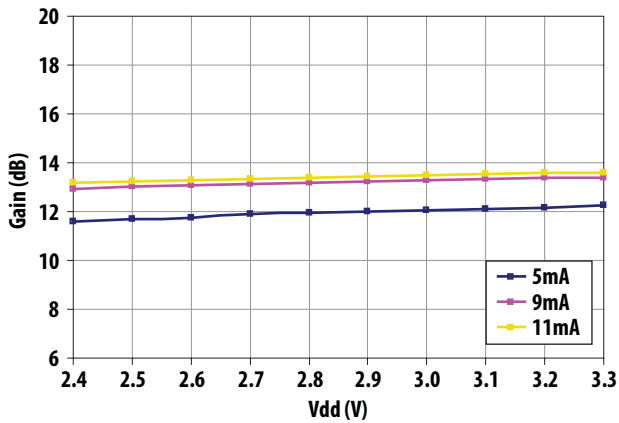

Figure 5. Gain Vs Vdd Vs Idd

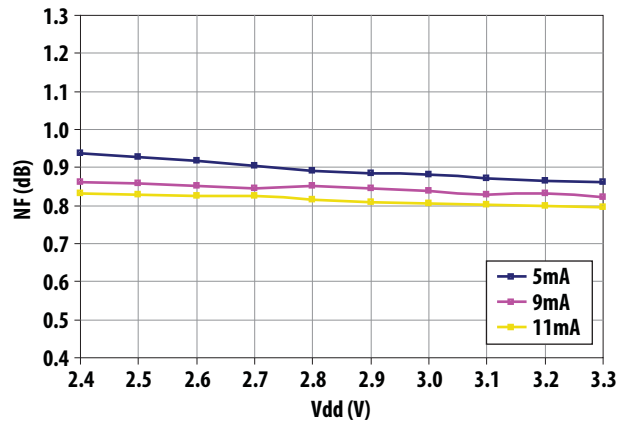

Figure 6. NF Vs Vdd Vs Idd

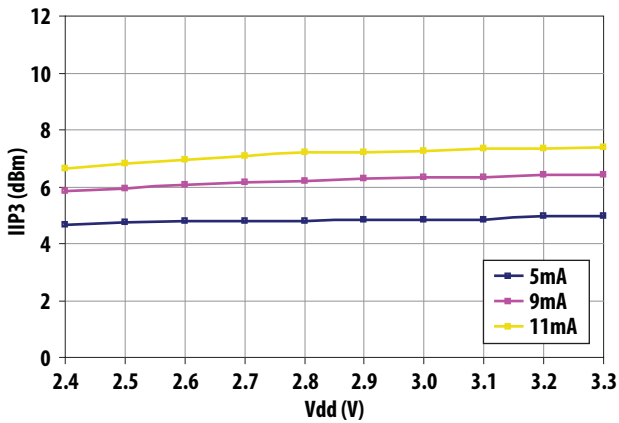

Figure 7. IIP3 Vs Vdd Vs Idd

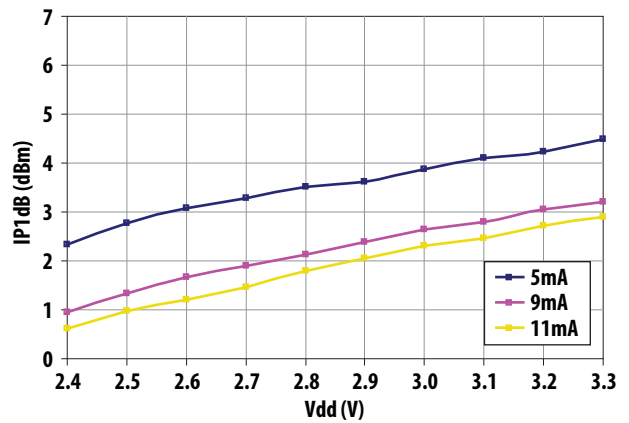

Figure 8. IP1dB Vs Vdd Vs Idd

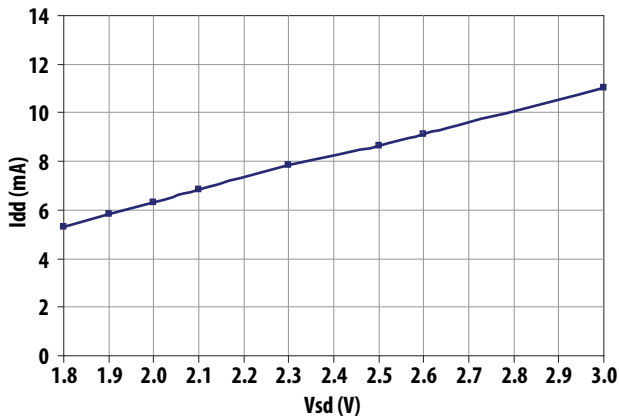

Figure 9. Idd Vs Vsd (Vdd=2.85V)

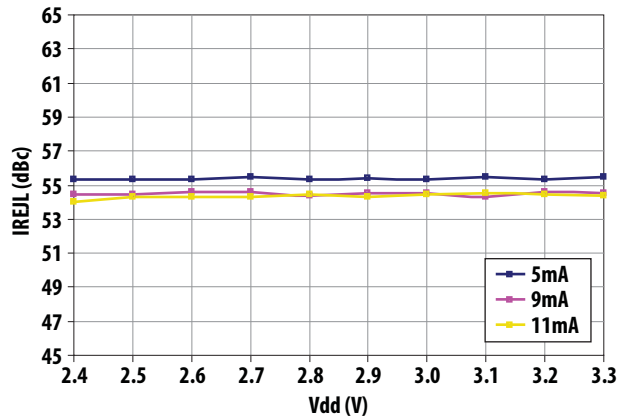

Figure 10. Cell band rejection Vs Vdd Vs Idd

ALM-2412 Typical Performance Curves, R1=10k ohms (At 25°C unless specified otherwise)

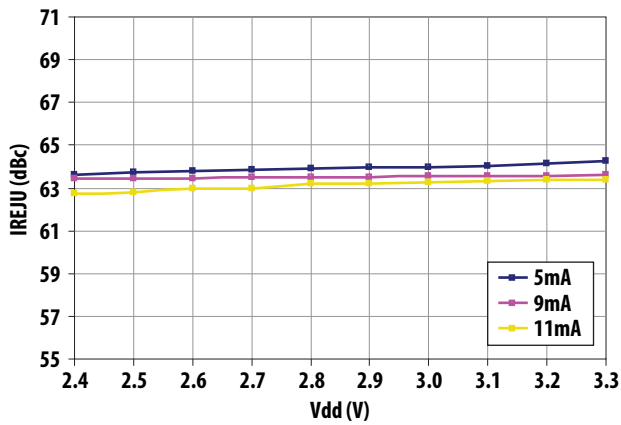

Figure 11. PCS band rejection Vs Vdd Vs Idd

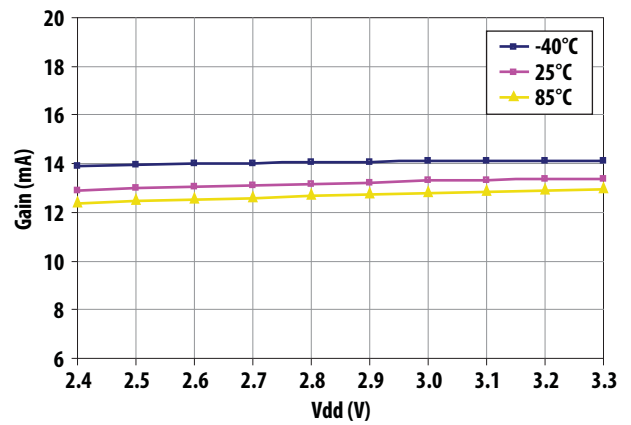

Figure 12. Gain Vs Vdd Vs Temp (Idd=9mA)

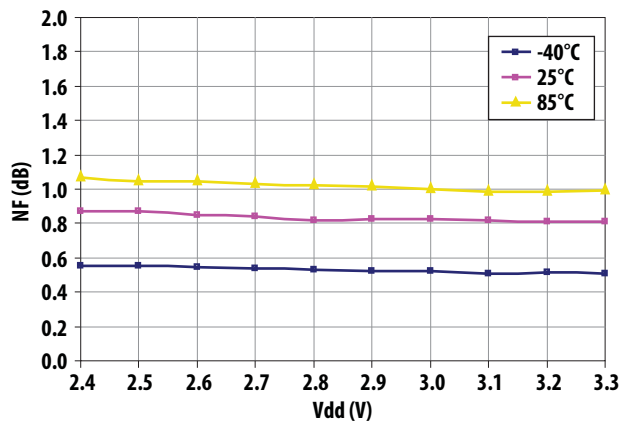

Figure 13. NF Vs Vdd Vs Temp (Idd=9mA)

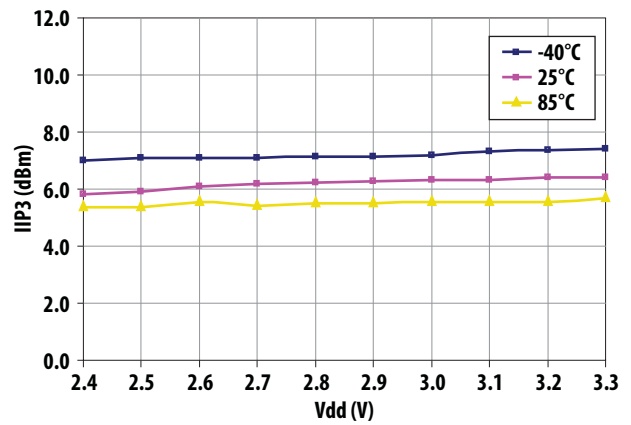

Figure 14. IIP3 Vs Vdd Vs Temp (Idd=9mA)

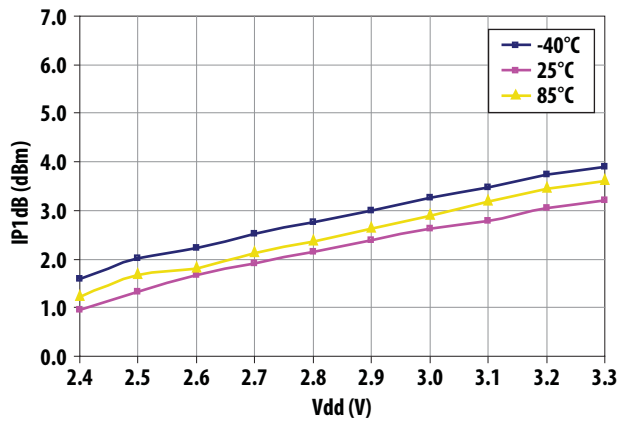

Figure 15. IP1dB Vs Vdd Vs Temp (Idd=9mA)

ALM-2412 Typical Performance Curves, R1 = 10k ohms (At 25°C unless specified otherwise)

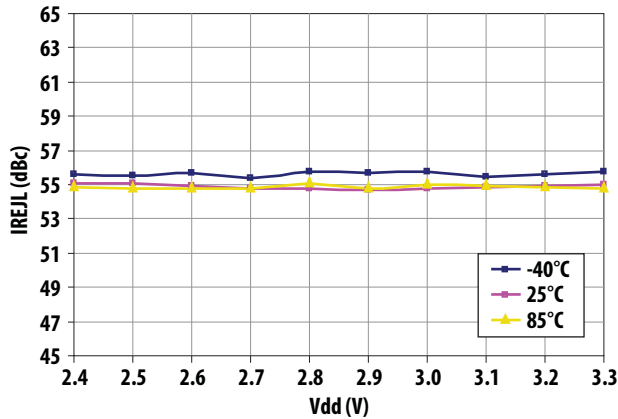

Figure 16. Cell band rejection Vs Vdd Vs Temp (Idd=9mA)

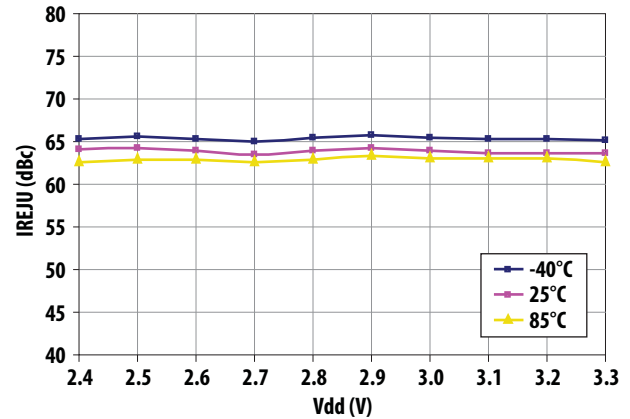

Figure 17. PCS band rejection Vs Vdd Vs Temp (Idd=9mA)

ALM-2412 Typical Scattering Parameters at 25°C, Vdd = 2.85V, Idd = 9.0 mA

The S- and Noise Parameters are measured using the PCB described in Figures 6 and 7. The PCB material is 10 mils Rogers® RO4350. Figure 23 shows the input and output reference planes. The circuit values, with the exception of L3, are as indicated in Figure 6.

Freq (GHz)	S11 (Mag)	S11 (Ang)	S21 (dB)	S21 (Mag)	S21 (Ang)	S12 (dB)	S12 (Ang)	S22 (Mag)	S22 (Ang)
0.3	0.9500	24.3080	-53.0103	0.0022	-64.3603	-83.4472	2.2928	0.9983	-38.2983
0.5	0.9810	-26.9915	-45.0767	0.0056	-101.7629	-72.7369	99.2046	0.9940	-63.9345
0.7	0.9574	-68.9018	-41.5411	0.0084	-144.0420	-71.2519	62.3471	0.9949	-88.9346
0.8	0.9309	-88.2339	-41.2477	0.0087	-160.1246	-75.4796	-10.3220	0.9843	-101.9066
0.8275	0.9252	-93.3423	-41.1302	0.0088	-160.2805	-77.8045	38.2306	0.9856	-105.4838
0.9	0.9177	-106.9481	-40.5723	0.0094	-172.7013	-79.0652	53.4588	0.9891	-114.5814
1	0.9250	-127.8097	-39.5941	0.0105	-176.9576	-76.2791	106.0042	0.9832	-127.2962
1.1	0.9353	-152.9168	-37.2798	0.0137	165.3683	-69.8529	145.2438	0.9754	-140.4467
1.2	0.9158	174.7925	-35.7549	0.0163	143.4377	-63.9935	128.3283	0.9802	-153.4140
1.3	0.7946	134.3360	-37.5214	0.0133	130.8836	-59.1849	111.7022	0.9706	-167.1344
1.4	0.5885	90.9147	-41.8159	0.0081	91.2687	-56.9362	73.8568	0.9634	177.1917
1.5	0.3586	51.1412	-40.0352	0.0100	169.4231	-55.0038	48.7376	0.8535	150.1499
1.575	0.3735	84.3481	13.5499	4.7588	90.4620	-22.3019	43.2091	0.2586	-12.6662
1.6	0.7476	65.6530	11.1269	3.6003	143.9489	-24.7551	91.0611	0.5585	-115.7049
1.7	0.4936	-18.1639	-49.2624	0.0034	48.9582	-56.9992	33.3754	0.9617	160.2494
1.8	0.4779	-46.7353	-55.2772	0.0017	75.0639	-55.9405	22.7742	0.9607	143.4297
1.885	0.4917	-65.8114	-48.8096	0.0036	118.6825	-55.2593	14.4221	0.9519	131.2363
1.9	0.4964	-68.7818	-47.9441	0.0040	118.5708	-55.2112	9.3947	0.9526	129.1638
2	0.5236	-87.1166	-43.6491	0.0066	116.3684	-54.2886	-2.7401	0.9544	116.1047
2.1	0.5578	-102.8903	-41.0295	0.0089	104.5683	-54.5318	-8.6652	0.9483	103.3151
2.2	0.5893	-117.1373	-39.2482	0.0109	93.1084	-53.6690	-18.1018	0.9440	90.2622
2.3	0.6208	-130.1776	-38.9962	0.0112	79.8502	-53.6796	-28.8668	0.9474	77.8684
2.4	0.6508	-142.4117	-37.8263	0.0128	66.6074	-53.4105	-37.4890	0.9366	64.5382
2.5	0.6799	-154.1330	-37.9962	0.0126	52.4394	-52.7064	-49.4043	0.9362	51.2358
3	0.7949	152.7103	-64.9944	0.0006	55.6408	-53.0296	-115.4632	0.8899	-21.9066
3.5	0.8681	105.4590	-23.9865	0.0632	79.4316	-50.5228	96.7559	0.7839	-128.2725
4	0.9137	61.2580	-15.5361	0.1672	-31.2094	-37.9448	-49.3136	0.6408	50.7479
4.5	0.9380	18.9691	-15.1307	0.1752	-135.1450	-35.0746	-143.1255	0.6172	-110.1415
5	0.9505	-22.2529	-17.3940	0.1350	147.3349	-35.9246	137.3279	0.6552	124.4230
5.5	0.9528	-63.5553	-21.1722	0.0874	70.6993	-38.2030	73.6058	0.6872	27.3421
6	0.9495	-105.3280	-29.2697	0.0344	45.4125	-41.7965	64.5211	0.6352	-19.4748

ALM-2412 Scattering Parameter and Noise Parameter Measurement

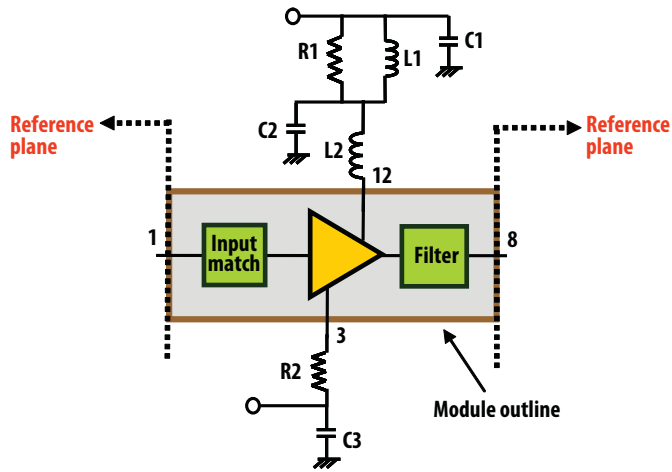

Figure 18. Scattering and Noise Parameter reference planes

ALM-2412 Typical Scattering Parameters at 25°C, V_{dd} = 2.85V, I_{dd} = 3.2 mA

Freq (GHz)	S11 (Mag)	S11 (Ang)	S21 (dB)	S21 (Mag)	S21 (Ang)	S12 (dB)	S12 (Ang)	S22 (Mag)	S22 (Ang)
0.3	0.9437	25.1842	-56.6250	0.0015	-56.2045	-76.3685	125.4973	0.9982	-38.2854
0.5	0.9793	-24.9837	-47.6772	0.0041	-98.4688	-75.2131	89.0743	0.9942	-63.9061
0.7	0.9710	-65.7032	-43.9381	0.0064	-136.0755	-72.7917	56.1160	0.9951	-88.9240
0.8	0.9534	-84.5781	-43.5064	0.0067	-152.0264	-75.3778	65.0142	0.9845	-101.8883
0.8275	0.9506	-89.6180	-43.6122	0.0066	-152.6773	-70.6928	85.4300	0.9857	-105.5005
0.9	0.9480	-102.9481	-42.6842	0.0073	-166.1491	-76.3508	26.7945	0.9891	-114.5563
1	0.9622	-123.0758	-41.4344	0.0085	-168.6170	-76.5894	116.5373	0.9835	-127.2816
1.1	0.9832	-147.1698	-38.8120	0.0115	173.8790	-73.2556	118.9165	0.9752	-140.4388
1.2	0.9756	-178.5820	-36.8148	0.0144	151.5848	-64.1740	132.9518	0.9804	-153.3940
1.3	0.8282	141.3595	-38.1281	0.0124	135.7789	-59.4834	110.0181	0.9709	-167.1206
1.4	0.5570	101.1569	-42.6142	0.0074	90.8719	-56.8034	78.1796	0.9634	177.2173
1.5	0.3014	75.0549	-41.2422	0.0087	170.7122	-55.3660	54.0700	0.8547	150.1649
1.575	0.4579	99.1677	12.0288	3.9943	95.4837	-21.0892	39.1122	0.3290	-4.5519
1.6	0.8078	76.1104	10.2399	3.2508	152.0063	-22.7890	90.5229	0.5356	-120.2133
1.7	0.3858	-6.8862	-49.8007	0.0032	49.0105	-57.1647	42.5100	0.9622	160.2686
1.8	0.3640	-34.6496	-55.4610	0.0017	74.5288	-55.9648	25.6484	0.9608	143.4563
1.885	0.3845	-53.6204	-49.4320	0.0034	112.4398	-55.0812	18.6501	0.9519	131.2389
1.9	0.3902	-56.6177	-48.7844	0.0036	115.2951	-54.9790	12.9813	0.9526	129.1710
2	0.4330	-74.9590	-44.8367	0.0057	111.2168	-54.1082	7.2474	0.9548	116.1177
2.1	0.4870	-91.2581	-42.0224	0.0079	98.7025	-54.1145	-2.0907	0.9486	103.3151
2.2	0.5407	-106.4211	-40.6064	0.0093	86.8407	-52.6911	-12.1006	0.9440	90.2799
2.3	0.5913	-120.6560	-40.3220	0.0096	73.8261	-51.9861	-24.9929	0.9481	77.8880
2.4	0.6376	-134.1556	-39.2032	0.0110	58.9540	-52.2734	-35.5332	0.9365	64.5526
2.5	0.6797	-147.0601	-39.5911	0.0105	44.5045	-51.5403	-47.2899	0.9366	51.2631
3	0.8218	155.3244	-73.9981	0.0002	-66.0550	-52.5626	-113.4427	0.8903	-21.8880
3.5	0.8905	106.0429	-26.4816	0.0474	79.2320	-52.8246	91.8748	0.7844	-128.2450
4	0.9252	61.1667	-17.8927	0.1275	-28.8321	-39.3233	-54.1066	0.6473	50.3538
4.5	0.9426	18.8015	-17.1918	0.1382	-130.6277	-36.4301	-144.6187	0.6257	-111.6124
5	0.9522	-22.3400	-19.0379	0.1117	152.7274	-36.9603	138.6193	0.6557	122.4208
5.5	0.9528	-63.5735	-22.3934	0.0759	75.7488	-38.8835	75.7347	0.6692	25.7070
6	0.9495	-105.3228	-30.1215	0.0312	50.3551	-41.9579	64.9560	0.6153	-20.4365

**ALM-2412 Typical Noise Parameter at 25°C,
Freq = 1.575GHz, Vdd = 2.85V, Idd = 9mA**

Freq	Fmin	GAMMA OPT		
		Mag	Ang	Rn/50
(GHz)	(dB)			
1.575	0.7	0.55	62	0.36

Part Number Ordering Information

Part Number	No. of Devices	Container
ALM-2412-BLKG	100	Antistatic Bag
ALM-2412-TR1G	3000	13" Reel

Notes:

- The exceptional noise figure performance of the ALM-2412 is due to its highly optimized design. In this regard, the Fmin of the ALM-2412 shown above is locked down by the internal input pre-match. This allows the use of relatively inexpensive chip inductors for external matching.
- The NF performance of the ALM-2412 is also very resilient to operating conditions. For example, at Idd = 5mA, the degradation in NF is only 0.1dB, and not more than 0.15dB degradation over temperature.

Package Dimensions

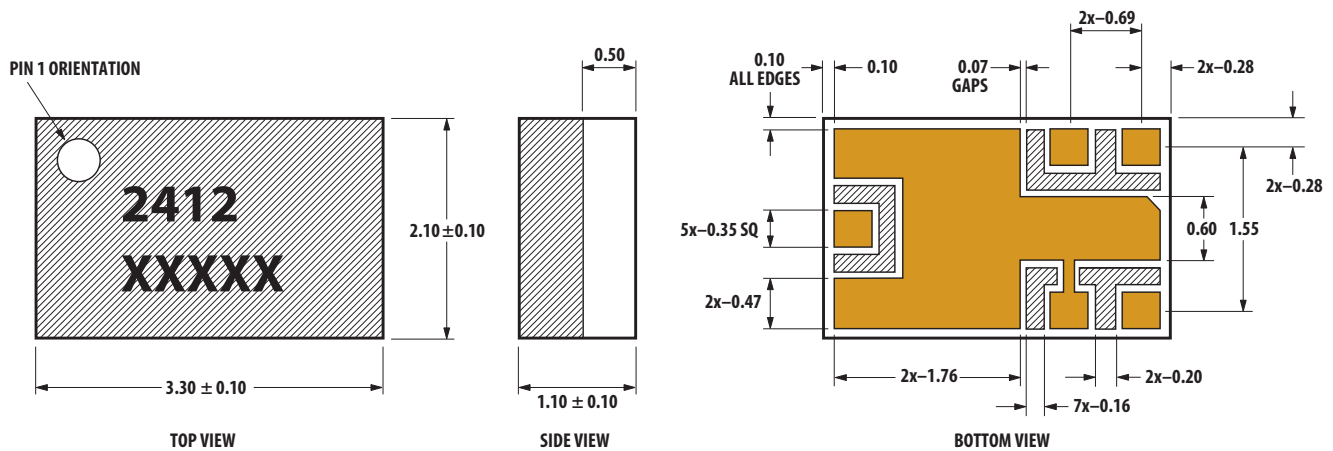

NOTES:

- ALL DIMENSIONS ARE IN MILLIMETERS.
- DIMENSIONS ARE INCLUSIVE OF PLATING.
- DIMENSIONS ARE EXCLUSIVE OF MOLD FLASH AND METAL BURR.

PCB Land Patterns and Stencil Design

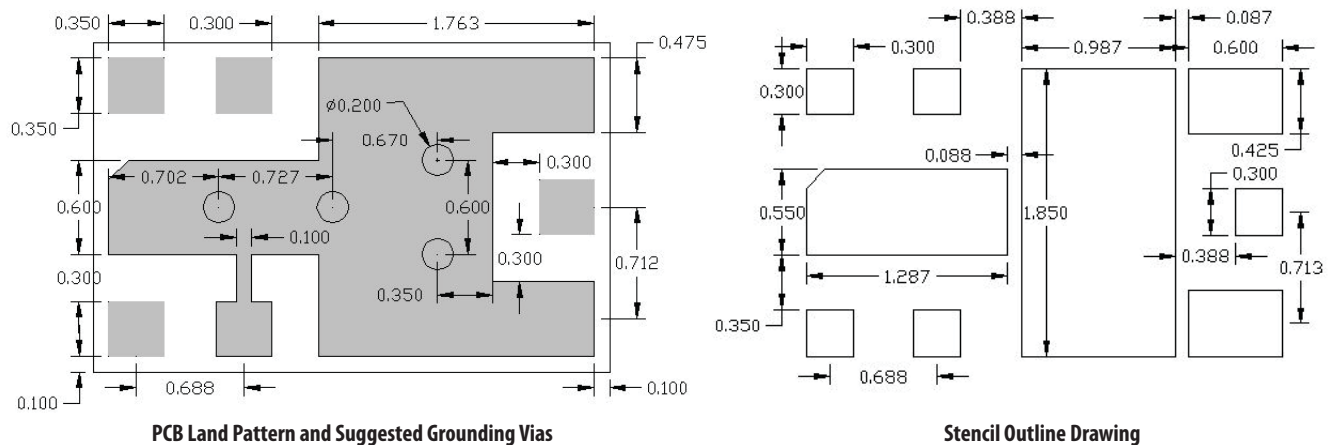

Dimensions are in mm

Device Orientation

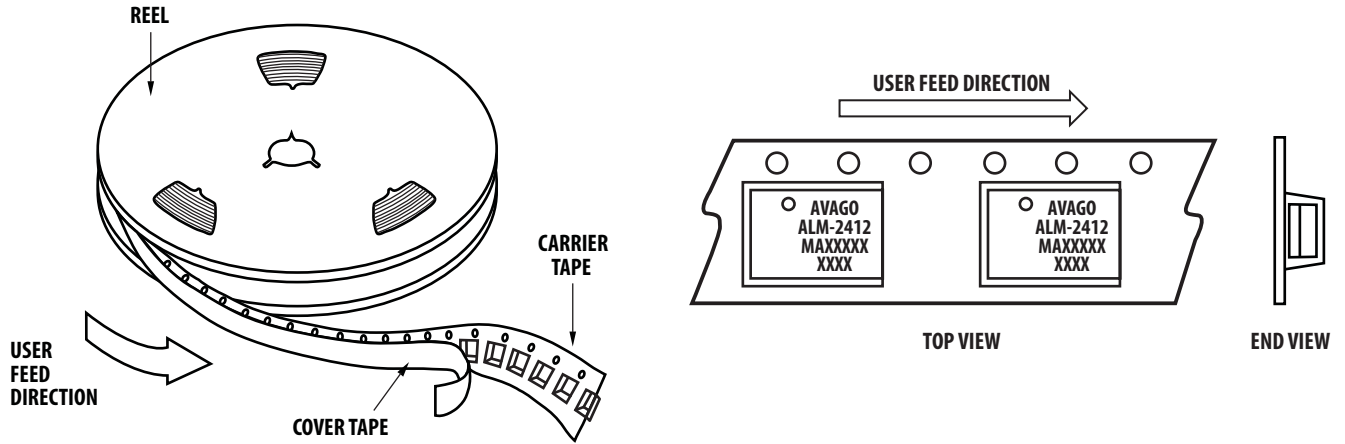

Tape Dimensions

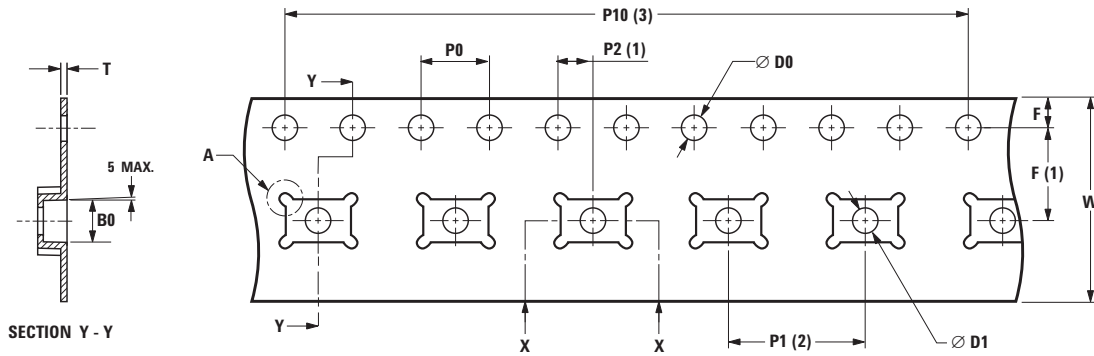

SECTION Y - Y

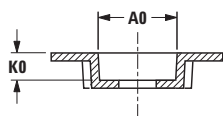

SECTION X - X

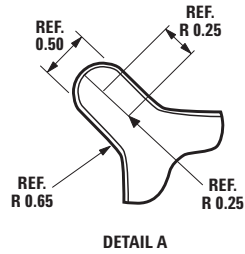

DETAIL A

NOTES:

1. MEASURE FROM CENTER LINE OF SPROCKET HOLE TO CENTER LINE OF POCKET.
2. MEASURE FROM CENTER LINE OF POCKET HOLE TO CENTER LINE OF POCKET.
3. PITCH TOLERANCE FOR SPROCKET HOLE: 10 PITCH CUMULATIVE TOLERANCE IS ± 0.2 mm.
4. ALLOWABLE CAMBER TO BE 1 mm PER 250 mm IN LENGTH.

DIMENSIONS

NOTATION	MILLIMETERS
A0	3.60 ± 0.10
B0	2.40 ± 0.10
K0	1.35 ± 0.10
D0	1.55 ± 0.05
D1	1.60 ± 0.10
P0	4.00 ± 0.10
P1	8.00 ± 0.10
P2	2.00 ± 0.10
P10	40.00 ± 0.20
E	1.75 ± 0.10
F	5.50 ± 0.10
W	12.00 ± 0.30
T	0.30 ± 0.05

Reel Dimensions – 13 inch

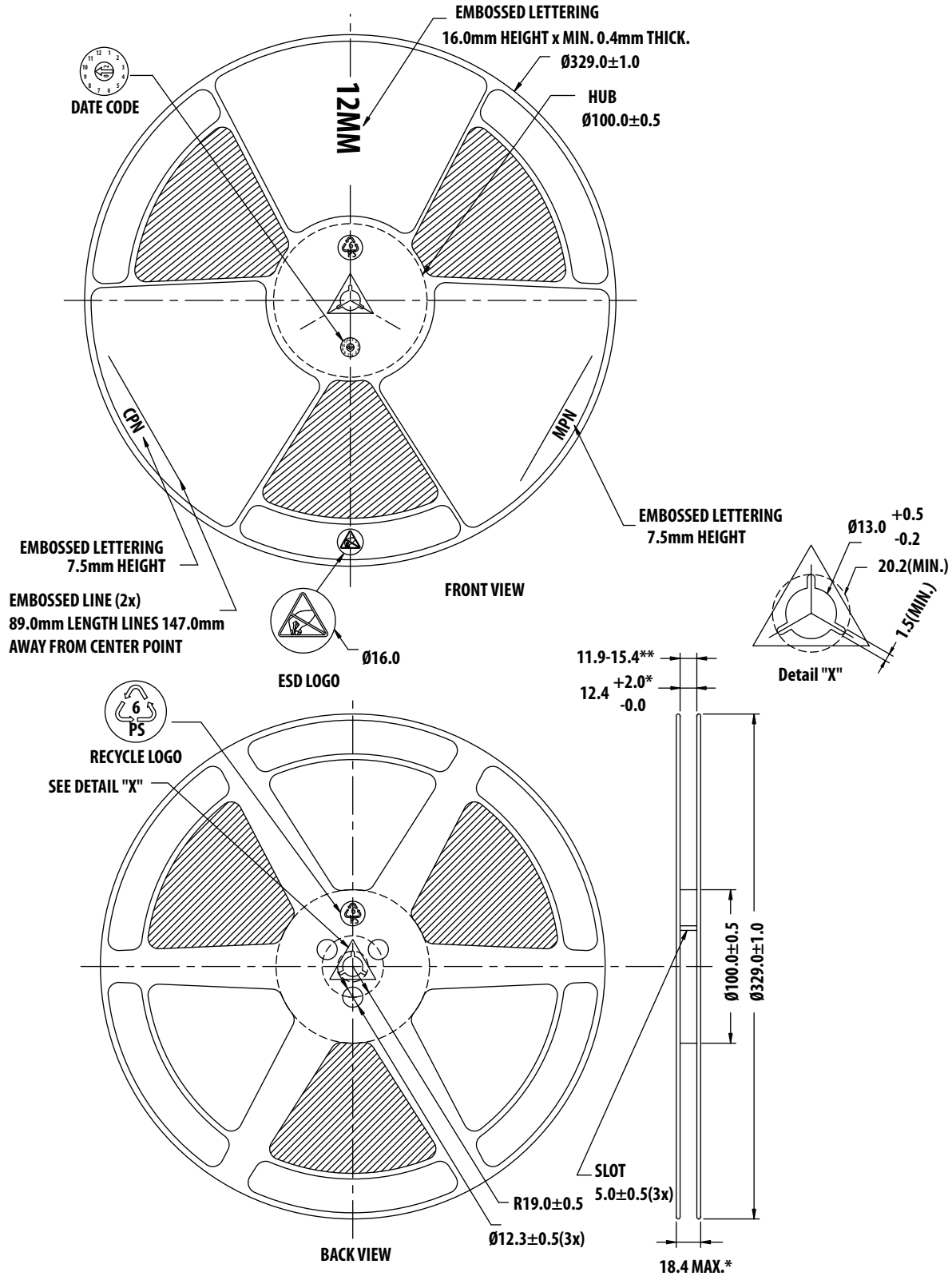

For product information and a complete list of distributors, please go to our web site: www.avagotech.com

Avago, Avago Technologies, and the A logo are trademarks of Avago Technologies in the United States and other countries. Data subject to change. Copyright © 2005-2012 Avago Technologies. All rights reserved. AV02-1757EN - March 2, 2012



Mouser Electronics

Authorized Distributor

Click to View Pricing, Inventory, Delivery & Lifecycle Information:

[Avago Technologies:](#)

[ALM-2412-TR1G](#) [ALM-2412-BLKG](#)