

WIZ220IO / WIZ220IO-EVB User's Manual (Ver. 1.1)

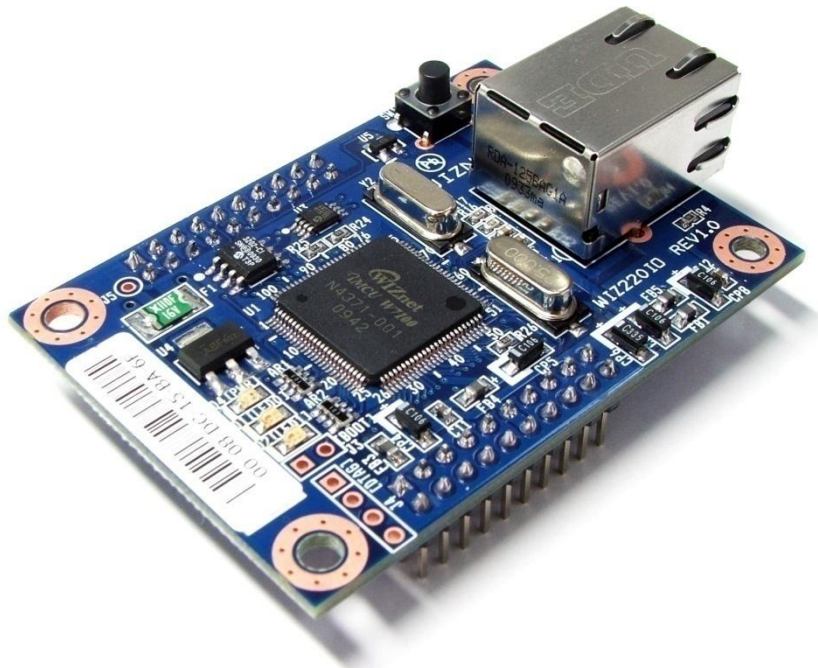

©2010 WIZnet Co., Ltd. All Rights Reserved.

For more information, visit our website at www.wiznet.co.kr

Document History Information

Revision	Data	Description
Ver. 1.0	2010. 04.	Release with WIZ220IO launching
Ver. 1.1	2010. 06.	<ul style="list-style-type: none">- Added description of notification option as updating firmware.<ul style="list-style-type: none">: The firmware ver.1.1 supports output control through the notification port. (The firmware ver.1.0 supports only transmission I/O status.)- modified description of configuration tool.<ul style="list-style-type: none">: The transmitting period unit of notification option is changed from '1sec' to '10ms' as updating firmware.: [Update I/O States] button in 'Input/Output' tab supports auto-clicking with time period.

Table of Contents

1. Introduction	6
1.1. <i>Main Function.....</i>	<i>6</i>
1.2. <i>Specification.....</i>	<i>7</i>
1.3. <i>Block Diagram.....</i>	<i>8</i>
2. WIZ220IO Base Board	9
3. Configuration Tool.....	12
3.1. <i>Basic description.....</i>	<i>12</i>
3.2. <i>Network Tab.....</i>	<i>13</i>
3.3. <i>Serial Tab.....</i>	<i>15</i>
3.4. <i>Input / Output Tab.....</i>	<i>16</i>
3.5. <i>Firmware Upload.....</i>	<i>16</i>
3.6. <i>Webpage Upload.....</i>	<i>17</i>
4. Notification Data Protocol	19
4.1. <i>Sending Protocol.....</i>	<i>19</i>
4.2. <i>Receiving Protocol.....</i>	<i>20</i>
5. WIZ220IO Specification	22
5.1. <i>Electrical Characteristics.....</i>	<i>22</i>
5.2. <i>Pin Header</i>	<i>22</i>
5.3. <i>RJ-45 connector</i>	<i>22</i>
5.4. <i>Board Dimensions and Pin Assignment.....</i>	<i>23</i>
6. Warranty	24

Tables

Table 1. WIZ220IO Specification	7
Table 2. WIZ220IO Base Board Specification	7
Table 3. Frame format of notification sending parameters.	19
Table 4. Sending parameter description in the notification function.	19
Table 5. Frame format of notification receiving parameters.....	20
Table 6. Receiving parameter description in the notification function.	20
Table 7. Electrical characteristics	22
Table 8. RJ-45 Pin Assignment.....	22
Table 9. WIZ220IO Dimension	23

Figures

Figure 1. Block Diagram	8
Figure 2. WIZ220IO Base Board Layout	9
Figure 3. WIZ220IO Module Interface	9
Figure 4. LED circuit of WIZ220IO Base Board	10
Figure 5. DI Switch of the WIZ220IO Base Board	10
Figure 6. Power adapter polarity	10
Figure 7. Variable Resistor Circuit of the WIZ220IO Base Board	11
Figure 8. Configuration Tool	12
Figure 9. Network Tab of the Configuration Tool	14
Figure 10. Serial Tab of the Configuration Tool	15
Figure 11. Input / Output Tab of the Configuration Tool	16
Figure 12. Firmware uploading window	17
Figure 13. Complete firmware uploading window	17
Figure 14. RJ-45 PIN Assignment	22
Figure 15. WIZ220IO Module Dimension	23

1. Introduction

WIZ220IO is an embedded remote I/O module which is able to control and monitor I/O port remotely via Internet. It is possible to monitor and control I/O port by using Windows application program or the embedded Web server. There are 16 digital I/O ports and 4 analog I/O supported by WIZ220IO. Additionally, the firmware and embedded webpage can also be updated remotely through the Ethernet.

WIZ220IO-EVB is the evaluation base board for users to evaluate WIZ220IO module quickly. There are 8 switches used for digital input test and 8 LEDs for digital output test, and a variable register for analog input test included in this evaluation board.

1.1. Main Function

- Operates as HTTP Server
- using W7100, all-in-one embedded network MCU with hardwired TCP/IP stack
- Provides Configuration Tool Program for easy control, monitoring and configuration
- Supports 10/100Mbps Ethernet
- 8 Digital Input Ports
- 8 Digital Output ports
- 2 Analog Input Ports with 12-bit resolution (Voltage Type)
- 2 Analog Output Ports with 12-bit resolution (Voltage Type)
- 1 UART Output Port
- Data acquisition and transmitting to specified host
- RoHS Compliant

1.2. Specification

Architecture	MCU	Standard 8051 compatible in W7100
	PHY	Included in W7100
	TCP/IP Stack	Hardwired TCP/IP Stack in W7100
Network	Network Protocols	ARP, ICMP, TCP/IP, UDP, HTTP Server, DHCP
	Network Interface	RJ-45, Auto-MDIX, Auto-Negotiation
Digital	Input	CMOS Digital Input
	Output	CMOS Digital Output
	UART	1 UART output Baud rate : 1200bps ~ 230400bps Data bit : 7bit, 8bit Parity : none, odd, even Stop bit : 1bit Flow control : none, RTS/CTS
Analog	Input	12bit resolution. Input Range(0 ~ Vcc)
	Output	12bit resolution. Output Range(0 ~ 4v)
Power	Input Voltage	DC 5V
	Power Consumption	Under 280mA @ 5V
Environment	Temperature	0°C ~ 70°C (Operation), -40°C ~ 85°C (Storage)
	Humidity	10 ~ 90%

Table 1. WIZ220IO Specification

Power	Socket	Inner pin Ø2.0, DC Power Jack
	Voltage	DC 5V
Digital Ports	Input	8-Switch
	Output	8-LED (Green chip-LED)
	UART	D-SUB 9PIN MALE
Analog	Input	2-Variable Resistor(10K ohm)
	Output	None(Through Hole)
I/O	Switch	Factory Reset Switch

Table 2. WIZ220IO Base Board Specification

1.3. Block Diagram

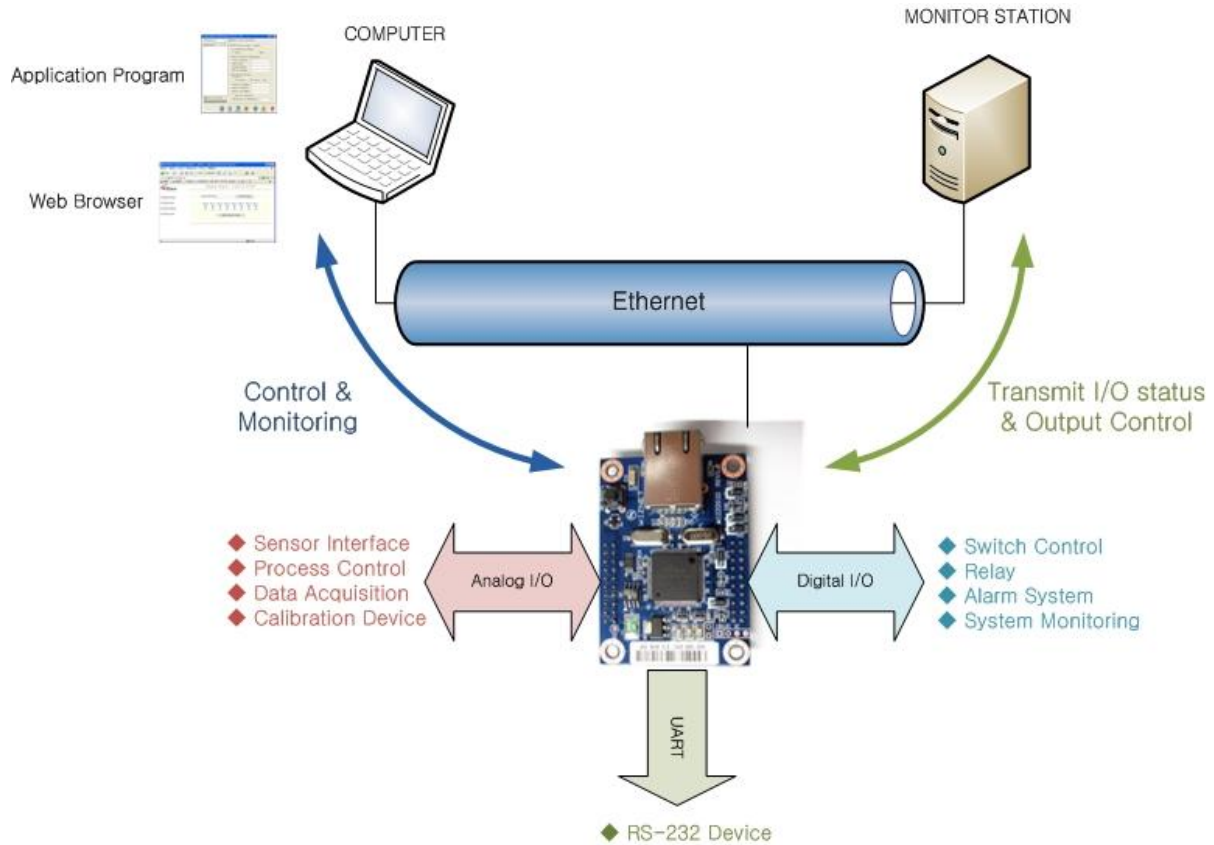

Figure 1. Block Diagram

WIZ220IO includes not only I/O controlling & monitoring but also I/O value transmission functions. The users can control or monitor via web browser in remote host PC, and configure the module's environment parameters and check the IO status via Configuration Tool program provided by WIZnet. The interface of WIZ220IO consists of analog interface and digital interface. 12 bits resolution analog I/O, 3.3V digital output and the maximum 5.5V digital input are supported by WIZ220IO. The digital I/Os are internally pulled up. The users can use Web browser or Configuration Tool to remotely control the interfaces. Also, user can control output port by transmitting control data through the notification port.

2. WIZ220IO Base Board

WIZ220IO module can be tested by using base board.

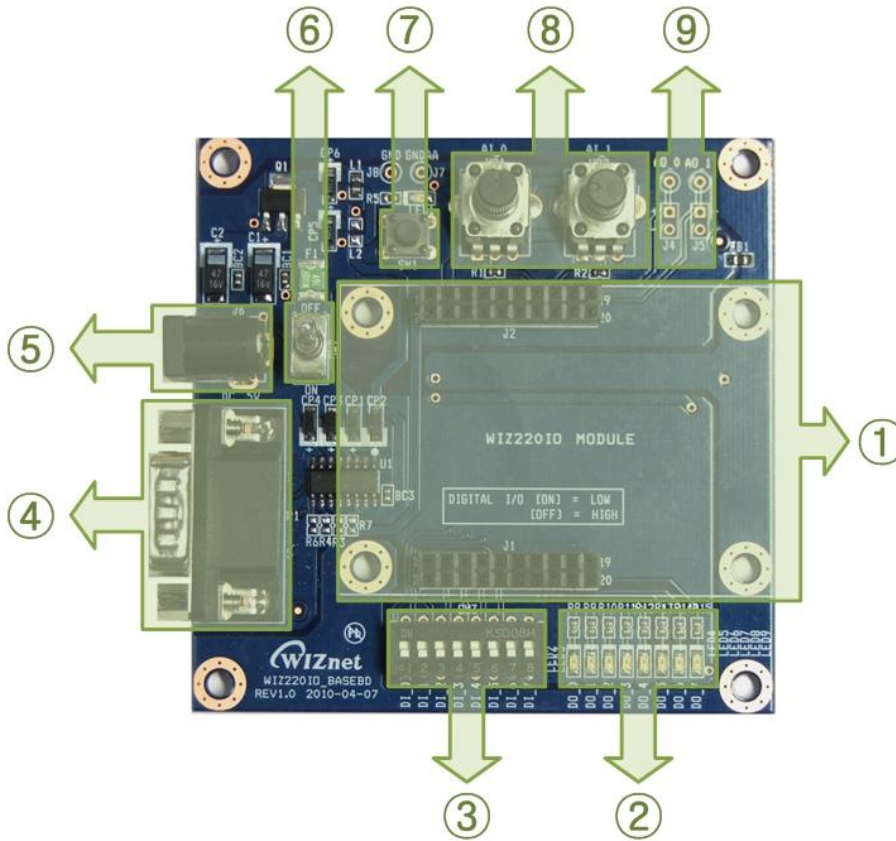

Figure 2. WIZ220IO Base Board Layout

① WIZ220IO Module Connector

It is an interface for WIZ220IO Module.

[Caution] Observe pin position and align when mounting the module on the base board. Incorrect mounting can damage the WIZ220IO module and base board, and your product warranty does not cover such damage.

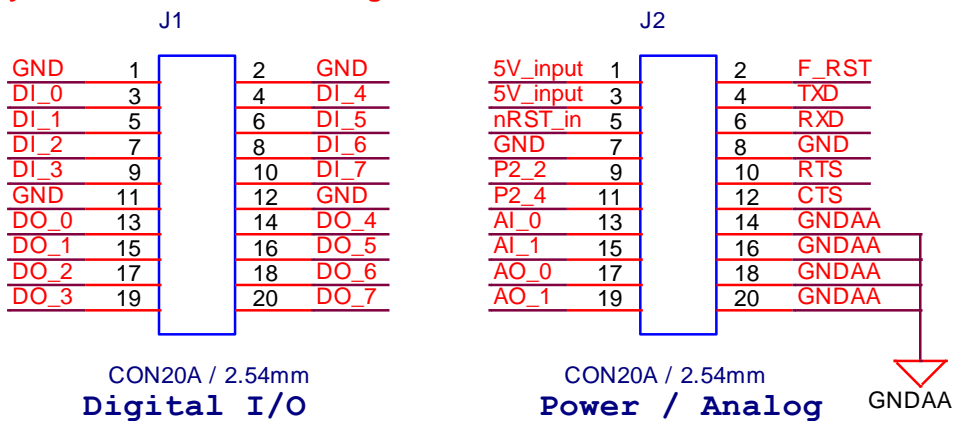

Figure 3. WIZ220IO Module Interface

② LED

8 LEDs are indicating each Digital Output ports. When the port signal is LOW, the LED light is turned on.

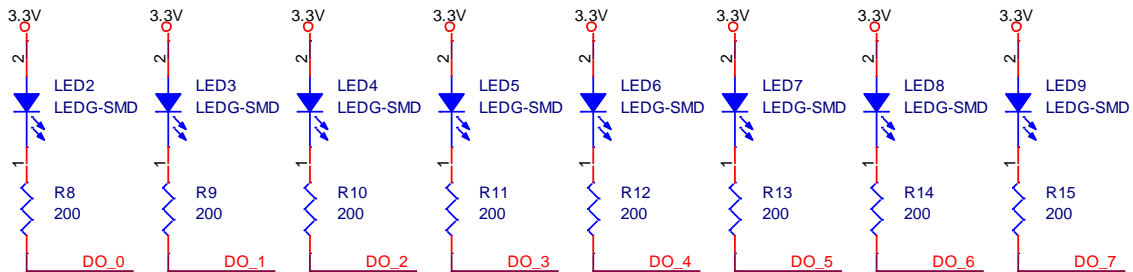

Figure 4. LED circuit of WIZ220IO Base Board

③ Switch

8 switches are controlling each Digital Input ports. When you turn switch on, the digital port signal will be LOW.

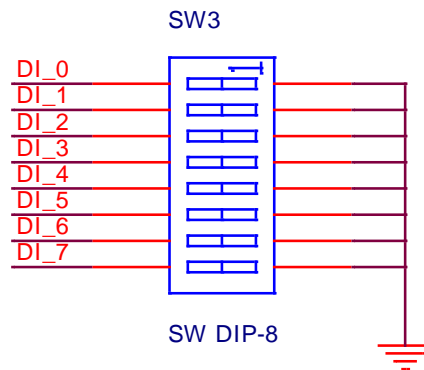

Figure 5. DI Switch of the WIZ220IO Base Board

④ D-SUB9

This connector is for an UART. The WIZ220IO's UART port can be used for debug message or data output through the webpage. It supports RTS/CTS flow control.

⑤ Power

The power can be controlled by using power switch after connecting the DC 5V (min 500mA) adapter.

[Caution] Observe polarity and voltage when connecting the power adapter. Incorrect input polarity or voltage can damage the WIZ220IO module and base board, and your product warranty does not cover such damage.



Figure 6. Power adapter polarity

- ⑥ Power Switch
It controls power of WIZ220IO module and base board.

- ⑦ Factory Reset button
Factory reset button can recover configuration parameter to factory default values. To reset the module's parameters to factory default, hold down the factory reset button when you turn power switch on.

- ⑧ Variable Resistor (VR)
You can control analog input value with variable resistor. The WIZ220IO's analog input is voltage type and its range is 0V to Vcc(5V). Also, its value was translated to 0~4095 as each input port has 12-bit resolution.

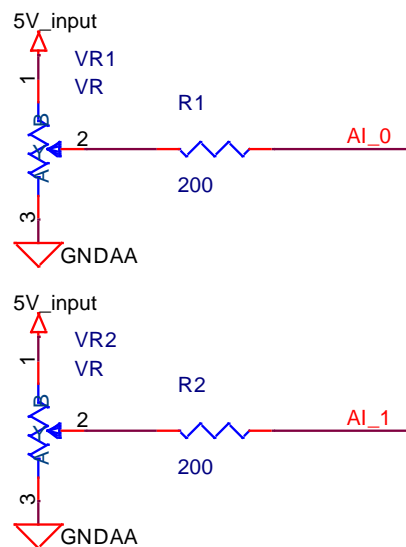

Figure 7. Variable Resistor Circuit of the WIZ220IO Base Board

- ⑨ Analog Output Through Hole
It can be connected to external device by user application. Each port outputs its value as voltage level, and the range of output voltage is '0~4V'. The maximum output value is 4095 that generates 4V level. The hole pitch is 2.54mm.

3. Configuration Tool

The configuration tool supports below major functions. All functions of configuration tool can be performed remote area through the Ethernet.

- Change module's configuration.
- I/O monitoring and controlling
- Firmware uploading
- Webpage uploading

3.1. Basic description

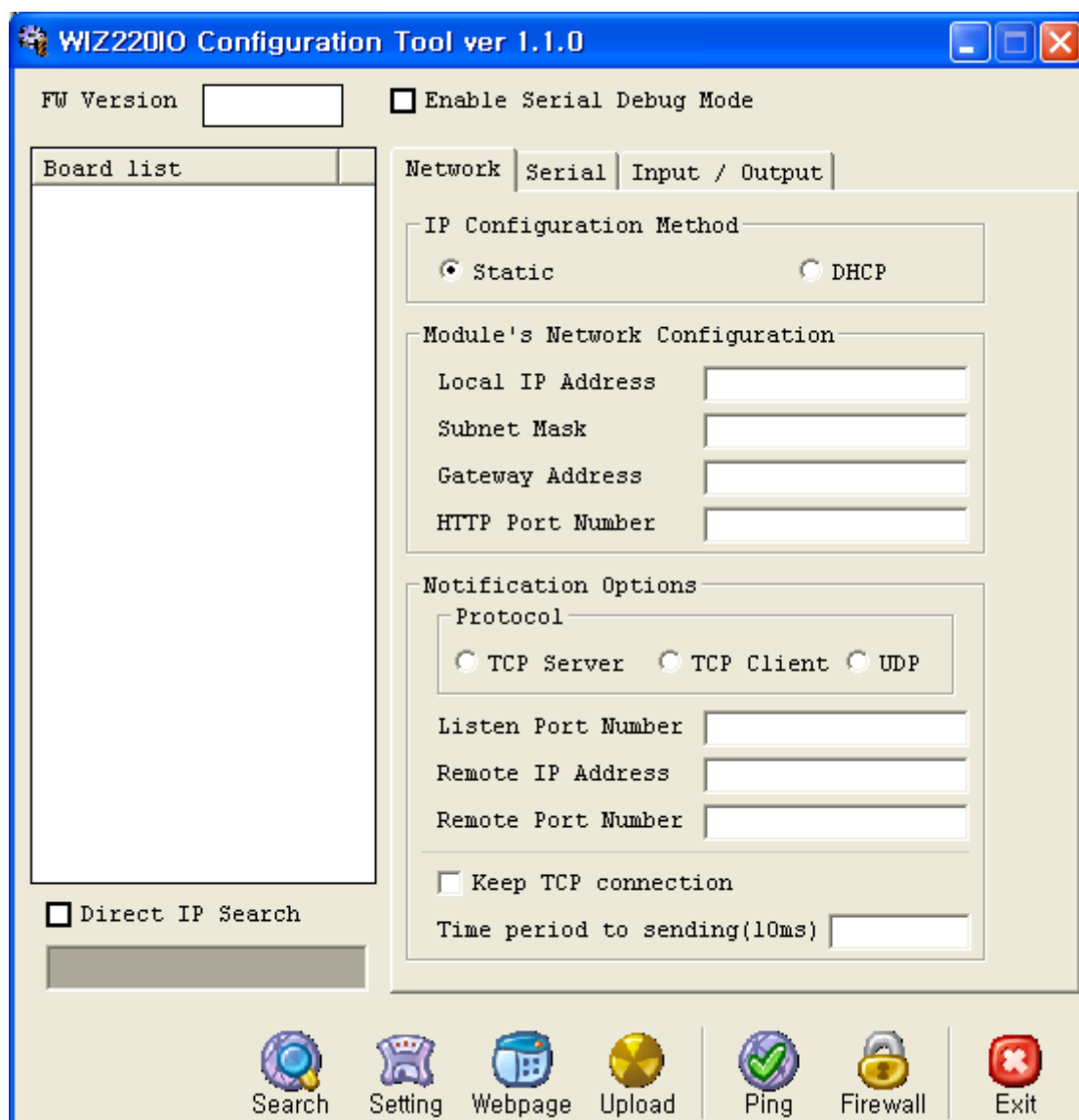

Figure 8. Configuration Tool

- **FW Version:** It displays firmware version.

- **Enable Serial Debug Mode:** If this mode is checked, you can monitor the status and socket message (listen OK, connect fail etc.) through serial terminal.
- **Board List:** If you click the “SEARCH” button, all the MAC address on a same subnet will be displayed. When you check the “Direct IP Search” and enter the specified IP address, the board list will display its MAC address.
- **Direct IP Search:** Direct IP Search can be used for searching WIZ220IO which is not installed in the same subnet. If the Direct IP Search is checked, the configuration tool use the TCP instead of UDP broadcast to search the module. Therefore, network information of the module such as IP address, subnet mask and gateway address is required for the search.
[Warning] If module does not have valid network information, Direct IP Search is not available. If the module is connected to the NAT or private network, it is not possible to connect to the module from outside.
- **Search:** The Search function is used to search all modules existing on the same LAN. By using UDP broadcast, all modules on the same subnet will be searched. The searched module is displayed as MAC address in the “Board List”.
- **Setting:** This function is to complete the configuration change. If you select the MAC address from the “Board List”, the current configuration values of the module will be displayed. Change the configuration value and click “Setting” button to complete the configuration. After that, the module will re-initialize with the changed configuration.
- **Webpage:** It is possible to upload ROM Image file to the internal flash memory of WIZ220IO. For more information, refer to “3.6. Webpage Upload”.
- **Upload:** It is possible to upload new firmware file through the Ethernet. For more information, refer to “3.5. Firmware Download”.
- **Ping:** It is used to test whether the WIZ220IO module is reachable across a network from your PC with ICMP protocol. After inputting host IP address in new pop-up window, click the “PING” button. Then, it will be displayed its result.
- **Firewall:** It controls your PC’s firewall configuration. If board list does not display even though clicking search button, check your PC’s firewall.
- **Exit:** Close the configuration tool program.

3.2. Network Tab

In the Network Tab of the configuration tool, network information and the notification parameters can be set. The network information is for a communication through the Ethernet such as an IP address, a gateway address and a subnet mask. If the module cannot be assigned with the fixed information from ISP provider, you can set the DHCP option. By setting DHCP option, the network information can

be assigned by DHCP server.

The notification option is a function for sending the I/O values to the specified host every specified period. It is useful for acquiring data log.

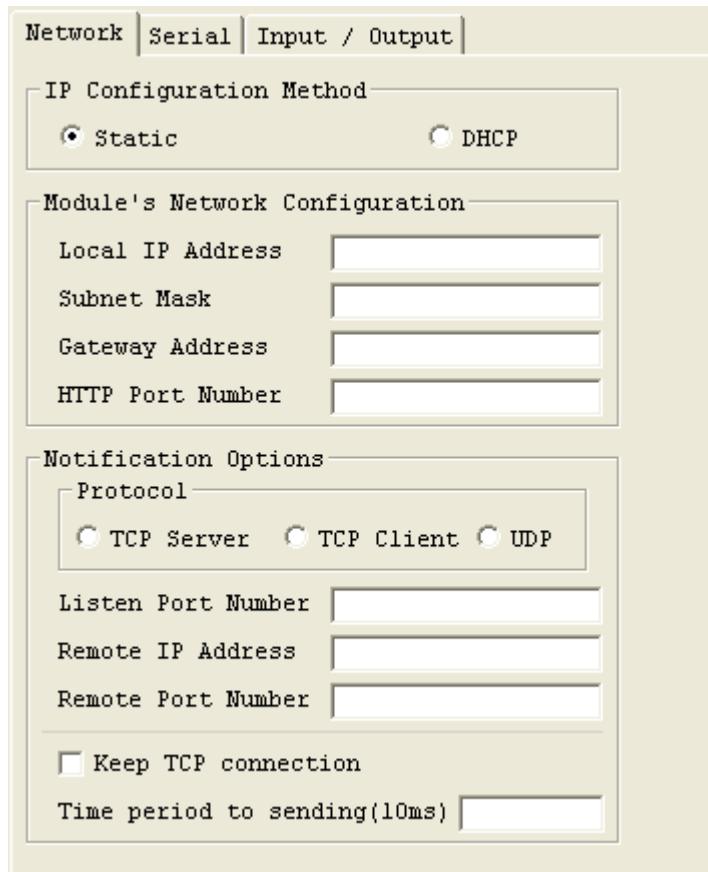

Figure 9. Network Tab of the Configuration Tool

- **IP Configuration Method:** You can select STATIC or DHCP. The STATIC option can be selected when your network resource can give the fixed IP address, and the DHCP option can be selected when your network has DHCP server such as a router who has DHCP server function.
- **Local IP Address:** IP address of the WIZ220IO module.
- **Subnet Mask:** Subnet mask of the WIZ220IO module.
- **Gateway address:** Gateway address of the WIZ220IO module.
[Warning] Be sure to input correct network information. If you input incorrect information, it can cause network collision or mal-function.
- **HTTP Port Number:** You can change webserver's listen port number. The HTTP default port number is 80.

- **Notification Options – Protocol:** The WIZ220IO can send I/O values to the specified host. The notification protocol can be set as TCP server or TCP client or UDP mode. The “TCP Server” waits for the connection trial from the host, The “TCP Client” tries to connect to the host’s IP address and port number. At the “UDP” mode, the connection establishment is not defined. After setting the IP address and port number of the host, just send data.
- **Notification Options – Listen Port Number:** It is valid only on “TCP Server” mode. The WIZ220IO module will accept connection with listen port number.
- **Notification Options – Remote IP Address / Remote Port Number:** It is valid on “TCP Client” and “UDP” modes. Input the host IP address and port number.
- **Notification Options – Keep TCP connection:** If you check this option, the WIZ220IO module maintains the connection as sending keep-alive packet. If you uncheck this option, the module closes the connection after sending data.
- **Notification Options – Time period to sending:** It is possible to set the sending period. To disable notification option, input ‘0’ to this parameter.
[Caution] In the firmware version1.0, this parameter’s unit is the 1-second. From the firmware version1.1, the unit is the 10ms.

3.3. Serial Tab

Serial tab is for the UART configuration. The UART is used to display debug message and to output the UART data through the webpage.

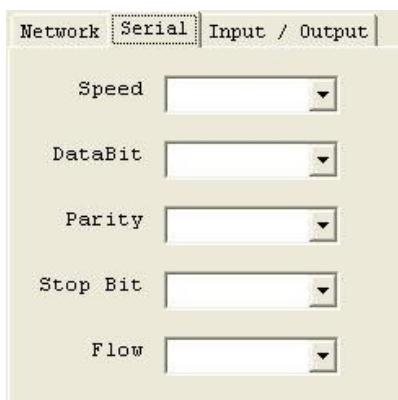

The screenshot shows a web-based configuration interface with three tabs: 'Network', 'Serial', and 'Input / Output'. The 'Serial' tab is active. Below the tabs, there are five configuration options, each with a dropdown menu:

- Speed
- DataBit
- Parity
- Stop Bit
- Flow

Figure 10. Serial Tab of the Configuration Tool

- Speed: It supports baud rate from 1200bps to 230400bps.
- Data Bit: It supports 7bit or 8bit of data bit.
- Parity: It supports odd, even and none option of parity.
- Stop Bit: It supports only 1bit.
- Flow: It supports flow control – none, RTS/CTS.

3.4. Input / Output Tab

Input/Output tab is for the I/O control and monitoring. When you click the “Update I/O Status” button, it will be displayed I/O parameters at that time.

In the Digital parameters, a green indicator means port is asserted ‘HIGH’ and a gray indicator means ‘LOW’. Each port can be set ‘HIGH’ as checking checkbox in ‘Digital Output Control’ and click the ‘Update I/O Status’ button.

The Analog I/O has range from 0 to 4095 and it has voltage type. In the Analog input status, ‘4095’ means maximum input value that is same to ‘5V_Input’ (Vcc) value. However, analog output maximum value ‘4095’ generates 4V. In other word, the analog output maximum value is 4V.

[Warning] At the digital input, if you set the switch on the base board, module recognizes it as “low”. At the digital output, when the module is “low”, LED on the base board becomes on.

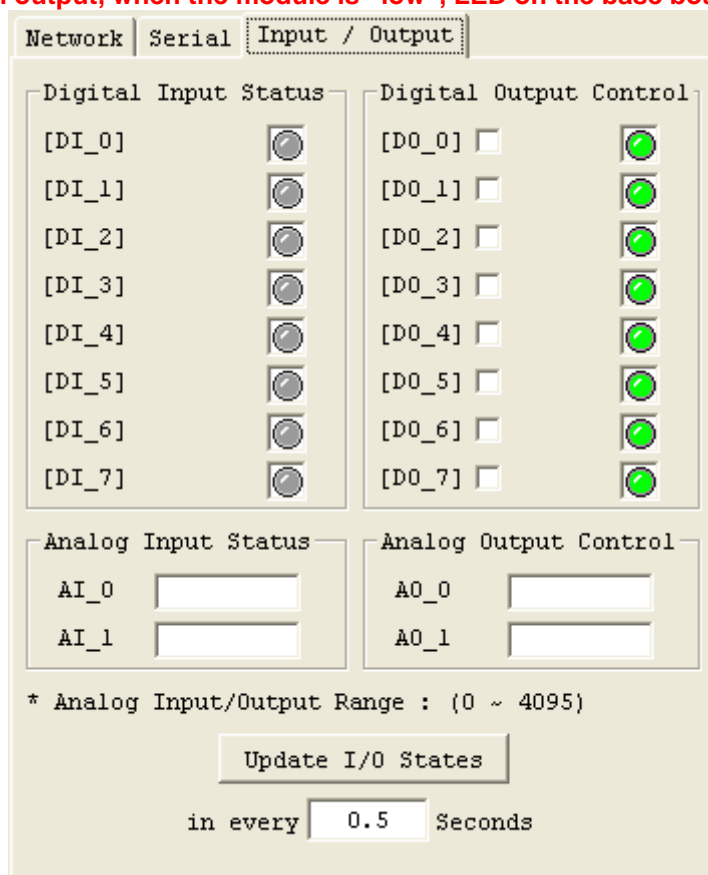

Figure 11. Input / Output Tab of the Configuration Tool

3.5. Firmware Upload

- ① Execute WIZ220IO configuration tool and click ‘Search’ button.
- ② If the module is correctly connected to the network, its MAC address is displayed on the ‘Board list’.
- ③ Select the board at the ‘Board list’ and click ‘Upload’ button.

[Warning] Before uploading through Ethernet, the network information should be set for correct network communication. The configuration tool send ping request automatically, and if there is no reply from board, it will display error message.

④ When the dialog box is shown, select the Binary file and click 'OPEN' button.

[Warning] Be sure to use firmware only for the WIZ220IO.

⑤ You can see below status window showing 'Processing'.

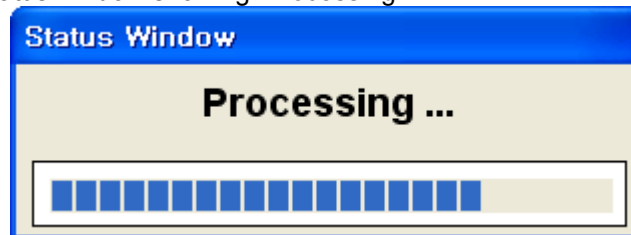

Figure 12. Firmware uploading window

⑥ If the file is uploaded, 'Complete firmware uploading' message will be displayed.

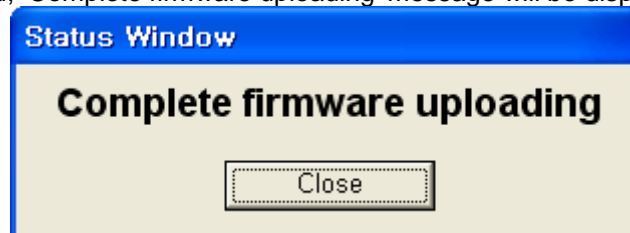

Figure 13. Complete firmware uploading window

3.6. Webpage Upload

① Execute WIZ220IO configuration tool and click 'Search' button.

② If the module is correctly connected to the network, its MAC address is displayed on the 'Board list'.

③ Select the board at the 'Board list' and click 'web page Upload' button.

[Warning] Before uploading through Ethernet, the network information should be set for correct network communication. The configuration tool send ping request automatically, and if there is no reply from board, it will display error message.

④ When the dialog box is shown, select the Flash Rom File System (*.rom) file and click 'OPEN' button.

[Warning] The Flash Rom File system should be created by using "Rom File Maker Tool rev3.0". For the detail, refer to "3.6.1. Use of Rom File Maker rev3.0".

⑤ If the file is uploaded, 'Complete webpage uploading' message will be displayed.

3.7. Rom File Maker rev3.0

Rom File Maker rev3.0 is the tool for creating ROM Image which enables the webpage to be stored in the Flash memory.

① Select the webpage by using 'Add Files' button.

[Warning] There is limitation of file number in selecting at a time. (Normally, max 15 files can be selected simultaneously). If there are more files, use "Add Files" button for the several times.

② Select 'Rom Image File' option. If you click 'Make Image' button, '*.rom' file can be created.

[Warning] The limitation of the ROM image size is 20476bytes. If the file size is over 20476bytes, it does not guarantee the normal operation.

4. Notification Data Protocol

WIZ220IO uses the pre-defined notification protocol to transfer the I/O status to the specified server, and control the output port by using received commands. Both TCP and UDP are supported in this function. In the TCP mode, socket should be established for exchanging data.

4.1. Sending Protocol

The length of I/O status data to be transferred is 45 bytes in total. The data format is defined as follows.

	0	1	2	3	4	5	6	7	8	9	A	B	C	D	E	F	
0x00	ID					SEQ				MAC address							
0x10	IP address				DI[0]	DI[1]	DI[2]	DI[3]	DI[4]	DI[5]	DI[6]	DI[7]	DO[0]	DO[1]	DO[2]	DO[3]	
0x20	DO[4]	DO[5]	DO[6]	DO[7]	AI_0	AI_1	AO_0	AO_1	End char								

Table 3. Frame format of notification sending parameters.

Field	Size(byte)	value	Description
ID	6	WIZ220	module's ID. Fixed value as 'WIZ220'.(Hex: 57 49 5A 32 32 30)
SEQ	4	variable	Sequence number of data transmission. This value set to 0 when connection is closed in TCP mode.
MAC	6	Fixed	module's MAC address
IP	4	Fixed	module's IP address.
DI[n]	8	'H' or 'L'	digital input value. It can be set to 'H'(0x48) or 'L'(0x4C) as input port status.
DO[n]	8	'H' or 'L'	digital output value. It can be set to 'H'(0x48) or 'L'(0x4C) as output port status.
AI_0	2	variable	analog input #0. The range of value is 0x0000~0x0FFF.
AI_1	2	variable	analog input #1. The range of value is 0x0000~0x0FFF.
AO_0	2	variable	analog output #0. The range of value is 0x0000~0x0FFF.
AO_1	2	variable	analog output #1. The range of value is 0x0000~0x0FFF.
End char	1	0xFF	end char of notification sending parameter

Table 4. Sending parameter description in the notification function.

- Total data size : 45 bytes
- [ID], [MAC], [IP], and [End char] fields are fixed.
- The transmitted digital value in Firmware v1.0 is different from above Table 4. The value will be 0x00 when the port in low voltage level, as well the value 0x01 indicates the port is in high voltage level.

4.2. Receiving Protocol

Data transmission and the output port can be controlled via notification port. Please note this function is only available in Firmware v1.1 or later.

	0	1	2	3	4	5	6	7	8	9	A	B	C	D	E	F	
0x00	ID						OP[0]	OP[1]	OP[2]	OP[3]	IP				DO[0]	DO[1]	
0x10	DO[2]	DO[3]	DO[4]	DO[5]	DO[6]	DO[7]	AO_0		AO_1								
0x20	UART																
0x30												End char					

Table 5. Frame format of notification receiving parameters.

Field	Size(byte)	value	Description
ID	6	WIZ220	module's ID. Fixed value as 'WIZ220'.(Hex: 57 49 5A 32 32 30)
OP	4	'O' or not	Output control select flag. 'O'(0x4F) means user would like to control specified port. if OP field is not 'O', the module does not change specified port. OP[0] : Digital Output OP[1] : Analog Output #0 OP[2] : Analog Output #1 OP[3] : UART Output
IP	4	Fixed	module's IP address
DO[n]	8	'H' or 'L'	digital output value. It can be set to 'H'(0x48) or 'L'(0x4C). If this value is not 'H' or 'L', port output is not changed.
AO_0	2	0x0000 ~ 0x0FFF	analog output #0. The range of value is 0x0000~0x0FFF. If you input this over 0x0FFF, it will be set 0x0FFF.
AO_1	2	0x0000 ~ 0x0FFF	analog output #1. The range of value is 0x0000~0x0FFF. If you input this over 0x0FFF, it will be set 0x0FFF.
UART	32	variable	UART value can be inputted max. 32 bytes. If data is null(0x00), the module stop output UART data.
End char	1	0x00	end char of notification receiving parameter

Table 6. Receiving parameter description in the notification function.

- Total data size : 59 bytes
- User should send whole control data at a time.
- The module does not control output port as below conditions:
 - mismatch ID value
 - OP[n] value is not 'O'(0x4F).

- mismatch IP value : You should input module's IP address as hex value.
- mismatch [End char] value
- If you send data to module over 59 bytes, excess data will be ignored.

5. WIZ220IO Specification

5.1. Electrical Characteristics

Parameters	Min	Typ	Max	Units
Input Voltage (Vcc)	4.5	5	5.5	V
High Level Digital Input	2.0	-	5.5	V
Low Level Digital Input	-0.5	-	0.8	V
High Level Digital Output	3.3	-	-	V
Low Level Digital Output	-	-	0.4	V
Digital Output Current			8	mA
Analog Input Range	Vss	-	Vcc	V
Analog Input Leakage Current		.001	±1	µA
Analog Output Range	0	-	4	V
Analog Output Short Circuit Current		15	24	mA
Operation Temperature	0	-	70	°C
Storage Temperature	-40	-	85	°C
Power Consumption(@DC5V)			280	mA

Table 7. Electrical characteristics

5.2. Pin Header

- 2x10Pin Dual Line, 2.54mm Pitch, 12mm height
- Lead length = 6mm
- Straight Type
- Gold Plating
- Current Rating:1A
- Insulation Resistance:500Mohm
- Dielectric Withstanding Voltage:500VAC

5.3. RJ-45 connector

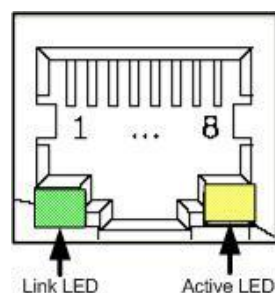

Figure 14. RJ-45 PIN Assignment

Pin	Signal
1	TX+
2	TX-
3	RX+
6	RX-

Table 8. RJ-45 Pin Assignment

5.4. Board Dimensions and Pin Assignment

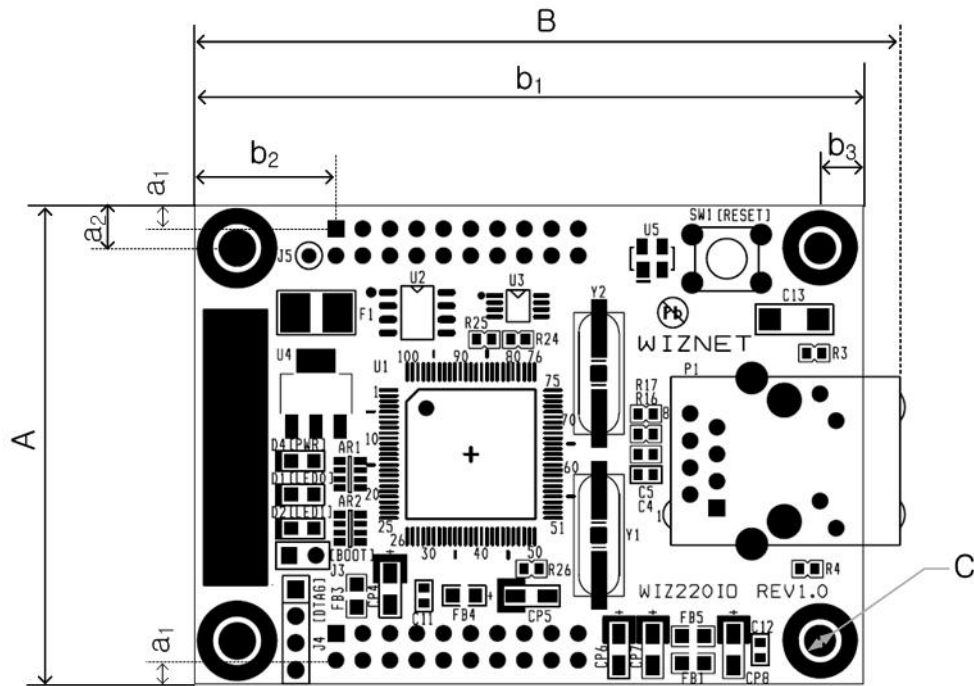

Figure 15. WIZ220IO Module Dimension

Symbol	mm
A	45.00
a ₁	2.18
a ₂	4.00
B	66.50
b ₁	63.00
b ₂	13.34
b ₃	4.00
C	3.00

Table 9. WIZ220IO Dimension

6. Warranty

WIZnet Co., Ltd. offers the following limited warranties applicable only to the original purchaser. This offer is non-transferable.

WIZnet warrants our products and its parts against defects in materials and workmanship under normal use for period of standard ONE(1) YEAR for the WIZ220IO module and labor warranty after the date of original retail purchase. During this period, WIZnet will repair or replace a defective products or part free of charge.

Warranty Conditions:

The warranty applies only to products distributed by WIZnet or our official distributors.

1. The warranty applies only to defects in material or workmanship as mentioned above in 7. Warranty.
2. The warranty applies only to defects which occur during normal use and does not extend to damage to products or parts which results from alternation, repair, modification, faulty installation or service by anyone other than someone authorized by WIZnet ; damage to products or parts caused by accident, abuse, or misuse, poor maintenance, mishandling, misapplication, or used in violation of instructions furnished by us ; damage occurring in shipment or any damage caused by an act of God, such as lightening or line surge.

Procedure for Obtaining Warranty Service

1. Contact an authorized distributors or dealer of WIZnet for obtaining an RMA (Return Merchandise Authorization) request form within the applicable warranty period.
2. Send the products to the distributors or dealers together with the completed RMA request form. All products returned for warranty must be carefully repackaged in the original packing materials.
3. Any service issue, please contact to sales@wiznet.co.kr

Mouser Electronics

Authorized Distributor

Click to View Pricing, Inventory, Delivery & Lifecycle Information:

[WIZnet:](#)

[WIZ220IO-EVB](#)