

Ni1000SOT

Temperature Sensor

SPECIFICATIONS

- **Contact temperature sensing**
- **Comply with former DIN 43760 standard**
- **Small SMD package SOT 23**
- **Automotive qualified**

Ni1000SOT is a nickel thin film resistance temperature detector (RTD) that is suitable for use in contact temperature sensing.

The devices are manufactured by PVD-deposition on a silicon substrate. The thin film structure is covered by a passivation layer for environmental protection and enhanced stability. The nickel elements are mounted on lead frames and encapsulated in SOT23 packages. This technology allows the production of miniature, low cost, high precision temperature sensors.

The characteristics of the temperature sensor comply with the former DIN 43760 standard. It is qualified for the most demanding automotive applications (incl. exposure to hot oil) and is suitable for many more applications in harsh environments

FEATURES

- Resistance: 1000 ohms at 0°C
- Min/ Max temp -55°C to +160°C
- Good linearity between resistance and temperature (R V's T)
- Large temperature coefficient of resistance: 6178 ppm/K (0°C, 100°C)
- Low power consumption
- Good thermal contact via Pin 3
- Tape and reel (8mm format)

APPLICATIONS

- Temperature sensing, control and compensation
- General instrumentation
- Automotive (VW standard 801-01 vibration)
- Remote sensing

PERFORMANCE SPECS

Parameter	Symbol	Condition	Min.	Typ.	Max.	Unit
Basic resistance	R ₀	0°C	997,81	1000	1002,20	Ω
Temperature coefficient of resistance (according to DIN 43760, see below)	TCR	0°C to +100°C	6100	6178	6240	ppm/K
Measurement current	I			0.2	5	mA
Self heating coefficient	EK	+23 °C, still air	1.4	1.7	2	mW/K
Operation temperature	T _{Op}		-55		+160	°C
Maximum resistance drift	ΔR	1000h@150°C		0.1		%
Storage temperature	T _{St}		-55		+160	°C
ESD resistant		MIL 883E3015.7		Class 1		

SELF HEATING EFFECT

For accurate temperature measurement it is recommended to choose a small current to avoid self heating of the nickel sensing element. The temperature error caused by excessive measurement current can be calculated using: $\Delta T = P/EK$

where $P = I^2 \cdot R$ is the power generated by the measurement current and EK is the self heating coefficient.

PACKAGE INFORMATION

Parameter	Condition	Typ.	Unit
Package		SOT23	
Soldering	Reflow to + 260°C	96Sn4Ag	
Packing units		13" (330 mm) / 10000	Reel Size / # of sensors
Package marking		Three Digit code: "1" + "XX", where "XX" is the revision.	

TYPICAL PERFORMANCE CURVES

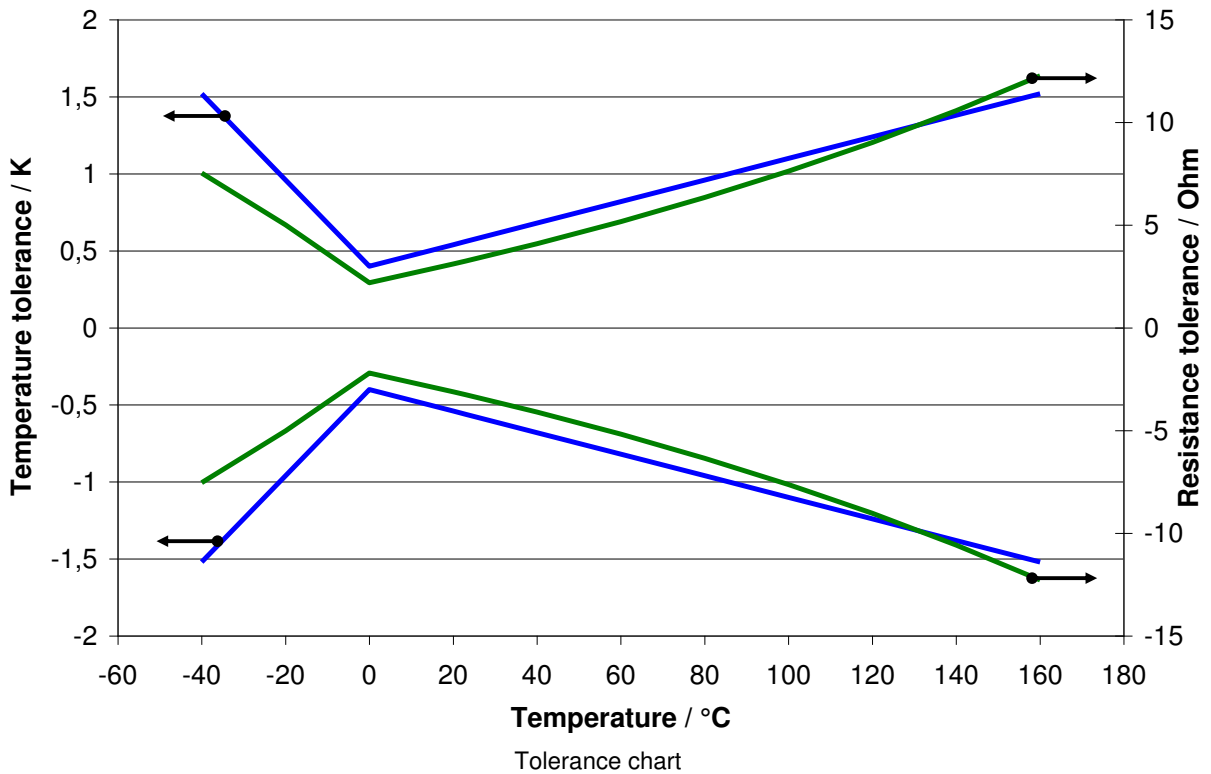
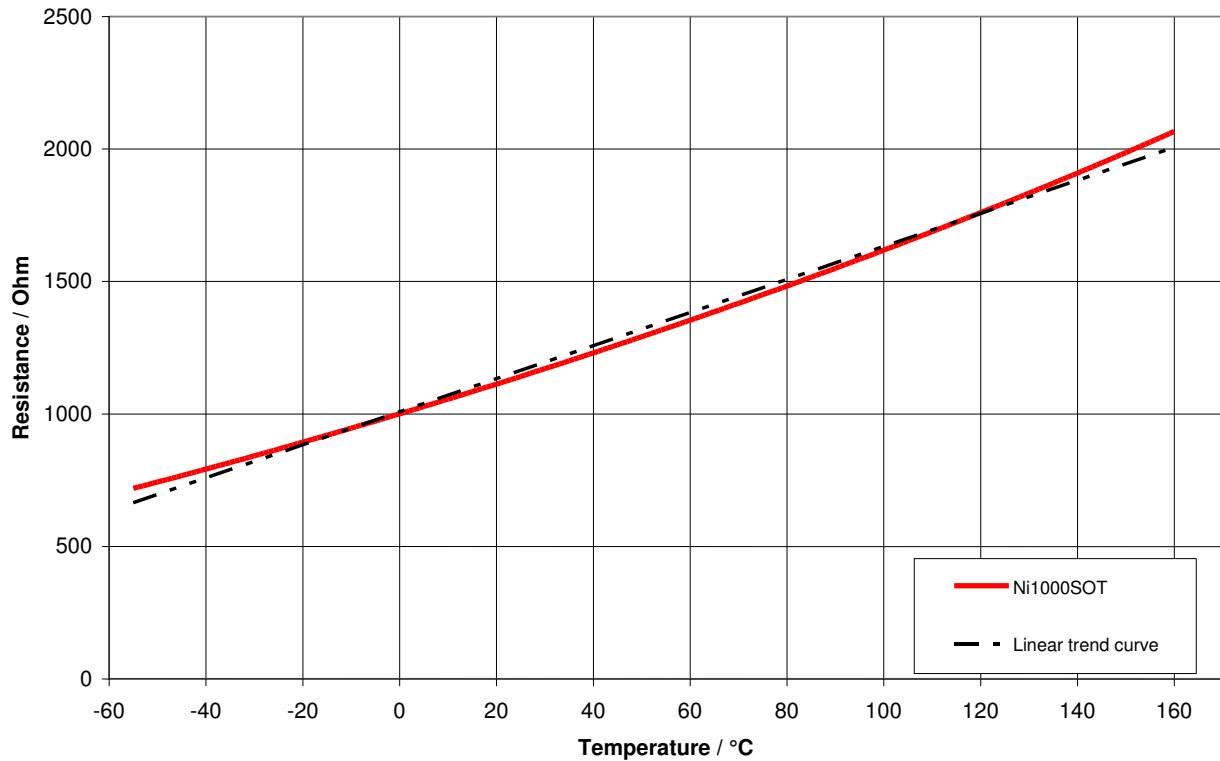

MECHANICAL DIMENSIONS

PACKAGE DIMENSIONS SOT23

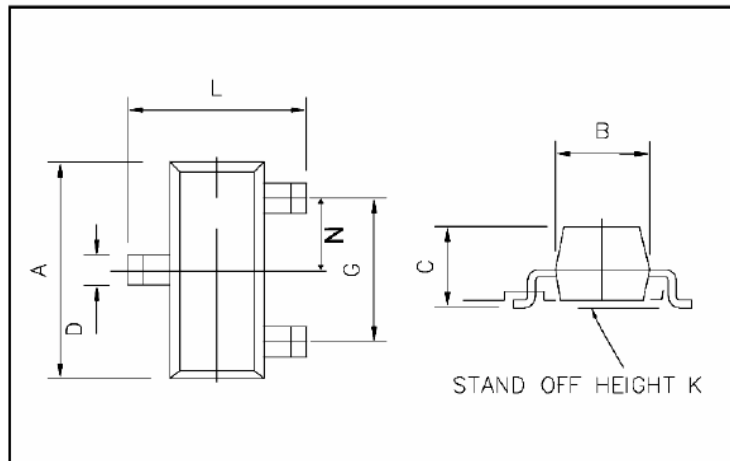

DIM	Millimeters		Inches	
	Min	Max	Min	Max
A	2.67	3.05	0.1051	0.1201
B	1.20	1.40	0.0472	0.0551
C	0.89	1.12	0.0350	0.0441
D	0.37	0.53	0.0146	0.0209
G	1.78	2.05	0.0701	0.0807
K	0.01	0.10	0.0004	0.0039
L	2.10	2.64	0.0827	0.1039
N	0.89	1.03	0.0350	0.0406

PIN DIMENSIONS

Dimension	Millimeters		Inches	
	Min	Max	Min	Max
Pin Thickness	0.085	0.18	0.0033	0.0071

CONNECTIONS

<p>Top view:</p>	Pin # 1	Nickel RTD electrical contact
	Pin # 2	Nickel RTD electrical contact
	Pin # 3	Electrically isolated thermal contact

APPLICATION NOTE 1

Analogue Interface Circuit for general purpose measurement

The following voltage dividing circuit can be used for low accuracy measurements. There is no linearization given.

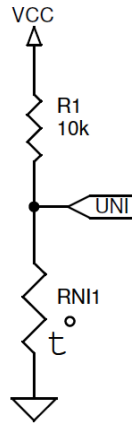

Example of voltage dividing circuit using Ni1000SOT sensor

The output voltage will be calculated by the following equation:

$$UNI = RNI1 / (R1 + RNI1) \cdot VCC$$

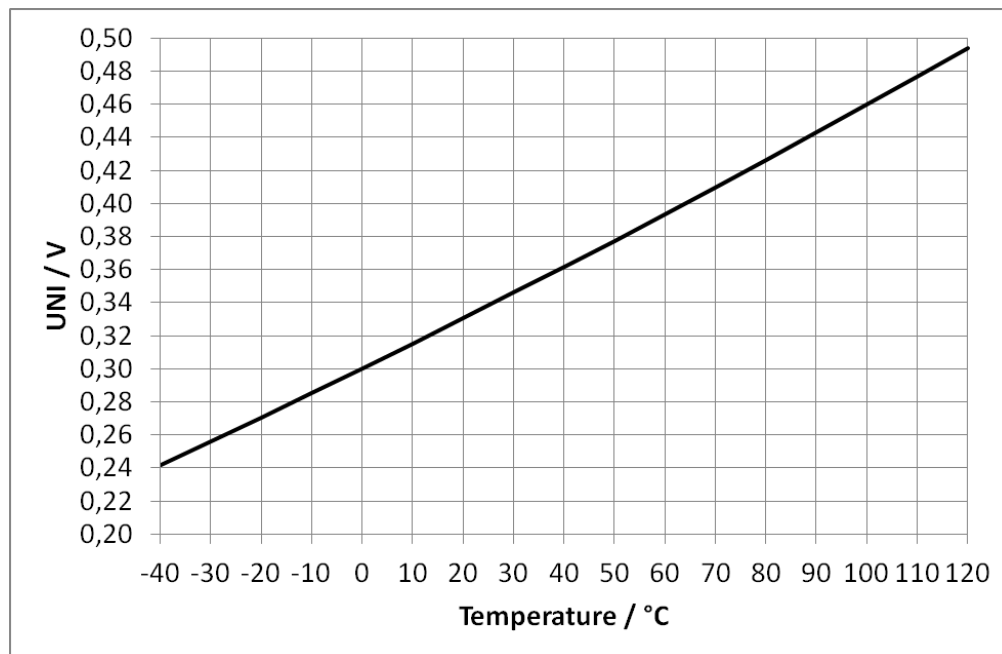

Output voltage characteristics with VCC = 3.3V

APPLICATION NOTE 2

Analogue Interface Circuit for high accuracy measurement

The following circuitry utilizes the output of a bridge circuitry which is amplified in order to improve the measurement resolution. By bridging RNI with an optional 3.65kOhm resistor this circuitry can be linearized.

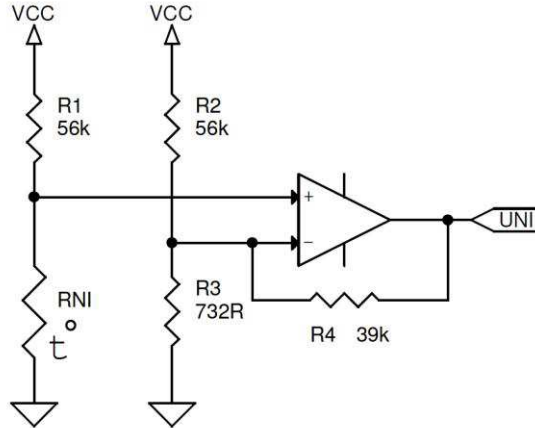

Example of analog interface circuit for high accuracy measurement using Ni1000SOT sensor

The output voltage will be calculated by the following equation:

$$UNI = \frac{RNI}{R1+RNI} \cdot VCC \cdot [1 + R4 \cdot (1/R2 + 1/R3)] - R4/R2 \cdot VCC$$

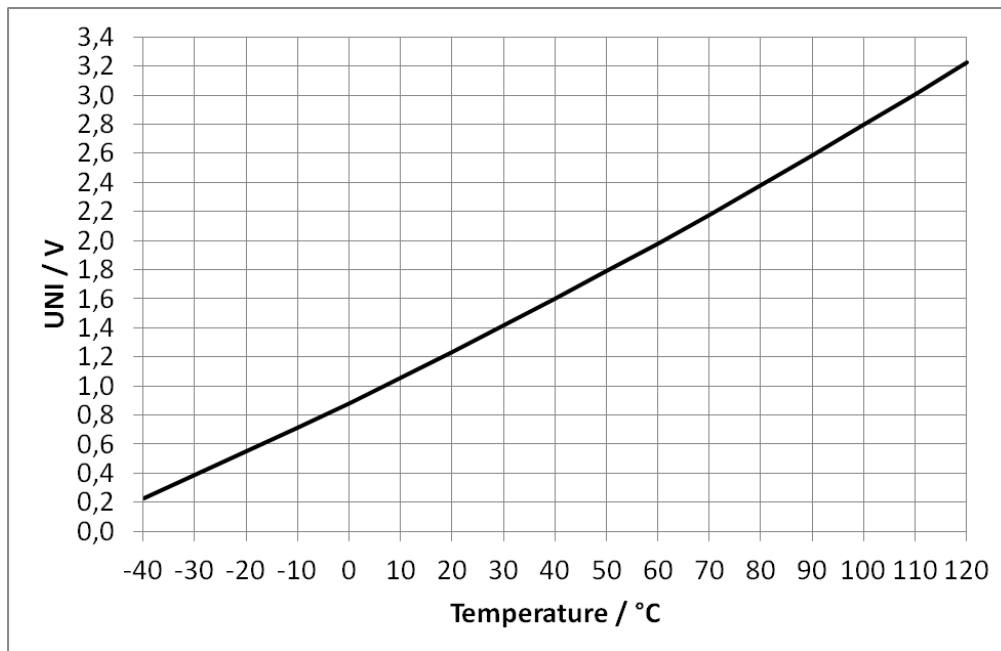

Output voltage characteristics with VCC = 3.3V

ORDER INFORMATION

Please order this product using following:	
Part Number	Part Description
G-NICO-001	Ni1000SOT

DEFINITIONS AND DISCLAIMERS

- Application information – Applications that are described herein for any of these products are for illustrative purpose only. MEAS Deutschland GmbH makes no representation or warranty that such applications will be suitable for the specified use without further testing or modification.
- Life support applications – These products are not designed for use in life support appliances, devices, or systems where malfunctions of these products can reasonably be expected to result in personal injury. MEAS Deutschland GmbH customers using or selling this product for use in such applications do so at their own risk and agree to fully indemnify MEAS Deutschland GmbH for any damages resulting from such improper use or sale.

NORTH AMERICA

Measurement Specialties, Inc.,
a TE Connectivity Company
910 Turnpike Road
Shrewsbury, MA 01545
United States
Phone: +1-508-842-0516
Fax: +1-508-842-0342
Email: temperature.sales.amer@meas-spec.com
Web: www.meas-spec.com

EUROPE

Measurement Specialties (Europe), Ltd.,
a TE Connectivity Company
Deutschland GmbH
Hauert 13
D-44227 Dortmund
Germany
Phone: +49-(0)231-9740-0
Fax: +49-(0)231-9740-20
Email: info.de@meas-spec.com
Web: www.meas-spec.com

ASIA

Measurement Specialties (China), Ltd.,
a TE Connectivity Company
No. 26 Langshan Road
Shenzhen High-Tech Park (North)
Nanshan District, Shenzhen 518057
China
Tel: +86 755 3330 5088
Fax: +86 755 3330 5099
Email: temperature.sales.asia@meas-spec.com
Web: www.meas-spec.com

TE.com/sensorsolutions

Measurement Specialties, Inc., a TE Connectivity company.

Measurement Specialties, TE Connectivity, TE Connectivity (logo) and EVERY CONNECTION COUNTS are trademarks. All other logos, products and/or company names referred to herein might be trademarks of their respective owners.

The information given herein, including drawings, illustrations and schematics which are intended for illustration purposes only, is believed to be reliable. However, TE Connectivity makes no warranties as to its accuracy or completeness and disclaims any liability in connection with its use. TE Connectivity's obligations shall only be as set forth in TE Connectivity's Standard Terms and Conditions of Sale for this product and in no case will TE Connectivity be liable for any incidental, indirect or consequential damages arising out of the sale, resale, use or misuse of the product. Users of TE Connectivity products should make their own evaluation to determine the suitability of each such product for the specific application.

© 2015 TE Connectivity Ltd. family of companies All Rights Reserved.

Mouser Electronics

Authorized Distributor

Click to View Pricing, Inventory, Delivery & Lifecycle Information:

[TE Connectivity:](#)

[G-NICO-001](#)