

# RFSA3715

## 5MHz to 4000MHz, Digital Step Attenuator

The RFMD's RFSA3715 is a 7-bit digital step attenuator (DSA) that features high linearity over the entire 31.75dB gain control range with 0.25dB steps. The RFSA3715 features three modes of control: serial addressable, latched parallel and direct parallel programming. The RFSA3715 has a low insertion loss of 1.5dB at 2GHz. Patent pending circuit architecture providing overshoot-free transient switching performance. External address pins allow up to eight DSAs to be controlled on a single bus. The RFSA3715 is available in a 5mm x 5mm QFN package.



Package: QFN, 32-pin,  
5.0mm x 5.0mm x 0.85mm

### Features

- 7-Bit, 31.75dB Range, 0.25dB Step
- Patent Pending Circuit Architecture
- Overshoot-free Transient Switching Performance
- Frequency Range 5MHz to 4000MHz
- High Linearity, IIP3 >55dBm
- Serial and Parallel Control Interface
- Fast Switching Speed, <120nsec
- Serial Addressable Supports Up to Eight Addresses
- Single Supply 3V to 5V Operation
- RF Pins Have No DC Voltage, Can Be DC Grounded Externally
- Power-up Default Setting is Maximum Attenuation

### Applications

- 2G through 4G Base Stations
- Point-to-Point
- WiMax/WiFi
- Test Equipment

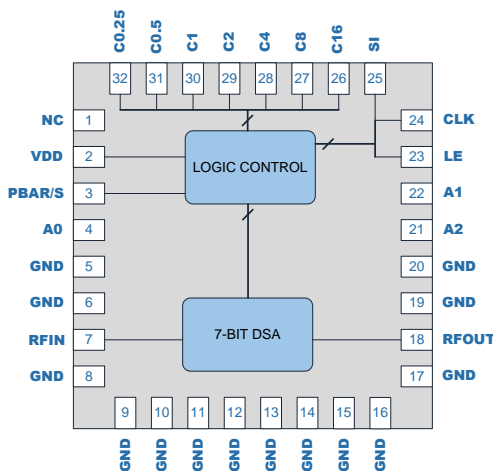

Functional Block Diagram

### Ordering Information

RFSA3715SQ	Sample bag with 25 pieces
RFSA3715SR	7" Reel with 100 pieces
RFSA3715TR13	13" Reel with 2500 pieces
RFSA3715PCK-410	5MHz to 4000MHz PCBA with 5-piece sample bag

## Absolute Maximum Ratings

Parameter	Rating	Unit
Supply Voltage ( $V_{DD}$ )	-0.5 to +6.0	V
All Other DC and Logic Pins	-0.5 to $V_{DD}$	V
Maximum Input Power at RFIN Pin at 85°C	+30	dBm
Maximum Input Power at RFOUT Pin at 85°C	+27	dBm
Storage Temperature Range	-40 to +150	°C
ESD Rating - Human Body Model (HBM)	1000	V
Moisture Sensitivity Level	MSL1	



**Caution!** ESD sensitive device.



RFMD Green: RoHS status based on EU Directive 2011/65/EU (at time of this document revision), halogen free per IEC 61249-2-21, < 1000ppm each of antimony trioxide in polymeric materials and red phosphorus as a flame retardant, and <2% antimony in solder.

Exceeding any one or a combination of the Absolute Maximum Rating conditions may cause permanent damage to the device. Extended application of Absolute Maximum Rating conditions to the device may reduce device reliability. Specified typical performance or functional operation of the device under Absolute Maximum Rating conditions is not implied.

## Recommended Operating Condition

Parameter	Specification			Unit
	Min	Typ	Max	
Operating Temperature Range (RF Input Power Handling Derates Above 85°C)	-40		+105	°C
Operating Junction Temperature			125	°C
Supply Voltage	2.7		5.5	V

## Nominal Operating Parameters

Parameter	Specification			Unit	Condition
	Min	Typ	Max		
<b>General Performance</b>					
Supply Current		180		μA	Steady state operation, current draw during attenuation state transitions is higher.
Thermal Resistance		55		°C/W	
RF Input Power at RFIN Pin			27	dBm	Continuous operation at +85°C case temperature
RF Input Power at RFOUT Pin			20	dBm	
<b>RF Performance</b>					
Frequency Range	5		4000	MHz	
Insertion Loss		1.5		dB	2000MHz, 0dB attenuation
Attenuation Range		31.75		dB	0.25dB step size
Absolute Attenuation Error	±(0.2 + 4%)			dB	
Input IP3		55		dBm	
Input P0.1dB		30		dBm	
Return Loss		15		dB	
Input and Output Impedance		50		Ω	

Parameter	Specification			Unit	Condition
	Min	Typ	Max		
<b>General Performance</b>					
Switching Speed		120		nsec	50% control to 10%/90% RF
Successive Step Phase Delta		2		Deg	2000MHz
<b>Control</b>					
Digital Logic Low			0.63	V	
Digital Logic High	1.17			V	

Note: Typical performance at these conditions: +25°C, 2000MHz, 5V supply voltage

Typical Application Schematic

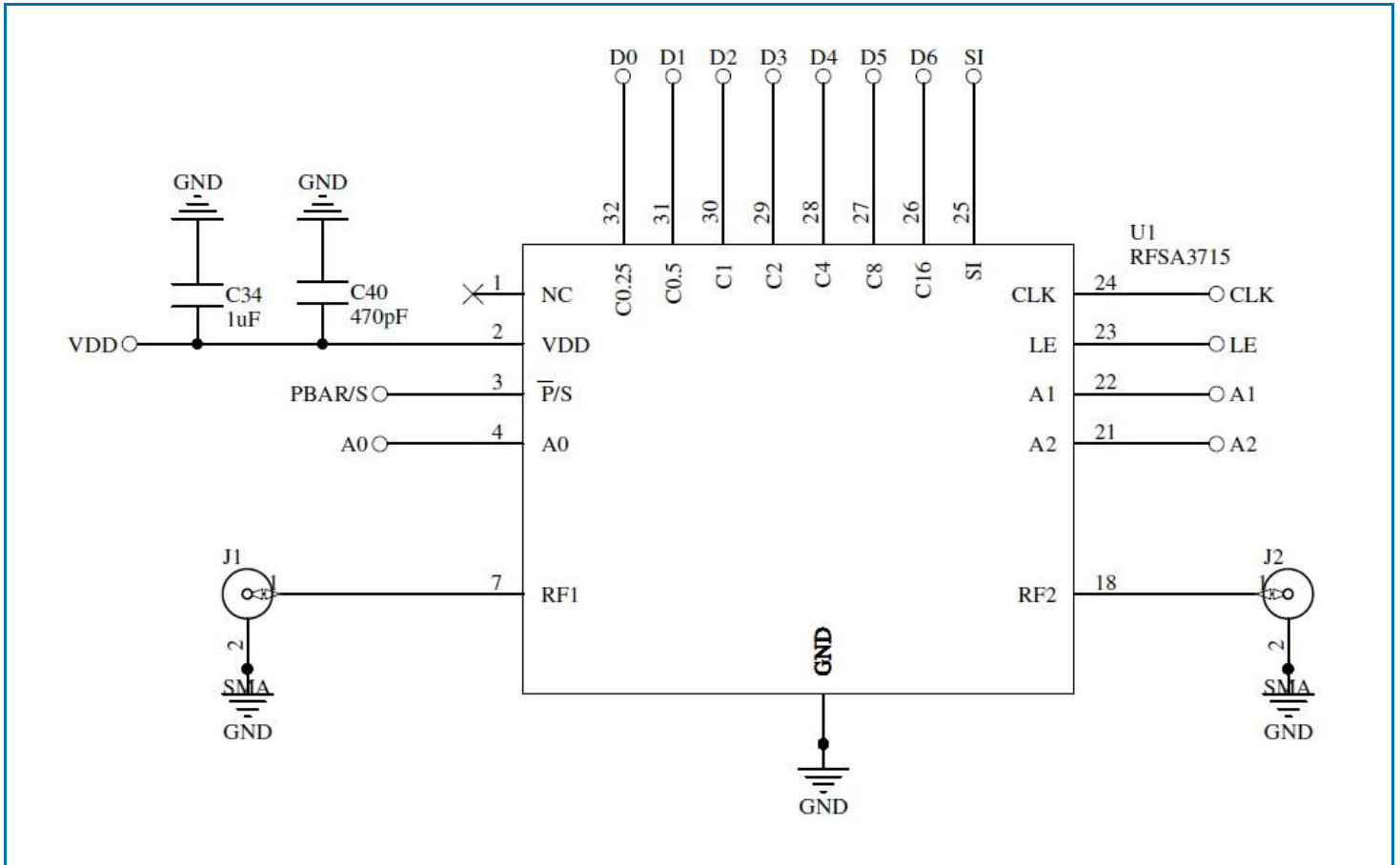

Typical Performance:

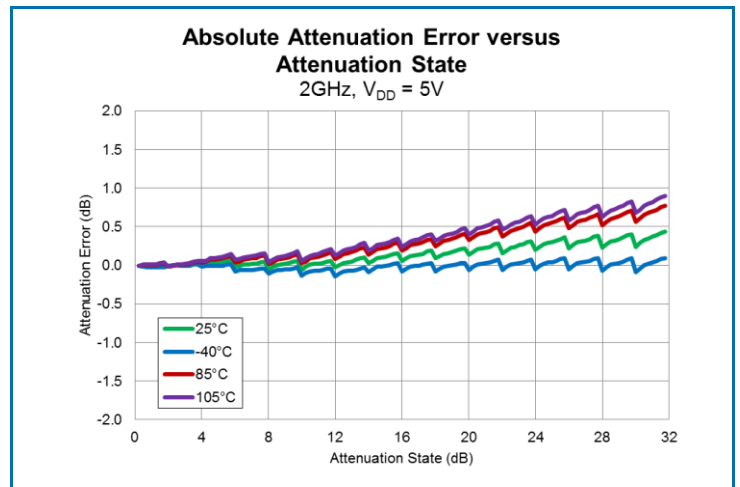
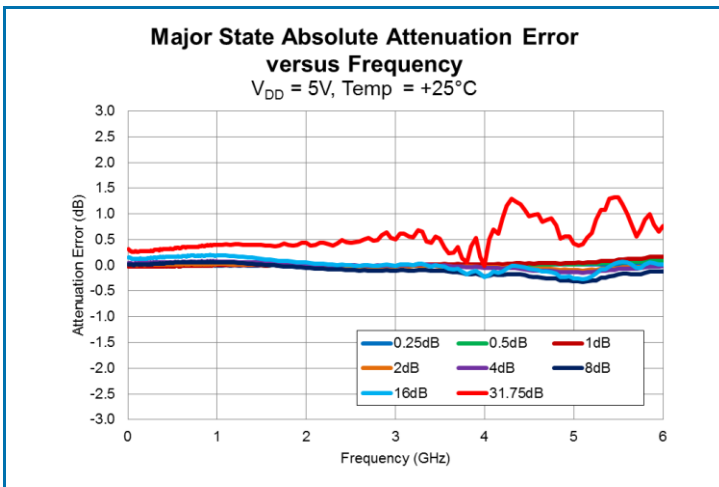
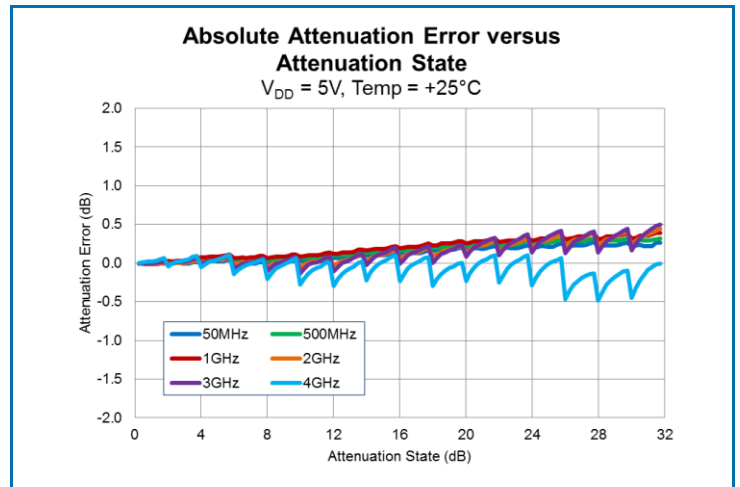
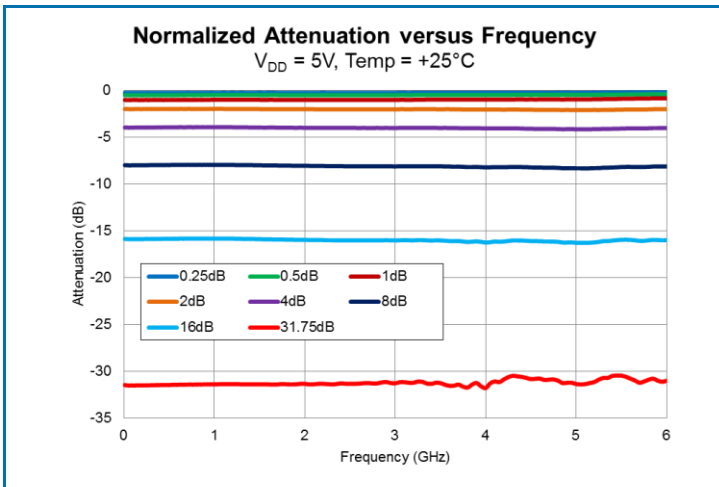
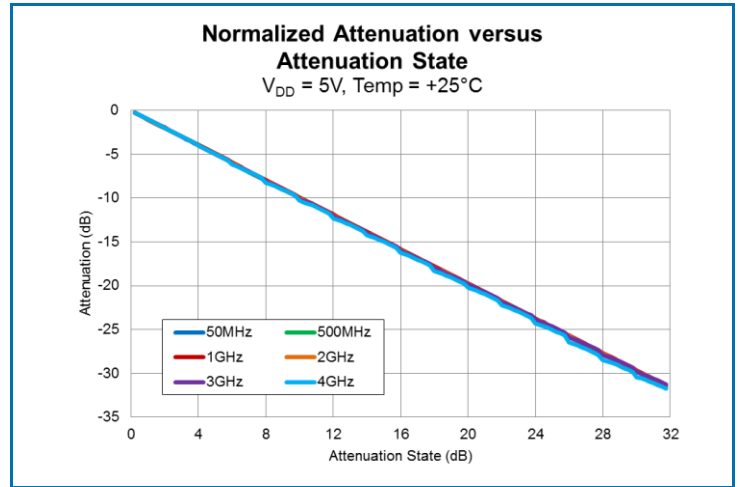
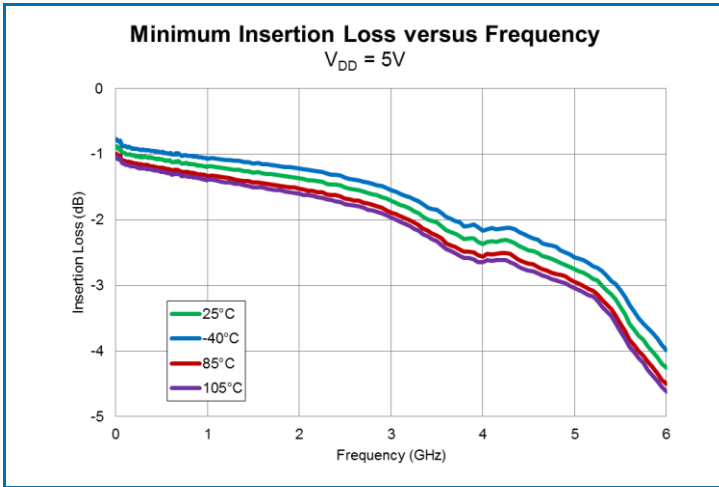

Typical Performance:

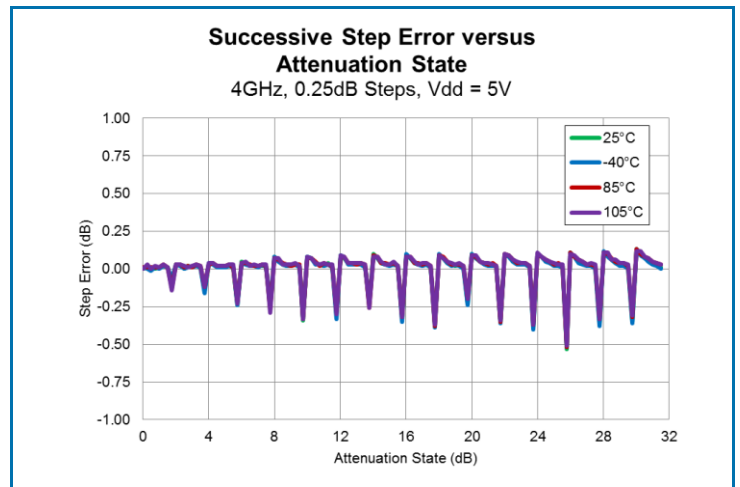
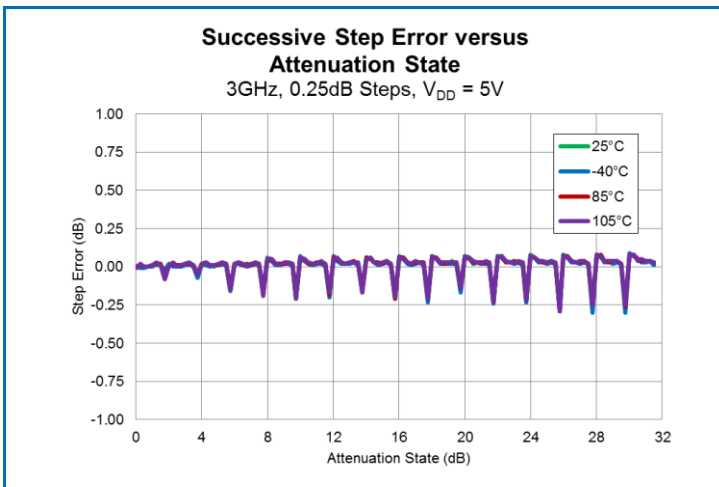
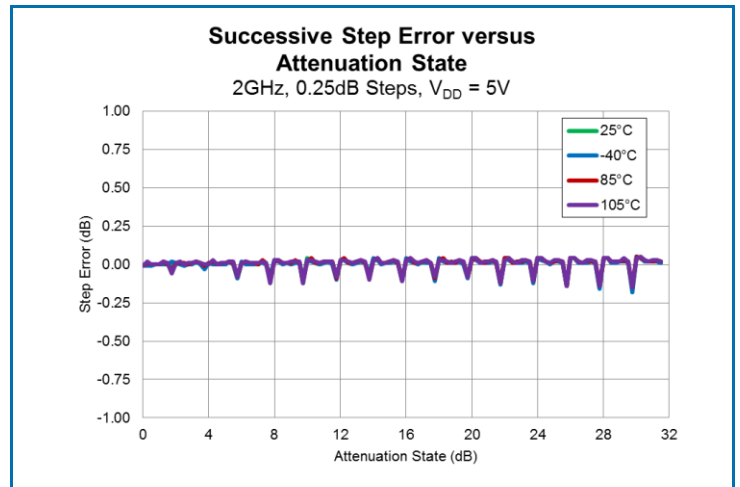
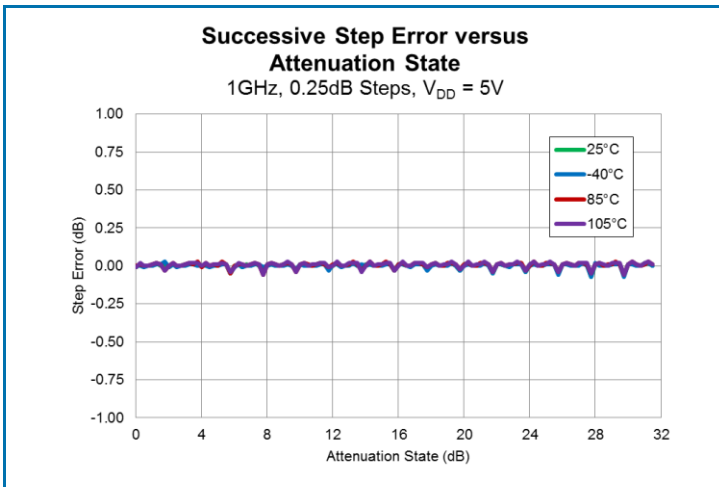
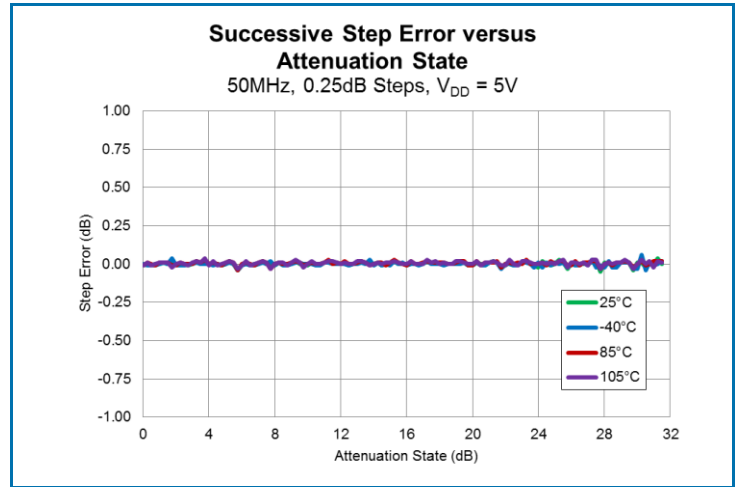
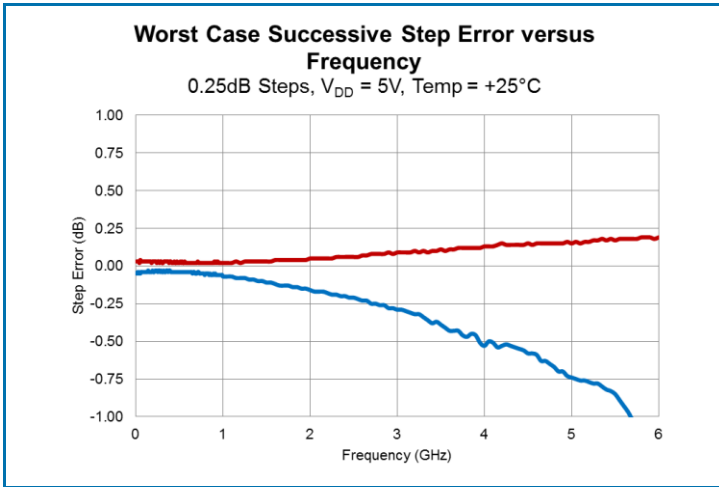

Typical Performance:

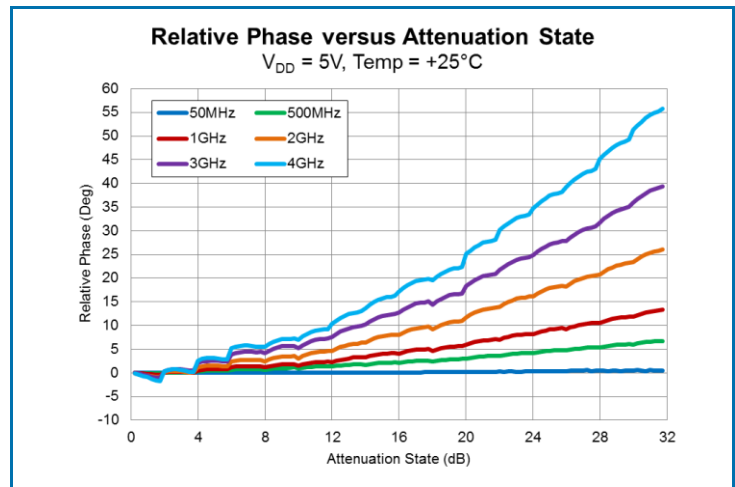
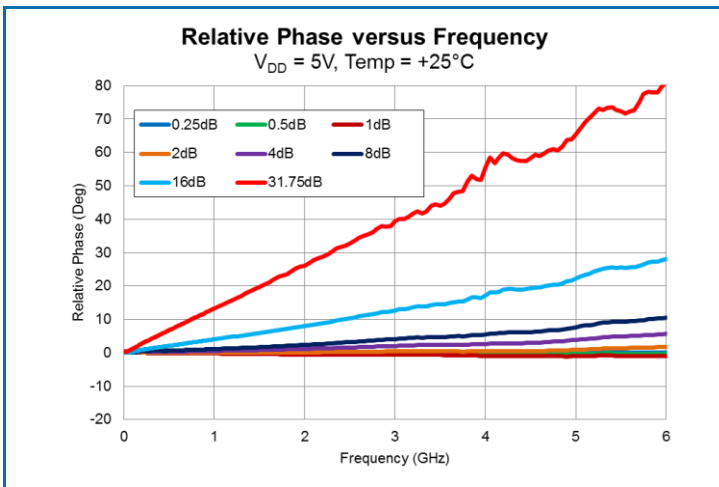
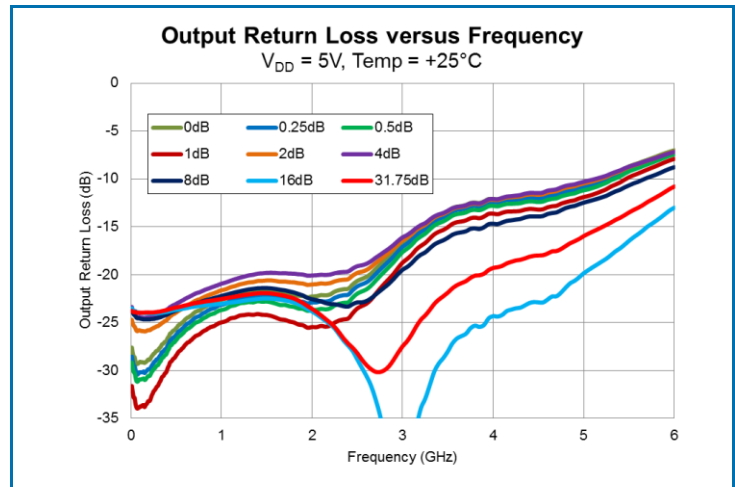
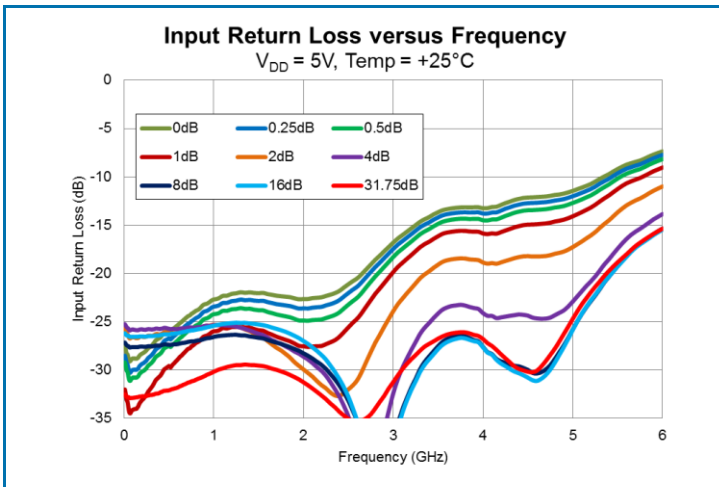
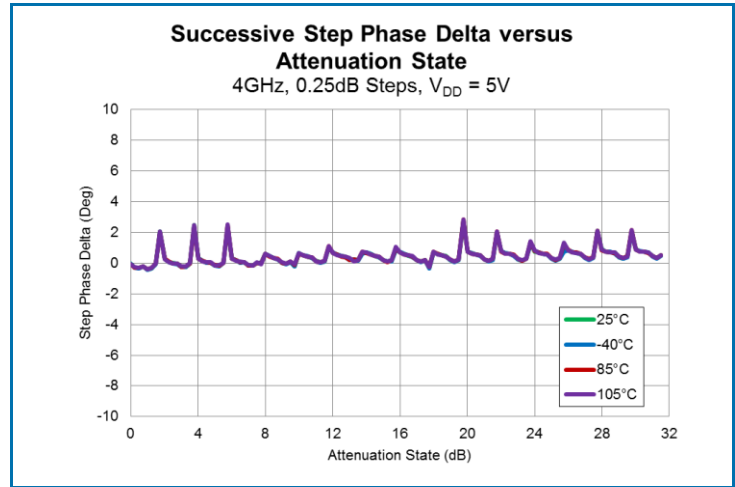
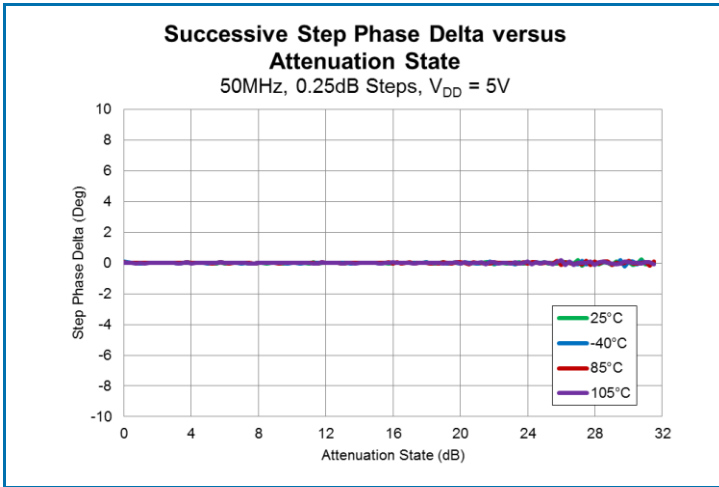

Typical Performance:

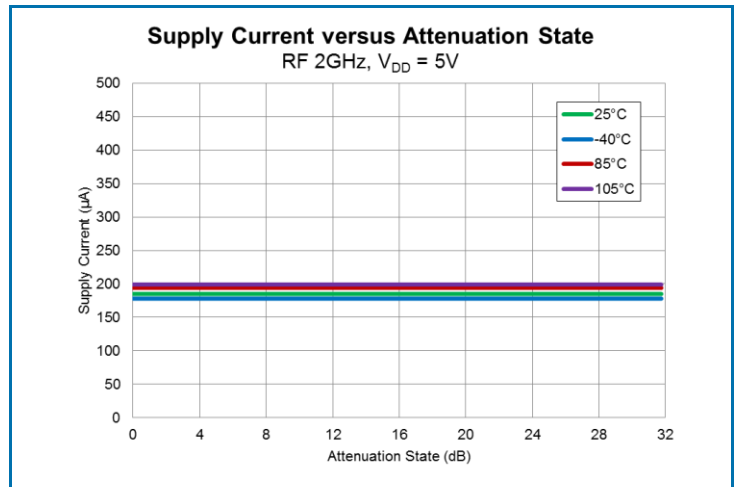
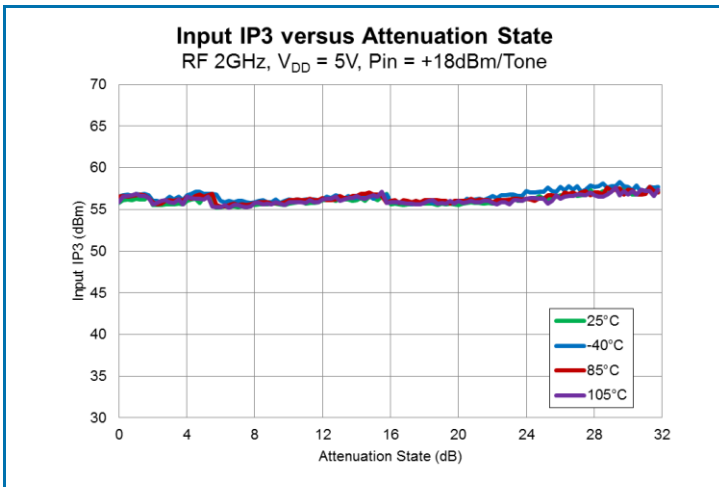
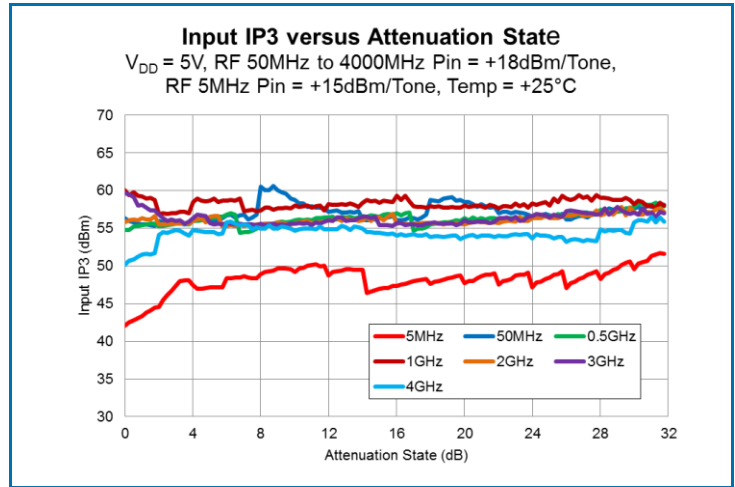
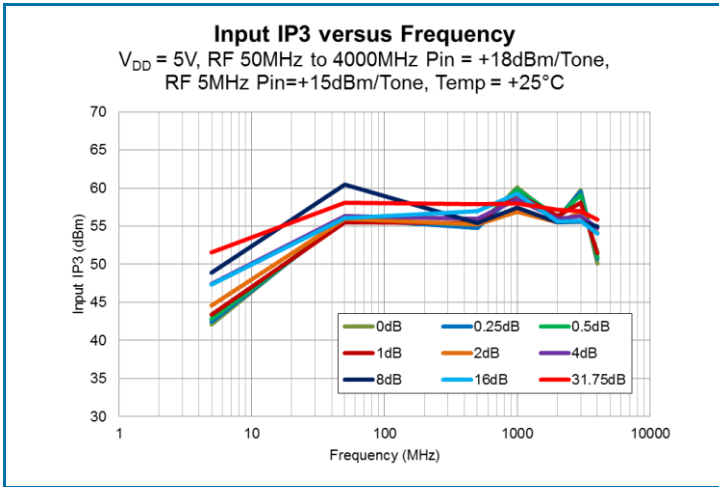



Evaluation Board Schematic

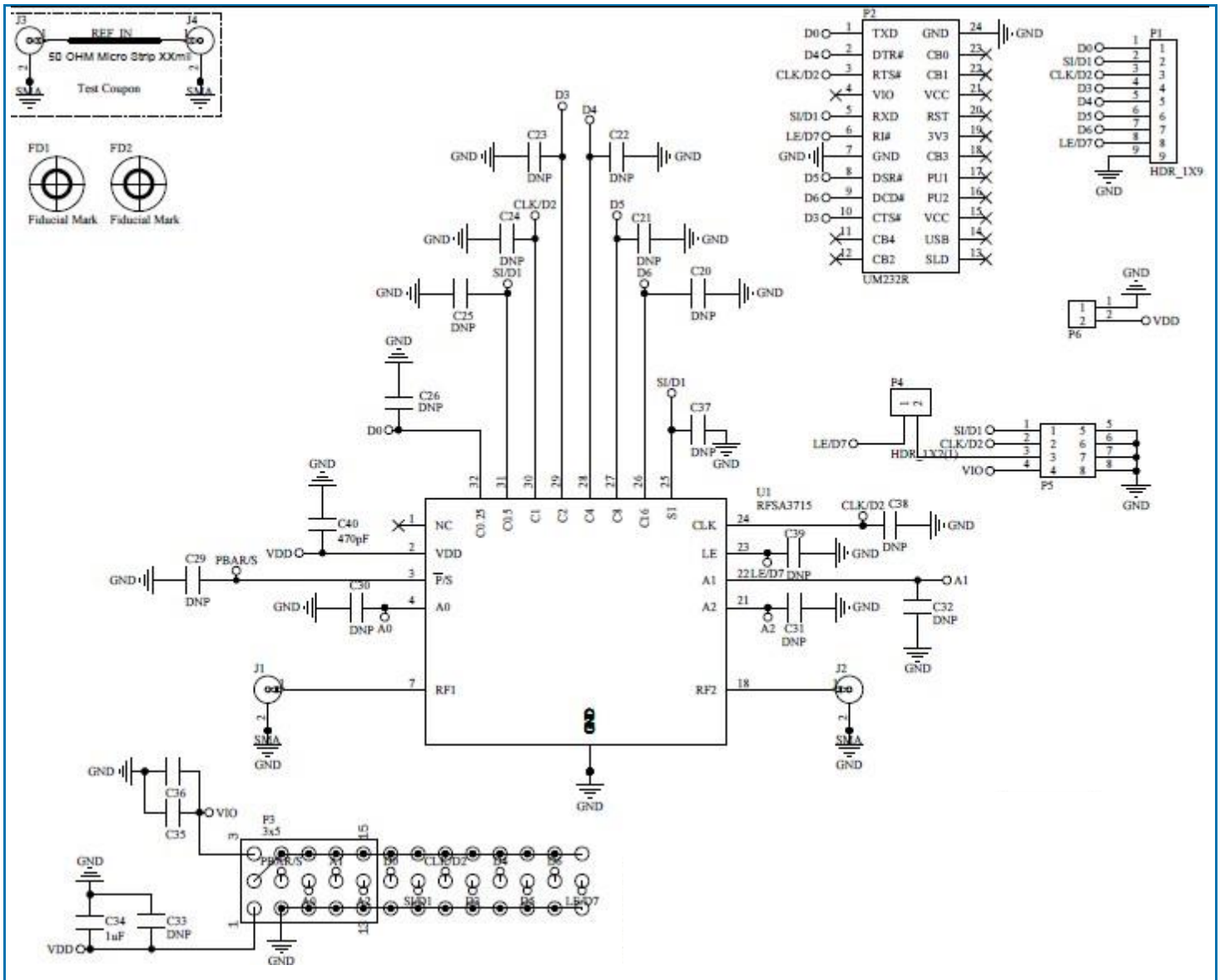

## Evaluation Board Bill of Materials (BOM)

Description	Reference Designator	Manufacturer	Manufacturer's P/N
SA3715-410		Dynamic Details (DDI) Toronto	SA3715-410(D)
Digital Step Attenuator 5MHz to 4000MHz	U1	RFMD	RFSA3715SB
CAP, 1 $\mu$ F, 10%, 25V, X7R, 1206	C34	Taiyo Yuden (USA), Inc.	CE TMK316BJ105KL-T
CONN, SMA, EL FLT VIPER, MAT-21-1038	J1-J4	Amphenol RF Asia Corporation	901-10425
CONN, HDR, ST, 9-PIN, 0.100"	P1	Samtec Inc.	TSW-109-07-G-S
CONN, HDR, ST, PLRZD, 2-PIN, 0.100"	P6	ITW Pancon	24-6518-10
CONN, HDR, ST, 3 x 5, 0.100", T/H	P3	Samtec Inc.	TSW-105-07-L-T
CONN, HDR, ST, 2-PIN, 0.100"	P4	Samtec Inc.	TSW-102-07-G-S
CONN, HDR, 2 x 4, RA, 0.100", T/H	P5	Samtec Inc.	TSW-104-08-G-D-RA
CONN, SKT, 24-PIN DIP, 0.600", T/H	P2	Aries Electronics Inc.	24-6518-10
MOD, USB TO SERIAL UART, SSOP-28	M1 (See Note)	Future Technology Devices Int'l	UM232R
CAP, 470pF, 5%, 50V, C0G, 0402	C40	Murata Electronics	GRM1555C1H471JA01D
Jumper, 2-Pin	S1-S5	3M Interconnect Solutions	929950-00
DNP	C20-C26, C29-C33, C35-C39, S6	N/A	N/A

### Notes:

1. M1 should be mounted into P2 with respect to the Pin 1 alignment of M1 and P2
2. Jumpers S1 thru S5 installed on P3

Evaluation Board Assembly Drawing

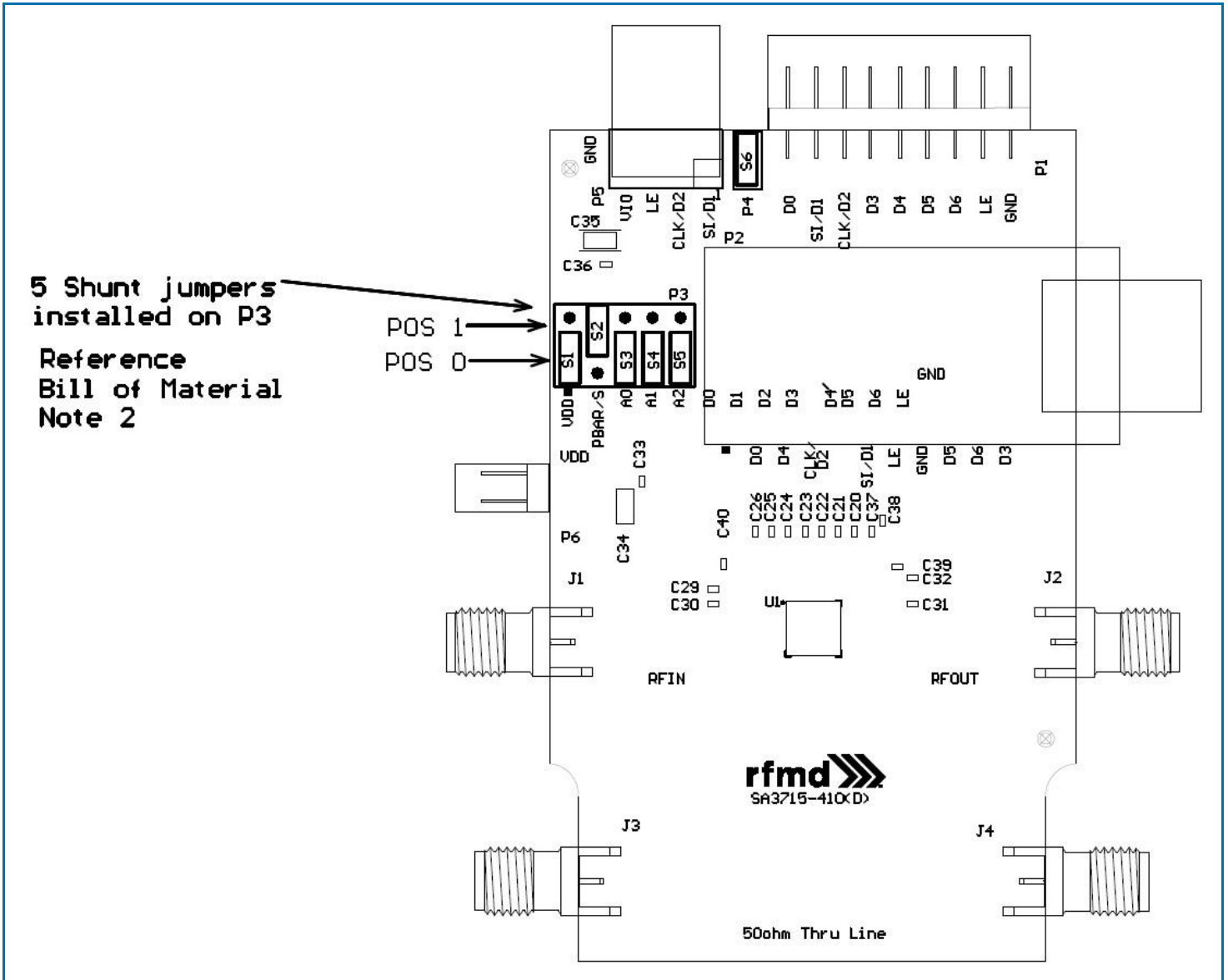

## Evaluation Board Jumper Programming

Jumpers	Connector	Signal	Position	U1 Connection	Comment
S1	P3	Logic Voltage	<b>0</b>	VDD (From P6)	
			1	VIO (From P5)	
S2		PBar/S	0	GND	Parallel Mode
			<b>1</b>	U1_VDD	Serial Mode
S3		AO	<b>0</b>	GND	External Address
			1	U1_VDD	
S4		A1	<b>0</b>	GND	External Address
			1	U1_VDD	
S5		A2	<b>0</b>	GND	External Address
			1	U1_VDD	
S6	P4	LE	<b>OPEN</b>	LE	All Other Modes
			INSTALLED	LE (From P5 Pin 3)	Serial Mode Using P5

Note: Default jumper settings are **BOLD**.

## Evaluation Board Programming Using USB Interface

### Serial Addressable Mode

All programming jumpers on the evaluation board are set to the default values indicated in the table. Refer to the Control Bit Generator (CBG) Software Reference Manual for detailed instructions on how to setup the software for use. Apply the supply voltage to P6. Select 'RFSA3715' from the RFMD parts list of the CBG user interface. Set the attenuation value using the CBG user interface. The attenuator is set to the desired state and measurements can be taken. Note that the external address bits must all be set to '0' when using the USB interface as the CGB software does not have the capability to set the external address in the serial data stream at this time.

### Latched Parallel Mode

Evaluation board programming jumper S2 is set to '0'. All other programming jumpers are not required and can be set to any position. Refer to the Control Bit Generator (CBG) Software Reference Manual for detailed instructions on how to setup the software for use. Apply the supply voltage to P6. Select 'RFSA3715-P' from the RFMD parts list of the CBG user interface. Set the attenuation value using the CBG user interface. The attenuator is set to the desired state and measurements can be taken.

## Evaluation Board Programming Using External Bus

### Serial Addressable Mode

This configuration allows the user to control the attenuator through the P5 connector using an external harness. Remove the USB interface board if it is currently installed on the evaluation board. Connect a user-supplied harness to the P5 connector. Note that the top row of P5 contains the serial bus signals and the bottom row is ground. Programming jumper S1 is set to '0' and S2 is set to '1'. External address jumpers S3 through S5 can be set to any value desired by the user. Jumper S6 is installed and allows the LE signal to be routed from the P5 connector to the attenuator. Apply the supply voltage to P6. Send the appropriate signals onto the serial bus lines in accordance with the Serial Addressable Mode Timing Diagram. The attenuator is set to the desired state and measurements can be taken.

### Latched Parallel Mode

This configuration allows the user to control the attenuator through the P1 connector using an external harness. Remove the USB interface if it is currently installed on the evaluation board. Connect a user-supplied harness to the P1 connector. The parallel bus signal names for P1 are indicated on the evaluation board. Programming jumper S2 is set to '0' to select parallel mode. All other programming jumpers are not required and can be set to any position. Apply the supply voltage to P6. Send the appropriate signals onto the parallel bus lines in accordance with the Latched Parallel Mode Timing Diagram. The attenuator is set to the desired state and measurements can be taken.

### Direct Parallel Mode

This configuration allows the user to control the attenuator through the P1 connector using an external harness. When using this mode the LE signal is held at logic high so that the attenuation will change immediately when there is a change in logic state for any of the parallel bus signals. Remove the USB interface if it is currently installed on the evaluation board. Connect a user-supplied harness to the P1 connector. The parallel bus signal names for P1 are indicated on the evaluation board. Programming jumper S2 is set to '0' to select parallel mode. All other programming jumpers are not required and can be set to any position. Apply the supply voltage to P6. Send the appropriate signals onto the parallel bus lines. The attenuator is set to the desired state and measurements can be taken.

## Default Power-up State

This default attenuation state is maximum (31.75dB) when supply voltage is applied to the attenuator in both serial and parallel modes. If a different attenuation state is desired during power-up, this can be accomplished by applying signals according to the Parallel Mode Truth Table. The attenuator will power-up to the state applied to the parallel bus during turn on. The LE signal must be held to logic '0' during power-up.

## Pin Names and Descriptions

Pin	Name	Description
1	NC	No Connect
2	VDD	Supply Voltage
3	PBAR/S	Mode Select Pin Logic Low = Parallel Logic High = Serial
4	A0	A0 External Address Pin
5	GND	Ground Pin
6	GND	Ground Pin
7	RFIN	RF Input Pin, Incident RF power must enter this pin for rated thermal performance and reliability. Do not apply DC power to this pin. Pin may be DC grounded externally and is grounded thru resistors internal to the part.
8	GND	Ground Pin
9	GND	Ground Pin
10	GND	Ground Pin
11	GND	Ground Pin
12	GND	Ground Pin
13	GND	Ground Pin
14	GND	Ground Pin
15	GND	Ground Pin
16	GND	Ground Pin
17	GND	Ground Pin
18	RFOUT	RF Output Pin; Do not apply DC power to this pin. Pin may be DC grounded externally and is grounded thru resistors internal to the part.
19	GND	Ground Pin
20	GND	Ground Pin
21	A2	A2 External Address Pin
22	A1	A1 External Address Pin
23	LE	Latch Enable, The leading edge of signal on LE causes the attenuator to change setting for serial and latched parallel modes. For direct parallel mode keep LE at a logic high level.
24	CLK	Serial Clock Input
25	SI	Serial Data Input
26	C16	16dB Parallel Control Bit
27	C8	8dB Parallel Control Bit
28	C4	4dB Parallel Control Bit
29	C2	2dB Parallel Control Bit
30	C1	1dB Parallel Control Bit
31	C0.5	0.5dB Parallel Control Bit
32	C0.25	0.25dB Parallel Control Bit

### Serial Addressable Mode Attenuation Word Truth Table

Attenuation Word								Attenuation State
D7	D6	D5	D4	D3	D2	D1	D0 (LSB)	
X	L	L	L	L	L	L	L	0dB / Reference Insertion Loss
X	L	L	L	L	L	L	H	0.25dB
X	L	L	L	L	L	H	L	0.5dB
X	L	L	L	L	H	L	L	1dB
X	L	L	L	H	L	L	L	2dB
X	L	L	H	L	L	L	L	4dB
X	L	H	L	L	L	L	L	8dB
X	H	L	L	L	L	L	L	16dB
X	H	H	H	H	H	H	H	31.75dB

### Serial Addressable Mode Address Word Truth Table

Address Word								Address Setting
A7 (MSB)	A6	A5	A4	A3	A2	A1	A0	
X	X	X	X	X	L	L	L	000
X	X	X	X	X	L	L	H	001
X	X	X	X	X	L	H	L	010
X	X	X	X	X	L	H	H	011
X	X	X	X	X	H	L	L	100
X	X	X	X	X	H	L	H	101
X	X	X	X	X	H	H	L	110
X	X	X	X	X	H	H	H	111

### Serial Addressable Mode Timing Diagram

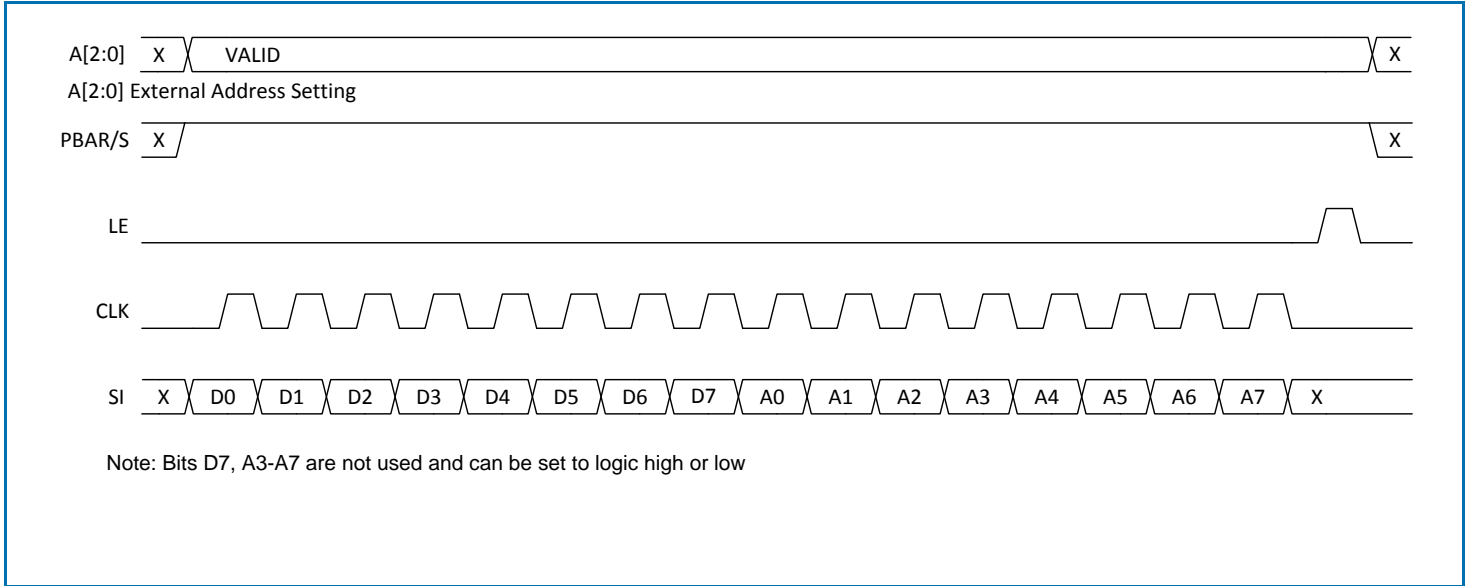



### Parallel Mode Truth Table

Parallel Input Control Setting							Attenuation State
D6 (C16)	D5 (C8)	D4 (C4)	D3 (C2)	D2 (C1)	D1 (C0.5)	D0 (C0.25)	
L	L	L	L	L	L	L	0dB / Reference Insertion Loss
L	L	L	L	L	L	H	0.25dB
L	L	L	L	L	H	L	0.5dB
L	L	L	L	H	L	L	1dB
L	L	L	H	L	L	L	2dB
L	L	H	L	L	L	L	4dB
L	H	L	L	L	L	L	8dB
H	L	L	L	L	L	L	16dB
H	H	H	H	H	H	H	31.75dB

### Latched Parallel Mode Timing Diagram

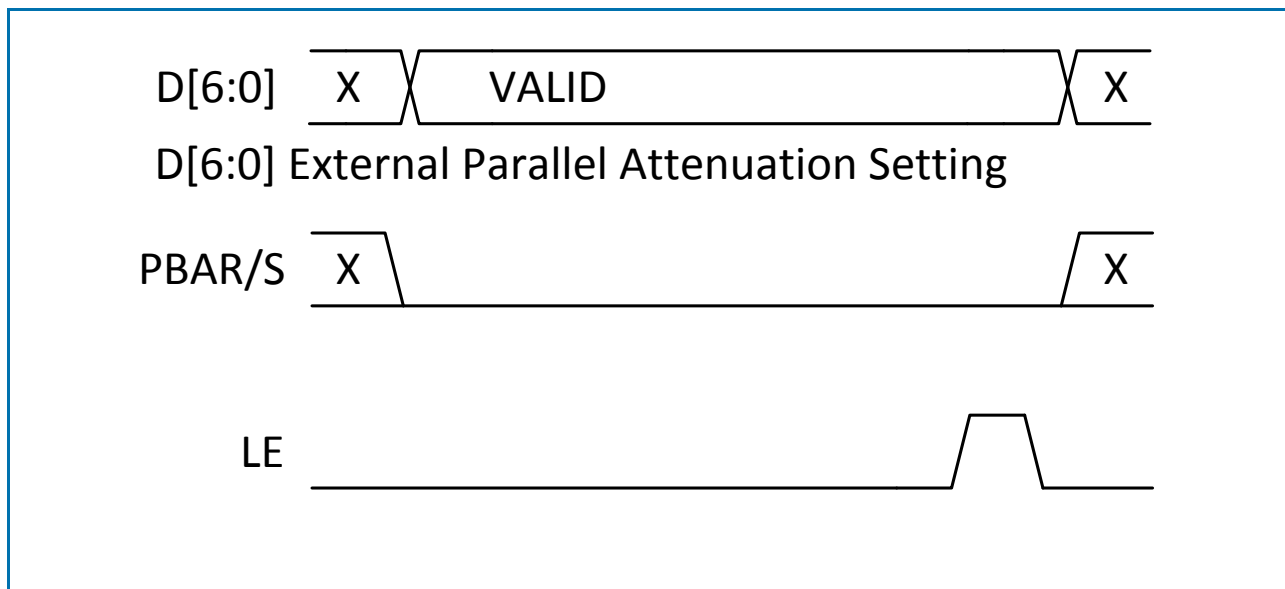

## Serial Bus Timing Specifications

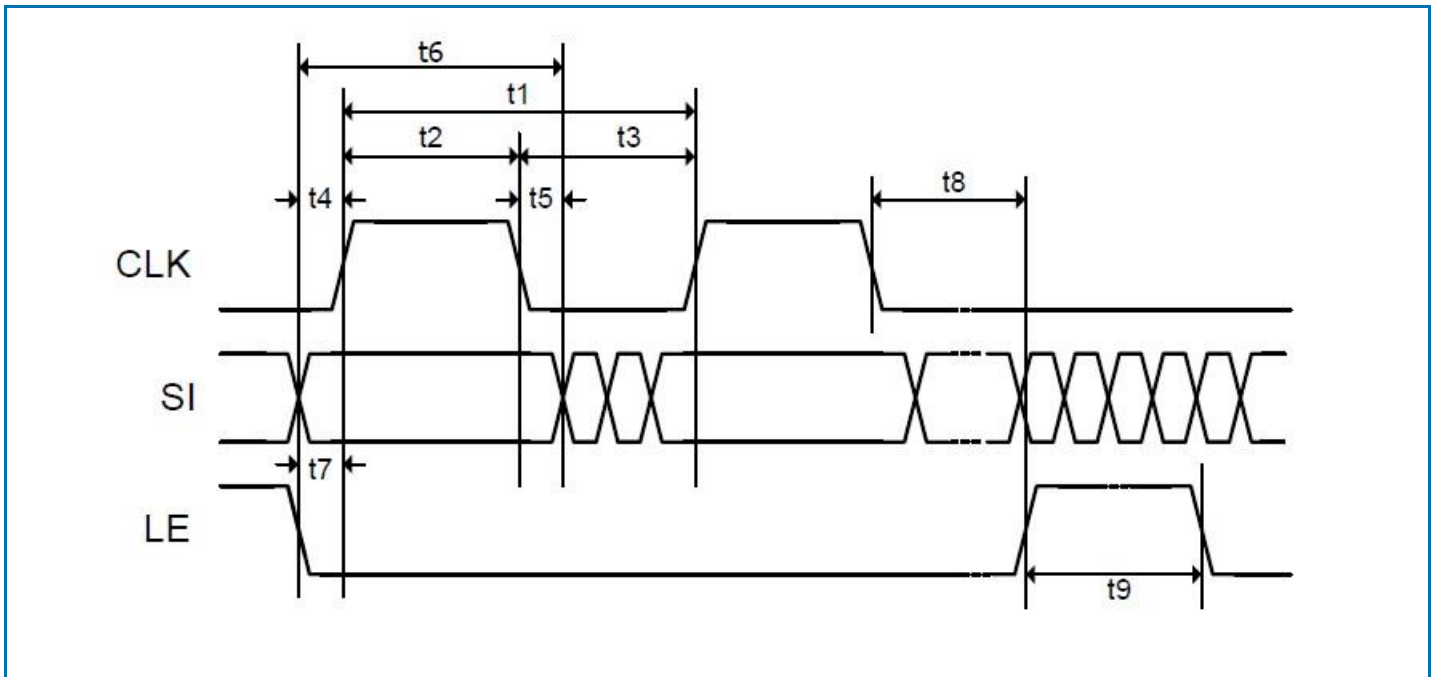

Parameter	Limit	Unit	Comment
$t_1$	25	MHz max	CLK Frequency
$t_2$	20	ns min	CLK High
$t_3$	20	ns min	CLK Low
$t_4$	5	ns min	SI to CLK Setup Time
$t_5$	5	ns min	SI to CLK Hold Time
$t_6$	30	ns min	SI Valid
$t_7$	5	ns min	LE to CLK Setup Time
$t_8$	5	ns min	CLK to LE Setup Time
$t_9$	10	ns min	LE Pulse Width

Package Outline Drawing (Dimensions in millimeters)

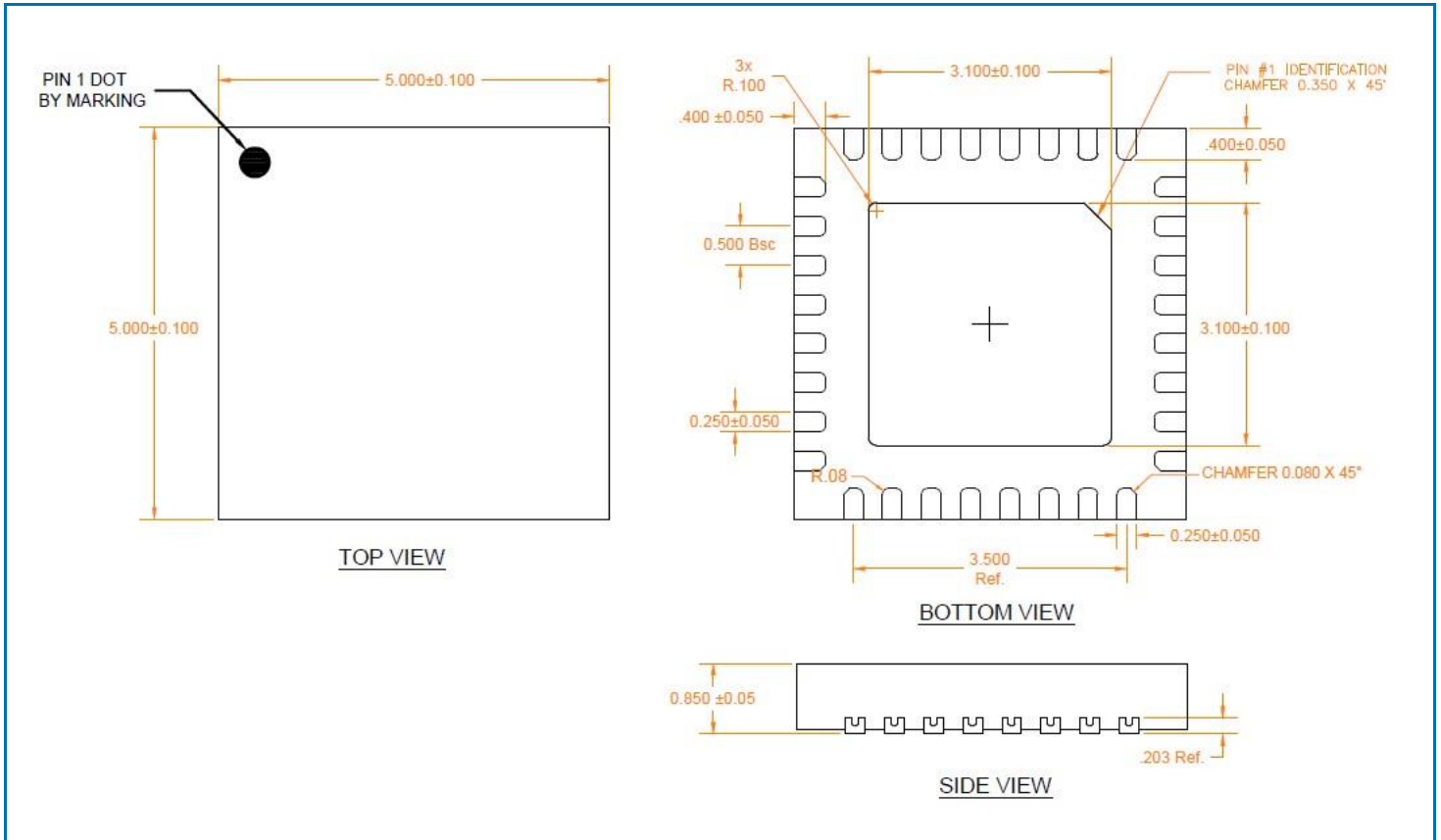

Branding Diagram

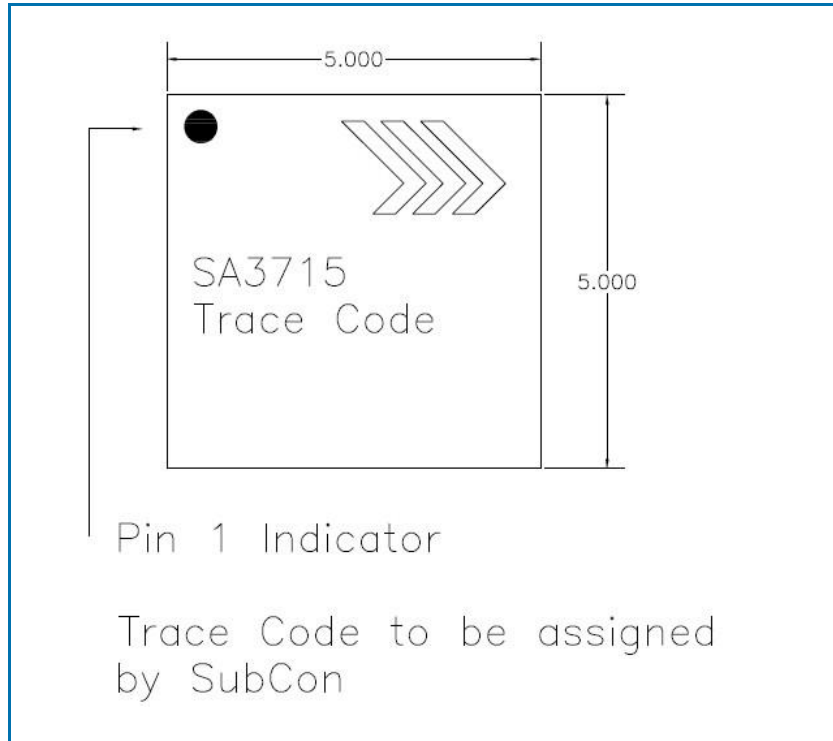

# Mouser Electronics

Authorized Distributor

Click to View Pricing, Inventory, Delivery & Lifecycle Information:

Qorvo:

[RFSA2644SR](#)