

LM2675 SIMPLE SWITCHER[®] Power Converter High Efficiency 1A Step-Down Voltage Regulator

Check for Samples: [LM2675](#)

FEATURES

- Efficiency up to 96%
- Available in SO-8, 8-pin DIP and LLP packages
- Computer Design Software *LM267X Made Simple* (version 6.0)
- Simple and easy to design with
- Requires only 5 external components
- Uses readily available standard inductors
- 3.3V, 5.0V, 12V, and adjustable output versions
- Adjustable version output voltage range: 1.21V to 37V
- $\pm 1.5\%$ max output voltage tolerance over line and load conditions
- Guaranteed 1A output load current
- 0.25 Ω DMOS Output Switch
- Wide input voltage range: 8V to 40V
- 260 kHz fixed frequency internal oscillator
- TTL shutdown capability, low power standby mode
- Thermal shutdown and current limit protection

TYPICAL APPLICATIONS

- Simple High Efficiency (>90%) Step-Down (Buck) Regulator
- Efficient Pre-Regulator for Linear Regulators
- Positive-to-Negative Converter

DESCRIPTION

The LM2675 series of regulators are monolithic integrated circuits built with a LMDMOS process. These regulators provide all the active functions for a step-down (buck) switching regulator, capable of driving a 1A load current with excellent line and load regulation. These devices are available in fixed output voltages of 3.3V, 5.0V, 12V, and an adjustable output version.

Requiring a minimum number of external components, these regulators are simple to use and include patented internal frequency compensation (Patent Nos. 5,382,918 and 5,514,947) and a fixed frequency oscillator.

The LM2675 series operates at a switching frequency of 260 kHz, thus allowing smaller sized filter components than what would be needed with lower frequency switching regulators. Because of its very high efficiency (>90%), the copper traces on the printed circuit board are the only heat sinking needed.

A family of standard inductors for use with the LM2675 are available from several different manufacturers. This feature greatly simplifies the design of switch-mode power supplies using these advanced ICs. Also included in the datasheet are selector guides for diodes and capacitors designed to work in switch-mode power supplies.

Other features include a guaranteed $\pm 1.5\%$ tolerance on output voltage within specified input voltages and output load conditions, and $\pm 10\%$ on the oscillator frequency. External shutdown is included, featuring typically 50 μ A stand-by current. The output switch includes current limiting, as well as thermal shutdown for full protection under fault conditions.

To simplify the LM2675 buck regulator design procedure, there exists computer design software, *LM267X Made Simple* version 6.0.



Please be aware that an important notice concerning availability, standard warranty, and use in critical applications of Texas Instruments semiconductor products and disclaimers thereto appears at the end of this data sheet.

SIMPLE SWITCHER is a registered trademark of Texas Instruments.

Windows is a registered trademark of Microsoft Corporation.

All other trademarks are the property of their respective owners.

Typical Application

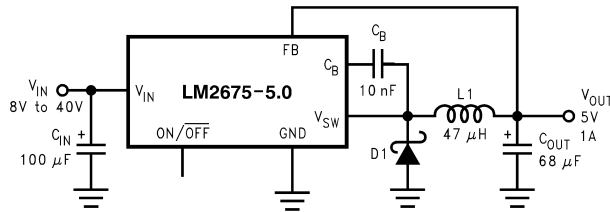

Connection Diagram

16-Lead LLP Surface Mount Package
Top View

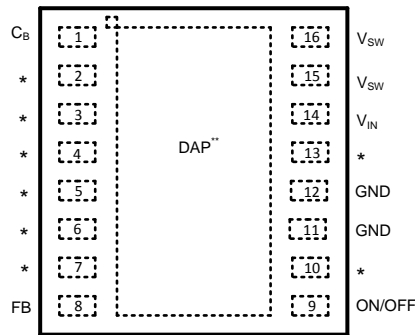

* No Connections
**Connect to Pins 11, 12 on PCB

Figure 1. LLP Package

8-Lead Package
Top View

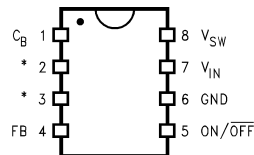

Figure 2. SO-8/DIP Package



These devices have limited built-in ESD protection. The leads should be shorted together or the device placed in conductive foam during storage or handling to prevent electrostatic damage to the MOS gates.

Absolute Maximum Ratings ⁽¹⁾

Supply Voltage	45V
ON/OFF Pin Voltage	$-0.1V \leq V_{SH} \leq 6V$
Switch Voltage to Ground	-1V
Boost Pin Voltage	$V_{SW} + 8V$
Feedback Pin Voltage	$-0.3V \leq V_{FB} \leq 14V$
ESD Susceptibility	
Human Body Model ⁽²⁾	2 kV
Power Dissipation	Internally Limited
Storage Temperature Range	-65°C to +150°C
Lead Temperature	
M Package	
Vapor Phase (60s)	+215°C
Infrared (15s)	+220°C
N Package (Soldering, 10s)	+260°C
LLP Package (See AN-1187)	
Maximum Junction Temperature	+150°C

- (1) Absolute Maximum Ratings indicate limits beyond which damage to the device may occur. Operating Ratings indicate conditions for which the device is intended to be functional, but device parameter specifications may not be guaranteed under these conditions. For guaranteed specifications and test conditions, see the Electrical Characteristics.
- (2) The human body model is a 100 pF capacitor discharged through a 1.5 kΩ resistor into each pin.

Operating Ratings

Supply Voltage	6.5V to 40V
Junction Temperature Range	$-40^{\circ}\text{C} \leq T_J \leq +125^{\circ}\text{C}$

LM2675-3.3 Electrical Characteristics

Specifications with standard type face are for $T_J = 25^\circ\text{C}$, and those with **bold type face** apply over **full Operating Temperature Range**.

Symbol	Parameter	Conditions	Typ ⁽¹⁾	Min ⁽²⁾	Max ⁽²⁾	Units
SYSTEM PARAMETERS Test Circuit Figure 7 ⁽³⁾						
V_{OUT}	Output Voltage	$V_{IN} = 8\text{V to }40\text{V}$, $I_{LOAD} = 20\text{ mA to }1\text{A}$	3.3	3.251/ 3.201	3.350/ 3.399	V
V_{OUT}	Output Voltage	$V_{IN} = 6.5\text{V to }40\text{V}$, $I_{LOAD} = 20\text{ mA to }500\text{ mA}$	3.3	3.251/ 3.201	3.350/ 3.399	V
η	Efficiency	$V_{IN} = 12\text{V}$, $I_{LOAD} = 1\text{A}$	86			%

- (1) Typical numbers are at 25°C and represent the most likely norm.
- (2) All limits guaranteed at room temperature (standard type face) and at **temperature extremes (bold type face)**. All room temperature limits are 100% production tested. All limits at **temperature extremes** are guaranteed via correlation using standard Statistical Quality Control (SQC) methods. All limits are used to calculate Average Outgoing Quality Level (AOQL).
- (3) External components such as the catch diode, inductor, input and output capacitors, and voltage programming resistors can affect switching regulator performance. When the LM2675 is used as shown in [Figure 7](#) [Figure 8](#) test circuits, system performance will be as specified by the system parameters section of the Electrical Characteristics.

LM2675-5.0 Electrical Characteristics

Symbol	Parameter	Conditions	Typ ⁽¹⁾	Min ⁽²⁾	Max ⁽²⁾	Units
SYSTEM PARAMETERS Test Circuit Figure 7 ⁽³⁾						
V_{OUT}	Output Voltage	$V_{IN} = 8\text{V to }40\text{V}$, $I_{LOAD} = 20\text{ mA to }1\text{A}$	5.0	4.925/ 4.850	5.075/ 5.150	V
V_{OUT}	Output Voltage	$V_{IN} = 6.5\text{V to }40\text{V}$, $I_{LOAD} = 20\text{ mA to }500\text{ mA}$	5.0	4.925/ 4.850	5.075/ 5.150	V
η	Efficiency	$V_{IN} = 12\text{V}$, $I_{LOAD} = 1\text{A}$	90			%

- (1) Typical numbers are at 25°C and represent the most likely norm.
- (2) All limits guaranteed at room temperature (standard type face) and at **temperature extremes (bold type face)**. All room temperature limits are 100% production tested. All limits at **temperature extremes** are guaranteed via correlation using standard Statistical Quality Control (SQC) methods. All limits are used to calculate Average Outgoing Quality Level (AOQL).
- (3) External components such as the catch diode, inductor, input and output capacitors, and voltage programming resistors can affect switching regulator performance. When the LM2675 is used as shown in [Figure 7](#) [Figure 8](#) test circuits, system performance will be as specified by the system parameters section of the Electrical Characteristics.

LM2675-12 Electrical Characteristics

Symbol	Parameter	Conditions	Typ ⁽¹⁾	Min ⁽²⁾	Max ⁽²⁾	Units
SYSTEM PARAMETERS Test Circuit Figure 7 ⁽³⁾						
V_{OUT}	Output Voltage	$V_{IN} = 15\text{V to }40\text{V}$, $I_{LOAD} = 20\text{ mA to }1\text{A}$	12	11.82/ 11.64	12.18/ 12.36	V
η	Efficiency	$V_{IN} = 24\text{V}$, $I_{LOAD} = 1\text{A}$	94			%

- (1) Typical numbers are at 25°C and represent the most likely norm.
- (2) All limits guaranteed at room temperature (standard type face) and at **temperature extremes (bold type face)**. All room temperature limits are 100% production tested. All limits at **temperature extremes** are guaranteed via correlation using standard Statistical Quality Control (SQC) methods. All limits are used to calculate Average Outgoing Quality Level (AOQL).
- (3) External components such as the catch diode, inductor, input and output capacitors, and voltage programming resistors can affect switching regulator performance. When the LM2675 is used as shown in [Figure 7](#) [Figure 8](#) test circuits, system performance will be as specified by the system parameters section of the Electrical Characteristics.

LM2675-ADJ Electrical Characteristics

Symbol	Parameter	Conditions	Typ ⁽¹⁾	Min ⁽²⁾	Max ⁽²⁾	Units
SYSTEM PARAMETERS Test Circuit Figure 8 ⁽³⁾						
V_{FB}	Feedback Voltage	$V_{IN} = 8\text{V to }40\text{V}$, $I_{LOAD} = 20\text{ mA to }1\text{A}$ V_{OUT} Programmed for 5V (see Circuit of Figure 8)	1.210	1.192/ 1.174	1.228/ 1.246	V

- (1) Typical numbers are at 25°C and represent the most likely norm.
- (2) All limits guaranteed at room temperature (standard type face) and at **temperature extremes (bold type face)**. All room temperature limits are 100% production tested. All limits at **temperature extremes** are guaranteed via correlation using standard Statistical Quality Control (SQC) methods. All limits are used to calculate Average Outgoing Quality Level (AOQL).
- (3) External components such as the catch diode, inductor, input and output capacitors, and voltage programming resistors can affect switching regulator performance. When the LM2675 is used as shown in [Figure 7](#) [Figure 8](#) test circuits, system performance will be as specified by the system parameters section of the Electrical Characteristics.

LM2675-ADJ Electrical Characteristics (continued)

Symbol	Parameter	Conditions	Typ ⁽¹⁾	Min ⁽²⁾	Max ⁽²⁾	Units
V _{FB}	Feedback Voltage	V _{IN} = 6.5V to 40V, I _{LOAD} = 20 mA to 500 mA V _{OUT} Programmed for 5V (see Circuit of Figure 8)	1.210	1.192/1.174	1.228/1.246	V
η	Efficiency	V _{IN} = 12V, I _{LOAD} = 1A	90			%

All Output Voltage Versions Electrical Characteristics

Specifications with standard type face are for $T_J = 25^\circ\text{C}$, and those with **bold type face** apply over **full Operating Temperature Range**. Unless otherwise specified, $V_{IN} = 12\text{V}$ for the 3.3V, 5V, and Adjustable versions and $V_{IN} = 24\text{V}$ for the 12V version, and $I_{LOAD} = 100\text{ mA}$.

Symbol	Parameters	Conditions	Typ	Min	Max	Units
DEVICE PARAMETERS						
I_Q	Quiescent Current	$V_{FEEDBACK} = 8\text{V}$	2.5		3.6	mA
		For 3.3V, 5.0V, and ADJ Versions				
		$V_{FEEDBACK} = 15\text{V}$	2.5			mA
		For 12V Versions				
I_{STBY}	Standby Quiescent Current	ON/OFF Pin = 0V	50		100/ 150	μA
I_{CL}	Current Limit		1.55	1.25/ 1.2	2.1/ 2.2	A
I_L	Output Leakage Current	$V_{IN} = 40\text{V}$, ON/OFF Pin = 0V $V_{SWITCH} = 0\text{V}$	1		25	μA
		$V_{SWITCH} = -1\text{V}$, ON/OFF Pin = 0V	6		15	mA
$R_{DS(ON)}$	Switch On-Resistance	$I_{SWITCH} = 1\text{A}$	0.25		0.30/ 0.50	Ω
f_O	Oscillator Frequency	Measured at Switch Pin	260	225	275	kHz
D	Maximum Duty Cycle		95			%
	Minimum Duty Cycle		0			%
I_{BIAS}	Feedback Bias Current	$V_{FEEDBACK} = 1.3\text{V}$ ADJ Version Only	85			nA
$V_{S/D}$	ON/OFF Pin Voltage Thesholds		1.4	0.8	2.0	V
$I_{S/D}$	ON/OFF Pin Current	ON/OFF Pin = 0V	20	7	37	μA
θ_{JA}	Thermal Resistance	N Package, Junction to Ambient ⁽¹⁾	95			$^\circ\text{C/W}$
		M Package, Junction to Ambient ⁽¹⁾	105			

- (1) Junction to ambient thermal resistance with approximately 1 square inch of printed circuit board copper surrounding the leads. Additional copper area will lower thermal resistance further. See Application Information section in the application note accompanying this datasheet and the thermal model in **LM267X Made Simple** software (version 6.0). The value θ_{J-A} for the LLP (LD) package is specifically dependent on PCB trace area, trace material, and the number of layers and thermal vias. For improved thermal resistance and power dissipation for the LLP package, refer to Application Note AN-1187.

Typical Performance Characteristics

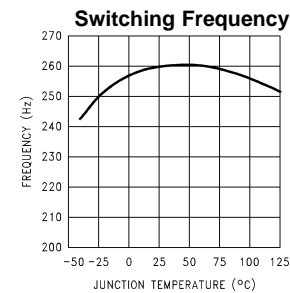
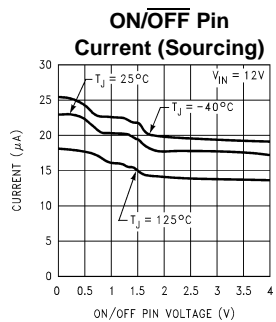
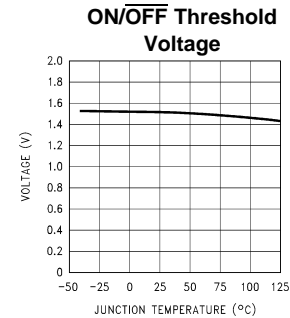
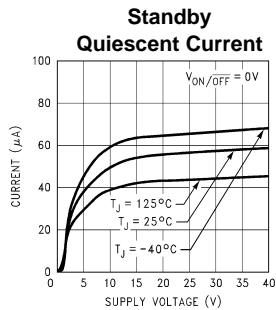
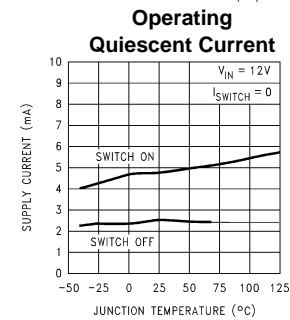
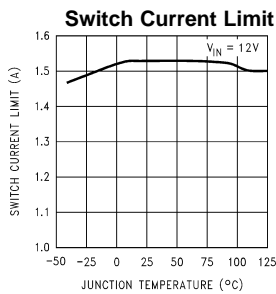
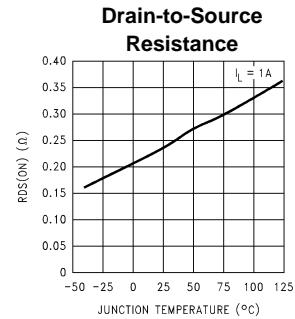
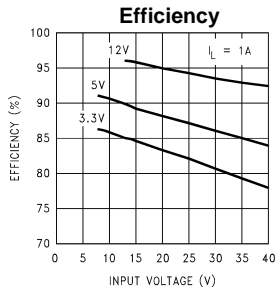
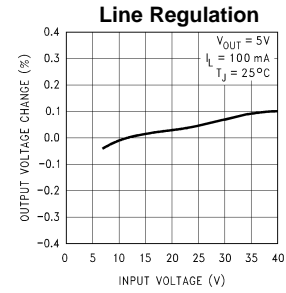
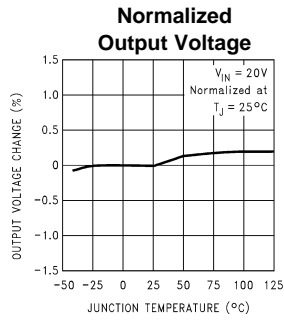

Typical Performance Characteristics (continued)

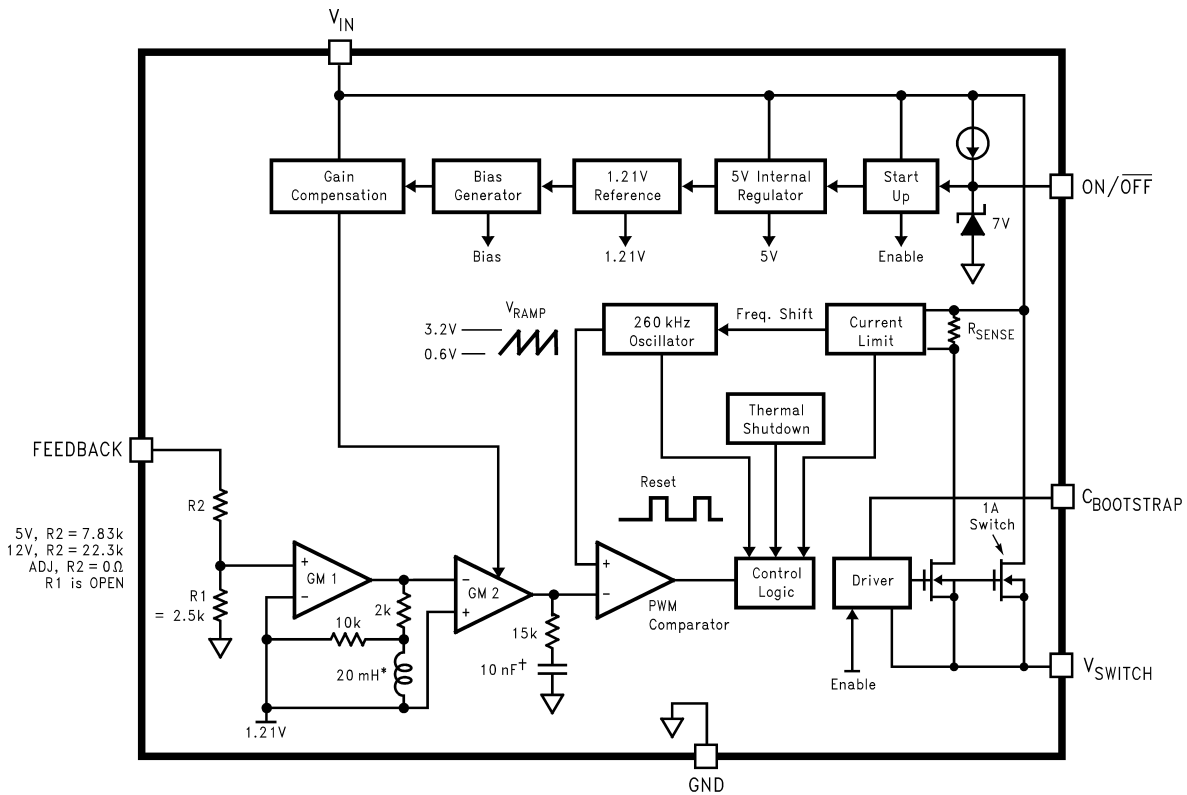
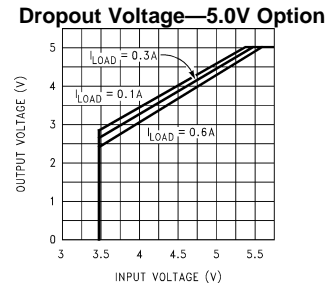
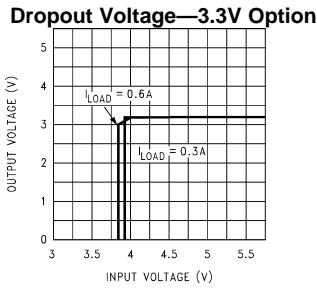
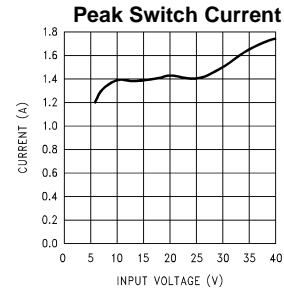
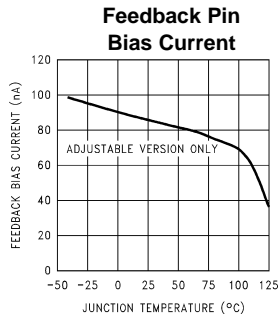

* Active Inductor Patent Number 5,514,947
 † Active Capacitor Patent Number 5,382,918

Typical Performance Characteristics

(Circuit of [Figure 7](#))

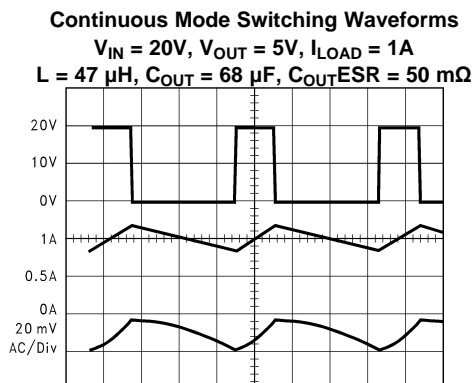

A: V_{SW} Pin Voltage, 10 V/div.
 B: Inductor Current, 0.5 A/div
 C: Output Ripple Voltage, 20 mV/div AC-Coupled

Figure 3. Horizontal Time Base: 1 μs /div

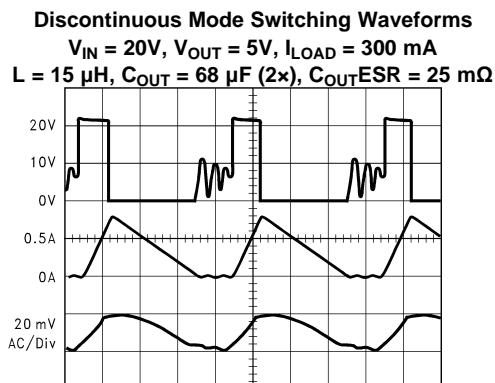

A: V_{SW} Pin Voltage, 10 V/div.
 B: Inductor Current, 0.5 A/div
 C: Output Ripple Voltage, 20 mV/div AC-Coupled

Figure 4. Horizontal Time Base: 1 μs /div

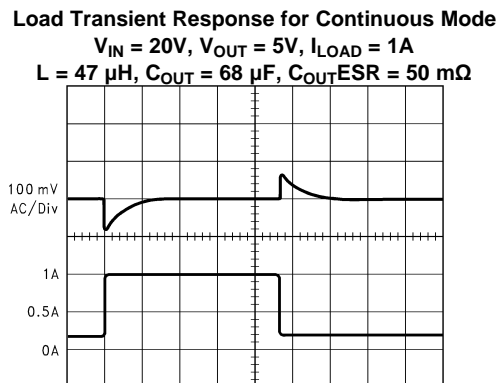

A: Output Voltage, 100 mV/div, AC-Coupled.
 B: Load Current: 200 mA to 1A Load Pulse

Figure 5. Horizontal Time Base: 50 μs /div

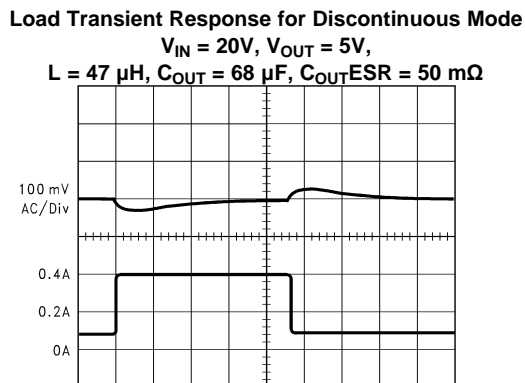

A: Output Voltage, 100 mV/div, AC-Coupled.
 B: Load Current: 100 mA to 400 mA Load Pulse

Figure 6. Horizontal Time Base: 200 μs /div

Test Circuit and Layout Guidelines

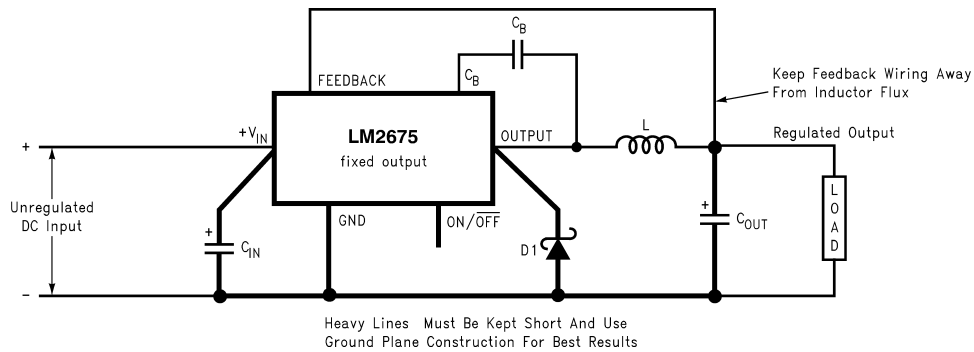

C_{IN} - 22 μF , 50V Tantalum, Sprague "199D Series"
 C_{OUT} - 47 μF , 25V Tantalum, Sprague "595D Series"
 D1 - 3.3A, 50V Schottky Rectifier, IR 30WQ05F
 L1 - 68 μH Sumida #RCR110D-680L
 C_B - 0.01 μF , 50V Ceramic

**Figure 7. Standard Test Circuits and Layout Guides
Fixed Output Voltage Versions**

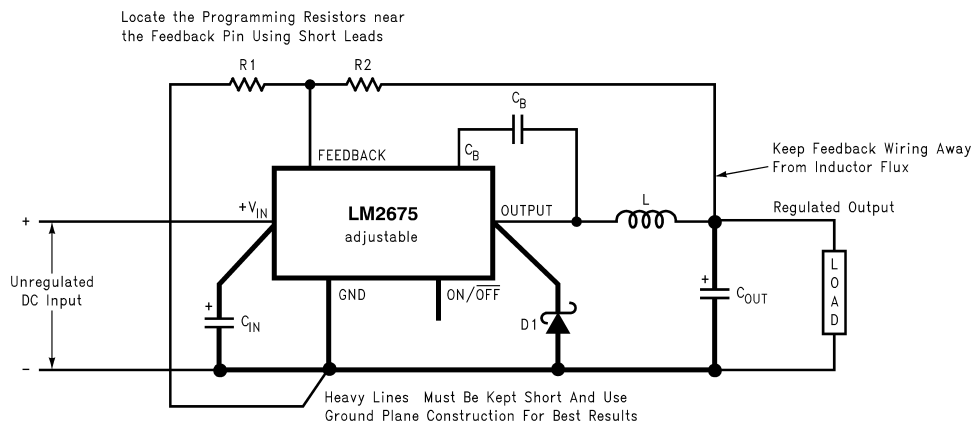

C_{IN} - 22 μF , 50V Tantalum, Sprague "199D Series"
 C_{OUT} - 47 μF , 25V Tantalum, Sprague "595D Series"
 D1 - 3.3A, 50V Schottky Rectifier, IR 30WQ05F
 L1 - 68 μH Sumida #RCR110D-680L
 R_1 - 1.5 k Ω , 1%
 C_B - 0.01 μF , 50V Ceramic
 For a 5V output, select R_2 to be 4.75 k Ω , 1%

$$V_{OUT} = V_{REF} \left(1 + \frac{R_2}{R_1} \right)$$

where $V_{REF} = 1.21\text{V}$

$$R_2 = R_1 \left(\frac{V_{OUT}}{V_{REF}} - 1 \right)$$

Use a 1% resistor for best stability.

**Figure 8. Standard Test Circuits and Layout Guides
Adjustable Output Voltage Version**

LM2675 Series Buck Regulator Design Procedure (Fixed Output)

PROCEDURE (Fixed Output Voltage Version)	EXAMPLE (Fixed Output Voltage Version)
<p>To simplify the buck regulator design procedure, National Semiconductor is making available computer design software to be used with the SIMPLE SWITCHER line of switching regulators. LM267X Made Simple version 6.0 is available on Windows® 3.1, NT, or 95 operating systems.</p>	
Given:	Given:
V_{OUT} = Regulated Output Voltage (3.3V, 5V, or 12V)	V_{OUT} = 5V
$V_{IN(max)}$ = Maximum DC Input Voltage	$V_{IN(max)}$ = 12V
$I_{LOAD(max)}$ = Maximum Load Current	$I_{LOAD(max)}$ = 1A
1. Inductor Selection (L1)	1. Inductor Selection (L1)
<p>A. Select the correct inductor value selection guide from Figure 9, Figure 10 or Figure 11 (output voltages of 3.3V, 5V, or 12V respectively). For all other voltages, see the design procedure for the adjustable version.</p>	<p>A. Use the inductor selection guide for the 5V version shown in Figure 10.</p>
<p>B. From the inductor value selection guide, identify the inductance region intersected by the Maximum Input Voltage line and the Maximum Load Current line. Each region is identified by an inductance value and an inductor code (LXX).</p>	<p>B. From the inductor value selection guide shown in Figure 10, the inductance region intersected by the 12V horizontal line and the 1A vertical line is 33 μH, and the inductor code is L23.</p>
<p>C. Select an appropriate inductor from the four manufacturer's part numbers listed in Inductor Value Selection Guides. Each manufacturer makes a different style of inductor to allow flexibility in meeting various design requirements. Listed below are some of the differentiating characteristics of each manufacturer's inductors:</p>	<p>C. The inductance value required is 33 μH. From the table in Table 1, go to the L23 line and choose an inductor part number from any of the four manufacturers shown. (In most instances, both through hole and surface mount inductors are available.)</p>
<p><i>Schott</i>: ferrite EP core inductors; these have very low leakage magnetic fields to reduce electro-magnetic interference (EMI) and are the lowest power loss inductors</p>	
<p><i>Renco</i>: ferrite stick core inductors; benefits are typically lowest cost inductors and can withstand E•T and transient peak currents above rated value. Be aware that these inductors have an external magnetic field which may generate more EMI than other types of inductors.</p>	
<p><i>Pulse</i>: powdered iron toroid core inductors; these can also be low cost and can withstand larger than normal E•T and transient peak currents. Toroid inductors have low EMI.</p>	
<p><i>Coilcraft</i>: ferrite drum core inductors; these are the smallest physical size inductors, available only as SMT components. Be aware that these inductors also generate EMI—but less than stick inductors.</p>	
<p>Complete specifications for these inductors are available from the respective manufacturers. A table listing the manufacturers' phone numbers is located in Table 2.</p>	
2. Output Capacitor Selection (C_{OUT})	2. Output Capacitor Selection (C_{OUT})
<p>A. Select an output capacitor from the output capacitor table in Table 3. Using the output voltage and the inductance value found in the inductor selection guide, step 1, locate the appropriate capacitor value and voltage rating.</p>	<p>A. Use the 5.0V section in the output capacitor table in Table 3. Choose a capacitor value and voltage rating from the line that contains the inductance value of 33 μH. The capacitance and voltage rating values corresponding to the 33 μH inductor are the:</p>
<p>The capacitor list contains through-hole electrolytic capacitors from four different capacitor manufacturers and surface mount tantalum capacitors from two different capacitor manufacturers. It is recommended that both the manufacturers and the manufacturer's series that are listed in the table be used. A table listing the manufacturers' phone numbers is located in Table 2.</p>	<p>Surface Mount: 68 μF/10V Sprague 594D Series. 100 μF/10V AVX TPS Series. Through Hole: 68 μF/10V Sanyo OS-CON SA Series. 220 μF/35V Sanyo MV-GX Series. 220 μF/35V Nichicon PL Series. 220 μF/35V Panasonic HFQ Series.</p>

PROCEDURE (Fixed Output Voltage Version)	EXAMPLE (Fixed Output Voltage Version)
<p>3. Catch Diode Selection (D1)</p> <p>A. In normal operation, the average current of the catch diode is the load current times the catch diode duty cycle, $1-D$ (D is the switch duty cycle, which is approximately the output voltage divided by the input voltage). The largest value of the catch diode average current occurs at the maximum load current and maximum input voltage (minimum D). For normal operation, the catch diode current rating must be at least 1.3 times greater than its maximum average current. However, if the power supply design must withstand a continuous output short, the diode should have a current rating equal to the maximum current limit of the LM2675. The most stressful condition for this diode is a shorted output condition.</p> <p>B. The reverse voltage rating of the diode should be at least 1.25 times the maximum input voltage.</p> <p>C. Because of their fast switching speed and low forward voltage drop, Schottky diodes provide the best performance and efficiency. This Schottky diode must be located close to the LM2675 using short leads and short printed circuit traces.</p>	<p>3. Catch Diode Selection (D1)</p> <p>A. Refer to the table shown in Table 5. In this example, a 1A, 20V Schottky diode will provide the best performance. If the circuit must withstand a continuous shorted output, a higher current Schottky diode is recommended.</p>
<p>4. Input Capacitor (C_{IN})</p> <p>A low ESR aluminum or tantalum bypass capacitor is needed between the input pin and ground to prevent large voltage transients from appearing at the input. This capacitor should be located close to the IC using short leads. In addition, the RMS current rating of the input capacitor should be selected to be at least $\frac{1}{2}$ the DC load current. The capacitor manufacturer data sheet must be checked to assure that this current rating is not exceeded. The curves shown in Figure 13 show typical RMS current ratings for several different aluminum electrolytic capacitor values. A parallel connection of two or more capacitors may be required to increase the total minimum RMS current rating to suit the application requirements. For an aluminum electrolytic capacitor, the voltage rating should be at least 1.25 times the maximum input voltage. Caution must be exercised if solid tantalum capacitors are used. The tantalum capacitor voltage rating should be twice the maximum input voltage. The tables in Table 3 show the recommended application voltage for AVX TPS and Sprague 594D tantalum capacitors. It is also recommended that they be surge current tested by the manufacturer. The TPS series available from AVX, and the 593D and 594D series from Sprague are all surge current tested. Another approach to minimize the surge current stresses on the input capacitor is to add a small inductor in series with the input supply line. Use caution when using ceramic capacitors for input bypassing, because it may cause severe ringing at the V_{IN} pin.</p>	<p>4. Input Capacitor (C_{IN})</p> <p>The important parameters for the input capacitor are the input voltage rating and the RMS current rating. With a maximum input voltage of 12V, an aluminum electrolytic capacitor with a voltage rating greater than 15V ($1.25 \times V_{IN}$) would be needed. The next higher capacitor voltage rating is 16V. The RMS current rating requirement for the input capacitor in a buck regulator is approximately $\frac{1}{2}$ the DC load current. In this example, with a 1A load, a capacitor with a RMS current rating of at least 500 mA is needed. The curves shown in Figure 13 can be used to select an appropriate input capacitor. From the curves, locate the 16V line and note which capacitor values have RMS current ratings greater than 500 mA. For a through hole design, a 330 μF/16V electrolytic capacitor (Panasonic HFQ series, Nichicon PL, Sanyo MV-GX series or equivalent) would be adequate. Other types or other manufacturers' capacitors can be used provided the RMS ripple current ratings are adequate. Additionally, for a complete surface mount design, electrolytic capacitors such as the Sanyo CV-C or CV-BS and the Nichicon WF or UR and the NIC Components NACZ series could be considered. For surface mount designs, solid tantalum capacitors can be used, but caution must be exercised with regard to the capacitor surge current rating and voltage rating. In this example, checking Table 8, and the Sprague 594D series datasheet, a Sprague 594D 15 μF, 25V capacitor is adequate.</p>
<p>5. Boost Capacitor (C_B)</p> <p>This capacitor develops the necessary voltage to turn the switch gate on fully. All applications should use a 0.01 μF, 50V ceramic capacitor.</p>	<p>5. Boost Capacitor (C_B)</p> <p>For this application, and all applications, use a 0.01 μF, 50V ceramic capacitor.</p>

Inductor Value Selection Guides
(For Continuous Mode Operation)

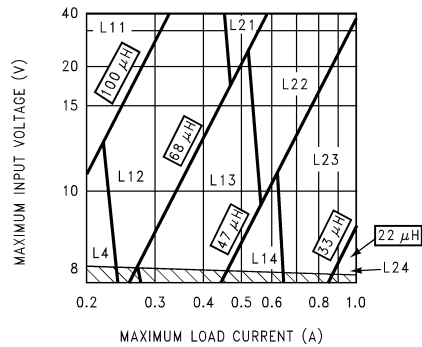

Figure 9. LM2675-3.3

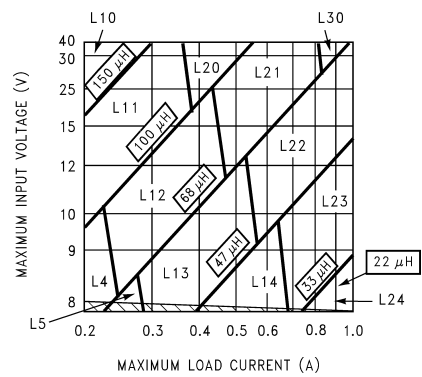

Figure 10. LM2675-5.0

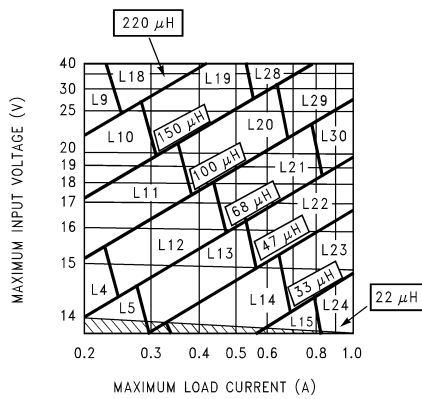

Figure 11. LM2675-12

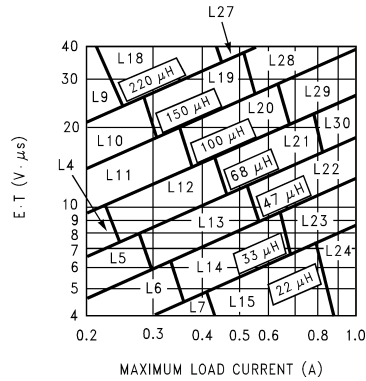

Figure 12. LM2675-ADJ

Table 1. Inductor Manufacturers' Part Numbers

Ind. Ref. Desg.	Inductance (μH)	Current (A)	Schott		Renco		Pulse Engineering		Coilcraft
			Through	Surface	Through	Surface	Through	Surface	Surface
			Hole	Mount	Hole	Mount	Hole	Mount	Mount
L4	68	0.32	67143940	67144310	RL-1284-68-43	RL1500-68	PE-53804	PE-53804-S	DO1608-683
L5	47	0.37	67148310	67148420	RL-1284-47-43	RL1500-47	PE-53805	PE-53805-S	DO1608-473
L6	33	0.44	67148320	67148430	RL-1284-33-43	RL1500-33	PE-53806	PE-53806-S	DO1608-333
L7	22	0.52	67148330	67148440	RL-1284-22-43	RL1500-22	PE-53807	PE-53807-S	DO1608-223
L9	220	0.32	67143960	67144330	RL-5470-3	RL1500-220	PE-53809	PE-53809-S	DO3308-224
L10	150	0.39	67143970	67144340	RL-5470-4	RL1500-150	PE-53810	PE-53810-S	DO3308-154
L11	100	0.48	67143980	67144350	RL-5470-5	RL1500-100	PE-53811	PE-53811-S	DO3308-104
L12	68	0.58	67143990	67144360	RL-5470-6	RL1500-68	PE-53812	PE-53812-S	DO3308-683
L13	47	0.70	67144000	67144380	RL-5470-7	RL1500-47	PE-53813	PE-53813-S	DO3308-473
L14	33	0.83	67148340	67148450	RL-1284-33-43	RL1500-33	PE-53814	PE-53814-S	DO3308-333
L15	22	0.99	67148350	67148460	RL-1284-22-43	RL1500-22	PE-53815	PE-53815-S	DO3308-223
L18	220	0.55	67144040	67144420	RL-5471-2	RL1500-220	PE-53818	PE-53818-S	DO3316-224
L19	150	0.66	67144050	67144430	RL-5471-3	RL1500-150	PE-53819	PE-53819-S	DO3316-154
L20	100	0.82	67144060	67144440	RL-5471-4	RL1500-100	PE-53820	PE-53820-S	DO3316-104
L21	68	0.99	67144070	67144450	RL-5471-5	RL1500-68	PE-53821	PE-53821-S	DO3316-683
L22	47	1.17	67144080	67144460	RL-5471-6	—	PE-53822	PE-53822-S	DO3316-473
L23	33	1.40	67144090	67144470	RL-5471-7	—	PE-53823	PE-53823-S	DO3316-333
L24	22	1.70	67148370	67148480	RL-1283-22-43	—	PE-53824	PE-53824-S	DO3316-223
L27	220	1.00	67144110	67144490	RL-5471-2	—	PE-53827	PE-53827-S	DO5022P-224
L28	150	1.20	67144120	67144500	RL-5471-3	—	PE-53828	PE-53828-S	DO5022P-154
L29	100	1.47	67144130	67144510	RL-5471-4	—	PE-53829	PE-53829-S	DO5022P-104
L30	68	1.78	67144140	67144520	RL-5471-5	—	PE-53830	PE-53830-S	DO5022P-683

Table 2. Inductor Manufacturers' Phone Numbers

Coilcraft Inc.	Phone	(800) 322-2645
	FAX	(708) 639-1469
Coilcraft Inc., Europe	Phone	+44 1236 730 595
	FAX	+44 1236 730 627
Pulse Engineering Inc.	Phone	(619) 674-8100
	FAX	(619) 674-8262
Pulse Engineering Inc.,	Phone	+353 93 24 107

Table 2. Inductor Manufacturers' Phone Numbers (continued)

Europe	FAX	+353 93 24 459
Renco Electronics Inc.	Phone	(800) 645-5828
	FAX	(516) 586-5562
Schott Corp.	Phone	(612) 475-1173
	FAX	(612) 475-1786

Table 3. Output Capacitor Table

Output Voltage (V)	Inductance (μH)	Output Capacitor					
		Surface Mount		Through Hole			
		Sprague	AVX TPS	Sanyo OS-CON	Sanyo MV-GX	Nichicon	Panasonic
		594D Series	Series	SA Series	Series	PL Series	HFQ Series
		(μF/V)	(μF/V)	(μF/V)	(μF/V)	(μF/V)	(μF/V)
3.3	22	120/6.3	100/10	100/10	330/35	330/35	330/35
	33	120/6.3	100/10	68/10	220/35	220/35	220/35
	47	68/10	100/10	68/10	150/35	150/35	150/35
	68	120/6.3	100/10	100/10	120/35	120/35	120/35
	100	120/6.3	100/10	100/10	120/35	120/35	120/35
	150	120/6.3	100/10	100/10	120/35	120/35	120/35
5.0	22	100/16	100/10	100/10	330/35	330/35	330/35
	33	68/10	100/10	68/10	220/35	220/35	220/35
	47	68/10	100/10	68/10	150/35	150/35	150/35
	68	100/16	100/10	100/10	120/35	120/35	120/35
	100	100/16	100/10	100/10	120/35	120/35	120/35
	150	100/16	100/10	100/10	120/35	120/35	120/35
12	22	120/20	(2×) 68/20	68/20	330/35	330/35	330/35
	33	68/25	68/20	68/20	220/35	220/35	220/35
	47	47/20	68/20	47/20	150/35	150/35	150/35
	68	47/20	68/20	47/20	120/35	120/35	120/35
	100	47/20	68/20	47/20	120/35	120/35	120/35
	150	47/20	68/20	47/20	120/35	120/35	120/35
	220	47/20	68/20	47/20	120/35	120/35	120/35

Table 4. Capacitor Manufacturers' Phone Numbers

Nichicon Corp.	Phone	(847) 843-7500
	FAX	(847) 843-2798
Panasonic	Phone	(714) 373-7857
	FAX	(714) 373-7102
AVX Corp.	Phone	(803) 448-9411
	FAX	(803) 448-1943
Sprague/Vishay	Phone	(207) 324-4140
	FAX	(207) 324-7223
Sanyo Corp.	Phone	(619) 661-6322
	FAX	(619) 661-1055

Table 5. Schottky Diode Selection Table

V _R	1A Diodes		3A Diodes	
	Surface	Through	Surface	Through
	Mount	Hole	Mount	Hole
20V	SK12	1N5817	SK32	1N5820
	B120	SR102		SR302
30V	SK13	1N5818	SK33	1N5821
	B130	11DQ03	30WQ03F	31DQ03
	MBRS130	SR103		
40V	SK14	1N5819	SK34	1N5822
	B140	11DQ04	30BQ040	MBR340
	MBRS140	SR104	30WQ04F	31DQ04
	10BQ040		MBRS340	SR304
	10MQ040		MBRD340	
50V	SK15	MBR150	SK35	MBR350
	B150	11DQ05	30WQ05F	31DQ05
	10BQ050	SR105		SR305

Table 6. Diode Manufacturers' Phone Numbers

International Rectifier Corp.	Phone	(310) 322-3331
	FAX	(310) 322-3332
Motorola, Inc.	Phone	(800) 521-6274
	FAX	(602) 244-6609
General Instruments Corp.	Phone	(516) 847-3000
	FAX	(516) 847-3236
Diodes, Inc.	Phone	(805) 446-4800
	FAX	(805) 446-4850

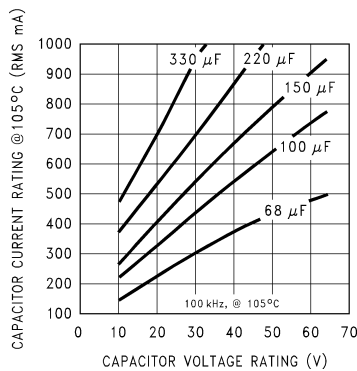

Figure 13. RMS Current Ratings for Low ESR Electrolytic Capacitors (Typical)

Table 7. AVX TPS

Recommended Application Voltage	Voltage Rating
+85°C Rating	
3.3	6.3
5	10

Table 7. AVX TPS (continued)

Recommended	Voltage
Application Voltage	Rating
+85°C Rating	
10	20
12	25
15	35

Table 8. Sprague 594D

Recommended	Voltage
Application Voltage	Rating
+85°C Rating	
2.5	4
3.3	6.3
5	10
8	16
12	20
18	25
24	35
29	50

LM2675 Series Buck Regulator Design Procedure (Adjustable Output)

PROCEDURE (Adjustable Output Voltage Version)	EXAMPLE (Adjustable Output Voltage Version)
<p>To simplify the buck regulator design procedure, National Semiconductor is making available computer design software to be used with the SIMPLE SWITCHER line of switching regulators. LM2675X Made Simple version 6.0 is available for use on Windows® 3.1, NT, or 95 operating systems.</p>	
Given:	Given:
V _{OUT} = Regulated Output Voltage	V _{OUT} = 20V
V _{IN(max)} = Maximum Input Voltage	V _{IN(max)} = 28V
I _{LOAD(max)} = Maximum Load Current	I _{LOAD(max)} = 1A
F = Switching Frequency (Fixed at a nominal 260 kHz).	F = Switching Frequency (Fixed at a nominal 260 kHz).
1. Programming Output Voltage (Selecting R ₁ and R ₂ , as shown in Figure 8)	1. Programming Output Voltage (Selecting R ₁ and R ₂ , as shown in Figure 8)
Use the following formula to select the appropriate resistor values.	Select R ₁ to be 1 kΩ, 1%. Solve for R ₂ .
$V_{OUT} = V_{REF} \left(1 + \frac{R_2}{R_1} \right) \text{ where } V_{REF} = 1.21V \quad (1)$	$R_2 = R_1 \left(\frac{V_{OUT}}{V_{REF}} - 1 \right) = 1 \text{ k}\Omega \left(\frac{20V}{1.23V} - 1 \right) \quad (2)$
Select a value for R ₁ between 240Ω and 1.5 kΩ. The lower resistor values minimize noise pickup in the sensitive feedback pin. (For the lowest temperature coefficient and the best stability with time, use 1% metal film resistors.)	R ₂ = 1k (16.53 - 1) = 15.53 kΩ, closest 1% value is 15.4 kΩ. R ₂ = 15.4 kΩ.
$R_2 = R_1 \left(\frac{V_{OUT}}{V_{REF}} - 1 \right) \quad (3)$	
2. Inductor Selection (L1)	2. Inductor Selection (L1)
A. Calculate the inductor Volt • microsecond constant E • T (V • μs), from the following formula:	A. Calculate the inductor Volt • microsecond constant (E • T),
$E \cdot T = (V_{IN(MAX)} - V_{OUT} - V_{SAT}) \cdot \frac{V_{OUT} + V_D}{V_{IN(MAX)} - V_{SAT} + V_D} \cdot \frac{1000}{260} (V \cdot \mu s) \quad (4)$	$E \cdot T = (28 - 20 - 0.25) \cdot \frac{20 + 0.5}{28 - 0.25 + 0.5} \cdot \frac{1000}{260} (V \cdot \mu s)$ $E \cdot T = (7.75) \cdot \frac{20.5}{28.25} \cdot 3.85 (V \cdot \mu s) = 21.6 (V \cdot \mu s) \quad (5)$

PROCEDURE (Adjustable Output Voltage Version)	EXAMPLE (Adjustable Output Voltage Version)
where V_{SAT} = internal switch saturation voltage = 0.25V and V_D = diode forward voltage drop = 0.5V	
B. Use the $E \cdot T$ value from the previous formula and match it with the $E \cdot T$ number on the vertical axis of the Inductor Value Selection Guide shown in Figure 12 .	B. $E \cdot T = 21.6 (V \cdot \mu s)$
C. On the horizontal axis, select the maximum load current.	C. $I_{LOAD(max)} = 1A$
D. Identify the inductance region intersected by the $E \cdot T$ value and the Maximum Load Current value. Each region is identified by an inductance value and an inductor code (LXX).	D. From the inductor value selection guide shown in Figure 12 , the inductance region intersected by the 21.6 ($V \cdot \mu s$) horizontal line and the 1A vertical line is 68 μH , and the inductor code is L30.
E. Select an appropriate inductor from the four manufacturer's part numbers listed in Table 1 . For information on the different types of inductors, see the inductor selection in the fixed output voltage design procedure.	E. From the table in Table 1 , locate line L30, and select an inductor part number from the list of manufacturers part numbers.
3. Output Capacitor Selection (C_{OUT})	3. Output Capacitor Selection (C_{OUT})
A. Select an output capacitor from the capacitor code selection guide in Table 9 . Using the inductance value found in the inductor selection guide, step 1, locate the appropriate capacitor code corresponding to the desired output voltage.	A. Use the appropriate row of the capacitor code selection guide, in Table 9 . For this example, use the 15–20V row. The capacitor code corresponding to an inductance of 68 μH is C20.
B. Select an appropriate capacitor value and voltage rating, using the capacitor code, from the output capacitor selection table in Table 10 . There are two solid tantalum (surface mount) capacitor manufacturers and four electrolytic (through hole) capacitor manufacturers to choose from. It is recommended that both the manufacturers and the manufacturer's series that are listed in the table be used. A table listing the manufacturers' phone numbers is located in Table 4 .	B. From the output capacitor selection table in Table 10 , choose a capacitor value (and voltage rating) that intersects the capacitor code(s) selected in section A, C20. The capacitance and voltage rating values corresponding to the capacitor code C20 are the: Surface Mount: 33 $\mu F/25V$ Sprague 594D Series. 33 $\mu F/25V$ AVX TPS Series. Through Hole: 33 $\mu F/25V$ Sanyo OS-CON SC Series. 120 $\mu F/35V$ Sanyo MV-GX Series. 120 $\mu F/35V$ Nichicon PL Series. 120 $\mu F/35V$ Panasonic HFQ Series. Other manufacturers or other types of capacitors may also be used, provided the capacitor specifications (especially the 100 kHz ESR) closely match the characteristics of the capacitors listed in the output capacitor table. Refer to the capacitor manufacturers' data sheet for this information.
4. Catch Diode Selection (D1)	4. Catch Diode Selection (D1)
A. In normal operation, the average current of the catch diode is the load current times the catch diode duty cycle, 1-D (D is the switch duty cycle, which is approximately V_{OUT}/V_{IN}). The largest value of the catch diode average current occurs at the maximum input voltage (minimum D). For normal operation, the catch diode current rating must be at least 1.3 times greater than its maximum average current. However, if the power supply design must withstand a continuous output short, the diode should have a current rating greater than the maximum current limit of the LM2675. The most stressful condition for this diode is a shorted output condition.	A. Refer to the table shown in Table 5 . Schottky diodes provide the best performance, and in this example a 1A, 40V Schottky diode would be a good choice. If the circuit must withstand a continuous shorted output, a higher current (at least 2.2A) Schottky diode is recommended.
B. The reverse voltage rating of the diode should be at least 1.25 times the maximum input voltage.	
C. Because of their fast switching speed and low forward voltage drop, Schottky diodes provide the best performance and efficiency. The Schottky diode must be located close to the LM2675 using short leads and short printed circuit traces.	

PROCEDURE (Adjustable Output Voltage Version)	EXAMPLE (Adjustable Output Voltage Version)
<p>5. Input Capacitor (C_{IN}) A low ESR aluminum or tantalum bypass capacitor is needed between the input pin and ground to prevent large voltage transients from appearing at the input. This capacitor should be located close to the IC using short leads. In addition, the RMS current rating of the input capacitor should be selected to be at least ½ the DC load current. The capacitor manufacturer data sheet must be checked to assure that this current rating is not exceeded. The curves shown in Figure 13 show typical RMS current ratings for several different aluminum electrolytic capacitor values. A parallel connection of two or more capacitors may be required to increase the total minimum RMS current rating to suit the application requirements. For an aluminum electrolytic capacitor, the voltage rating should be at least 1.25 times the maximum input voltage. Caution must be exercised if solid tantalum capacitors are used. The tantalum capacitor voltage rating should be twice the maximum input voltage. Table 7 and Table 8 show the recommended application voltage for AVX TPS and Sprague 594D tantalum capacitors. It is also recommended that they be surge current tested by the manufacturer. The TPS series available from AVX, and the 593D and 594D series from Sprague are all surge current tested. Another approach to minimize the surge current stresses on the input capacitor is to add a small inductor in series with the input supply line. Use caution when using ceramic capacitors for input bypassing, because it may cause severe ringing at the V_{IN} pin.</p>	<p>5. Input Capacitor (C_{IN}) The important parameters for the input capacitor are the input voltage rating and the RMS current rating. With a maximum input voltage of 28V, an aluminum electrolytic capacitor with a voltage rating of at least 35V (1.25 × V_{IN}) would be needed. The RMS current rating requirement for the input capacitor in a buck regulator is approximately ½ the DC load current. In this example, with a 1A load, a capacitor with a RMS current rating of at least 500 mA is needed. The curves shown in Figure 13 can be used to select an appropriate input capacitor. From the curves, locate the 35V line and note which capacitor values have RMS current ratings greater than 500 mA. For a through hole design, a 330 μF/35V electrolytic capacitor (Panasonic HFQ series, Nichicon PL, Sanyo MV-GX series or equivalent) would be adequate. Other types or other manufacturers' capacitors can be used provided the RMS ripple current ratings are adequate. Additionally, for a complete surface mount design, electrolytic capacitors such as the Sanyo CV-C or CV-BS, and the Nichicon WF or UR and the NIC Components NACZ series could be considered. For surface mount designs, solid tantalum capacitors can be used, but caution must be exercised with regard to the capacitor surge current rating and voltage rating. In this example, checking Table 8, and the Sprague 594D series datasheet, a Sprague 594D 15 μF, 50V capacitor is adequate.</p>
<p>6. Boost Capacitor (C_B) This capacitor develops the necessary voltage to turn the switch gate on fully. All applications should use a 0.01 μF, 50V ceramic capacitor.</p>	<p>6. Boost Capacitor (C_B) For this application, and all applications, use a 0.01 μF, 50V ceramic capacitor.</p>

Table 9. Capacitor Code Selection Guide

Case Style ⁽¹⁾	Output Voltage (V)	Inductance (μH)						
		22	33	47	68	100	150	220
SM and TH	1.21–2.50	—	—	—	—	C1	C2	C3
SM and TH	2.50–3.75	—	—	—	C1	C2	C3	C3
SM and TH	3.75–5.0	—	—	C4	C5	C6	C6	C6
SM and TH	5.0–6.25	—	C4	C7	C6	C6	C6	C6
SM and TH	6.25–7.5	C8	C4	C7	C6	C6	C6	C6
SM and TH	7.5–10.0	C9	C10	C11	C12	C13	C13	C13
SM and TH	10.0–12.5	C14	C11	C12	C12	C13	C13	C13
SM and TH	12.5–15.0	C15	C16	C17	C17	C17	C17	C17
SM and TH	15.0–20.0	C18	C19	C20	C20	C20	C20	C20
SM and TH	20.0–30.0	C21	C22	C22	C22	C22	C22	C22
TH	30.0–37.0	C23	C24	C24	C25	C25	C25	C25

(1) SM - Surface Mount, TH - Through Hole

Table 10. Output Capacitor Selection Table

Cap. Ref. Desg. #	Output Capacitor					
	Surface Mount		Through Hole			
	Sprague	AVX TPS	Sanyo OS-CON	Sanyo MV-GX	Nichicon	Panasonic
	594D Series	Series	SA Series	Series	PL Series	HFQ Series
	(μF/V)	(μF/V)	(μF/V)	(μF/V)	(μF/V)	(μF/V)
C1	120/6.3	100/10	100/10	220/35	220/35	220/35
C2	120/6.3	100/10	100/10	150/35	150/35	150/35
C3	120/6.3	100/10	100/35	120/35	120/35	120/35
C4	68/10	100/10	68/10	220/35	220/35	220/35
C5	100/16	100/10	100/10	150/35	150/35	150/35

Table 10. Output Capacitor Selection Table (continued)

Cap. Ref. Desg. #	Output Capacitor					
	Surface Mount		Through Hole			
	Sprague	AVX TPS	Sanyo OS-CON	Sanyo MV-GX	Nichicon	Panasonic
	594D Series ($\mu\text{F/V}$)	Series ($\mu\text{F/V}$)	SA Series ($\mu\text{F/V}$)	Series ($\mu\text{F/V}$)	PL Series ($\mu\text{F/V}$)	HFQ Series ($\mu\text{F/V}$)
C6	100/16	100/10	100/10	120/35	120/35	120/35
C7	68/10	100/10	68/10	150/35	150/35	150/35
C8	100/16	100/10	100/10	330/35	330/35	330/35
C9	100/16	100/16	100/16	330/35	330/35	330/35
C10	100/16	100/16	68/16	220/35	220/35	220/35
C11	100/16	100/16	68/16	150/35	150/35	150/35
C12	100/16	100/16	68/16	120/35	120/35	120/35
C13	100/16	100/16	100/16	120/35	120/35	120/35
C14	100/16	100/16	100/16	220/35	220/35	220/35
C15	47/20	68/20	47/20	220/35	220/35	220/35
C16	47/20	68/20	47/20	150/35	150/35	150/35
C17	47/20	68/20	47/20	120/35	120/35	120/35
C18	68/25	(2x) 33/25	47/25 ⁽¹⁾	220/35	220/35	220/35
C19	33/25	33/25	33/25 ⁽¹⁾	150/35	150/35	150/35
C20	33/25	33/25	33/25 ⁽¹⁾	120/35	120/35	120/35
C21	33/35	(2x) 22/25	⁽²⁾	150/35	150/35	150/35
C22	33/35	22/35	⁽²⁾	120/35	120/35	120/35
C23	⁽²⁾	⁽²⁾	⁽²⁾	220/50	100/50	120/50
C24	⁽²⁾	⁽²⁾	⁽²⁾	150/50	100/50	120/50
C25	⁽²⁾	⁽²⁾	⁽²⁾	150/50	82/50	82/50

(1) The SC series of Os-Con capacitors (others are SA series)

(2) The voltage ratings of the surface mount tantalum chip and Os-Con capacitors are too low to work at these voltages.

Application Information

TYPICAL SURFACE MOUNT PC BOARD LAYOUT, FIXED OUTPUT (4X SIZE)

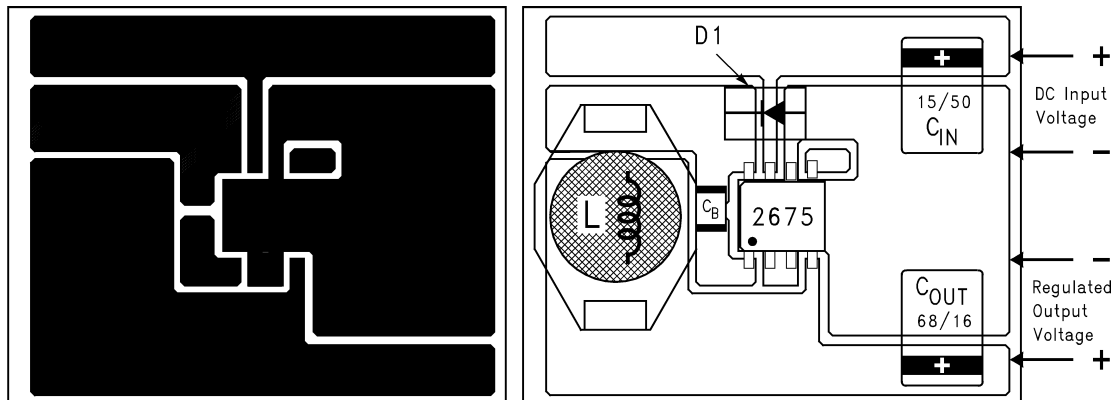

- C_{IN} - 15 μF , 50V, Solid Tantalum Sprague, "594D series"
- C_{OUT} - 68 μF , 16V, Solid Tantalum Sprague, "594D series"
- D1 - 1A, 40V Schottky Rectifier, Surface Mount
- L1 - 33 μH , L23, Coilcraft DO3316
- C_B - 0.01 μF , 50V, Ceramic

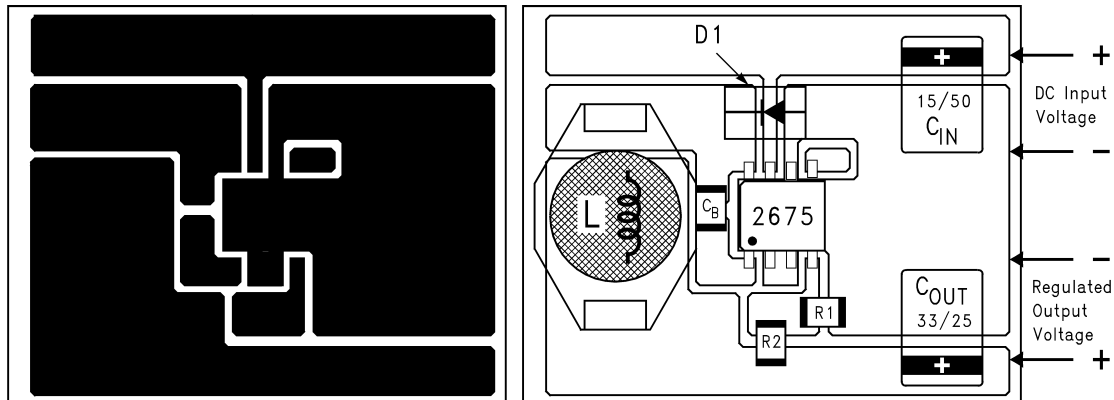
TYPICAL SURFACE MOUNT PC BOARD LAYOUT, ADJUSTABLE OUTPUT (4X SIZE)

C_{IN} - 15 μ F, 50V, Solid Tantalum Sprague, "594D series"
 C_{OUT} - 33 μ F, 25V, Solid Tantalum Sprague, "594D series"
 D1 - 1A, 40V Schottky Rectifier, Surface Mount
 L1 - 68 μ H, L30, Coilcraft DO3316
 C_B - 0.01 μ F, 50V, Ceramic
 R1 - 1k, 1%
 R2 - Use formula in Design Procedure

Figure 14. PC Board Layout

Layout is very important in switching regulator designs. Rapidly switching currents associated with wiring inductance can generate voltage transients which can cause problems. For minimal inductance and ground loops, the wires indicated by **heavy lines (in Figure 7 and Figure 8)** should be **wide printed circuit traces and should be kept as short as possible**. For best results, external components should be located as close to the switcher IC as possible using ground plane construction or single point grounding.

If **open core inductors are used**, special care must be taken as to the location and positioning of this type of inductor. Allowing the inductor flux to intersect sensitive feedback, IC ground path, and C_{OUT} wiring can cause problems.

When using the adjustable version, special care must be taken as to the location of the feedback resistors and the associated wiring. Physically locate both resistors near the IC, and route the wiring away from the inductor, especially an open core type of inductor.

LLP PACKAGE DEVICES

The LM2675 is offered in the 16 lead LLP surface mount package to allow for increased power dissipation compared to the SO-8 and DIP.

The Die Attach Pad (DAP) can and should be connected to PCB Ground plane/island. For CAD and assembly guidelines refer to Application Note AN-1187 at <http://power.national.com>.

PACKAGING INFORMATION

Orderable Device	Status (1)	Package Type	Package Drawing	Pins	Package Qty	Eco Plan (2)	Lead/Ball Finish	MSL Peak Temp (3)	Samples (Requires Login)
LM2675LD-5.0	ACTIVE	WSON	NHN	16	1000	TBD	CU SNPB	Level-1-235C-UNLIM	
LM2675LD-5.0/NOPB	ACTIVE	WSON	NHN	16	1000	Green (RoHS & no Sb/Br)	CU SN	Level-3-260C-168 HR	
LM2675LD-ADJ	ACTIVE	WSON	NHN	16	1000	TBD	CU SNPB	Level-1-235C-UNLIM	
LM2675LD-ADJ/NOPB	ACTIVE	WSON	NHN	16	1000	Green (RoHS & no Sb/Br)	CU SN	Level-3-260C-168 HR	
LM2675LDX-ADJ	ACTIVE	WSON	NHN	16	4500	TBD	CU SNPB	Level-1-235C-UNLIM	
LM2675LDX-ADJ/NOPB	ACTIVE	WSON	NHN	16	4500	Green (RoHS & no Sb/Br)	CU SN	Level-3-260C-168 HR	
LM2675M-12	ACTIVE	SOIC	D	8	95	TBD	CU SNPB	Level-1-235C-UNLIM	
LM2675M-12/NOPB	ACTIVE	SOIC	D	8	95	Green (RoHS & no Sb/Br)	CU SN	Level-1-260C-UNLIM	
LM2675M-3.3/NOPB	ACTIVE	SOIC	D	8	95	Green (RoHS & no Sb/Br)	CU SN	Level-1-260C-UNLIM	
LM2675M-5.0	ACTIVE	SOIC	D	8	95	TBD	CU SNPB	Level-1-235C-UNLIM	
LM2675M-5.0/NOPB	ACTIVE	SOIC	D	8	95	Green (RoHS & no Sb/Br)	CU SN	Level-1-260C-UNLIM	
LM2675M-ADJ	ACTIVE	SOIC	D	8	95	TBD	CU SNPB	Level-1-235C-UNLIM	
LM2675M-ADJ/NOPB	ACTIVE	SOIC	D	8	95	Green (RoHS & no Sb/Br)	CU SN	Level-1-260C-UNLIM	
LM2675MX-12	ACTIVE	SOIC	D	8	2500	TBD	CU SNPB	Level-1-235C-UNLIM	
LM2675MX-12/NOPB	ACTIVE	SOIC	D	8	2500	Green (RoHS & no Sb/Br)	CU SN	Level-1-260C-UNLIM	
LM2675MX-3.3	ACTIVE	SOIC	D	8	2500	TBD	CU SNPB	Level-1-235C-UNLIM	
LM2675MX-3.3/NOPB	ACTIVE	SOIC	D	8	2500	Green (RoHS & no Sb/Br)	CU SN	Level-1-260C-UNLIM	
LM2675MX-5.0/NOPB	ACTIVE	SOIC	D	8	2500	Green (RoHS & no Sb/Br)	CU SN	Level-1-260C-UNLIM	
LM2675MX-ADJ	ACTIVE	SOIC	D	8	2500	TBD	CU SNPB	Level-1-235C-UNLIM	
LM2675MX-ADJ/NOPB	ACTIVE	SOIC	D	8	2500	Green (RoHS & no Sb/Br)	CU SN	Level-1-260C-UNLIM	
LM2675N-12	ACTIVE	PDIP	P	8	40	TBD	Call TI	Level-1-NA-UNLIM	

Orderable Device	Status (1)	Package Type	Package Drawing	Pins	Package Qty	Eco Plan (2)	Lead/Ball Finish	MSL Peak Temp (3)	Samples (Requires Login)
LM2675N-12/NOPB	ACTIVE	PDIP	P	8	40	Green (RoHS & no Sb/Br)	Call TI	Level-1-NA-UNLIM	
LM2675N-3.3	ACTIVE	PDIP	P	8	40	TBD	Call TI	Level-1-NA-UNLIM	
LM2675N-3.3/NOPB	ACTIVE	PDIP	P	8	40	Green (RoHS & no Sb/Br)	Call TI	Level-1-NA-UNLIM	
LM2675N-5.0	ACTIVE	PDIP	P	8	40	TBD	Call TI	Level-1-NA-UNLIM	
LM2675N-5.0/NOPB	ACTIVE	PDIP	P	8	40	Green (RoHS & no Sb/Br)	Call TI	Level-1-NA-UNLIM	
LM2675N-ADJ	ACTIVE	PDIP	P	8	40	TBD	Call TI	Level-1-NA-UNLIM	
LM2675N-ADJ/NOPB	ACTIVE	PDIP	P	8	40	Green (RoHS & no Sb/Br)	Call TI	Level-1-NA-UNLIM	

(1) The marketing status values are defined as follows:

ACTIVE: Product device recommended for new designs.

LIFEBUY: TI has announced that the device will be discontinued, and a lifetime-buy period is in effect.

NRND: Not recommended for new designs. Device is in production to support existing customers, but TI does not recommend using this part in a new design.

PREVIEW: Device has been announced but is not in production. Samples may or may not be available.

OBSELETE: TI has discontinued the production of the device.

(2) Eco Plan - The planned eco-friendly classification: Pb-Free (RoHS), Pb-Free (RoHS Exempt), or Green (RoHS & no Sb/Br) - please check <http://www.ti.com/productcontent> for the latest availability information and additional product content details.

TBD: The Pb-Free/Green conversion plan has not been defined.

Pb-Free (RoHS): TI's terms "Lead-Free" or "Pb-Free" mean semiconductor products that are compatible with the current RoHS requirements for all 6 substances, including the requirement that lead not exceed 0.1% by weight in homogeneous materials. Where designed to be soldered at high temperatures, TI Pb-Free products are suitable for use in specified lead-free processes.

Pb-Free (RoHS Exempt): This component has a RoHS exemption for either 1) lead-based flip-chip solder bumps used between the die and package, or 2) lead-based die adhesive used between the die and leadframe. The component is otherwise considered Pb-Free (RoHS compatible) as defined above.

Green (RoHS & no Sb/Br): TI defines "Green" to mean Pb-Free (RoHS compatible), and free of Bromine (Br) and Antimony (Sb) based flame retardants (Br or Sb do not exceed 0.1% by weight in homogeneous material)

(3) MSL, Peak Temp. -- The Moisture Sensitivity Level rating according to the JEDEC industry standard classifications, and peak solder temperature.

Important Information and Disclaimer: The information provided on this page represents TI's knowledge and belief as of the date that it is provided. TI bases its knowledge and belief on information provided by third parties, and makes no representation or warranty as to the accuracy of such information. Efforts are underway to better integrate information from third parties. TI has taken and continues to take reasonable steps to provide representative and accurate information but may not have conducted destructive testing or chemical analysis on incoming materials and chemicals. TI and TI suppliers consider certain information to be proprietary, and thus CAS numbers and other limited information may not be available for release.

In no event shall TI's liability arising out of such information exceed the total purchase price of the TI part(s) at issue in this document sold by TI to Customer on an annual basis.

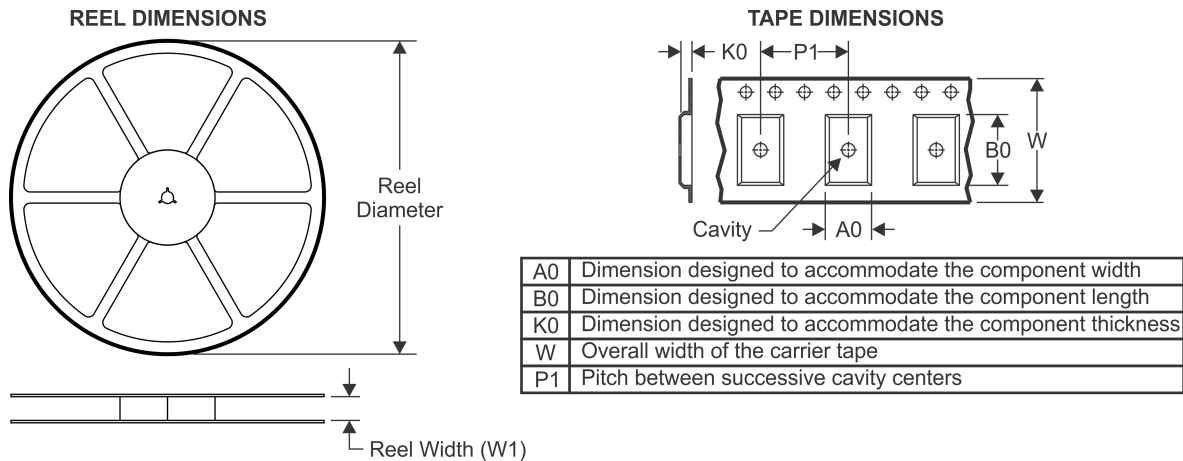
TAPE AND REEL INFORMATION

QUADRANT ASSIGNMENTS FOR PIN 1 ORIENTATION IN TAPE

*All dimensions are nominal

Device	Package Type	Package Drawing	Pins	SPQ	Reel Diameter (mm)	Reel Width W1 (mm)	A0 (mm)	B0 (mm)	K0 (mm)	P1 (mm)	W (mm)	Pin1 Quadrant
LM2675LD-5.0	WSON	NHN	16	1000	178.0	12.4	5.3	5.3	1.3	8.0	12.0	Q1
LM2675LD-5.0/NOPB	WSON	NHN	16	1000	178.0	12.4	5.3	5.3	1.3	8.0	12.0	Q1
LM2675LD-ADJ	WSON	NHN	16	1000	178.0	12.4	5.3	5.3	1.3	8.0	12.0	Q1
LM2675LD-ADJ/NOPB	WSON	NHN	16	1000	178.0	12.4	5.3	5.3	1.3	8.0	12.0	Q1
LM2675LDX-ADJ	WSON	NHN	16	4500	330.0	12.4	5.3	5.3	1.3	8.0	12.0	Q1
LM2675LDX-ADJ/NOPB	WSON	NHN	16	4500	330.0	12.4	5.3	5.3	1.3	8.0	12.0	Q1
LM2675MX-12	SOIC	D	8	2500	330.0	12.4	6.5	5.4	2.0	8.0	12.0	Q1
LM2675MX-12/NOPB	SOIC	D	8	2500	330.0	12.4	6.5	5.4	2.0	8.0	12.0	Q1
LM2675MX-3.3	SOIC	D	8	2500	330.0	12.4	6.5	5.4	2.0	8.0	12.0	Q1
LM2675MX-5.0/NOPB	SOIC	D	8	2500	330.0	12.4	6.5	5.4	2.0	8.0	12.0	Q1
LM2675MX-ADJ	SOIC	D	8	2500	330.0	12.4	6.5	5.4	2.0	8.0	12.0	Q1
LM2675MX-ADJ/NOPB	SOIC	D	8	2500	330.0	12.4	6.5	5.4	2.0	8.0	12.0	Q1

TAPE AND REEL BOX DIMENSIONS

*All dimensions are nominal

Device	Package Type	Package Drawing	Pins	SPQ	Length (mm)	Width (mm)	Height (mm)
LM2675LD-5.0	WSON	NHN	16	1000	203.0	190.0	41.0
LM2675LD-5.0/NOPB	WSON	NHN	16	1000	203.0	190.0	41.0
LM2675LD-ADJ	WSON	NHN	16	1000	203.0	190.0	41.0
LM2675LD-ADJ/NOPB	WSON	NHN	16	1000	203.0	190.0	41.0
LM2675LDX-ADJ	WSON	NHN	16	4500	349.0	337.0	45.0
LM2675LDX-ADJ/NOPB	WSON	NHN	16	4500	358.0	343.0	63.0
LM2675MX-12	SOIC	D	8	2500	349.0	337.0	45.0
LM2675MX-12/NOPB	SOIC	D	8	2500	349.0	337.0	45.0
LM2675MX-3.3	SOIC	D	8	2500	349.0	337.0	45.0
LM2675MX-5.0/NOPB	SOIC	D	8	2500	349.0	337.0	45.0
LM2675MX-ADJ	SOIC	D	8	2500	349.0	337.0	45.0
LM2675MX-ADJ/NOPB	SOIC	D	8	2500	349.0	337.0	45.0

P (R-PDIP-T8)

PLASTIC DUAL-IN-LINE PACKAGE



- NOTES:
- A. All linear dimensions are in inches (millimeters).
 - B. This drawing is subject to change without notice.
 - C. Falls within JEDEC MS-001 variation BA.

D (R-PDSO-G8)

PLASTIC SMALL OUTLINE



NOTES: A. All linear dimensions are in inches (millimeters).
 B. This drawing is subject to change without notice.
 C. Body length does not include mold flash, protrusions, or gate burrs. Mold flash, protrusions, or gate burrs shall not exceed 0.006 (0,15) each side.
 D. Body width does not include interlead flash. Interlead flash shall not exceed 0.017 (0,43) each side.
 E. Reference JEDEC MS-012 variation AA.

IMPORTANT NOTICE

Texas Instruments Incorporated and its subsidiaries (TI) reserve the right to make corrections, enhancements, improvements and other changes to its semiconductor products and services per JESD46, latest issue, and to discontinue any product or service per JESD48, latest issue. Buyers should obtain the latest relevant information before placing orders and should verify that such information is current and complete. All semiconductor products (also referred to herein as "components") are sold subject to TI's terms and conditions of sale supplied at the time of order acknowledgment.

TI warrants performance of its components to the specifications applicable at the time of sale, in accordance with the warranty in TI's terms and conditions of sale of semiconductor products. Testing and other quality control techniques are used to the extent TI deems necessary to support this warranty. Except where mandated by applicable law, testing of all parameters of each component is not necessarily performed.

TI assumes no liability for applications assistance or the design of Buyers' products. Buyers are responsible for their products and applications using TI components. To minimize the risks associated with Buyers' products and applications, Buyers should provide adequate design and operating safeguards.

TI does not warrant or represent that any license, either express or implied, is granted under any patent right, copyright, mask work right, or other intellectual property right relating to any combination, machine, or process in which TI components or services are used. Information published by TI regarding third-party products or services does not constitute a license to use such products or services or a warranty or endorsement thereof. Use of such information may require a license from a third party under the patents or other intellectual property of the third party, or a license from TI under the patents or other intellectual property of TI.

Reproduction of significant portions of TI information in TI data books or data sheets is permissible only if reproduction is without alteration and is accompanied by all associated warranties, conditions, limitations, and notices. TI is not responsible or liable for such altered documentation. Information of third parties may be subject to additional restrictions.

Resale of TI components or services with statements different from or beyond the parameters stated by TI for that component or service voids all express and any implied warranties for the associated TI component or service and is an unfair and deceptive business practice. TI is not responsible or liable for any such statements.

Buyer acknowledges and agrees that it is solely responsible for compliance with all legal, regulatory and safety-related requirements concerning its products, and any use of TI components in its applications, notwithstanding any applications-related information or support that may be provided by TI. Buyer represents and agrees that it has all the necessary expertise to create and implement safeguards which anticipate dangerous consequences of failures, monitor failures and their consequences, lessen the likelihood of failures that might cause harm and take appropriate remedial actions. Buyer will fully indemnify TI and its representatives against any damages arising out of the use of any TI components in safety-critical applications.

In some cases, TI components may be promoted specifically to facilitate safety-related applications. With such components, TI's goal is to help enable customers to design and create their own end-product solutions that meet applicable functional safety standards and requirements. Nonetheless, such components are subject to these terms.

No TI components are authorized for use in FDA Class III (or similar life-critical medical equipment) unless authorized officers of the parties have executed a special agreement specifically governing such use.

Only those TI components which TI has specifically designated as military grade or "enhanced plastic" are designed and intended for use in military/aerospace applications or environments. Buyer acknowledges and agrees that any military or aerospace use of TI components which have **not** been so designated is solely at the Buyer's risk, and that Buyer is solely responsible for compliance with all legal and regulatory requirements in connection with such use.

TI has specifically designated certain components as meeting ISO/TS16949 requirements, mainly for automotive use. In any case of use of non-designated products, TI will not be responsible for any failure to meet ISO/TS16949.

Products

Audio	www.ti.com/audio
Amplifiers	amplifier.ti.com
Data Converters	dataconverter.ti.com
DLP® Products	www.dlp.com
DSP	dsp.ti.com
Clocks and Timers	www.ti.com/clocks
Interface	interface.ti.com
Logic	logic.ti.com
Power Mgmt	power.ti.com
Microcontrollers	microcontroller.ti.com
RFID	www.ti-rfid.com
OMAP Applications Processors	www.ti.com/omap
Wireless Connectivity	www.ti.com/wirelessconnectivity

Applications

Automotive and Transportation	www.ti.com/automotive
Communications and Telecom	www.ti.com/communications
Computers and Peripherals	www.ti.com/computers
Consumer Electronics	www.ti.com/consumer-apps
Energy and Lighting	www.ti.com/energy
Industrial	www.ti.com/industrial
Medical	www.ti.com/medical
Security	www.ti.com/security
Space, Avionics and Defense	www.ti.com/space-avionics-defense
Video and Imaging	www.ti.com/video

TI E2E Community

e2e.ti.com

Mouser Electronics

Authorized Distributor

Click to View Pricing, Inventory, Delivery & Lifecycle Information:

[Texas Instruments:](#)

[LM2675-5.0EVAL](#)