

LM49150 Boomer® Audio Power Amplifier Series Mono Class D Audio Subsystem with Earpiece Driver and Stereo Ground Referenced Headphone Amplifiers

Check for Samples: [LM49150](#), [LM49150TLEVAL](#)

FEATURES

- E²S Class D Amplifier
- Ground Referenced Headphone Outputs — Eliminates Output Coupling Capacitors
- I²C Volume and Mode Control
- Mono Earpiece Amplifier
- Flexible Output for Speaker and Headphone Output
- 20-Bump DSBGA Package
- Soft Enable Function
- “Click and Pop” Suppression Circuitry
- Thermal Shutdown Protection
- Low Supply Current
- Micro-Power Shutdown

APPLICATIONS

- Mobile Phones
- PDAs
- Portable Electronics

DESCRIPTION

The LM49150 is a fully integrated audio subsystem designed for portable handheld applications such as cellular phones. Part of TI's PowerWise™ product family, the LM49150 consumes very low power in the various modes of operation and still providing great audio performance. The LM49150 combines a 1.25W mono E²S (Enhanced Emission Suppression) class D amplifier, 135mW Class AB earpiece amplifier, 42mW/channel stereo ground reference headphone amplifiers, volume control, and mixing circuitry into a single device.

The filterless class D amplifier delivers 1.25W into an 8Ω load with <1% THD+N with a 5V supply. The E²S class D amplifier features a patented, ultra low EMI PWM architecture that significantly reduces RF emissions while preserving audio quality. The 42mW/channel headphone drivers feature TI's ground referenced architecture that creates a ground-referenced output from a single supply, eliminating the need for bulky and expensive DC-blocking capacitors, saving space and minimizing cost.

The LM49150 features a fully differential mono input, and two single-ended stereo inputs. The three inputs can be mixed/multiplexed to either the speaker or headphone amplifiers. Each input channel has an independent, 32-step digital volume control. The headphone output stage features an additional, 8-step gain control, while the speaker output stage has a selectable 6dB or 12dB gain. The mixer, volume control and device mode select are controlled through an I²C compatible serial interface.

The LM49150's superior click and pop suppression eliminates audible transients on power-up/down and during shutdown. The LM49150 is available in a ultra-small 20-bump DSBGA package (2.225mm X 2.644mm).



These devices have limited built-in ESD protection. The leads should be shorted together or the device placed in conductive foam during storage or handling to prevent electrostatic damage to the MOS gates.



Please be aware that an important notice concerning availability, standard warranty, and use in critical applications of Texas Instruments semiconductor products and disclaimers thereto appears at the end of this data sheet.

PowerWise is a trademark of Texas Instruments.

All other trademarks are the property of their respective owners.

Table 1. Key Specifications

			VALUE	UNIT
Output power at $V_{DD} = 5V$:	Speaker:	$R_L = 8\Omega$ BTL, THD+N $\leq 1\%$	1.25	W (typ)
	Headphone:	$R_L = 32\Omega$ SE, THD+N $\leq 1\%$	42	mW (typ)
	Earpiece:	$R_L = 8\Omega$ SE, THD+N $\leq 1\%$	135	mW (typ)
Output power at $V_{DD} = 3.3V$:	Speaker:	$R_L = 8\Omega$ BTL, THD+N $\leq 1\%$	520	mW (typ)
	Headphone:	$R_L = 32\Omega$ BTL, THD+N $\leq 1\%$	42	mW (typ)
	Earpiece:	$R_L = 8\Omega$ SE, THD+N $\leq 1\%$	35	mW (typ)
Output Offset	LS Mode		9	mV (typ)
	HP Mode		1	mV (typ)
	Earpiece		1	mV (typ)
Single Supply Operation (V_{DD})			2.7 to 5.5	V
I^2C Single Supply Operation			1.7 to 5.5	V

Typical Application

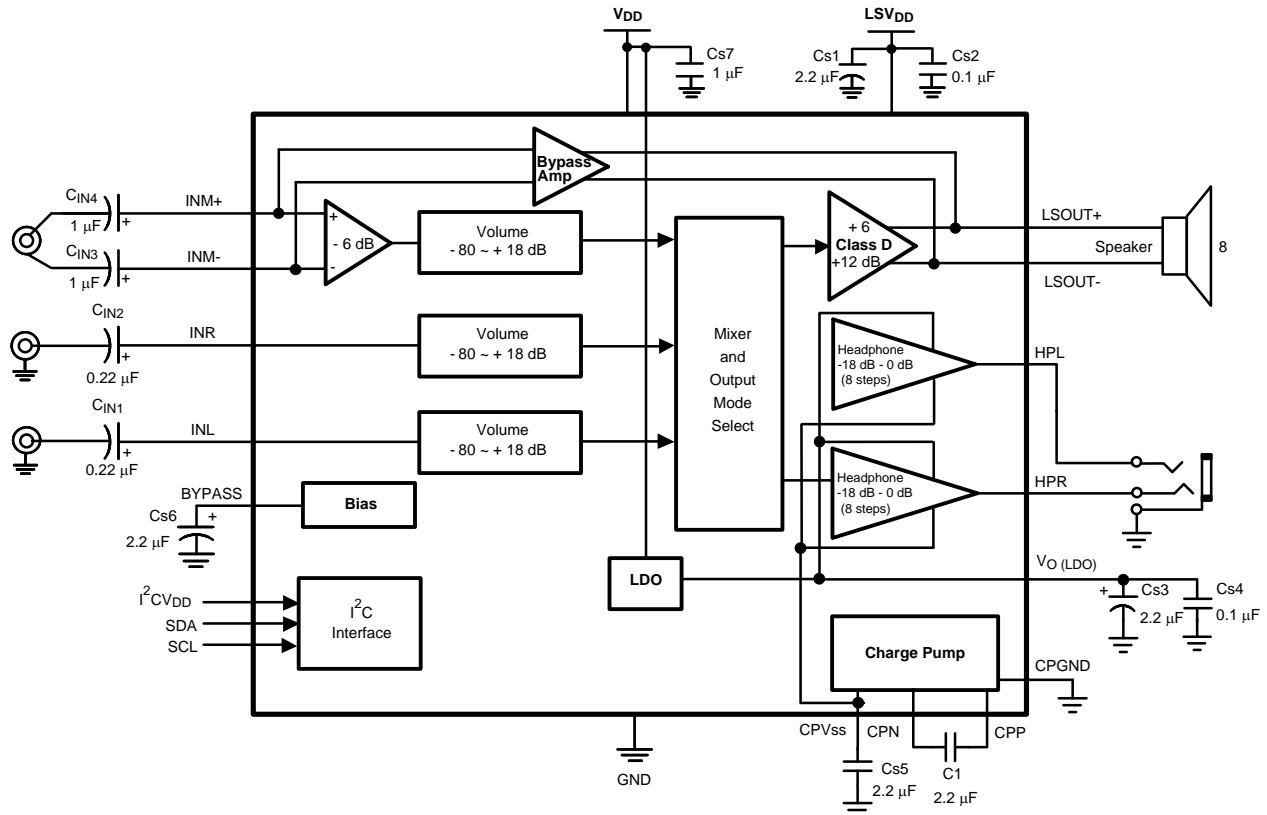
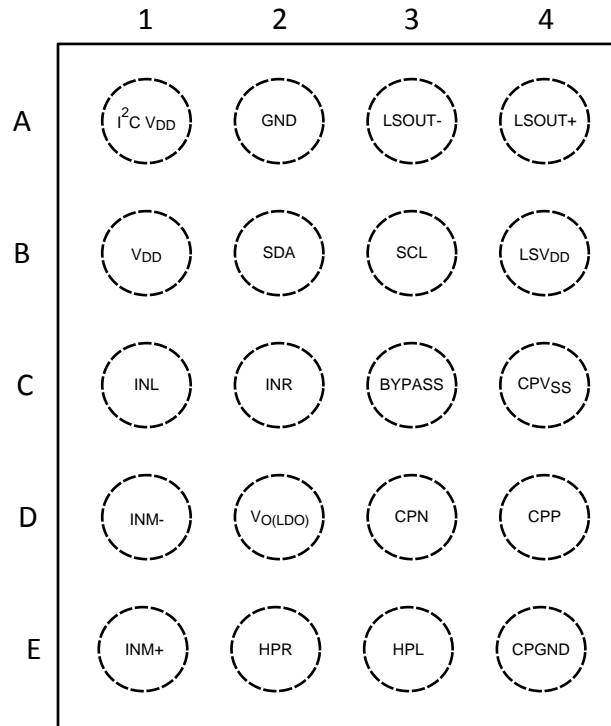

Figure 1. Typical Audio Amplifier Application Circuit-Output Capacitor-less

Connection Diagrams

**Figure 2. 20 Bump DSBGA Package - Top View
(Bump Side Down)
See Package Number YZR0020KGA**

BUMP DESCRIPTIONS

Bump	Name	Description
A1	I ² C V _{DD}	I ² C Power Supply
A2	GND	Ground
A3	LSOUT-	Inverting Loudspeaker Output
A4	LSOUT+	Non-Inverting Loudspeaker Output
B1	V _{DD}	Analog Power Supply
B2	SDA	I ² C Data Input
B3	SCL	I ² C Clock Input
B4	LSV _{DD}	Loudspeaker Power Supply
C1	INL	Left Channel Input
C2	INR	Right Channel Input
C3	BYPASS	Mid-Rail Supply Bypass
C4	CPV _{SS}	Charge Pump Output
D1	INM-	Mono Channel Inverting Input
D2	V _{O(LDO)}	Internal LDO Output
D3	CPN	Charge Pump Flying Capacitor - Negative Terminal
D4	CPP	Charge Pump Flying Capacitor - Positive Terminal
E1	INM+	Mono Channel Non-Inverting Input
E2	HPR	Right Channel Headphone Amplifier Output
E3	HPL	Left Channel Headphone Amplifier Output
E4	CPGND	Charge Pump Ground

Absolute Maximum Ratings⁽¹⁾⁽²⁾⁽³⁾

Supply Voltage ⁽¹⁾		6.0V
Storage Temperature		-65°C to +150°C
Input Voltage		-0.3 to V _{DD} +0.3
Power Dissipation ⁽⁴⁾		Internally Limited
ESD Rating ⁽⁵⁾		2.0kV
ESD Rating ⁽⁶⁾		200V
Junction Temperature		150°C
Soldering Information		See AN-1112 “Micro SMD Wafer Level Chip Scale Package”
Thermal Resistance	θ_{JA} (typ) - YZR0020KGA	46.1°C/W

- (1) “*Absolute Maximum Ratings*” indicate limits beyond which damage to the device may occur, including inoperability and degradation of device reliability and/or performance. Functional operation of the device and/or non-degradation at the *Absolute Maximum Ratings* or other conditions beyond those indicated in the *Recommended Operating Conditions* is not implied. The *Recommended Operating Conditions* indicate conditions at which the device is functional and the device should not be operated beyond such conditions. All voltages are measured with respect to the ground pin, unless otherwise specified.
- (2) The *Electrical Characteristics* tables list ensured specifications under the listed *Recommended Operating Conditions* except as otherwise modified or specified by the *Electrical Characteristics Conditions* and/or Notes. Typical specifications are estimations only and are not ensured.
- (3) If Military/Aerospace specified devices are required, please contact the TI Sales Office/ Distributors for availability and specifications.
- (4) The maximum power dissipation must be derated at elevated temperatures and is dictated by T_{JMAX}, θ_{JA} , and the ambient temperature, T_A. The maximum allowable power dissipation is P_{DMAX} = (T_{JMAX} - T_A) / θ_{JA} or the number given in *Absolute Maximum Ratings*, whichever.
- (5) Human body model, applicable std. JESD22-A114C.
- (6) Machine model, applicable std. JESD22-A115-A.

Operating Ratings

Temperature Range	-40°C to 85°C
Supply Voltage	2.7V ≤ V _{DD} ≤ 5.5V
Supply Voltage (I ² C)	1.7V ≤ I ² CV _{DD} ≤ 5.5V

Electrical Characteristics 3.3V⁽¹⁾

The following specifications apply for V_{DD} = LSV_{DD} = 3.3V, A_V = 0dB, Loudspeaker R_L = 15μH+8Ω+15μH, Earpiece R_L = 8Ω, f = 1kHz, unless otherwise specified. Limits apply for T_A = 25°C. LS = Loudspeaker, HP = Headphone, EP = Earpiece.

Symbol	Parameter	Conditions	LM49150		Units (Limits)
			Typical ⁽²⁾	Limits ⁽³⁾	
I _{DD}	Supply Current	V _{IN} = 0, No Load			
		LS mode 1	3.7	5	mA (max)
		HP mode 8	4.7	6.7	mA (max)
		EP Bypass mode	0.8	1.2	mA (max)
		LS + HP mode 5 and mode 10	7	9.5	mA (max)
		LS mode 1, GAMP_SD = 1	3	4	mA (max)
		HP mode 8, GAMP_SD = 1	4.3	6.1	mA (max)
I _{SD}	Shutdown Current		0.04	1	μA (max)
V _{OS}	Output Offset Voltage	V _{IN} = 0V, LS, R _L = 8Ω LS Gain = 6dB, Stereo mode 10	9	40	mV (max)
		V _{IN} = 0V, HP, R _L = 32Ω Ground Referenced, Stereo mode 10	1	5	mV (max)
		V _{IN} = 0V, EP Bypass only, R _L = 8Ω	0.8	5	mV (max)

- (1) The *Electrical Characteristics* tables list ensured specifications under the listed *Recommended Operating Conditions* except as otherwise modified or specified by the *Electrical Characteristics Conditions* and/or Notes. Typical specifications are estimations only and are not ensured.
- (2) Typical values represent most likely parametric norms at T_A = +25°C, and at the *Recommended Operation Conditions* at the time of product characterization and are not specified.
- (3) Datasheet min/max specification limits are ensured by test or statistical analysis.

Electrical Characteristics 3.3V⁽¹⁾ (continued)

The following specifications apply for $V_{DD} = LSV_{DD} = 3.3V$, $A_V = 0dB$, Loudspeaker $R_L = 15\mu H + 8\Omega + 15\mu H$, Earpiece $R_L = 8\Omega$, $f = 1kHz$, unless otherwise specified. Limits apply for $T_A = 25C$. LS = Loudspeaker, HP = Headphone, EP = Earpiece.

Symbol	Parameter	Conditions	LM49150		Units (Limits)
			Typical ⁽²⁾	Limits ⁽³⁾	
P _O	Output Power	LS mode 1, THD+N = 1%, f = 1kHz LS Gain = 6dB, R _L = 4Ω	845		mW
		LS mode 1, THD+N = 1%, f = 1kHz LS Gain = 6dB, R _L = 8Ω	520	450	mW (min)
		HP mode 8, THD+N = 1%, f = 1kHz HP Attenuation = 0dB, R _L = 16Ω	42		mW
		HP mode 8, THD+N = 1%, f = 1kHz HP Attenuation = 0dB, R _L = 32Ω	43	39	mW (min)
		EP Bypass only, THD+N = 1%, f = 1kHz R _L = 8Ω	35	28	mW (min)
THD+N	Total Harmonic Distortion + Noise	LS mode 1, f = 1kHz P _{OUT} = 250mW; R _L = 8Ω	0.02		%
		HP mode 8, f = 1kHz P _{OUT} = 20mW; R _L = 32Ω	0.009		%
		EP Bypass only, f = 1kHz P _{OUT} = 20mW; R _L = 8Ω	0.15		%
η	Efficiency	LS output	88		%
ε _{OUT}	Output Noise	A-weighted, inputs terminated to AC GND, Output referred			
		EP Bypass	11		μV
		LS; Mode 1	41		μV
		LS; Mode 2	41		μV
		LS; Mode 3	43		μV
		HP; Mode 4	9		μV
		HP; Mode 8	10		μV
		HP; Mode 12	12		μV
PSRR	Power Supply Rejection Ratio	V _{RIPPLE} = 200mV _{PP} ; f = 217Hz, R _L = 8Ω, C _B = 2.2μF, All audio inputs terminated to AC GND, output referred			
		EP Bypass	95		dB
		Loudspeaker Output; LS Gain = 6dB			
		LS; Mode 1	72		dB
		LS; Mode 2	67		dB
		LS; Mode 3	71		dB
		Headphone Output, HP Attenuation = 0dB			
		HP; Mode 4	91		dB
		HP; Mode 8	83		dB
		HP; Mode 12	81		dB
	Volume Control Step Size Error		±0.2		dB
	Digital Volume Control Range	Maximum Attenuation	-92		dB
		Volume Step 2	-46.5	-49 -44	dB (min) dB (max)
		Maximum Gain	18	17 19	dB (min) dB (max)
A _M	Mute Attenuation	HP	98		dB
		LS	98		dB

Electrical Characteristics 3.3V⁽¹⁾ (continued)

The following specifications apply for $V_{DD} = LSV_{DD} = 3.3V$, $A_V = 0dB$, Loudspeaker $R_L = 15\mu H + 8\Omega + 15\mu H$, Earpiece $R_L = 8\Omega$, $f = 1kHz$, unless otherwise specified. Limits apply for $T_A = 25C$. LS = Loudspeaker, HP = Headphone, EP = Earpiece.

Symbol	Parameter	Conditions	LM49150		Units (Limits)
			Typical ⁽²⁾	Limits ⁽³⁾	
Z_{IN}	Mono Channel Input Impedance L_{IN} and R_{IN} Input Impedance	Maximum gain setting	12.9	10 15	k Ω (min) k Ω (max)
		Maximum attenuation setting	111	90 130	k Ω (min) k Ω (max)
	EP Bypass Resistance		62	50 80	k Ω (min) k Ω (max)
CMRR	Common-Mode Rejection Ratio	$f = 217Hz$, $V_{CM} = 1V_{P-P}$, $R_L = 8\Omega$ EP Bypass	55		dB
		$f = 217Hz$, $V_{CM} = 1V_{P-P}$, $R_L = 8\Omega$ LS, Mode 1	55		dB
		$f = 217Hz$, $V_{CM} = 1V_{P-P}$, $R_L = 32\Omega$ HP, Mode 4	61		dB
X_{TALK}	Crosstalk	HP mode 8; $P_O = 12mW$ $R_L = 32\Omega$, $f = 1kHz$	78		dB
T_{ON}	Turn-On Time	$C_B = 2.2\mu F$, HP, Normal Turn-On Mode	27		ms
		$C_B = 2.2\mu F$, HP, Fast Turn-On Mode	15		ms

Electrical Characteristics 5.0V⁽¹⁾⁽²⁾

The following specifications apply for $V_{DD} = LSV_{DD} = 5.0V$, $A_V = 0dB$, Loudspeaker $R_L = 15\mu H + 8\Omega + 15\mu H$, Earpiece $R_L = 8\Omega$, $f = 1kHz$, unless otherwise specified. Limits apply for $T_A = 25C$. LS = Loudspeaker, HP = Headphone, EP = Earpiece.

Symbol	Parameter	Conditions	LM49150		Units (Limits)
			Typical ⁽³⁾	Limits ⁽²⁾	
I_{DD}	Supply Current	$V_{IN} = 0$, No Load			
		LS mode 1	4.5		mA
		HP mode 8	4.9		mA
		EP Bypass Mode	0.9		mA
		LS + HP Mode 5 and Mode 10	7.7		mA
		LS Mode 1, $GAMP_SD = 1$	3.7		mA
		HP Mode 8, $GAMP_SD = 1$	4.4		mA
I_{SD}	Shutdown Current		0.02	1	μA (max)
V_{OS}	Output Offset Voltage	$V_{IN} = 0V$, LS, $R_L = 8\Omega$ LS Gain = 6dB, Stereo Mode 10	9	40	mV (max)
		$V_{IN} = 0V$, HP, $R_L = 32\Omega$ Ground Reference, Stereo Mode 10	1	5	mV (max)
		$V_{IN} = 0V$, EP Bypass only, $R_L = 8\Omega$	1	5	mV (max)

- (1) The *Electrical Characteristics* tables list ensured specifications under the listed *Recommended Operating Conditions* except as otherwise modified or specified by the *Electrical Characteristics Conditions* and/or Notes. Typical specifications are estimations only and are not ensured.
- (2) Datasheet min/max specification limits are ensured by test or statistical analysis.
- (3) Typical values represent most likely parametric norms at $T_A = +25^\circ C$, and at the *Recommended Operation Conditions* at the time of product characterization and are not specified.

Electrical Characteristics 5.0V⁽¹⁾⁽²⁾ (continued)

The following specifications apply for $V_{DD} = LSV_{DD} = 5.0V$, $A_V = 0dB$, Loudspeaker $R_L = 15\mu H + 8\Omega + 15\mu H$, Earpiece $R_L = 8\Omega$, $f = 1kHz$, unless otherwise specified. Limits apply for $T_A = 25C$. LS = Loudspeaker, HP = Headphone, EP = Earpiece.

Symbol	Parameter	Conditions	LM49150		Units (Limits)
			Typical ⁽³⁾	Limits ⁽²⁾	
P _O	Output Power	LS Mode 1, THD+N = 1%, f = 1kHz LS Gain = 6dB, R _L = 4Ω	2.1		W
		LS Mode 1, THD+N = 1%, f = 1kHz LS Gain = 6dB, R _L = 8Ω	1.25		W
		HP Mode 8, THD+N = 1%, f = 1kHz HP Attenuation = 0dB, R _L = 16Ω	42		mW
		HP Mode 8, THD+N = 1%, f = 1kHz HP Attenuation = 0dB, R _L = 32Ω	42		mW
		EP Bypass Only, THD+N = 1% f = 1kHz, R _L = 8Ω	135		mW
THD+N	Total Harmonic Distortion + Noise	LS Mode 1, f = 1kHz P _{OUT} = 600mW; R _L = 8Ω	0.015		%
		HP Mode 8, f = 1kHz P _{OUT} = 20mW; R _L = 32Ω	0.01		%
		EP Bypass only, f = 1kHz, P _{OUT} = 60mW; R _L = 8Ω	0.08		%
η	Efficiency	LS Output	88		%
ε _{OUT}	Output Noise	A-weighted, inputs terminated to AC GND, Output referred			
		EP Bypass	10		μV
		LS; Mode 1	40		μV
		LS; Mode 2	47		μV
		LS; Mode 3	48		μV
		HP; Mode 4	9		μV
		HP; Mode 8	10		μV
		HP; Mode 12	11		μV
PSRR	Power Supply Rejection Ratio	V _{RIPPLE} = 200mV _{PP} ; f = 217Hz, R _L = 8Ω, C _B = 2.2μF, All audio inputs terminated to AC GND; output referred			
		EP Bypass	97		dB
		Loudspeaker Output; LS Gain = 6dB			
		LS; Mode 1	75		dB
		LS; Mode 2	71		dB
		LS; Mode 3	71		dB
		Headphone Output, HP Attenuation = 0dB			
		HP; Mode 4	91		dB
		HP; Mode 8	80		dB
		HP; Mode 12	79		dB
	Volume Control Step Size Error		±0.2		dB
	Digital Volume Control Range	Maximum Attenuation	-92		dB
		Volume Step 2	-46.5	-49 -44	dB (min) dB (max)
		Maximum Gain	18	17 19	dB (min) dB (max)
A _M	Mute Attenuation	HP	98		dB
		LS	98		dB
Z _{IN}	Mono Channel Input Impedance L _{IN} and R _{IN} Input Impedance	Maximum gain setting	12		kΩ
		Maximum attenuation setting	111		kΩ
	EP Bypass Resistance		62	50 80	kΩ (min) kΩ (max)

Electrical Characteristics 5.0V⁽¹⁾⁽²⁾ (continued)

The following specifications apply for $V_{DD} = LSV_{DD} = 5.0V$, $A_V = 0dB$, Loudspeaker $R_L = 15\mu H + 8\Omega + 15\mu H$, Earpiece $R_L = 8\Omega$, $f = 1kHz$, unless otherwise specified. Limits apply for $T_A = 25C$. LS = Loudspeaker, HP = Headphone, EP = Earpiece.

Symbol	Parameter	Conditions	LM49150		Units (Limits)
			Typical ⁽³⁾	Limits ⁽²⁾	
CMRR	Common-Mode Rejection Ratio	$f = 217Hz$, $V_{CM} = 1V_{P-P}$, $R_L = 8\Omega$ EP Bypass	55		dB
		$f = 217Hz$, $V_{CM} = 1V_{P-P}$, $R_L = 8\Omega$ LS, Mode 1	55		dB
		$f = 217Hz$, $V_{CM} = 1V_{P-P}$, $R_L = 32\Omega$ HP, Mode 4	61		dB
X_{TALK}	Crosstalk	HP mode 8; $P_O = 12mW$ $R_L = 32\Omega$, $f = 1kHz$	78		dB
T_{ON}	Turn-On Time	$C_B = 2.2\mu F$, HP, Normal Turn-On Mode	27		ms
		$C_B = 2.2\mu F$, HP, Fast Turn-On Mode	15		ms

I²C micro⁽¹⁾

The following specifications apply for $V_{DD} = 5.0V$ and $3.3V$, $T_A = 25^\circ C$, $2.2V \leq I^2C_{V_{DD}} \leq 5.5V$, unless otherwise specified.

Symbol	Parameter	Conditions	LM49150		Units (Limits)
			Typical ⁽²⁾	Limits ⁽³⁾⁽⁴⁾	
t_1	I ² C Clock Period			2.5	μs (min)
t_2	I ² C Data Setup Time			100	ns (min)
t_3	I ² C Data Stable Time			0	ns (min)
t_4	Start Condition Time			100	ns (min)
t_5	Stop Condition Time			100	ns (min)
t_6	I ² C Data Hold Time			100	ns (min)
V_{IH}	I ² C Input Voltage High			$0.7 \times I^2C_{V_{DD}}$	V (min)
V_{IL}	I ² C Input Voltage Low			$0.3 \times I^2C_{V_{DD}}$	V (max)

- (1) The *Electrical Characteristics* tables list ensured specifications under the listed *Recommended Operating Conditions* except as otherwise modified or specified by the *Electrical Characteristics Conditions* and/or Notes. Typical specifications are estimations only and are not ensured.
- (2) Human body model, applicable std. JESD22-A114C.
- (3) Datasheet min/max specification limits are ensured by test or statistical analysis.
- (4) Machine model, applicable std. JESD22-A115-A.

I²C micro⁽¹⁾

The following specifications apply for $V_{DD} = 5.0V$ and $3.3V$, $T_A = 25^\circ C$, $1.7V \leq I^2C_V_{DD} \leq 2.2V$, unless otherwise specified.

Symbol	Parameter	Conditions	LM49150		Units (Limits)
			Typical ⁽²⁾	Limits ⁽³⁾	
t_1	I ² C Clock Period			2.5	μs (min)
t_2	I ² C Data Setup Time			250	ns (min)
t_3	I ² C Data Stable Time			0	ns (min)
t_4	Start Condition Time			250	ns (min)
t_5	Stop Condition Time			250	ns (min)
t_6	I ² C Data Hold Time			250	ns (min)
V_{IH}	I ² C Input Voltage High			$0.7 \times I^2C_V_{DD}$	V (min)
V_{IL}	I ² C Input Voltage Low			$0.3 \times I^2C_V_{DD}$	V (max)

- (1) The *Electrical Characteristics* tables list ensured specifications under the listed *Recommended Operating Conditions* except as otherwise modified or specified by the *Electrical Characteristics Conditions* and/or Notes. Typical specifications are estimations only and are not ensured.
- (2) Typical values represent most likely parametric norms at $T_A = +25^\circ C$, and at the *Recommended Operation Conditions* at the time of product characterization and are not specified.
- (3) Datasheet min/max specification limits are ensured by test or statistical analysis.

Typical Performance Characteristics

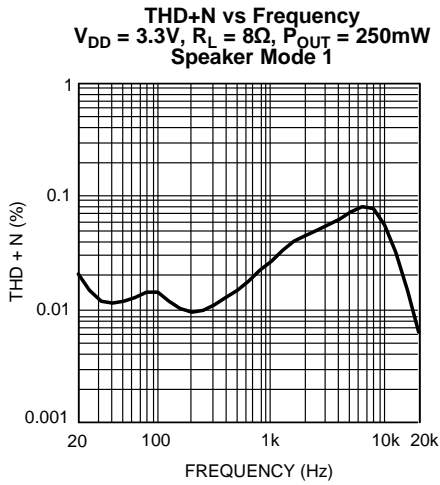

Figure 3.

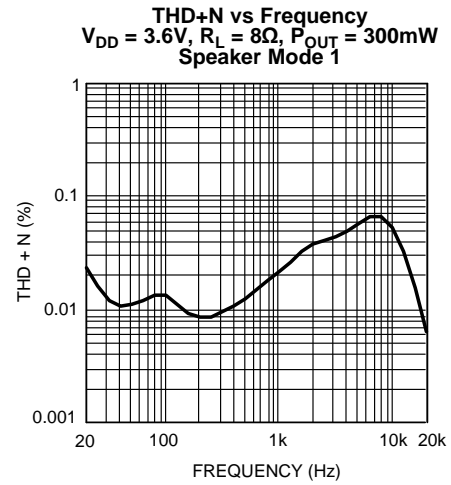

Figure 4.

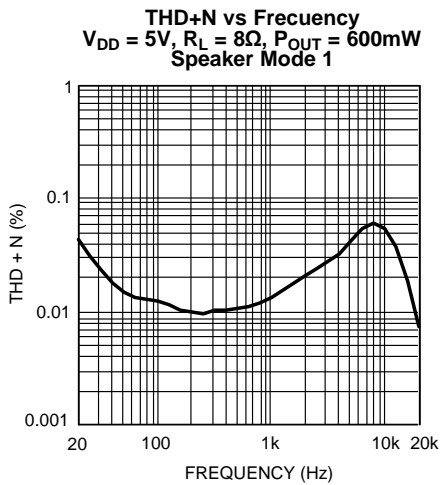

Figure 5.

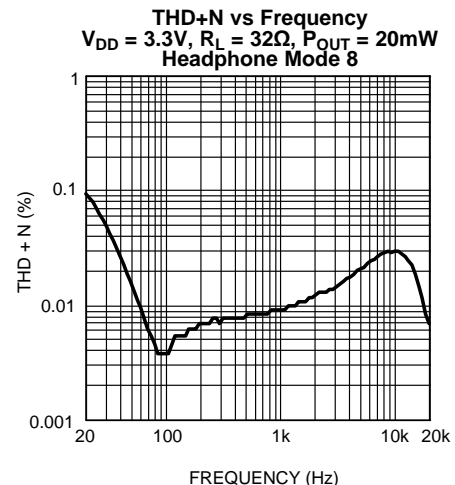

Figure 6.

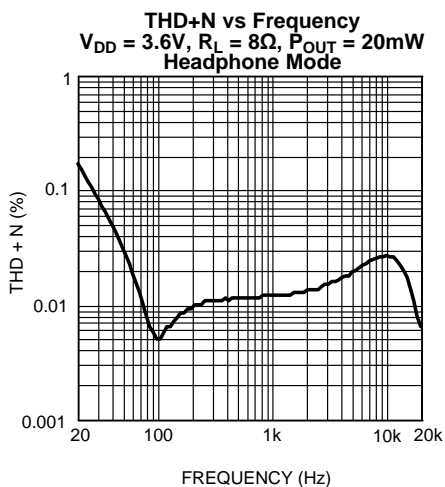

Figure 7.

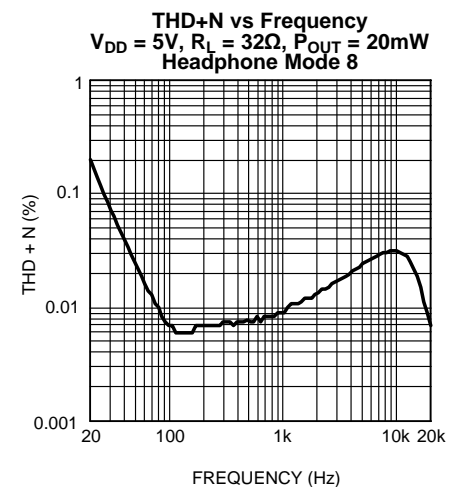

Figure 8.

Typical Performance Characteristics (continued)

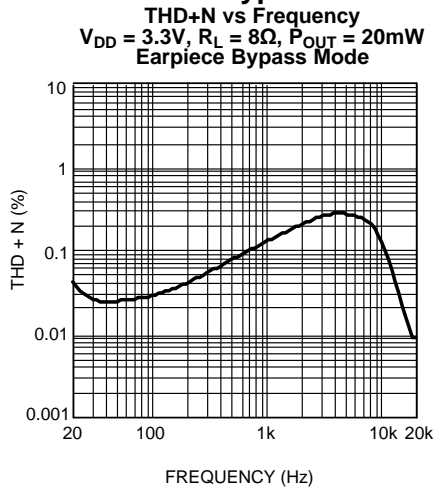

Figure 9.

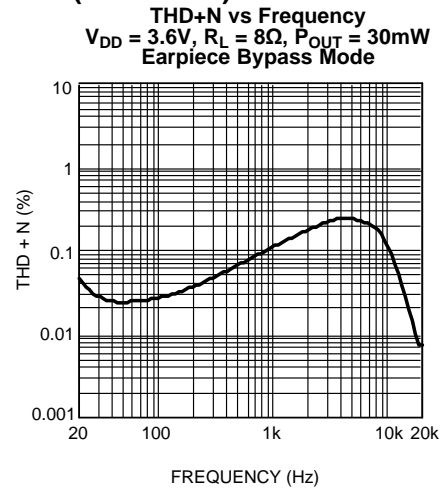

Figure 10.

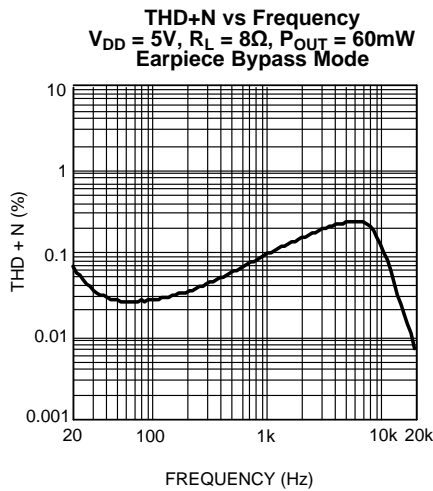

Figure 11.

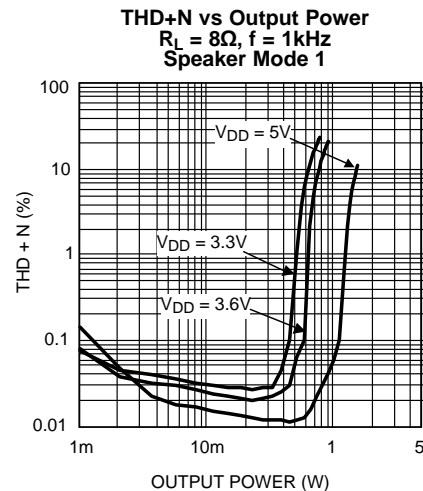

Figure 12.

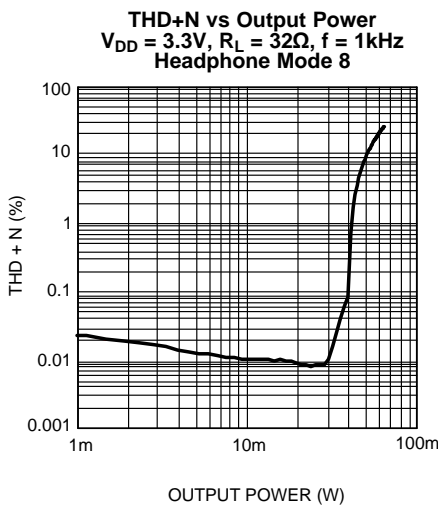

Figure 13.

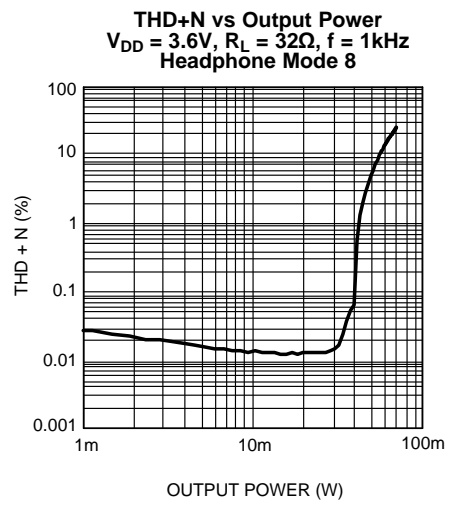

Figure 14.

Typical Performance Characteristics (continued)

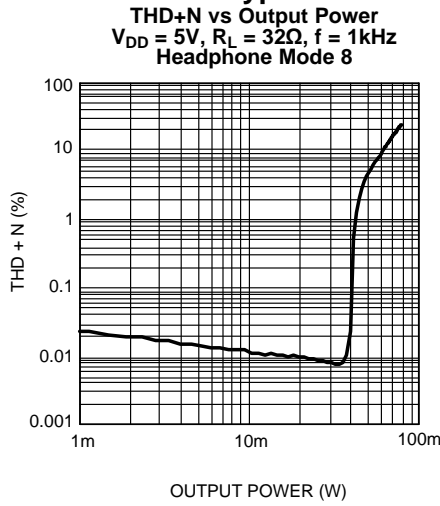

Figure 15.

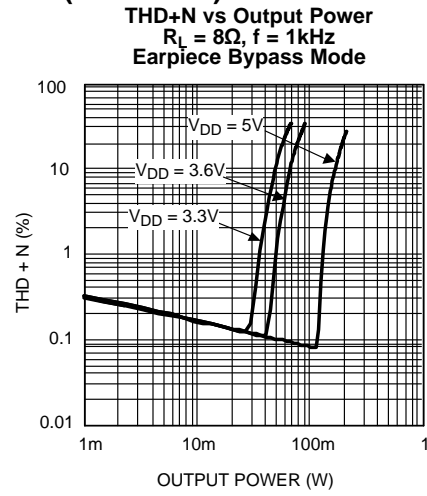

Figure 16.

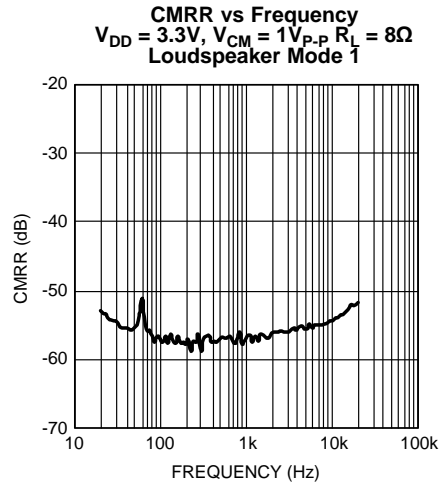

Figure 17.

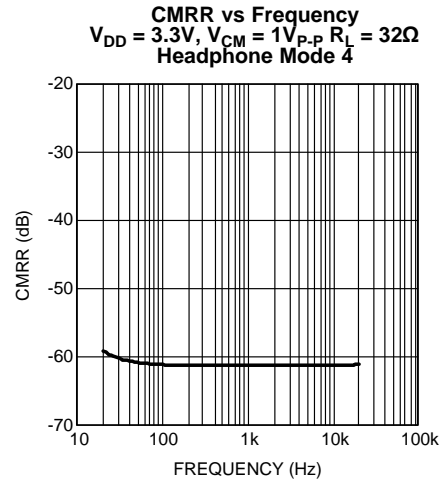

Figure 18.

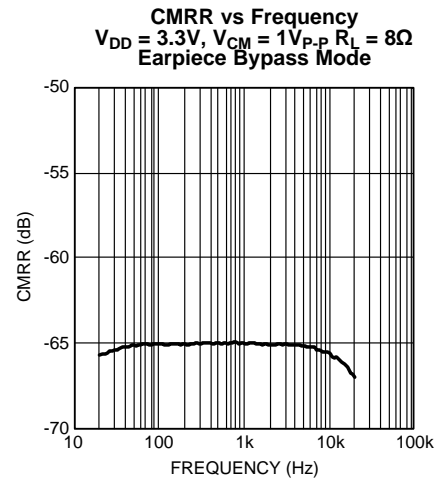

Figure 19.

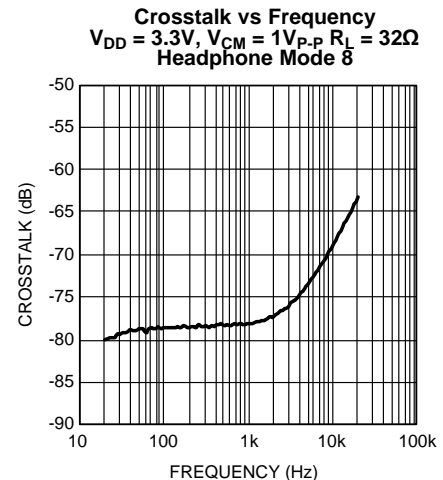

Figure 20.

Typical Performance Characteristics (continued)

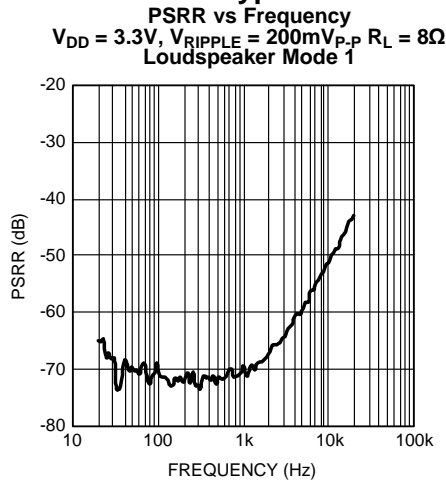

Figure 21.

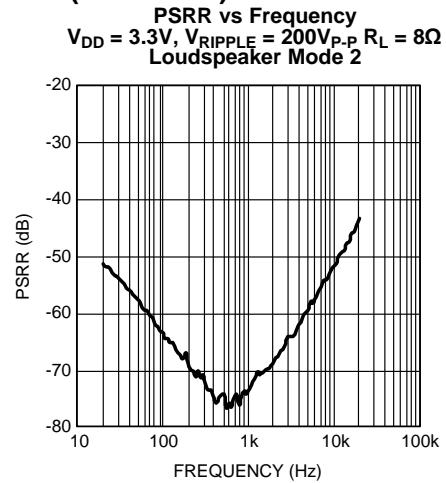

Figure 22.

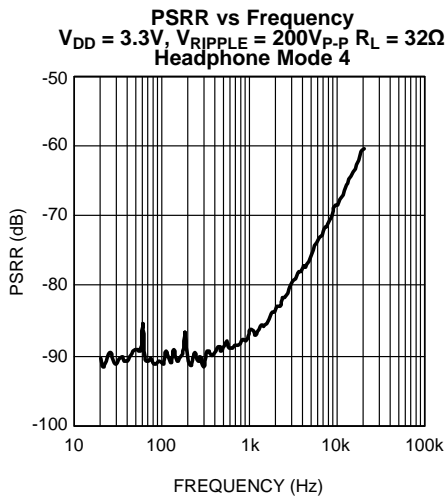

Figure 23.

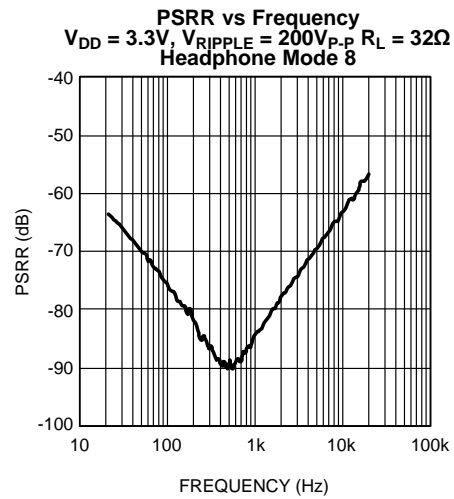

Figure 24.

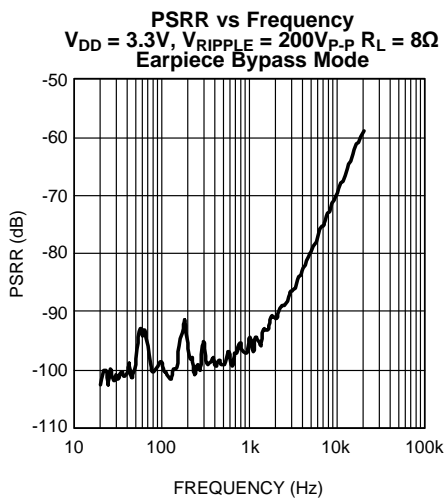

Figure 25.

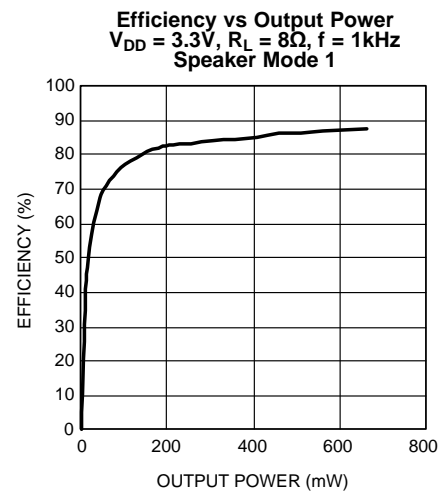

Figure 26.

Typical Performance Characteristics (continued)

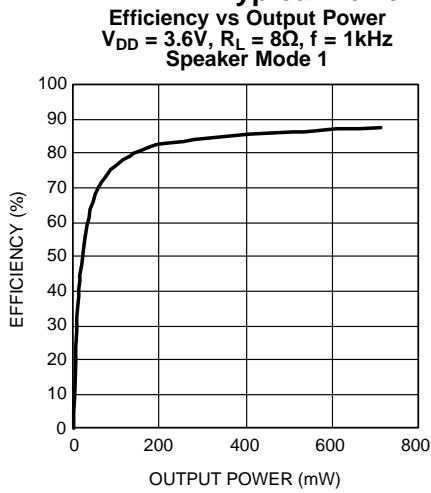

Figure 27.

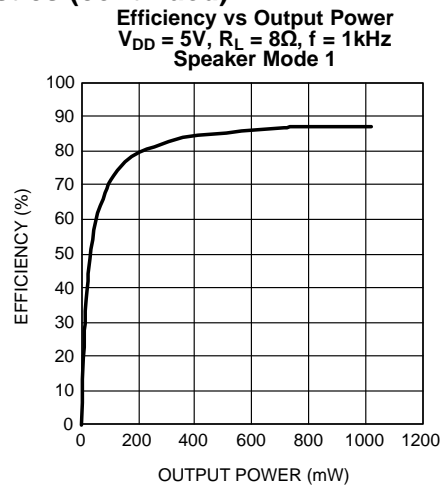

Figure 28.

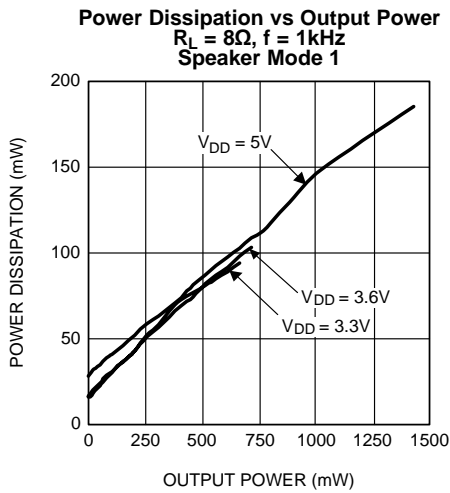

Figure 29.

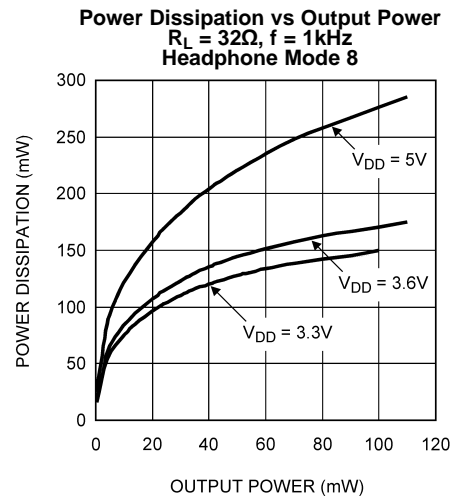

Figure 30.

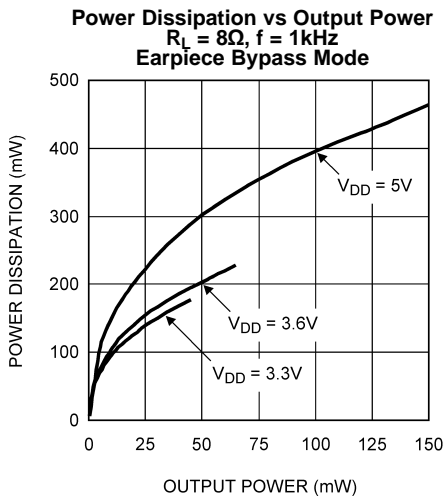

Figure 31.

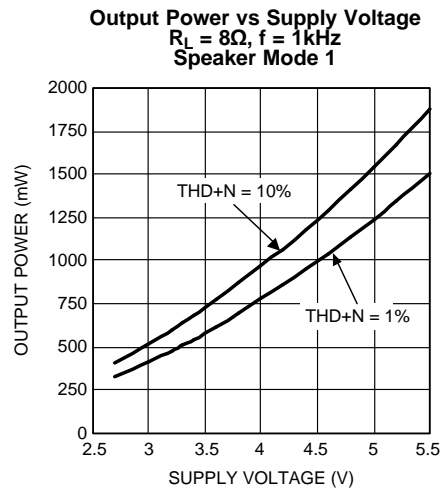

Figure 32.

Typical Performance Characteristics (continued)

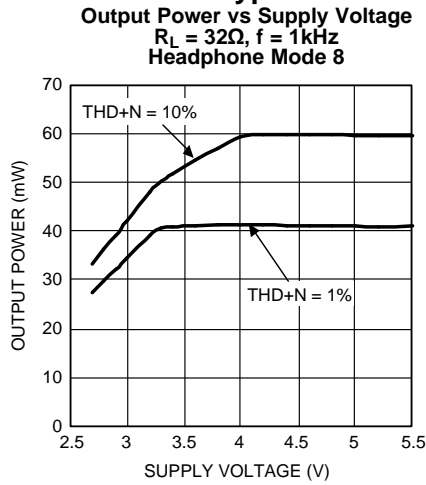

Figure 33.

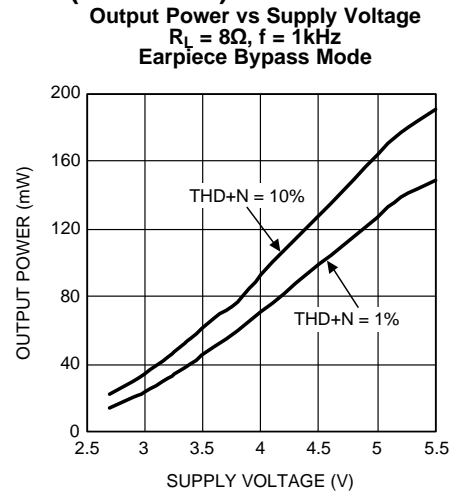

Figure 34.

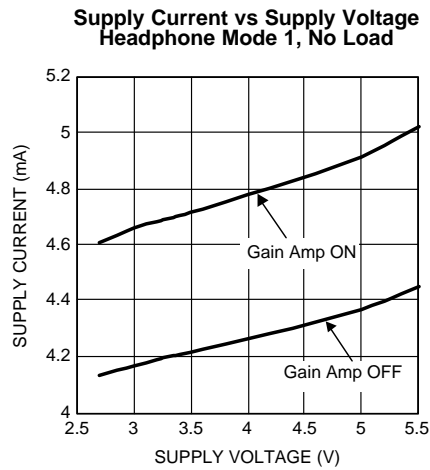

Figure 35.

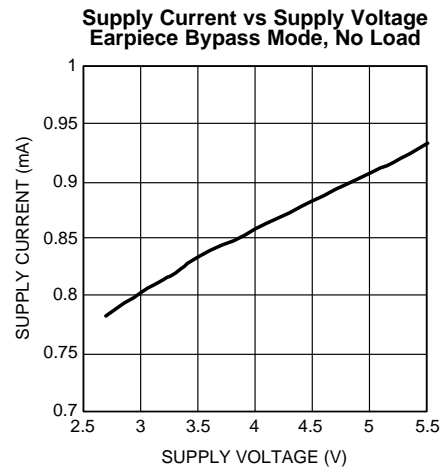

Figure 36.

APPLICATION INFORMATION

I²C COMPATIBLE INTERFACE

The LM49150 is controlled through an I²C compatible serial interface that consists of a serial data line (SDA) and a serial clock (SCL). The clock line is uni-directional. The data line is bi-directional (open drain). The LM49150 and the master can communicate at clock rates up to 400kHz. Figure 37 shows the I²C interface timing diagram. Data on the SDA line must be stable during the HIGH period of SCL. The LM49150 is a transmit/receive slave-only device, reliant upon the master to generate the SCL signal. Each transmission sequence is framed by a START condition and a STOP condition (Figure 38). Each data word, device address and data, transmitted over the bus is 8 bits long and is always followed by an acknowledge pulse (Figure 39). The LM49150 device address is 11111000.

I²C INTERFACE POWER SUPPLY PIN (I²CV_{DD})

The LM49150's I²C interface is powered up through the I²CV_{DD} pin. The LM49150's I²C interface operates at a voltage level set by the I²CV_{DD} pin which can be set independent to that of the main power supply pin V_{DD}. This is ideal whenever logic levels for the I²C interface are dictated by a microcontroller or microprocessor that is operating at a lower supply voltage than the main battery of a portable system.

I²C BUS FORMAT

The I²C bus format is shown in Figure 39. The START signal, the transition of SDA from HIGH to LOW while SCL is HIGH, is generated, alerting all devices on the bus that a device address is being written to the bus.

The 7-bit device address is written to the bus, most significant bit (MSB) first, followed by the R/W bit. R/W = 0 indicates the master is writing to the slave device, R/W = 1 indicates the master wants to read data from the slave device. Set R/W = 0; the LM49150 is a WRITE-ONLY device and will not respond to the R/W = 1. The data is latched in on the rising edge of the clock. Each address bit must be stable while SCL is HIGH. After the last address bit is transmitted, the master device releases SDA, during which time, an acknowledge clock pulse is generated by the slave device. If the LM49150 receives the correct address, the device pulls the SDA line low, generating an acknowledge bit (ACK).

Once the master device registers the ACK bit, the 8-bit register data word is sent. Each data bit should be stable while SCL is HIGH. After the 8-bit register data word is sent, the LM49150 sends another ACK bit. Following the acknowledgement of the register data word, the master issues a STOP bit, allowing SDA to go high while SCL is high.

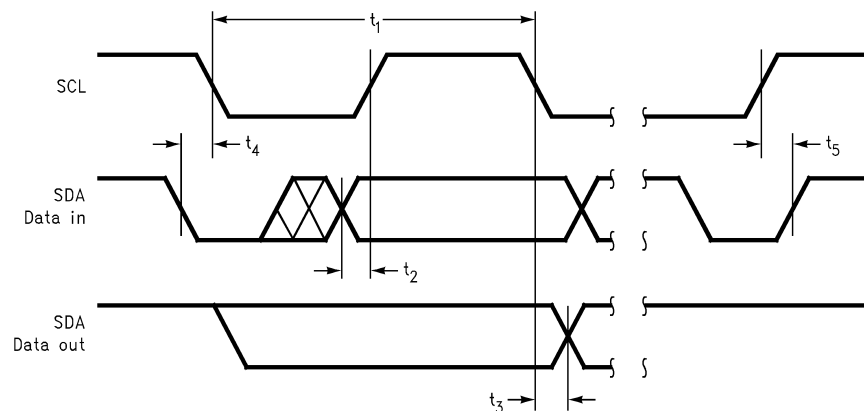

Figure 37. I²C Timing Diagram

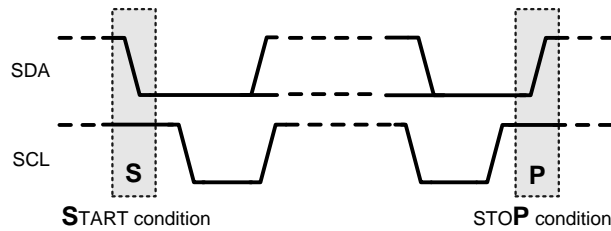

Figure 38. Start and Stop Diagram

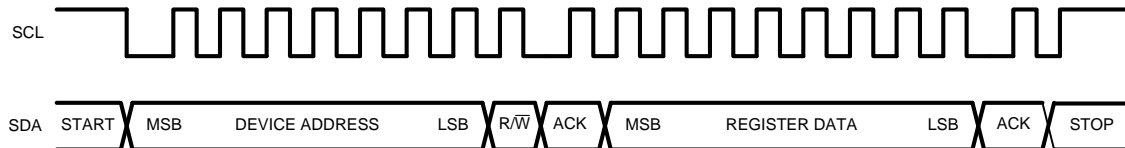

Figure 39. Start and Stop Diagram

Table 2. Chip Address

	B7	B6	B5	B4	B3	B2	B1	B0 (R/ \bar{W})
Chip Address	1	1	1	1	1	0	0	0

Table 3. Control Registers

	B7	B6	B5	B4	B3	B2	B1	B0
Shutdown Control	0	0	Spread Spectrum	GAMP_SD	0	$I^2CV_{DD_SD}$	Turn_On_Time	PWR_On
Output Mode Control	0	1	EP Bypass	HPR_SD	MC3 (HP L&R)	MC2 (HP Mono)	MC1 (LS L&R)	MC0 (LS Mono)
Output Gain Control	1	0	0	INPUT_MUTE	LS_GAIN	HP_GAIN2	HP_GAIN1	HP_GAIN0
Mono Input Volume Control	1	0	1	MG4	MG3	MG2	MG1	MG0
Left Input Volume Control	1	1	0	LG4	LG3	LG2	LG1	LG0
Right Input Volume Control	1	1	1	RG4	RG3	RG2	RG1	RG0

Table 4. Shutdown Control Register

Bit	Name	Value	Description
B5	Spread Spectrum	0	Spread Spectrum Disabled
		1	Spread Spectrum Enabled
B4	GAMP_SD	0	Normal Operation
		1	Disables the gain amplifiers that are not in use, to minimize I_{DD} . Recommended for Output Modes 1, 2, 4, 5, 8, 10
B3		0	
B2	$I^2CV_{DD_SD}$	0	I^2CV_{DD} acts as an active low RESET input. If I^2CV_{DD} drops below 1.1V, the device resets and the I^2C registers are restored to their default state.
		1	Normal Operation. I^2CV_{DD} voltage does not reset the device.
B1	Turn_On_Time	0	Normal Turn-On Time (27ms)
		1	Fast Turn-On Time (15ms)
B0	PWR_On	0	Device Disabled
		1	Device Enabled

Table 5. Output Mode Control Register

Bit	Name	Value	Description
B5	EP Bypass	0	Normal Output Mode Operation
		1	Speaker and Headphone amplifier goes into shutdown mode and enables Receiver Bypass path
B4	HPR_SD	0	Normal Operation
		1	Disables Right Headphone Output

Table 6. Output Mode Selection (See⁽¹⁾)

Output Mode Number	MC3	MC2	MC1	MC0	LS Output	HP R Output	HP L Output
0	0	0	0	0	SD	SD	SD
1	0	0	0	1	$G_P \times M$	SD	SD
2	0	0	1	0	$2 \times (G_L \times L + G_R \times R)$	SD	SD
3	0	0	1	1	$2 \times (G_L \times L + G_R \times R) + G_P \times M$	SD	SD
4	0	1	0	0	SD	$G_P \times M/2$	$G_P \times M/2$
5	0	1	0	1	$G_P \times M$	$G_P \times M/2$	$G_P \times M/2$
6	0	1	1	0	$2 \times (G_L \times L + G_R \times R)$	$G_P \times M/2$	$G_P \times M/2$
7	0	1	1	1	$2 \times (G_L \times L + G_R \times R) + G_P \times M$	$G_P \times M/2$	$G_P \times M/2$
8	1	0	0	0	SD	$G_R \times R$	$G_L \times L$
9	1	0	0	1	$G_P \times M$	$G_R \times R$	$G_L \times L$
10	1	0	1	0	$2 \times (G_L \times L + G_R \times R)$	$G_R \times R$	$G_L \times L$
11	1	0	1	1	$2 \times (G_L \times L + G_R \times R) + G_P \times M$	$G_R \times R$	$G_L \times L$
12	1	1	0	0	SD	$G_R \times R + G_P \times M/2$	$G_L \times L + G_P \times M/2$
13	1	1	0	1	$G_P \times M$	$G_R \times R + G_P \times M/2$	$G_L \times L + G_P \times M/2$
14	1	1	1	0	$2 \times (G_L \times L + G_R \times R)$	$G_R \times R + G_P \times M/2$	$G_L \times L + G_P \times M/2$
15	1	1	1	1	$2 \times (G_L \times L + G_R \times R) + G_P \times M$	$G_R \times R + G_P \times M/2$	$G_L \times L + G_P \times M/2$

- (1) MC3: HP Select L and R In
 MC2: HP Select Mono In
 MC1: Loud Speaker Select L and R In
 MC0: Loud Speaker Select Mono In
 M : Phone In (Mono)
 R: Right In
 L: Left In
 SD: Shutdown
 G_P : Phone In (Mono) Volume Control Gain
 G_R : Right Stereo Volume Control Gain
 G_L : Left Stereo Volume Control Gain

MC1	MC0	LSOUT
0	0	SD
0	1	M
1	0	L+R
1	1	M+L+R

MC3	MC2	HPR Output	HPL Output
0	0	SD	SD
0	1	M	M
1	0	L	R
1	1	M+L	M+R

Table 7. Output Gain Control (Loudspeaker)

Bit	Value	Gain (dB)
LS_GAIN	0	+6
	1	+12

Table 8. Headphone Output Gain Setting

HP_Gain2	HP_Gain1	HP_Gain0	Gain (dB)
0	0	0	0
0	0	1	-1.2
0	1	0	-2.5
0	1	1	-4.0
1	0	0	-6.0
1	0	1	-8.5
1	1	0	-12
1	1	1	-18

Table 9. Volume Control Table

Volume Step	xG4 ⁽¹⁾	xG3	xG2	xG1	xG0	Gain (dB) ⁽²⁾
1	0	0	0	0	0	-80.00
2	0	0	0	0	1	-46.50
3	0	0	0	1	0	-40.50
4	0	0	0	1	1	-34.50
5	0	0	1	0	0	-30.00
6	0	0	1	0	1	-27.00
7	0	0	1	1	0	-24.00
8	0	0	1	1	1	-21.00
9	0	1	0	0	0	-18.00
10	0	1	0	0	1	-15.00
11	0	1	0	1	0	-13.50
12	0	1	0	1	1	-12.00
13	0	1	1	0	0	-10.50
14	0	1	1	0	1	-9.00
15	0	1	1	1	0	-7.50
16	0	1	1	1	1	-6.00
17	1	0	0	0	0	-4.50
18	1	0	0	0	1	-3.00
19	1	0	0	1	0	-1.50
20	1	0	0	1	1	0.00
21	1	0	1	0	0	1.50
22	1	0	1	0	1	3.00
23	1	0	1	1	0	4.50
24	1	0	1	1	1	6.00
25	1	1	0	0	0	7.50
26	1	1	0	0	1	9.00
27	1	1	0	1	0	10.50
28	1	1	0	1	1	12.00
29	1	1	1	0	0	13.50

(1) x = M, L and R

(2) Gain / Attenuation is from input to output

Table 9. Volume Control Table (continued)

Volume Step	xG4 ⁽¹⁾	xG3	xG2	xG1	xG0	Gain (dB) ⁽²⁾
30	1	1	1	0	1	15.00
31	1	1	1	1	0	16.50
32	1	1	1	1	1	18.00

SHUTDOWN FUNCTION

The LM49150 features the following shutdown controls.

Bit B4 (GAMP_SD) of the SHUTDOWN CONTROL register controls the gain amplifiers. When GAMP_SD = 1, it disables the gain amplifiers that are not in use. For example, in Modes 1, 4 and 5, the Mono inputs are in use, so the Left and Right input gain amplifiers are disabled, causing the I_{DD} to be minimized.

Bit B0 (PWR_On) of the SHUTDOWN CONTROL register is the global shutdown control for the entire device. Set PWR_On = 0 for normal operation. PWR_On = 1 overrides any other shutdown control bit.

OUTPUT MODE CONTROL

In the LM49150 OUTPUT MODE CONTROL register (Table 5), Bit B5 (EP Bypass) controls the operation of the Earpiece Bypass path. If EP Bypass = 0, it would act under normal output mode operation set by bits B3, B2, B1, and B0. If EP Bypass = 1, it overrides the B3, B2, B1, and B0 Bits and enables the Receiver Bypass path, a class AB amplifier, to the speaker output.

Bit B4 (HPR_SD) of the OUPUT MODE CONTROL register controls the right headphone shutdown. If HPR_SD = 1, the right headphone output is disabled.

DIFFERENTIAL AMPLIFIER EXPLANATION

The LM49150 features a differential input stage, which offers improved noise rejection compared to a single-ended input amplifier. Because a differential input amplifier amplifies the difference between the two input signals, any component common to both signals is cancelled. An additional benefit of the differential input structure is the possible elimination of the DC input blocking capacitors. Since the DC component is common to both inputs, and thus cancelled by the amplifier, the LM49150 can be used without input coupling capacitors when configured with a differential input signal.

SINGLE-ENDED INPUT CONFIGURATION

The left and right stereo inputs of the LM49150 are configured for single-ended sources (see Figure 1).

INPUT CAPACITOR SELECTION

Input capacitors may be required for some applications, or when the audio source is single-ended. Input capacitors block the DC component of the audio signal, eliminating any conflict between the DC component of the audio source and the bias voltage of the LM49150. The input capacitors create a high-pass filter with the input resistors R_{IN}. The -3dB point of the high-pass filter is found using Equation 1 below.

$$f = 1 / 2\pi R_{IN} C_{IN} \quad (\text{Hz})$$

Where

- value of R_{IN} is given in the [Electrical Characteristics Table](#). (1)

High-pass filtering the audio signal helps protect the speakers. When the LM49150 is using a single-ended source, power supply noise on the ground is seen as an input signal. Setting the high-pass filter point above the power supply noise frequencies, 217Hz in a GSM phone, for example, filters out the noise such that it is not amplified and heard on the output. Capacitors with a tolerance of 10% or better are recommended for impedance matching and improved CMRR and PSRR.

INPUT MIXER/MULTIPLEXER

The LM49150 includes a comprehensive mixer multiplexer controlled through the I²C interface. The mixer/multiplexer allows any input combination to appear on any output of LM49150. Multiple input paths can be selected simultaneously. Under these conditions, the selected inputs are mixed together and output on the selected channel. [Table 6](#) shows how the input signals are mixed together for each possible input selection.

CLASS D AMPLIFIER

The LM49150 features a high-efficiency, filterless, class D amplifier, which features a filterless modulation scheme. When there is no input signal applied, the output switches between V_{DD} and GND at a 50% duty cycle. Since the outputs of the LM49150 class D amplifier are differential and in phase, the result is zero net voltage across the speaker and no load current during the ideal state, thus conserving power. The switching frequency of each output is 300kHz.

When an input signal is applied, the duty cycle (pulse width) changes. For increasing output voltages, the duty cycle of one output increases while the duty cycle of the output decreases. For decreasing output voltages, the converse occurs. The difference between the two pulse widths yields the differential output voltage across the load.

SPREAD SPECTRUM

The LM49150 features a filterless spread spectrum modulation scheme. The switching frequency varies by +/- 30% about a 300kHz center frequency, reducing the wideband spectral content, reducing EMI emissions radiated by the speaker and associated cables and traces. When a fixed frequency class D exhibits large amounts of spectral energy at multiples of switching frequency, the spread spectrum architecture of the LM49150 spreads that energy over a larger bandwidth. The cycle-to-cycle variation of the switching period does not affect the audio reproduction, efficiency, or PSRR. To enable spread spectrum, set the spread spectrum bit, B5 = 1 of the SHUTDOWN CONTROL register (see [Table 4](#)).

ENHANCED EMISSIONS SUPPRESSION (E²S)

The LM49150 features TI's patented E²S system that reduces EMI, while maintaining high quality audio reproduction and efficiency. The LM49150 features Edge Rate Control (ERC) that greatly reduces the high frequency components of the output square waves by controlling the output rise and fall times, slowing the transitions to reduce RF emissions, while optimizing THD+N and efficiency performance.

LDO GENERAL INFORMATION

The LM49150 has different supplies for each portion of the device, allowing for the optimum combination of headroom, power dissipation and noise immunity. The speaker amplifiers are powered from LSV_{DD}. The ground reference headphone amplifiers are powered from the internal LDO. The separate power supplies allow the loudspeaker amplifier to operate from a higher voltage for maximum headroom, while the headphone amplifiers operate from a lower voltage, improving power dissipation.

GROUND REFERENCED HEADPHONE AMPLIFIER

The LM49150 features a low noise inverting charge pump that generates an internal negative supply voltage. This allows the headphone outputs to be biased about GND instead of a nominal DC voltage, like traditional headphone amplifiers. Because there is no DC component, the large DC blocking capacitors (typically 220μF) are not necessary. The coupling capacitors are replaced by two small ceramic charge pump capacitors, saving board space and cost. Eliminating the output coupling capacitors also improves low frequency response. In traditional headphone amplifiers, the headphone impedance and the output capacitor from a high-pass filter that not only blocks the DC component of the output, but also attenuates low frequencies, impacting the bass response. Because the LM49150 does not require the output coupling capacitors, the low frequency response of the device is not degraded by external components. In addition to eliminating the output coupling capacitors, the ground referenced output nearly doubles the available dynamic range of the LM49250 headphone amplifiers when compared to a traditional headphone amplifier operating from the same supply voltage.

CHARGE PUMP CAPACITOR SELECTION

Use low ESR ceramic capacitors (less than 100mΩ) for optimum performance.

CHARGE PUMP FLYING CAPACITOR (C1)

The flying capacitor (C1), see [Figure 1](#), affects the load regulation and output impedance of the charge pump. A C1 value that is too low results in a loss of current drive, leading to a loss of amplifier headroom. A higher valued C1 improves load regulation and lowers charge pump output impedance to an extent. Above 2.2 μ F, the $R_{DS(ON)}$ of the charge pump switches and the ESR of C1 and Cs5 dominate the output impedance. A lower value capacitor can be used in systems with low maximum output power requirements.

CHARGE PUMP HOLD CAPACITOR (Cs5)

The value and ESR of the hold capacitor (Cs5) directly affects the ripple on CPV_{SS} . Increasing the value of Cs5 reduces output ripple. Decreasing the ESR of Cs5 reduces both output ripple and charge pump output impedance. A lower value capacitor can be used in systems with low maximum output power requirements.

LM49150 Demoboard Bill Of Materials

Table 10. Bill Of Materials

Location	Qty	Description	Part Number	Manufacturer
CIN2, CIN1	2	0.22 μ F, 1206, 10V, X7R Ceramic Capacitor	GRM319R71C224KA01D	Murata
CS4, CS2	2	0.1 μ F, 0805, 10V, X7R Ceramic Capacitor	GRM219R71C104KA01D	Murata
CS7	1	1.0 μ F, 0805, 10V, X7R Ceramic Capacitor	GRM21BR71A105KA01L	Murata
CIN3, CIN4	2	1.0 μ F 1206, 10V, X7R Ceramic Capacitor	GRM319R71C105KAA3D	Murata
CS5, C1	2	2.2 μ F, 0603, 10V, X7R, Ceramic Capacitor	GRM188R71A225KE15D	Murata
CS1, CS3, CS6	3	2.2 μ F, Size A, Tantalum Capactor	293D225X9010A2TE3	Vishay
U2	1	LM49150, 16 bump DSBGA	LM49510	TI
R1, R2	2	5K ohm 1/10W 0.05% 0603 SMD	CRCW06035R1KJNEA	Vishay
J11, J12, J13, J14	4	3-Header		
J1, J2, J3, J7, J8, J9, J10	7	2-Header		
J6	1	Header_3M 8516-4500PL		
U1	1	Headphone Jack		

Layout Guidelines

Minimize trace impedance of the power, ground and all output traces for optimum performance. Voltage loss due to trace resistance between the LM49150 and the load results in decreased output power and efficiency. Trace resistance between the power supply and the GND of the LM49150 has the same effect as a poorly regulated supply, increased ripple and reduced peak output power. Use wide traces, for power-supply inputs and amplifier outputs to minimize losses due to trace resistance, as well as providing heat dissipation from the device. Proper grounding improves audio performance, minimizes crosstalk between channels and prevents switching noise from interfering with audio signal. Use of power and ground planes is recommended.

The following recommendations should be considered when laying out the different grounds of the LM49150. Refer to the Demo Board Schematic for the corresponding component designators. Bypass capacitors for AV_{DD} (CS7), LSV_{DD} (CS1, CS2), $V_{O(LDO)}$ (CS3, CS4) should be grounded to the GND pin via a ground plane. Bypass capacitor for CPV_{SS} (CS5) should be grounded via a wide trace or a ground plane to the CPGND pin. The headphone grounds should be connected to the GND via a separate trace also. This will help prevent noise from the charge pump from feeding into the power supplies and the output.

Place all digital components and digital signal traces as far as possible from analog components and traces. Do not run digital and analog traces in parallel on the same PCB layer.

Demo Board Schematic

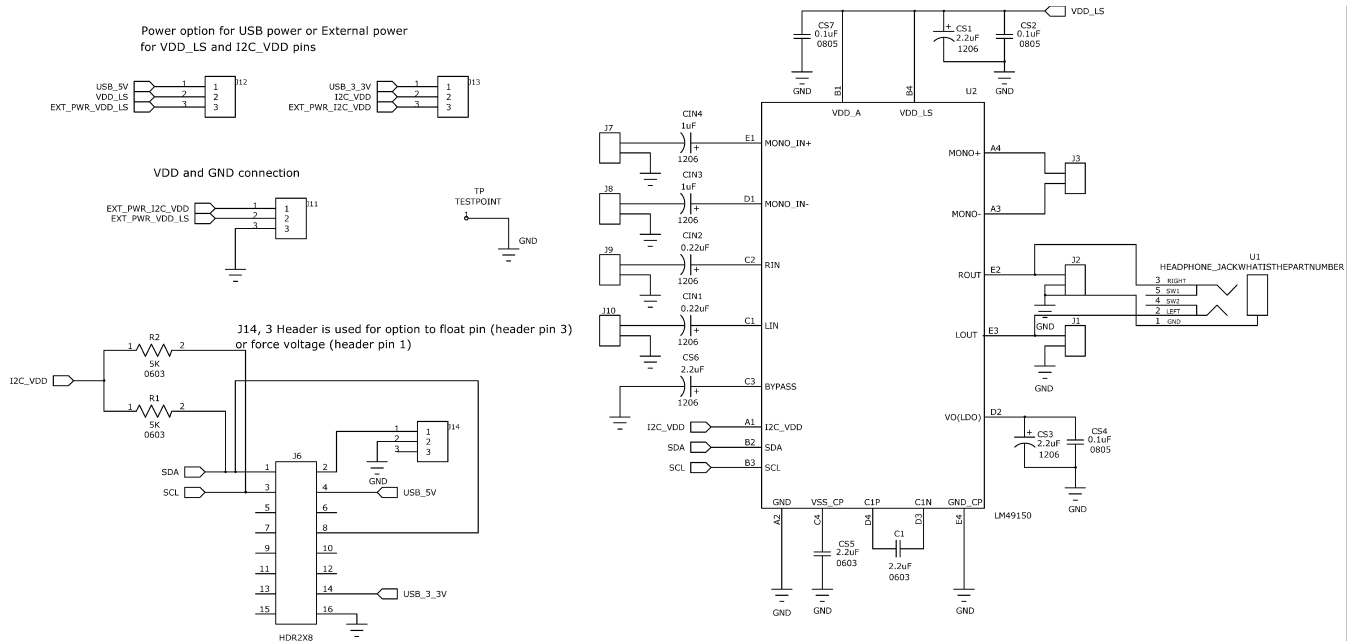

Figure 40. LM49150 Demo Board Schematic

PC Board Layout

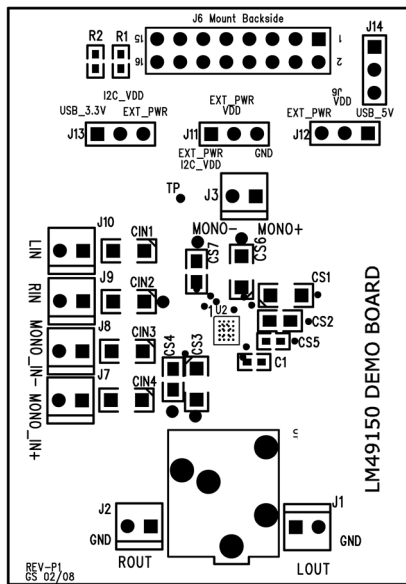

Figure 41. Top Silkscreen Layer

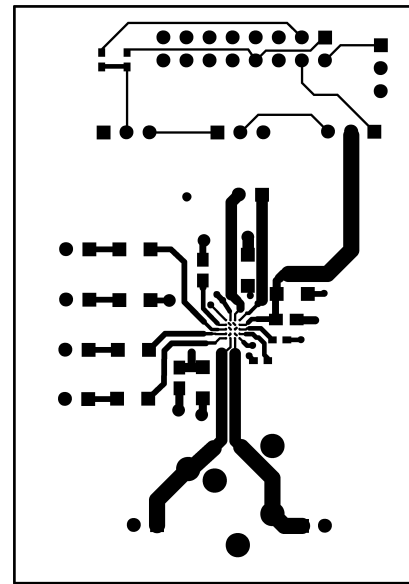

Figure 42. Top Layer

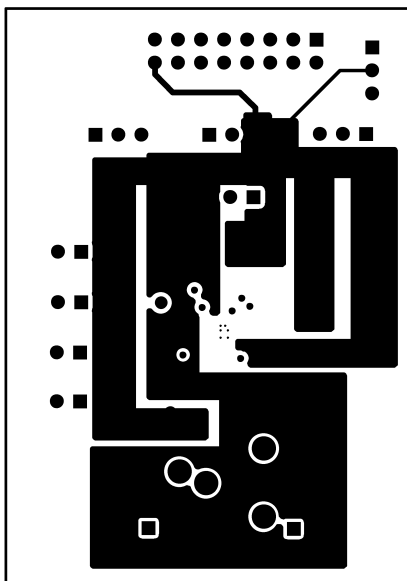

Figure 43. Layer 2

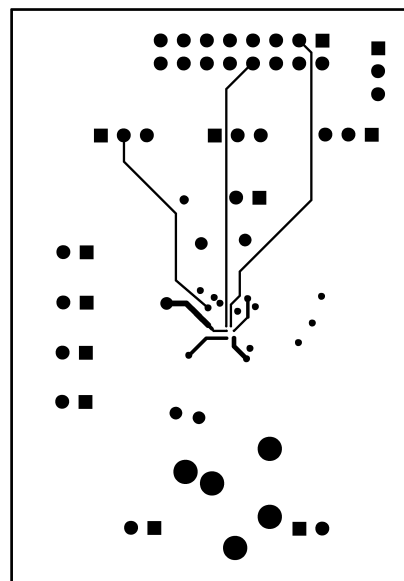

Figure 44. Layer 3

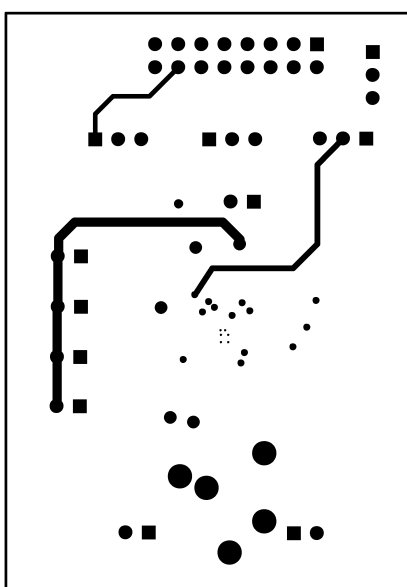

Figure 45. Bottom Layer

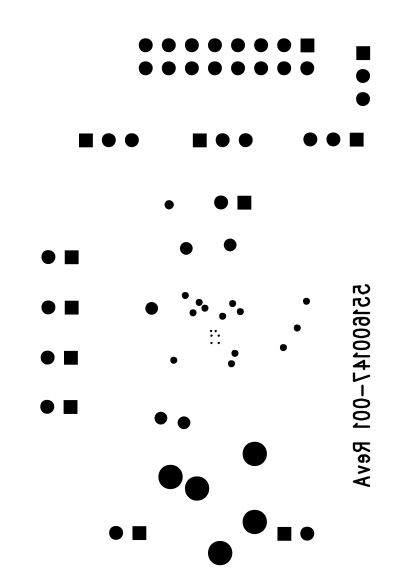

Figure 46. Bottom Silkscreen

REVISION HISTORY

Rev	Date	Description
1.0	08/27/08	Initial release.
1.01	09/09/08	Edited Table 6.
1.02	03/04/09	Added the Layout Guidelines section.

PACKAGING INFORMATION

Orderable Device	Status (1)	Package Type	Package Drawing	Pins	Package Qty	Eco Plan (2)	Lead/Ball Finish	MSL Peak Temp (3)	Op Temp (°C)	Top-Side Markings (4)	Samples
LM49150TL/NOPB	ACTIVE	DSBGA	YZR	20	250	Green (RoHS & no Sb/Br)	SNAGCU	Level-1-260C-UNLIM	-40 to 85	GK7	Samples
LM49150TLX/NOPB	ACTIVE	DSBGA	YZR	20	3000	Green (RoHS & no Sb/Br)	SNAGCU	Level-1-260C-UNLIM	-40 to 85	GK7	Samples

(1) The marketing status values are defined as follows:

ACTIVE: Product device recommended for new designs.

LIFEBUY: TI has announced that the device will be discontinued, and a lifetime-buy period is in effect.

NRND: Not recommended for new designs. Device is in production to support existing customers, but TI does not recommend using this part in a new design.

PREVIEW: Device has been announced but is not in production. Samples may or may not be available.

OBSOLETE: TI has discontinued the production of the device.

(2) Eco Plan - The planned eco-friendly classification: Pb-Free (RoHS), Pb-Free (RoHS Exempt), or Green (RoHS & no Sb/Br) - please check <http://www.ti.com/productcontent> for the latest availability information and additional product content details.

TBD: The Pb-Free/Green conversion plan has not been defined.

Pb-Free (RoHS): TI's terms "Lead-Free" or "Pb-Free" mean semiconductor products that are compatible with the current RoHS requirements for all 6 substances, including the requirement that lead not exceed 0.1% by weight in homogeneous materials. Where designed to be soldered at high temperatures, TI Pb-Free products are suitable for use in specified lead-free processes.

Pb-Free (RoHS Exempt): This component has a RoHS exemption for either 1) lead-based flip-chip solder bumps used between the die and package, or 2) lead-based die adhesive used between the die and leadframe. The component is otherwise considered Pb-Free (RoHS compatible) as defined above.

Green (RoHS & no Sb/Br): TI defines "Green" to mean Pb-Free (RoHS compatible), and free of Bromine (Br) and Antimony (Sb) based flame retardants (Br or Sb do not exceed 0.1% by weight in homogeneous material)

(3) MSL, Peak Temp. -- The Moisture Sensitivity Level rating according to the JEDEC industry standard classifications, and peak solder temperature.

(4) Only one of markings shown within the brackets will appear on the physical device.

Important Information and Disclaimer: The information provided on this page represents TI's knowledge and belief as of the date that it is provided. TI bases its knowledge and belief on information provided by third parties, and makes no representation or warranty as to the accuracy of such information. Efforts are underway to better integrate information from third parties. TI has taken and continues to take reasonable steps to provide representative and accurate information but may not have conducted destructive testing or chemical analysis on incoming materials and chemicals. TI and TI suppliers consider certain information to be proprietary, and thus CAS numbers and other limited information may not be available for release.

In no event shall TI's liability arising out of such information exceed the total purchase price of the TI part(s) at issue in this document sold by TI to Customer on an annual basis.

TAPE AND REEL INFORMATION

QUADRANT ASSIGNMENTS FOR PIN 1 ORIENTATION IN TAPE

*All dimensions are nominal

Device	Package Type	Package Drawing	Pins	SPQ	Reel Diameter (mm)	Reel Width W1 (mm)	A0 (mm)	B0 (mm)	K0 (mm)	P1 (mm)	W (mm)	Pin1 Quadrant
LM49150TL/NOPB	DSBGA	YZR	20	250	178.0	8.4	2.34	2.85	0.76	4.0	8.0	Q1
LM49150TLX/NOPB	DSBGA	YZR	20	3000	178.0	8.4	2.34	2.85	0.76	4.0	8.0	Q1

TAPE AND REEL BOX DIMENSIONS

*All dimensions are nominal

Device	Package Type	Package Drawing	Pins	SPQ	Length (mm)	Width (mm)	Height (mm)
LM49150TL/NOPB	DSBGA	YZR	20	250	210.0	185.0	35.0
LM49150TLX/NOPB	DSBGA	YZR	20	3000	210.0	185.0	35.0

YZR0020

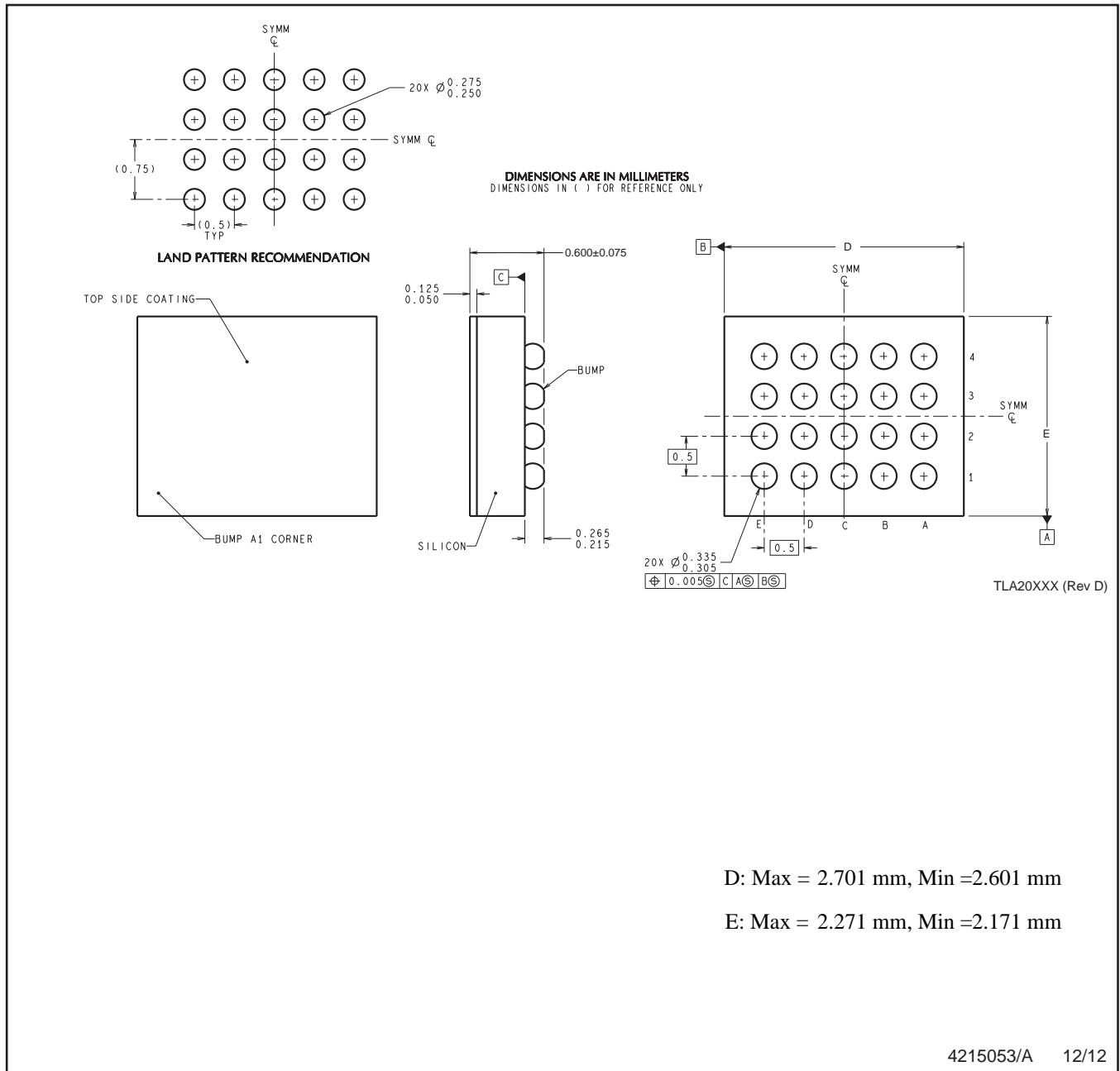

D: Max = 2.701 mm, Min = 2.601 mm

E: Max = 2.271 mm, Min = 2.171 mm

4215053/A 12/12

NOTES: A. All linear dimensions are in millimeters. Dimensioning and tolerancing per ASME Y14.5M-1994.
B. This drawing is subject to change without notice.

IMPORTANT NOTICE

Texas Instruments Incorporated and its subsidiaries (TI) reserve the right to make corrections, enhancements, improvements and other changes to its semiconductor products and services per JESD46, latest issue, and to discontinue any product or service per JESD48, latest issue. Buyers should obtain the latest relevant information before placing orders and should verify that such information is current and complete. All semiconductor products (also referred to herein as "components") are sold subject to TI's terms and conditions of sale supplied at the time of order acknowledgment.

TI warrants performance of its components to the specifications applicable at the time of sale, in accordance with the warranty in TI's terms and conditions of sale of semiconductor products. Testing and other quality control techniques are used to the extent TI deems necessary to support this warranty. Except where mandated by applicable law, testing of all parameters of each component is not necessarily performed.

TI assumes no liability for applications assistance or the design of Buyers' products. Buyers are responsible for their products and applications using TI components. To minimize the risks associated with Buyers' products and applications, Buyers should provide adequate design and operating safeguards.

TI does not warrant or represent that any license, either express or implied, is granted under any patent right, copyright, mask work right, or other intellectual property right relating to any combination, machine, or process in which TI components or services are used. Information published by TI regarding third-party products or services does not constitute a license to use such products or services or a warranty or endorsement thereof. Use of such information may require a license from a third party under the patents or other intellectual property of the third party, or a license from TI under the patents or other intellectual property of TI.

Reproduction of significant portions of TI information in TI data books or data sheets is permissible only if reproduction is without alteration and is accompanied by all associated warranties, conditions, limitations, and notices. TI is not responsible or liable for such altered documentation. Information of third parties may be subject to additional restrictions.

Resale of TI components or services with statements different from or beyond the parameters stated by TI for that component or service voids all express and any implied warranties for the associated TI component or service and is an unfair and deceptive business practice. TI is not responsible or liable for any such statements.

Buyer acknowledges and agrees that it is solely responsible for compliance with all legal, regulatory and safety-related requirements concerning its products, and any use of TI components in its applications, notwithstanding any applications-related information or support that may be provided by TI. Buyer represents and agrees that it has all the necessary expertise to create and implement safeguards which anticipate dangerous consequences of failures, monitor failures and their consequences, lessen the likelihood of failures that might cause harm and take appropriate remedial actions. Buyer will fully indemnify TI and its representatives against any damages arising out of the use of any TI components in safety-critical applications.

In some cases, TI components may be promoted specifically to facilitate safety-related applications. With such components, TI's goal is to help enable customers to design and create their own end-product solutions that meet applicable functional safety standards and requirements. Nonetheless, such components are subject to these terms.

No TI components are authorized for use in FDA Class III (or similar life-critical medical equipment) unless authorized officers of the parties have executed a special agreement specifically governing such use.

Only those TI components which TI has specifically designated as military grade or "enhanced plastic" are designed and intended for use in military/aerospace applications or environments. Buyer acknowledges and agrees that any military or aerospace use of TI components which have **not** been so designated is solely at the Buyer's risk, and that Buyer is solely responsible for compliance with all legal and regulatory requirements in connection with such use.

TI has specifically designated certain components as meeting ISO/TS16949 requirements, mainly for automotive use. In any case of use of non-designated products, TI will not be responsible for any failure to meet ISO/TS16949.

Products

Audio	www.ti.com/audio
Amplifiers	amplifier.ti.com
Data Converters	dataconverter.ti.com
DLP® Products	www.dlp.com
DSP	dsp.ti.com
Clocks and Timers	www.ti.com/clocks
Interface	interface.ti.com
Logic	logic.ti.com
Power Mgmt	power.ti.com
Microcontrollers	microcontroller.ti.com
RFID	www.ti-rfid.com
OMAP Applications Processors	www.ti.com/omap
Wireless Connectivity	www.ti.com/wirelessconnectivity

Applications

Automotive and Transportation	www.ti.com/automotive
Communications and Telecom	www.ti.com/communications
Computers and Peripherals	www.ti.com/computers
Consumer Electronics	www.ti.com/consumer-apps
Energy and Lighting	www.ti.com/energy
Industrial	www.ti.com/industrial
Medical	www.ti.com/medical
Security	www.ti.com/security
Space, Avionics and Defense	www.ti.com/space-avionics-defense
Video and Imaging	www.ti.com/video

TI E2E Community

e2e.ti.com

Mouser Electronics

Authorized Distributor

Click to View Pricing, Inventory, Delivery & Lifecycle Information:

[Texas Instruments:](#)

[LM49150TLEVAL](#)