

## LM160/LM360 High Speed Differential Comparator

 Check for Samples: [LM160](#), [LM360](#)

### FEATURES

- Ensured high speed: 20 ns max
- Tight delay matching on both outputs
- Complementary TTL outputs
- High input impedance
- Low speed variation with overdrive variation
- Fan-out of 4
- Low input offset voltage
- Series 74 TTL compatible

### DESCRIPTION

The LM160/LM360 is a very high speed differential input, complementary TTL output voltage comparator with improved characteristics over the  $\mu$ A760/ $\mu$ A760C, for which it is a pin-for-pin replacement. The device has been optimized for greater speed, input impedance and fan-out, and lower input offset voltage. Typically delay varies only 3 ns for overdrive variations of 5 mV to 400 mV.

Complementary outputs having minimum skew are provided. Applications involve high speed analog to digital convertors and zero-crossing detectors in disk file systems.

### CONNECTION DIAGRAMS

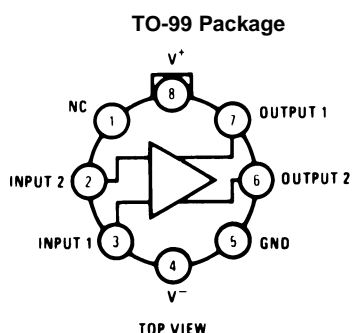

Figure 1. Package Number LMC0008C <sup>(1)</sup>

(1) Also available in SMD# 5962-8767401

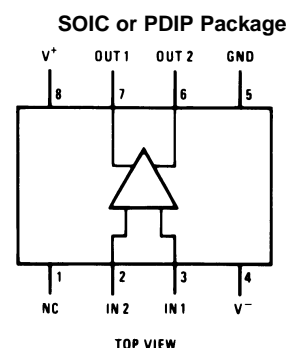

Figure 2. Package Number D0008A or P0008E



These devices have limited built-in ESD protection. The leads should be shorted together or the device placed in conductive foam during storage or handling to prevent electrostatic damage to the MOS gates.



Please be aware that an important notice concerning availability, standard warranty, and use in critical applications of Texas Instruments semiconductor products and disclaimers thereto appears at the end of this data sheet.

All trademarks are the property of their respective owners.

**Absolute Maximum Ratings** <sup>(1)</sup> <sup>(2)</sup>

Positive Supply Voltage		+8V
Negative Supply Voltage		-8V
Peak Output Current		20 mA
Differential Input Voltage		±5V
Input Voltage		$V^+ \geq V_{IN} \geq V^-$
ESD Tolerance <sup>(3)</sup>		1600V
Operating Temperature Range	LM160	-55°C to +125°C
	LM360	0°C to +70°C
Storage Temperature Range		-65°C to +150°C
Lead Temperature	(Soldering, 10 sec.)	260°C
Soldering Information		
PDIP Package	Soldering (10 seconds)	260°C
SOIC Package	Vapor Phase (60 seconds)	215°C
	Infrared (15 seconds)	220°C
See AN-450 "Surface Mounting Methods and Their Effect on Product Reliability" for other methods of soldering surface mount devices.		

- (1) The device may be damaged if used beyond the maximum ratings.  
(2) Refer to RETS 160X for LM160H, LM160J-14 and LM160J military specifications.  
(3) Human body model, 1.5 kΩ in series with 100 pF.

## Electrical Characteristics

 $(T_{MIN} \leq T_A \leq T_{MAX})$ 

Parameter	Conditions	Min	Typ	Max	Units
Operating Conditions					
Supply Voltage $V_{CC}^+$		4.5	5	6.5	V
Supply Voltage $V_{CC}^-$		-4.5	-5	-6.5	V
Input Offset Voltage	$R_S \leq 200\Omega$		2	5	mV
Input Offset Current			0.5	3	$\mu$ A
Input Bias Current			5	20	$\mu$ A
Output Resistance (Either Output)	$V_{OUT} = V_{OH}$		100		$\Omega$
Response Time	$T_A = 25^\circ\text{C}, V_S = \pm 5\text{V}$ <sup>(1)</sup> <sup>(2)</sup>		13	25	ns
	$T_A = 25^\circ\text{C}, V_S = \pm 5\text{V}$ <sup>(3)</sup> <sup>(2)</sup>		12	20	ns
	$T_A = 25^\circ\text{C}, V_S = \pm 5\text{V}$ <sup>(4)</sup> <sup>(2)</sup>		14		ns
Response Time Difference between Outputs					
$(t_{pd} \text{ of } +V_{IN1}) - (t_{pd} \text{ of } -V_{IN2})$	$T_A = 25^\circ\text{C}$ <sup>(1)</sup> <sup>(2)</sup>		2		ns
$(t_{pd} \text{ of } +V_{IN2}) - (t_{pd} \text{ of } -V_{IN1})$	$T_A = 25^\circ\text{C}$ <sup>(1)</sup> <sup>(2)</sup>		2		ns
$(t_{pd} \text{ of } +V_{IN1}) - (t_{pd} \text{ of } +V_{IN2})$	$T_A = 25^\circ\text{C}$ <sup>(1)</sup> <sup>(2)</sup>		2		ns
$(t_{pd} \text{ of } -V_{IN1}) - (t_{pd} \text{ of } -V_{IN2})$	$T_A = 25^\circ\text{C}$ <sup>(1)</sup> <sup>(2)</sup>		2		ns
Input Resistance	$f = 1 \text{ MHz}$		17		k $\Omega$
Input Capacitance	$f = 1 \text{ MHz}$		3		pF
Average Temperature Coefficient of Input Offset Voltage	$R_S = 50\Omega$		8		$\mu\text{V}/^\circ\text{C}$
Average Temperature Coefficient of Input Offset Current			7		nA/ $^\circ\text{C}$
Common Mode Input Voltage Range	$V_S = \pm 6.5\text{V}$	$\pm 4$	$\pm 4.5$		V
Differential Input Voltage Range		$\pm 5$			V
Output High Voltage (Either Output)	$I_{OUT} = -320 \mu\text{A}, V_S = \pm 4.5\text{V}$	2.4	3		V
Output Low Voltage (Either Output)	$I_{SINK} = 6.4 \text{ mA}$		0.25	0.4	V
Positive Supply Current	$V_S = \pm 6.5\text{V}$		18	32	mA
Negative Supply Current	$V_S = \pm 6.5\text{V}$		-9	-16	mA

- (1) Response time measured from the 50% point of a 30 mVp-p 10 MHz sinusoidal input to the 50% point of the output.
- (2) Measurements are made in AC Test Circuit, Fanout = 1
- (3) Response time measured from the 50% point of a 2 Vp-p 10 MHz sinusoidal input to the 50% point of the output.
- (4) Response time measured from the start of a 100 mV input step with 5 mV overdrive to the time when the output crosses the logic threshold.

### Typical Performance Characteristics

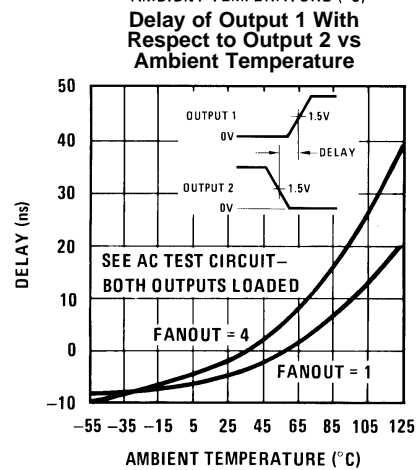
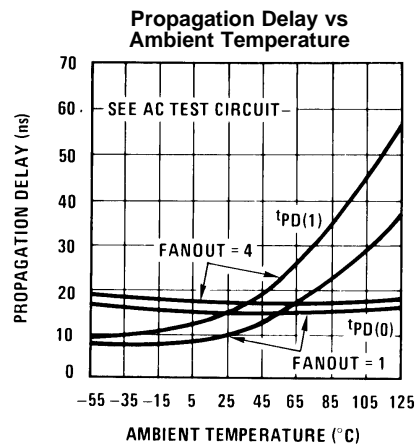
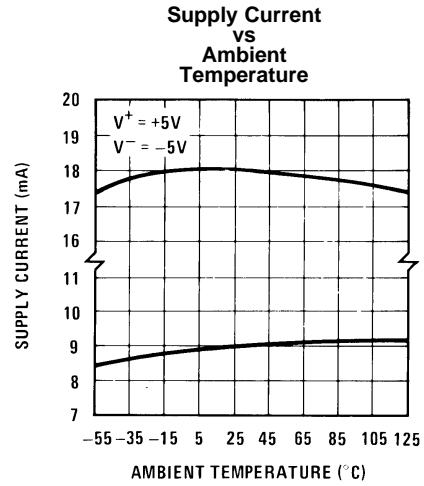
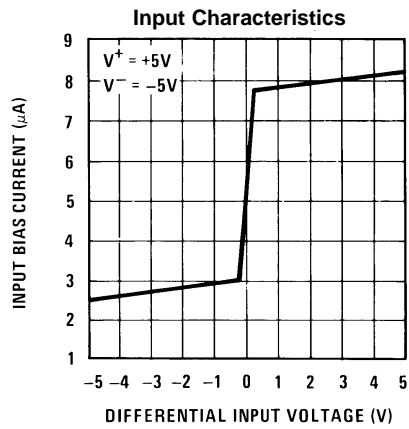
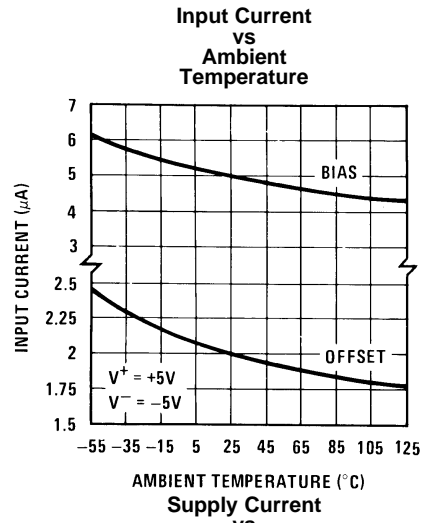
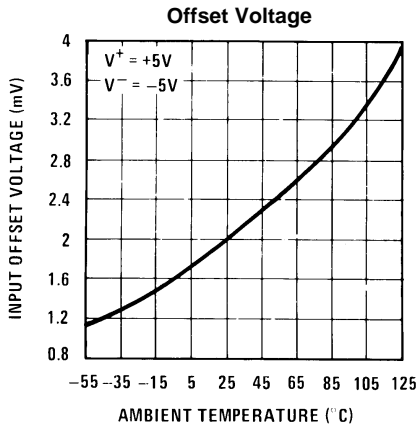

Typical Performance Characteristics (continued)  
Common-Mode  
Pulse Response

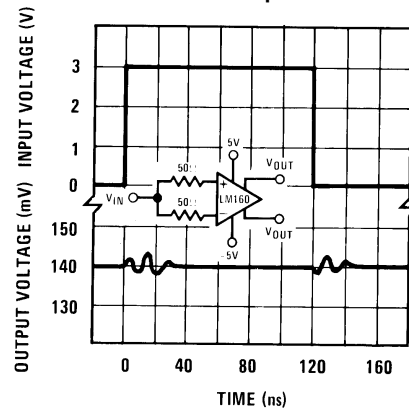

AC TEST CIRCUIT

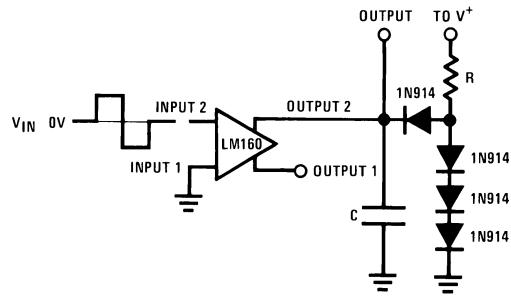

$V_{IN} = \pm 50 \text{ mV}$	FANOUT=1	FANOUT=4
$V^+ = +5V$	$R = 2.4k$	$R = 630\Omega$
$V^- = -5V$	$C = 15 \text{ pF}$	$C = 30 \text{ pF}$



## REVISION HISTORY

Changes from Revision B (March 2013) to Revision C	Page
• Changed layout of National Data Sheet to TI format .....	<a href="#">7</a>



**PACKAGING INFORMATION**

Orderable Device	Status (1)	Package Type	Package Drawing	Pins	Package Qty	Eco Plan (2)	Lead/Ball Finish (6)	MSL Peak Temp (3)	Op Temp (°C)	Device Marking (4/5)	Samples
LM360M	NRND	SOIC	D	8	95	TBD	Call TI	Call TI	0 to 70	LM 360M	
LM360M/NOPB	ACTIVE	SOIC	D	8	95	Green (RoHS & no Sb/Br)	CU SN	Level-1-260C-UNLIM	0 to 70	LM 360M	Samples
LM360MX	NRND	SOIC	D	8	2500	TBD	Call TI	Call TI	0 to 70	LM 360M	
LM360MX/NOPB	ACTIVE	SOIC	D	8	2500	Green (RoHS & no Sb/Br)	CU SN	Level-1-260C-UNLIM	0 to 70	LM 360M	Samples

(1) The marketing status values are defined as follows:

**ACTIVE:** Product device recommended for new designs.

**LIFEBUY:** TI has announced that the device will be discontinued, and a lifetime-buy period is in effect.

**NRND:** Not recommended for new designs. Device is in production to support existing customers, but TI does not recommend using this part in a new design.

**PREVIEW:** Device has been announced but is not in production. Samples may or may not be available.

**OBSELETE:** TI has discontinued the production of the device.

(2) Eco Plan - The planned eco-friendly classification: Pb-Free (RoHS), Pb-Free (RoHS Exempt), or Green (RoHS & no Sb/Br) - please check <http://www.ti.com/productcontent> for the latest availability information and additional product content details.

**TBD:** The Pb-Free/Green conversion plan has not been defined.

**Pb-Free (RoHS):** TI's terms "Lead-Free" or "Pb-Free" mean semiconductor products that are compatible with the current RoHS requirements for all 6 substances, including the requirement that lead not exceed 0.1% by weight in homogeneous materials. Where designed to be soldered at high temperatures, TI Pb-Free products are suitable for use in specified lead-free processes.

**Pb-Free (RoHS Exempt):** This component has a RoHS exemption for either 1) lead-based flip-chip solder bumps used between the die and package, or 2) lead-based die adhesive used between the die and leadframe. The component is otherwise considered Pb-Free (RoHS compatible) as defined above.

**Green (RoHS & no Sb/Br):** TI defines "Green" to mean Pb-Free (RoHS compatible), and free of Bromine (Br) and Antimony (Sb) based flame retardants (Br or Sb do not exceed 0.1% by weight in homogeneous material)

(3) MSL, Peak Temp. - The Moisture Sensitivity Level rating according to the JEDEC industry standard classifications, and peak solder temperature.

(4) There may be additional marking, which relates to the logo, the lot trace code information, or the environmental category on the device.

(5) Multiple Device Markings will be inside parentheses. Only one Device Marking contained in parentheses and separated by a "~" will appear on a device. If a line is indented then it is a continuation of the previous line and the two combined represent the entire Device Marking for that device.

(6) Lead/Ball Finish - Orderable Devices may have multiple material finish options. Finish options are separated by a vertical ruled line. Lead/Ball Finish values may wrap to two lines if the finish value exceeds the maximum column width.

**Important Information and Disclaimer:** The information provided on this page represents TI's knowledge and belief as of the date that it is provided. TI bases its knowledge and belief on information provided by third parties, and makes no representation or warranty as to the accuracy of such information. Efforts are underway to better integrate information from third parties. TI has taken and continues to take reasonable steps to provide representative and accurate information but may not have conducted destructive testing or chemical analysis on incoming materials and chemicals. TI and TI suppliers consider certain information to be proprietary, and thus CAS numbers and other limited information may not be available for release.

In no event shall TI's liability arising out of such information exceed the total purchase price of the TI part(s) at issue in this document sold by TI to Customer on an annual basis.

**TAPE AND REEL INFORMATION**

**QUADRANT ASSIGNMENTS FOR PIN 1 ORIENTATION IN TAPE**

\*All dimensions are nominal

Device	Package Type	Package Drawing	Pins	SPQ	Reel Diameter (mm)	Reel Width W1 (mm)	A0 (mm)	B0 (mm)	K0 (mm)	P1 (mm)	W (mm)	Pin1 Quadrant
LM360MX	SOIC	D	8	2500	330.0	12.4	6.5	5.4	2.0	8.0	12.0	Q1
LM360MX/NOPB	SOIC	D	8	2500	330.0	12.4	6.5	5.4	2.0	8.0	12.0	Q1

**TAPE AND REEL BOX DIMENSIONS**

\*All dimensions are nominal

Device	Package Type	Package Drawing	Pins	SPQ	Length (mm)	Width (mm)	Height (mm)
LM360MX	SOIC	D	8	2500	367.0	367.0	35.0
LM360MX/NOPB	SOIC	D	8	2500	367.0	367.0	35.0

D (R-PDSO-G8)

PLASTIC SMALL OUTLINE



NOTES: A. All linear dimensions are in inches (millimeters).  
 B. This drawing is subject to change without notice.  
 C. Body length does not include mold flash, protrusions, or gate burrs. Mold flash, protrusions, or gate burrs shall not exceed 0.006 (0,15) each side.  
 D. Body width does not include interlead flash. Interlead flash shall not exceed 0.017 (0,43) each side.  
 E. Reference JEDEC MS-012 variation AA.

## IMPORTANT NOTICE

Texas Instruments Incorporated and its subsidiaries (TI) reserve the right to make corrections, enhancements, improvements and other changes to its semiconductor products and services per JESD46, latest issue, and to discontinue any product or service per JESD48, latest issue. Buyers should obtain the latest relevant information before placing orders and should verify that such information is current and complete. All semiconductor products (also referred to herein as "components") are sold subject to TI's terms and conditions of sale supplied at the time of order acknowledgment.

TI warrants performance of its components to the specifications applicable at the time of sale, in accordance with the warranty in TI's terms and conditions of sale of semiconductor products. Testing and other quality control techniques are used to the extent TI deems necessary to support this warranty. Except where mandated by applicable law, testing of all parameters of each component is not necessarily performed.

TI assumes no liability for applications assistance or the design of Buyers' products. Buyers are responsible for their products and applications using TI components. To minimize the risks associated with Buyers' products and applications, Buyers should provide adequate design and operating safeguards.

TI does not warrant or represent that any license, either express or implied, is granted under any patent right, copyright, mask work right, or other intellectual property right relating to any combination, machine, or process in which TI components or services are used. Information published by TI regarding third-party products or services does not constitute a license to use such products or services or a warranty or endorsement thereof. Use of such information may require a license from a third party under the patents or other intellectual property of the third party, or a license from TI under the patents or other intellectual property of TI.

Reproduction of significant portions of TI information in TI data books or data sheets is permissible only if reproduction is without alteration and is accompanied by all associated warranties, conditions, limitations, and notices. TI is not responsible or liable for such altered documentation. Information of third parties may be subject to additional restrictions.

Resale of TI components or services with statements different from or beyond the parameters stated by TI for that component or service voids all express and any implied warranties for the associated TI component or service and is an unfair and deceptive business practice. TI is not responsible or liable for any such statements.

Buyer acknowledges and agrees that it is solely responsible for compliance with all legal, regulatory and safety-related requirements concerning its products, and any use of TI components in its applications, notwithstanding any applications-related information or support that may be provided by TI. Buyer represents and agrees that it has all the necessary expertise to create and implement safeguards which anticipate dangerous consequences of failures, monitor failures and their consequences, lessen the likelihood of failures that might cause harm and take appropriate remedial actions. Buyer will fully indemnify TI and its representatives against any damages arising out of the use of any TI components in safety-critical applications.

In some cases, TI components may be promoted specifically to facilitate safety-related applications. With such components, TI's goal is to help enable customers to design and create their own end-product solutions that meet applicable functional safety standards and requirements. Nonetheless, such components are subject to these terms.

No TI components are authorized for use in FDA Class III (or similar life-critical medical equipment) unless authorized officers of the parties have executed a special agreement specifically governing such use.

Only those TI components which TI has specifically designated as military grade or "enhanced plastic" are designed and intended for use in military/aerospace applications or environments. Buyer acknowledges and agrees that any military or aerospace use of TI components which have **not** been so designated is solely at the Buyer's risk, and that Buyer is solely responsible for compliance with all legal and regulatory requirements in connection with such use.

TI has specifically designated certain components as meeting ISO/TS16949 requirements, mainly for automotive use. In any case of use of non-designated products, TI will not be responsible for any failure to meet ISO/TS16949.

### Products

Audio	<a href="http://www.ti.com/audio">www.ti.com/audio</a>
Amplifiers	<a href="http://amplifier.ti.com">amplifier.ti.com</a>
Data Converters	<a href="http://dataconverter.ti.com">dataconverter.ti.com</a>
DLP® Products	<a href="http://www.dlp.com">www.dlp.com</a>
DSP	<a href="http://dsp.ti.com">dsp.ti.com</a>
Clocks and Timers	<a href="http://www.ti.com/clocks">www.ti.com/clocks</a>
Interface	<a href="http://interface.ti.com">interface.ti.com</a>
Logic	<a href="http://logic.ti.com">logic.ti.com</a>
Power Mgmt	<a href="http://power.ti.com">power.ti.com</a>
Microcontrollers	<a href="http://microcontroller.ti.com">microcontroller.ti.com</a>
RFID	<a href="http://www.ti-rfid.com">www.ti-rfid.com</a>
OMAP Applications Processors	<a href="http://www.ti.com/omap">www.ti.com/omap</a>
Wireless Connectivity	<a href="http://www.ti.com/wirelessconnectivity">www.ti.com/wirelessconnectivity</a>

### Applications

Automotive and Transportation	<a href="http://www.ti.com/automotive">www.ti.com/automotive</a>
Communications and Telecom	<a href="http://www.ti.com/communications">www.ti.com/communications</a>
Computers and Peripherals	<a href="http://www.ti.com/computers">www.ti.com/computers</a>
Consumer Electronics	<a href="http://www.ti.com/consumer-apps">www.ti.com/consumer-apps</a>
Energy and Lighting	<a href="http://www.ti.com/energy">www.ti.com/energy</a>
Industrial	<a href="http://www.ti.com/industrial">www.ti.com/industrial</a>
Medical	<a href="http://www.ti.com/medical">www.ti.com/medical</a>
Security	<a href="http://www.ti.com/security">www.ti.com/security</a>
Space, Avionics and Defense	<a href="http://www.ti.com/space-avionics-defense">www.ti.com/space-avionics-defense</a>
Video and Imaging	<a href="http://www.ti.com/video">www.ti.com/video</a>

### TI E2E Community

[e2e.ti.com](http://e2e.ti.com)

# Mouser Electronics

Authorized Distributor

Click to View Pricing, Inventory, Delivery & Lifecycle Information:

[Texas Instruments:](#)

[LM360M](#) [LM360M/NOPB](#) [LM360MX](#) [LM360MX/NOPB](#)