



Inductors for High Frequency

Multilayer Ceramic

MLG series

MLG0603S	0603 [0201 inch]*
MLG1005S	1005 [0402 inch]
MLG1608	1608 [0603 inch]

* Dimensions Code JIS[EIA]

REMINDERS FOR USING THESE PRODUCTS

Before using these products, be sure to request the delivery specifications.

SAFETY REMINDERS

Please pay sufficient attention to the warnings for safe designing when using these products.

REMINDERS

- The storage period is less than 12 months. Be sure to follow the storage conditions (Temperature: 5 to 40°C, Humidity: 10 to 75% RH or less).
If the storage period elapses, the soldering of the terminal electrodes may deteriorate.
- Do not use or store in locations where there are conditions such as gas corrosion (salt, acid, alkali, etc.).
- Before soldering, be sure to preheat components.
The preheating temperature should be set so that the temperature difference between the solder temperature and chip temperature does not exceed 150°C.
- Soldering corrections after mounting should be within the range of the conditions determined in the specifications.
If overheated, a short circuit, performance deterioration, or lifespan shortening may occur.
- When embedding a printed circuit board where a chip is mounted to a set, be sure that residual stress is not given to the chip due to the overall distortion of the printed circuit board and partial distortion such as at screw tightening portions.
- Self heating (temperature increase) occurs when the power is turned ON, so the tolerance should be sufficient for the set thermal design.
- Carefully lay out the coil for the circuit board design of the non-magnetic shield type.
A malfunction may occur due to magnetic interference.
- Use a wrist band to discharge static electricity in your body through the grounding wire.
- Do not expose the products to magnets or magnetic fields.
- Do not use for a purpose outside of the contents regulated in the delivery specifications.
- The products listed on this catalog are intended for use in general electronic equipment (AV equipment, telecommunications equipment, home appliances, amusement equipment, computer equipment, personal equipment, office equipment, measurement equipment, industrial robots) under a normal operation and use condition.
The products are not designed or warranted to meet the requirements of the applications listed below, whose performance and/or quality require a more stringent level of safety or reliability, or whose failure, malfunction or trouble could cause serious damage to society, person or property.
If you intend to use the products in the applications listed below or if you have special requirements exceeding the range or conditions set forth in the each catalog, please contact us.

- (1) Aerospace/Aviation equipment
- (2) Transportation equipment (cars, electric trains, ships, etc.)
- (3) Medical equipment
- (4) Power-generation control equipment
- (5) Atomic energy-related equipment
- (6) Seabed equipment
- (7) Transportation control equipment

- (8) Public information-processing equipment
- (9) Military equipment
- (10) Electric heating apparatus, burning equipment
- (11) Disaster prevention/crime prevention equipment
- (12) Safety equipment
- (13) Other applications that are not considered general-purpose applications

When designing your equipment even for general-purpose applications, you are kindly requested to take into consideration securing protection circuit/device or providing backup circuits in your equipment.

Inductors for High Frequency Circuits

Multilayer Ceramic

Product compatible with RoHS directive
Halogen-free
Compatible with lead-free solders
AEC-Q200

Overview of the MLG Series

FEATURES

- Advanced monolithic structure is formed using a multilayering and sintering process with ceramic and conductive materials for High-frequency.

APPLICATION

Smart phones, tablet terminals, high frequency modules (PAs, VCOs, FEMs, etc.), Bluetooth, W-LAN, UWB, tuners, automotive equipment and other high frequency circuits for the mobile communication industry

PART NUMBER CONSTRUCTION

MLG	0603	S	0N3	S	T							
Series name	LxWxH Dimensions (mm)		Product internal code		Inductance (nH)		Inductance tolerance		Packaging style		Internal code	
	0603	0.6x0.3x0.3	B		1N1	1.1	B	±0.1nH	T	Taping		
	1005	1.0x0.5x0.5	S		11N	11	C	±0.2nH				
	1608	1.6x0.8x0.8			R10	100	S	±0.3nH				
					1R0	1000	D	±0.5nH				
							H	±3%				
							J	±5%				

OPERATING TEMPERATURE RANGE, PACKAGE QUANTITY, PRODUCT WEIGHT

Type	Temperature range		Package quantity (pieces/reel)	Individual weight (mg)
	Operating temperature (°C)	Storage temperature* (°C)		
	MLG0603S	-55 to +125		
MLG1005S	-55 to +125	-55 to +125	10000	1
MLG1608	-55 to +125	-55 to +125	4000	4

* The Storage temperature range is for after the circuit board is mounted.

- RoHS Directive Compliant Product: See the following for more details related to RoHS Directive compliant products. <http://www.tdk.co.jp/rohs/>
- Halogen-free: Indicates that Cl content is less than 900ppm, Br content is less than 900ppm, and that the total Cl and Br content is less than 1500ppm.

• All specifications are subject to change without notice.

Overview of the MLG Series

RECOMMENDED REFLOW PROFILE



Preheating			Soldering		Peak	
Temp.	Temp.	Time	Temp.	Time	Temp.	Time
T1	T2	t1	T3	t2	T4	t3
150°C	180°C	60 to 120s	230°C	30 to 60s	250 to 260°C	10s max.

MLGseries

MLG0603S Type



SHAPE & DIMENSIONS



Dimensions in mm

RECOMMENDED LAND PATTERN



Dimensions in mm

MLGseries **MLG0603S Type**

■ ELECTRICAL CHARACTERISTICS

□ CHARACTERISTICS SPECIFICATION TABLE

L (nH)	Tolerance	Q min.	L, Q measuring frequency (MHz)	Self-resonant frequency (GHz)		DC resistance (Ω)		Rated current (mA) max.	Part No.*
				min.	typ.	max.	typ.		
0.3	$\pm 0.1, \pm 0.2\text{nH}$	—	100	10.0	20 up	0.1	0.02	600	MLG0603S0N3 Δ T□□□
0.4	$\pm 0.1, \pm 0.2\text{nH}$	—	100	10.0	20 up	0.1	0.02	600	MLG0603S0N4 Δ T□□□
0.5	$\pm 0.1, \pm 0.2\text{nH}$	—	100	10.0	20 up	0.1	0.02	600	MLG0603S0N5 Δ T□□□
0.6	$\pm 0.1, \pm 0.2\text{nH}$	—	100	10.0	20 up	0.1	0.02	600	MLG0603S0N6 Δ T□□□
0.7	$\pm 0.1, \pm 0.2\text{nH}$	—	100	10.0	16.3	0.1	0.02	600	MLG0603S0N7 Δ T□□□
0.8	$\pm 0.1, \pm 0.2\text{nH}$	—	100	10.0	16.1	0.1	0.03	600	MLG0603S0N8 Δ T□□□
0.9	$\pm 0.1, \pm 0.2\text{nH}$	—	100	10.0	13.8	0.1	0.03	600	MLG0603S0N9 Δ T□□□
1.0	$\pm 0.1, \pm 0.2, 0.3\text{nH}$	4	100	10.0	14.4	0.1	0.04	600	MLG0603S1N0 Δ T□□□
1.1	$\pm 0.1, \pm 0.2, 0.3\text{nH}$	4	100	10.0	13.6	0.15	0.04	550	MLG0603S1N1 Δ T□□□
1.2	$\pm 0.1, \pm 0.2, 0.3\text{nH}$	4	100	10.0	12.3	0.15	0.06	550	MLG0603S1N2 Δ T□□□
1.3	$\pm 0.1, \pm 0.2, 0.3\text{nH}$	4	100	9.0	11.4	0.15	0.07	550	MLG0603S1N3 Δ T□□□
1.5	$\pm 0.1, \pm 0.2, 0.3\text{nH}$	4	100	9.0	10.4	0.15	0.07	550	MLG0603S1N5 Δ T□□□
1.6	$\pm 0.1, \pm 0.2, 0.3\text{nH}$	4	100	9.0	11.5	0.2	0.09	500	MLG0603S1N6 Δ T□□□
1.8	$\pm 0.1, \pm 0.2, 0.3\text{nH}$	4	100	8.5	10.0	0.2	0.12	500	MLG0603S1N8 Δ T□□□
2.0	$\pm 0.1, \pm 0.2, 0.3\text{nH}$	4	100	8.2	9.8	0.25	0.14	400	MLG0603S2N0 Δ T□□□
2.2	$\pm 0.1, \pm 0.2, 0.3\text{nH}$	4	100	8.0	8.9	0.25	0.14	400	MLG0603S2N2 Δ T□□□
2.4	$\pm 0.1, \pm 0.2, 0.3\text{nH}$	4	100	8.0	9.2	0.25	0.15	300	MLG0603S2N4 Δ T□□□
2.7	$\pm 0.1, \pm 0.2, 0.3\text{nH}$	4	100	6.5	8.1	0.25	0.15	300	MLG0603S2N7 Δ T□□□
3.0	$\pm 0.1, \pm 0.2, 0.3\text{nH}$	4	100	6.2	7.8	0.3	0.20	300	MLG0603S3N0 Δ T□□□
3.3	$\pm 0.1, \pm 0.2, 0.3\text{nH}$	4	100	5.8	7.0	0.35	0.23	300	MLG0603S3N3 Δ T□□□
3.6	$\pm 0.1, \pm 0.2, 0.3\text{nH}$	4	100	5.5	6.9	0.35	0.22	300	MLG0603S3N6 Δ T□□□
3.9	$\pm 0.1, \pm 0.2, 0.3\text{nH}$	5	100	5.0	6.6	0.4	0.27	300	MLG0603S3N9 Δ T□□□
4.3	$\pm 3\%, \pm 0.3\text{nH}$	5	100	5.0	6.4	0.4	0.27	300	MLG0603S4N3 Δ T□□□
4.7	$\pm 3\%, \pm 0.3\text{nH}$	5	100	4.5	5.4	0.45	0.28	300	MLG0603S4N7 Δ T□□□
5.1	$\pm 3\%, \pm 0.3\text{nH}$	5	100	4.5	5.5	0.45	0.23	250	MLG0603S5N1 Δ T□□□
5.6	$\pm 3\%, \pm 0.3\text{nH}$	5	100	4.2	5.3	0.5	0.31	250	MLG0603S5N6 Δ T□□□
6.2	$\pm 3\%, \pm 0.3\text{nH}$	5	100	4.2	5.1	0.55	0.32	250	MLG0603S6N2 Δ T□□□
6.8	$\pm 3, \pm 5\%$	5	100	3.6	4.4	0.6	0.32	250	MLG0603S6N8 Δ T□□□
7.5	$\pm 3, \pm 5\%$	5	100	4.2	5.3	0.7	0.43	200	MLG0603S7N5 Δ T□□□
8.2	$\pm 3, \pm 5\%$	5	100	3.8	4.5	0.7	0.45	200	MLG0603S8N2 Δ T□□□
9.1	$\pm 3, \pm 5\%$	5	100	3.4	4.9	0.8	0.51	200	MLG0603S9N1 Δ T□□□
10	$\pm 3, \pm 5\%$	5	100	3.2	4.1	0.8	0.53	200	MLG0603S10N Δ T□□□
11	$\pm 3, \pm 5\%$	6	100	3.0	3.7	0.8	0.53	200	MLG0603S11N Δ T□□□
12	$\pm 3, \pm 5\%$	6	100	2.8	3.6	0.9	0.63	180	MLG0603S12N Δ T□□□
13	$\pm 3, \pm 5\%$	6	100	2.7	3.4	0.9	0.60	180	MLG0603S13N Δ T□□□
15	$\pm 3, \pm 5\%$	6	100	2.5	3.3	1.1	0.69	180	MLG0603S15N Δ T□□□
16	$\pm 3, \pm 5\%$	6	100	2.3	3.0	1.1	0.70	180	MLG0603S16N Δ T□□□
18	$\pm 3, \pm 5\%$	6	100	2.2	2.8	1.2	0.78	150	MLG0603S18N Δ T□□□
20	$\pm 3, \pm 5\%$	6	100	2.1	2.6	1.2	0.75	150	MLG0603S20N Δ T□□□
22	$\pm 3, \pm 5\%$	6	100	2.0	2.5	1.2	0.88	150	MLG0603S22N Δ T□□□
24	$\pm 3, \pm 5\%$	6	100	1.9	2.3	1.3	0.90	150	MLG0603S24N Δ T□□□
27	$\pm 3, \pm 5\%$	6	100	1.8	2.2	1.5	1.00	100	MLG0603S27N Δ T□□□
30	$\pm 3, \pm 5\%$	6	100	1.6	2.0	1.6	0.95	100	MLG0603S30N Δ T□□□
33	$\pm 3, \pm 5\%$	6	100	1.6	2.0	1.8	1.20	100	MLG0603S33N Δ T□□□

* The " Δ " of the Part Number contains the inductance tolerance code, B($\pm 0.1\text{nH}$), C($\pm 0.2\text{nH}$), S($\pm 0.3\text{nH}$), H($\pm 3\%$) or J($\pm 5\%$).
Please contact us for information on inductance tolerance, G ($\pm 2\%$).

* The "□□□" of the Part Number contains the internal code.

○ Measurement equipment

Measurement item	Product No.	Manufacturer
L, Q	4291B+16197A	Agilent Technologies
Self-resonant frequency	8720C	Agilent Technologies
DC resistance	Type-7561	Yokogawa

* Equivalent measurement equipment may be used.

• All specifications are subject to change without notice.

MLG_{series} **MLG0603S Type**

■ ELECTRICAL CHARACTERISTICS

□ CHARACTERISTICS SPECIFICATION TABLE

L (nH)	Tolerance	Q min.	L, Q measuring frequency (MHz)	Self-resonant frequency (GHz)		DC resistance (Ω)		Rated current (mA) max.	Part No.*
				min.	typ.	max.	typ.		
36	±3, ±5%	6	100	1.5	1.8	2.0	1.68	50	MLG0603S36N△T□□□
39	±3, ±5%	6	100	1.4	1.6	2.0	1.40	50	MLG0603S39N△T□□□
43	±3, ±5%	6	100	1.3	1.6	2.2	1.91	50	MLG0603S43N△T□□□
47	±3, ±5%	6	100	1.3	1.5	2.2	1.48	50	MLG0603S47N△T□□□
51	±3, ±5%	5	100	1.2	1.5	2.8	1.98	50	MLG0603S51N△T□□□
56	±3, ±5%	5	100	1.2	1.4	3.2	2.11	50	MLG0603S56N△T□□□
62	±3, ±5%	5	100	1.1	1.3	3.3	2.22	50	MLG0603S62N△T□□□
68	±3, ±5%	5	100	1.05	1.24	3.5	2.40	50	MLG0603S68N△T□□□
75	±3, ±5%	5	100	0.95	1.17	3.8	2.67	50	MLG0603S75N△T□□□
82	±3, ±5%	5	100	0.90	1.08	4.0	2.80	50	MLG0603S82N△T□□□
91	±3, ±5%	5	100	0.77	0.94	4.3	2.97	50	MLG0603S91N△T□□□
100	±3, ±5%	5	100	0.77	0.94	4.5	3.13	50	MLG0603SR10△T□□□
110	±3, ±5%	5	100	0.77	0.94	6.5	5.24	50	MLG0603SR11△T□□□
120	±3, ±5%	5	100	0.70	0.88	7.0	5.53	50	MLG0603SR12△T□□□
130	±3, ±5%	5	100	0.67	0.84	7.3	5.68	50	MLG0603SR13△T□□□
150	±3, ±5%	5	100	0.64	0.77	8.0	6.24	50	MLG0603SR15△T□□□
160	±3, ±5%	5	100	0.60	0.73	8.3	6.67	50	MLG0603SR16△T□□□
180	±3, ±5%	5	100	0.56	0.68	8.5	6.99	50	MLG0603SR18△T□□□

* The "△" of the Part Number contains the inductance tolerance code, B(±0.1nH), C(±0.2nH), S(±0.3nH), H(±3%) or J(±5%).
Please contact us for information on inductance tolerance, G (±2%).

* The "□□□" of the Part Number contains the internal code.

○ Measurement equipment

Measurement item	Product No.	Manufacturer
L, Q	4291B+16197A	Agilent Technologies
Self-resonant frequency	8720C	Agilent Technologies
DC resistance	Type-7561	Yokogawa

* Equivalent measurement equipment may be used.

MLGseries **MLG0603S Type**

■ ELECTRICAL CHARACTERISTICS

□ L, Q FREQUENCY CHARACTERISTICS TABLE

L(nH)typ.					Q typ.					Part No.*
500MHz	800MHz	1.8GHz	2.0GHz	2.4GHz	500MHz	800MHz	1.8GHz	2.0GHz	2.4GHz	
0.3	0.3	0.3	0.3	0.3	14min.	18min.	29min.	32min.	35min.	MLG0603S0N3△T□□□
0.4	0.4	0.4	0.4	0.4	14min.	18min.	29min.	32min.	35min.	MLG0603S0N4△T□□□
0.5	0.5	0.5	0.5	0.5	14	18	29	32	35	MLG0603S0N5△T□□□
0.6	0.6	0.5	0.5	0.5	16	20	33	34	39	MLG0603S0N6△T□□□
0.7	0.6	0.6	0.6	0.6	16	21	33	35	39	MLG0603S0N7△T□□□
0.7	0.7	0.7	0.7	0.7	15	20	32	34	38	MLG0603S0N8△T□□□
0.8	0.8	0.8	0.8	0.8	15	19	30	32	35	MLG0603S0N9△T□□□
0.9	0.9	0.9	0.9	0.9	14	18	29	30	34	MLG0603S1N0△T□□□
1.0	1.0	1.0	1.0	1.0	14	19	29	31	34	MLG0603S1N1△T□□□
1.1	1.1	1.1	1.1	1.1	14	18	29	30	34	MLG0603S1N2△T□□□
1.2	1.2	1.2	1.2	1.2	14	18	29	30	33	MLG0603S1N3△T□□□
1.4	1.4	1.4	1.4	1.4	15	19	29	30	34	MLG0603S1N5△T□□□
1.5	1.5	1.5	1.5	1.5	14	18	29	30	33	MLG0603S1N6△T□□□
1.7	1.7	1.7	1.7	1.7	15	19	29	30	33	MLG0603S1N8△T□□□
1.9	1.9	1.9	1.9	1.9	14	18	28	29	32	MLG0603S2N0△T□□□
2.1	2.0	2.1	2.1	2.1	14	18	27	28	31	MLG0603S2N2△T□□□
2.2	2.2	2.2	2.3	2.3	14	18	27	29	32	MLG0603S2N4△T□□□
2.5	2.5	2.6	2.6	2.7	15	19	28	29	31	MLG0603S2N7△T□□□
2.8	2.8	2.9	2.9	3.0	15	19	29	31	33	MLG0603S3N0△T□□□
3.1	3.1	3.2	3.3	3.4	15	19	28	29	31	MLG0603S3N3△T□□□
3.4	3.4	3.5	3.6	3.7	14	18	26	27	29	MLG0603S3N6△T□□□
3.7	3.7	3.8	3.9	4.1	15	19	29	29	32	MLG0603S3N9△T□□□
4.1	4.1	4.3	4.4	4.6	14	18	27	27	29	MLG0603S4N3△T□□□
4.4	4.4	4.8	4.9	5.2	15	20	28	29	30	MLG0603S4N7△T□□□
4.8	4.8	5.1	5.3	5.6	14	18	25	26	27	MLG0603S5N1△T□□□
5.3	5.3	5.7	5.9	6.4	16	20	27	28	29	MLG0603S5N6△T□□□
5.9	5.9	6.5	6.8	7.5	15	18	25	25	26	MLG0603S6N2△T□□□
6.4	6.5	7.4	7.8	8.7	15	19	26	26	25	MLG0603S6N8△T□□□
7.1	7.1	7.8	8.0	8.7	14	18	25	26	26	MLG0603S7N5△T□□□
7.8	7.8	8.8	9.3	10.4	15	18	24	24	24	MLG0603S8N2△T□□□
8.6	8.6	9.8	10.3	11.5	14	17	22	22	22	MLG0603S9N1△T□□□
10	10	12	12	15	15	18	23	22	21	MLG0603S10N△T□□□
10	11	13	14	16	15	18	22	22	20	MLG0603S11N△T□□□
11	12	14	15	19	16	19	24	23	20	MLG0603S12N△T□□□
12	13	16	17	22	14	16	19	18	15	MLG0603S13N△T□□□
14	15	20	23	33	15	19	20	18	14	MLG0603S15N△T□□□
15	16	22	25	37	14	16	16	15	11	MLG0603S16N△T□□□
17	18	28	35		14	17	15	13		MLG0603S18N△T□□□
19	20	32			13	16	14			MLG0603S20N△T□□□
21	23	40			15	17	13			MLG0603S22N△T□□□
23	24	45			13	15	13			MLG0603S24N△T□□□
27	29				15	17				MLG0603S27N△T□□□
29	32				13	15				MLG0603S30N△T□□□
33	36				14	16				MLG0603S33N△T□□□

* The "△" of the Part Number contains the inductance tolerance code, B(± 0.1 nH), C(± 0.2 nH), S(± 0.3 nH), H($\pm 3\%$) or J($\pm 5\%$).
Please contact us for information on inductance tolerance, G ($\pm 2\%$).

* The "□□□" of the Part Number contains the internal code.

○ Measurement equipment

Product No.	Manufacturer
4291B+16197A	Agilent Technologies

* Equivalent measurement equipment may be used.

MLG_{series} MLG0603S Type

■ ELECTRICAL CHARACTERISTICS

□ L, Q FREQUENCY CHARACTERISTICS TABLE

L(nH)typ.					Q typ.					Part No.*
500MHz	800MHz	1.8GHz	2.0GHz	2.4GHz	500MHz	800MHz	1.8GHz	2.0GHz	2.4GHz	
36	40				14	15				MLG0603S36N△T□□□
40	47				13	14				MLG0603S39N△T□□□
44	53				14	14				MLG0603S43N△T□□□
49	60				13	13				MLG0603S47N△T□□□
52	64				11	11				MLG0603S51N△T□□□
59	77				12	11				MLG0603S56N△T□□□
66	88				11	10				MLG0603S62N△T□□□
74	104				13	11				MLG0603S68N△T□□□
82	119				10	8				MLG0603S75N△T□□□
96	161				12	8				MLG0603S82N△T□□□
109					9					MLG0603S91N△T□□□
129					11					MLG0603SR10△T□□□
134					10					MLG0603SR11△T□□□
156					9					MLG0603SR12△T□□□
172					8					MLG0603SR13△T□□□
223					7					MLG0603SR15△T□□□
238					7					MLG0603SR16△T□□□
318					6					MLG0603SR18△T□□□

* The "△" of the Part Number contains the inductance tolerance code, B(± 0.1 nH), C(± 0.2 nH), S(± 0.3 nH), H($\pm 3\%$) or J($\pm 5\%$).
Please contact us for information on inductance tolerance, G ($\pm 2\%$).

* The "□□□" of the Part Number contains the internal code.

○ Measurement equipment

Product No.	Manufacturer
4291B+16197A	Agilent Technologies

* Equivalent measurement equipment may be used.

MLGseries MLG0603S Type

ELECTRICAL CHARACTERISTICS

L FREQUENCY CHARACTERISTICS GRAPH (EXAMPLE)

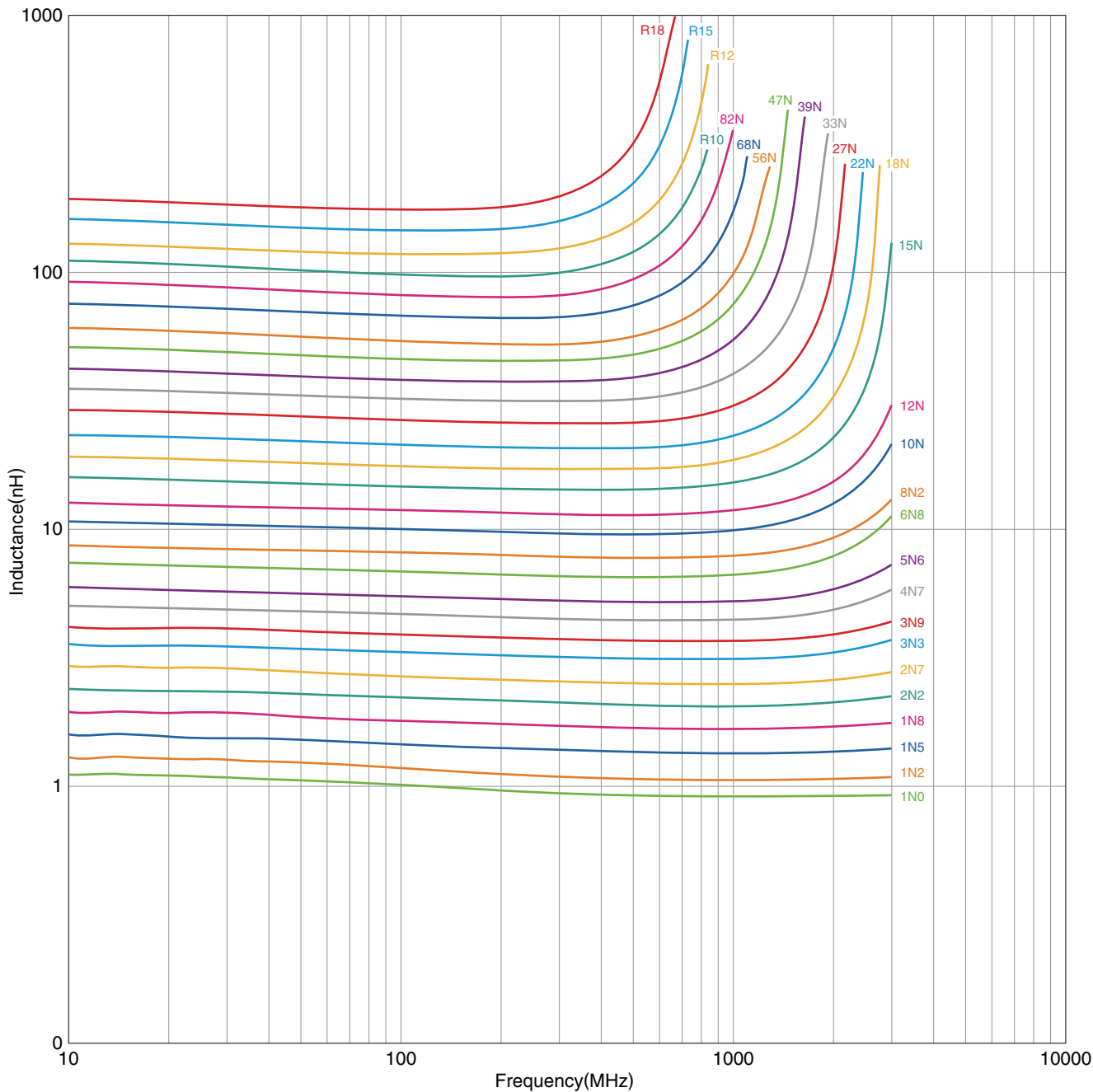

○ Measurement equipment

Product No.	Manufacturer
E4991A +16197A	Agilent Technologies

* Equivalent measurement equipment may be used.

• All specifications are subject to change without notice.

MLG_{series} MLG0603S Type

ELECTRICAL CHARACTERISTICS

Q FREQUENCY CHARACTERISTICS GRAPH (EXAMPLE)

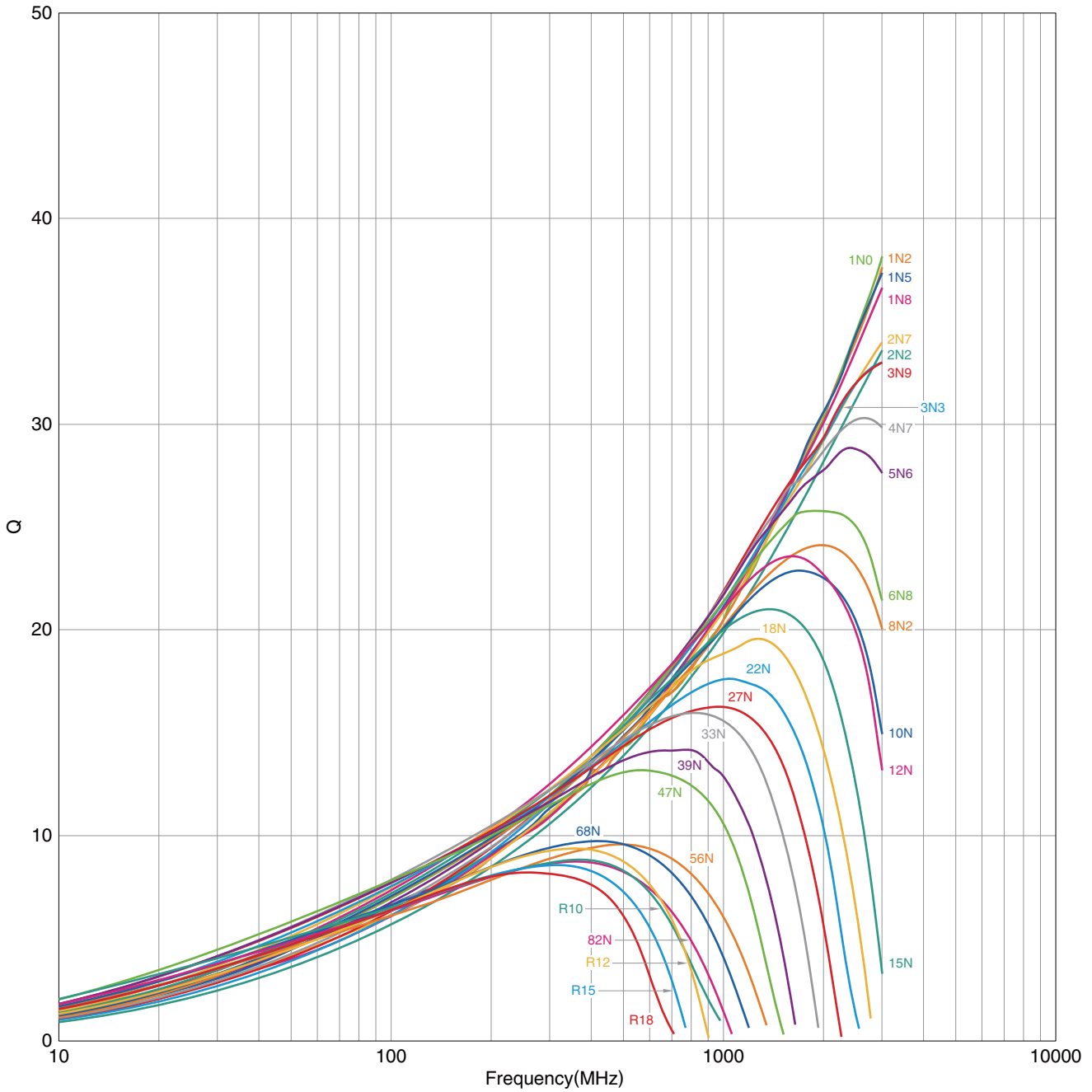

○ Measurement equipment

Product No.	Manufacturer
E4991A +16197A	Agilent Technologies

* Equivalent measurement equipment may be used.

• All specifications are subject to change without notice.

MLGseries

MLG1005S Type



■ SHAPE & DIMENSIONS

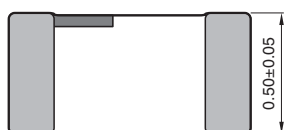
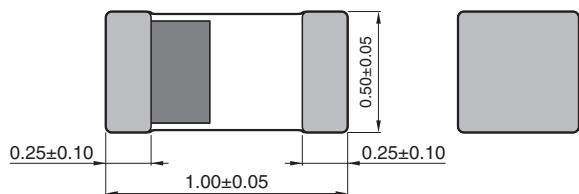

Dimensions in mm

■ RECOMMENDED LAND PATTERN

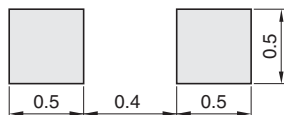

Dimensions in mm

• All specifications are subject to change without notice.

MLGseries **MLG1005S Type**

■ ELECTRICAL CHARACTERISTICS

□ CHARACTERISTICS SPECIFICATION TABLE

L (nH)	Tolerance	Q min.	L, Q measuring frequency (MHz)	Self-resonant frequency (GHz)		DC resistance (Ω)		Rated current (mA) max.	Part No.*
				min.	typ.	max.	typ.		
0.3	$\pm 0.1\text{nH}, \pm 0.2\text{nH}$	—	100	10.0	20up	0.10	0.01	1000	MLG1005S0N3 Δ T□□□
0.4	$\pm 0.1\text{nH}, \pm 0.2\text{nH}$	—	100	10.0	20up	0.10	0.01	1000	MLG1005S0N4 Δ T□□□
0.5	$\pm 0.1\text{nH}, \pm 0.2\text{nH}$	—	100	10.0	20up	0.10	0.01	1000	MLG1005S0N5 Δ T□□□
0.6	$\pm 0.1\text{nH}, \pm 0.2\text{nH}$	—	100	10.0	20up	0.10	0.01	1000	MLG1005S0N6 Δ T□□□
0.7	$\pm 0.1\text{nH}, \pm 0.2\text{nH}$	—	100	10.0	18.7	0.10	0.02	1000	MLG1005S0N7 Δ T□□□
0.8	$\pm 0.1\text{nH}, \pm 0.2\text{nH}$	—	100	10.0	16.4	0.10	0.02	1000	MLG1005S0N8 Δ T□□□
0.9	$\pm 0.1\text{nH}, \pm 0.2\text{nH}$	—	100	10.0	17.7	0.10	0.04	1000	MLG1005S0N9 Δ T□□□
1.0	$\pm 0.1\text{nH}, \pm 0.2, 0.3\text{nH}$	7	100	10.0	13.8	0.10	0.04	1000	MLG1005S1N0 Δ T□□□
1.1	$\pm 0.1\text{nH}, \pm 0.2, 0.3\text{nH}$	7	100	10.0	19.3	0.10	0.03	1000	MLG1005S1N1 Δ T□□□
1.2	$\pm 0.1\text{nH}, \pm 0.2, 0.3\text{nH}$	7	100	10.0	11.6	0.10	0.04	1000	MLG1005S1N2 Δ T□□□
1.3	$\pm 0.1\text{nH}, \pm 0.2, 0.3\text{nH}$	7	100	8.00	11.7	0.10	0.04	1000	MLG1005S1N3 Δ T□□□
1.5	$\pm 0.1\text{nH}, \pm 0.2, 0.3\text{nH}$	7	100	8.00	9.6	0.10	0.06	1000	MLG1005S1N5 Δ T□□□
1.6	$\pm 0.1\text{nH}, \pm 0.2, 0.3\text{nH}$	7	100	7.50	9.4	0.12	0.05	1000	MLG1005S1N6 Δ T□□□
1.8	$\pm 0.1\text{nH}, \pm 0.2, 0.3\text{nH}$	7	100	8.00	10.3	0.15	0.06	900	MLG1005S1N8 Δ T□□□
2.0	$\pm 0.1\text{nH}, \pm 0.2, 0.3\text{nH}$	7	100	7.50	9.3	0.15	0.07	900	MLG1005S2N0 Δ T□□□
2.2	$\pm 0.1\text{nH}, \pm 0.2, 0.3\text{nH}$	7	100	7.00	8.6	0.15	0.08	900	MLG1005S2N2 Δ T□□□
2.4	$\pm 0.1\text{nH}, \pm 0.2, 0.3\text{nH}$	7	100	7.00	8.2	0.15	0.08	800	MLG1005S2N4 Δ T□□□
2.7	$\pm 0.1\text{nH}, \pm 0.2, 0.3\text{nH}$	7	100	6.00	7.3	0.15	0.08	800	MLG1005S2N7 Δ T□□□
3.0	$\pm 0.1\text{nH}, \pm 0.2, 0.3\text{nH}$	7	100	5.50	6.8	0.20	0.09	800	MLG1005S3N0 Δ T□□□
3.3	$\pm 0.1\text{nH}, \pm 0.2, 0.3\text{nH}$	8	100	5.00	6.1	0.20	0.09	800	MLG1005S3N3 Δ T□□□
3.6	$\pm 0.1\text{nH}, \pm 0.2, 0.3\text{nH}$	8	100	5.00	6.7	0.20	0.09	700	MLG1005S3N6 Δ T□□□
3.9	$\pm 0.1\text{nH}, \pm 0.2, 0.3\text{nH}$	8	100	5.00	6.5	0.20	0.11	700	MLG1005S3N9 Δ T□□□
4.3	$\pm 0.2\text{nH}, \pm 0.3\text{nH}$	8	100	4.50	6.0	0.20	0.11	700	MLG1005S4N3 Δ T□□□
4.7	$\pm 0.2\text{nH}, \pm 0.3\text{nH}$	8	100	4.50	5.4	0.25	0.12	700	MLG1005S4N7 Δ T□□□
5.1	$\pm 0.2\text{nH}, \pm 0.3\text{nH}$	8	100	4.00	5.0	0.25	0.13	600	MLG1005S5N1 Δ T□□□
5.6	$\pm 0.2\text{nH}, \pm 0.3\text{nH}$	8	100	4.00	5.3	0.25	0.14	600	MLG1005S5N6 Δ T□□□
6.2	$\pm 3\%, \pm 0.3\text{nH}$	8	100	4.00	4.7	0.25	0.16	600	MLG1005S6N2 Δ T□□□
6.8	$\pm 3\%, \pm 5\%$	8	100	3.50	4.4	0.25	0.15	600	MLG1005S6N8 Δ T□□□
7.5	$\pm 3\%, \pm 5\%$	8	100	3.00	4.1	0.25	0.15	500	MLG1005S7N5 Δ T□□□
8.2	$\pm 3\%, \pm 5\%$	8	100	3.00	4.0	0.30	0.19	500	MLG1005S8N2 Δ T□□□
9.1	$\pm 3\%, \pm 5\%$	8	100	3.00	3.8	0.30	0.20	500	MLG1005S9N1 Δ T□□□
10	$\pm 3\%, \pm 5\%$	8	100	2.50	3.4	0.35	0.22	500	MLG1005S10N Δ T□□□
11	$\pm 3\%, \pm 5\%$	8	100	2.50	3.5	0.40	0.28	400	MLG1005S11N Δ T□□□
12	$\pm 3\%, \pm 5\%$	8	100	2.50	3.0	0.40	0.25	400	MLG1005S12N Δ T□□□
13	$\pm 3\%, \pm 5\%$	8	100	2.40	2.9	0.50	0.26	400	MLG1005S13N Δ T□□□
15	$\pm 3\%, \pm 5\%$	8	100	2.20	2.8	0.55	0.35	400	MLG1005S15N Δ T□□□
16	$\pm 3\%, \pm 5\%$	8	100	2.10	2.7	0.55	0.32	400	MLG1005S16N Δ T□□□
18	$\pm 3\%, \pm 5\%$	8	100	2.00	2.5	0.60	0.40	350	MLG1005S18N Δ T□□□
20	$\pm 3\%, \pm 5\%$	8	100	1.90	2.4	0.60	0.38	350	MLG1005S20N Δ T□□□
22	$\pm 3\%, \pm 5\%$	8	100	1.70	2.2	0.70	0.46	350	MLG1005S22N Δ T□□□
24	$\pm 3\%, \pm 5\%$	8	100	1.70	2.1	0.70	0.43	350	MLG1005S24N Δ T□□□
27	$\pm 3\%, \pm 5\%$	8	100	1.60	2.0	0.80	0.53	300	MLG1005S27N Δ T□□□
30	$\pm 3\%, \pm 5\%$	8	100	1.50	1.9	0.80	0.50	300	MLG1005S30N Δ T□□□

* The " Δ " of the Part Number contains the inductance tolerance code, B($\pm 0.1\text{nH}$), C($\pm 0.2\text{nH}$), S($\pm 0.3\text{nH}$), H($\pm 3\%$) or J($\pm 5\%$).

Please contact us for information on inductance tolerance, G ($\pm 2\%$).

* The "□□□" of the Part Number contains the internal code.

○ Measurement equipment

Measurement item	Product No.	Manufacturer
L, Q	4291B +16193A	Agilent Technologies
Self-resonant frequency	8720C	Agilent Technologies
DC resistance	Type-7561	Yokogawa

* Equivalent measurement equipment may be used.

• All specifications are subject to change without notice.

MLGseries **MLG1005S Type**

■ ELECTRICAL CHARACTERISTICS

□ CHARACTERISTICS SPECIFICATION TABLE

L (nH)	Tolerance	Q min.	L, Q measuring frequency (MHz)	Self-resonant frequency (GHz)		DC resistance (Ω)		Rated current (mA) max.	Part No.*
				min.	typ.	max.	typ.		
33	$\pm 3\%$, $\pm 5\%$	8	100	1.40	1.8	0.90	0.59	300	MLG1005S33N Δ T□□□
36	$\pm 3\%$, $\pm 5\%$	8	100	1.30	1.7	1.00	0.62	250	MLG1005S36N Δ T□□□
39	$\pm 3\%$, $\pm 5\%$	8	100	1.20	1.6	1.00	0.65	250	MLG1005S39N Δ T□□□
43	$\pm 3\%$, $\pm 5\%$	8	100	1.20	1.6	1.10	0.67	250	MLG1005S43N Δ T□□□
47	$\pm 3\%$, $\pm 5\%$	8	100	1.10	1.4	1.20	0.75	250	MLG1005S47N Δ T□□□
51	$\pm 3\%$, $\pm 5\%$	8	100	1.10	1.5	1.20	0.72	250	MLG1005S51N Δ T□□□
56	$\pm 3\%$, $\pm 5\%$	8	100	1.00	1.3	1.30	0.83	200	MLG1005S56N Δ T□□□
62	$\pm 3\%$, $\pm 5\%$	8	100	1.00	1.3	1.40	0.85	200	MLG1005S62N Δ T□□□
68	$\pm 3\%$, $\pm 5\%$	8	100	0.80	1.1	1.50	0.87	200	MLG1005S68N Δ T□□□
75	$\pm 3\%$, $\pm 5\%$	8	100	0.75	1.1	1.50	0.93	200	MLG1005S75N Δ T□□□
82	$\pm 3\%$, $\pm 5\%$	8	100	0.70	1.0	1.60	1.01	200	MLG1005S82N Δ T□□□
91	$\pm 3\%$, $\pm 5\%$	8	100	0.70	0.9	1.80	1.14	200	MLG1005S91N Δ T□□□
100	$\pm 3\%$, $\pm 5\%$	8	100	0.70	0.9	2.00	1.37	200	MLG1005SR10 Δ T□□□
110	$\pm 3\%$, $\pm 5\%$	8	100	0.70	0.9	2.20	1.48	150	MLG1005SR11 Δ T□□□
120	$\pm 3\%$, $\pm 5\%$	8	100	0.60	0.8	2.20	1.48	150	MLG1005SR12 Δ T□□□
130	$\pm 3\%$, $\pm 5\%$	8	100	0.60	0.8	2.50	1.68	150	MLG1005SR13 Δ T□□□
150	$\pm 3\%$, $\pm 5\%$	8	100	0.55	0.7	3.50	2.44	150	MLG1005SR15 Δ T□□□
160	$\pm 3\%$, $\pm 5\%$	8	100	0.50	0.6	3.80	2.74	150	MLG1005SR16 Δ T□□□
180	$\pm 3\%$, $\pm 5\%$	8	100	0.50	0.6	3.80	2.88	150	MLG1005SR18 Δ T□□□
200	$\pm 3\%$, $\pm 5\%$	8	100	0.42	0.5	4.20	3.15	100	MLG1005SR20 Δ T□□□
220	$\pm 3\%$, $\pm 5\%$	8	100	0.45	0.5	4.20	3.02	100	MLG1005SR22 Δ T□□□
240	$\pm 3\%$, $\pm 5\%$	8	100	0.40	0.5	4.80	3.42	100	MLG1005SR24 Δ T□□□
270	$\pm 3\%$, $\pm 5\%$	8	100	0.40	0.5	4.80	3.54	100	MLG1005SR27 Δ T□□□
300	$\pm 3\%$, $\pm 5\%$	6	50	0.35	0.4	6.50	4.82	50	MLG1005SR30 Δ T□□□
330	$\pm 3\%$, $\pm 5\%$	6	50	0.35	0.4	7.00	5.21	50	MLG1005SR33 Δ T□□□
360	$\pm 3\%$, $\pm 5\%$	6	50	0.30	0.4	7.50	5.39	50	MLG1005SR36 Δ T□□□
390	$\pm 3\%$, $\pm 5\%$	6	50	0.30	0.4	8.00	5.97	50	MLG1005SR39 Δ T□□□

* The " Δ " of the Part Number contains the inductance tolerance code, B(± 0.1 nH), C(± 0.2 nH), S(± 0.3 nH), H($\pm 3\%$) or J($\pm 5\%$).
Please contact us for information on inductance tolerance, G ($\pm 2\%$).

* The "□□□" of the Part Number contains the internal code.

○ Measurement equipment

Measurement item	Product No.	Manufacturer
L, Q	4291B +16193A	Agilent Technologies
Self-resonant frequency	8720C	Agilent Technologies
DC resistance	Type-7561	Yokogawa

* Equivalent measurement equipment may be used.

MLGseries **MLG1005S Type**

■ ELECTRICAL CHARACTERISTICS

□ L, Q FREQUENCY CHARACTERISTICS TABLE

L(nH)typ.					Q typ.					Part No.*
500MHz	800MHz	1.8GHz	2.0GHz	2.4GHz	500MHz	800MHz	1.8GHz	2.0GHz	2.4GHz	
0.3	0.3	0.3	0.3	0.3	22min.	27min.	46min.	49min.	53min.	MLG1005S0N3 △ T □□□
0.4	0.4	0.4	0.4	0.4	22min.	27min.	46min.	49min.	53min.	MLG1005S0N4 △ T □□□
0.5	0.5	0.5	0.5	0.5	22min.	27min.	46min.	49min.	53min.	MLG1005S0N5 △ T □□□
0.6	0.6	0.6	0.6	0.6	22	27	46	49	53	MLG1005S0N6 △ T □□□
0.7	0.7	0.7	0.7	0.7	22	28	45	49	54	MLG1005S0N7 △ T □□□
0.8	0.8	0.8	0.8	0.8	26	34	57	60	66	MLG1005S0N8 △ T □□□
0.9	0.8	0.8	0.8	0.8	21	27	44	47	53	MLG1005S0N9 △ T □□□
0.9	0.9	0.9	0.9	0.9	22	29	48	50	56	MLG1005S1N0 △ T □□□
1.0	1.0	1.0	1.0	1.0	23	29	47	50	57	MLG1005S1N1 △ T □□□
1.1	1.1	1.1	1.1	1.1	23	29	48	50	56	MLG1005S1N2 △ T □□□
1.2	1.2	1.2	1.2	1.2	22	27	44	47	53	MLG1005S1N3 △ T □□□
1.4	1.4	1.4	1.5	1.5	23	29	47	50	56	MLG1005S1N5 △ T □□□
1.5	1.5	1.5	1.6	1.6	23	29	46	49	54	MLG1005S1N6 △ T □□□
1.7	1.7	1.7	1.7	1.7	20	26	41	43	49	MLG1005S1N8 △ T □□□
1.9	1.9	1.9	1.9	1.9	21	25	41	43	48	MLG1005S2N0 △ T □□□
2.1	2.1	2.1	2.1	2.2	22	27	44	47	52	MLG1005S2N2 △ T □□□
2.3	2.3	2.3	2.3	2.4	21	26	42	44	49	MLG1005S2N4 △ T □□□
2.6	2.6	2.6	2.7	2.7	22	27	43	45	50	MLG1005S2N7 △ T □□□
2.9	2.9	3.0	3.0	3.1	24	29	47	49	54	MLG1005S3N0 △ T □□□
3.2	3.2	3.3	3.4	3.5	24	30	46	48	53	MLG1005S3N3 △ T □□□
3.4	3.4	3.6	3.6	3.8	21	26	40	42	46	MLG1005S3N6 △ T □□□
3.7	3.7	3.9	3.9	4.1	22	28	43	45	50	MLG1005S3N9 △ T □□□
4.1	4.1	4.3	4.4	4.6	24	30	47	49	53	MLG1005S4N3 △ T □□□
4.5	4.5	4.8	4.9	5.2	23	30	45	47	50	MLG1005S4N7 △ T □□□
4.9	4.9	5.4	5.6	6.1	23	29	42	43	44	MLG1005S5N1 △ T □□□
5.4	5.4	5.8	5.9	6.3	22	28	42	43	45	MLG1005S5N6 △ T □□□
6.0	6.0	6.8	7.1	7.8	24	29	42	43	43	MLG1005S6N2 △ T □□□
6.5	6.6	7.4	7.8	8.6	23	28	40	41	41	MLG1005S6N8 △ T □□□
7.2	7.4	8.6	9.2	10.5	24	30	41	41	39	MLG1005S7N5 △ T □□□
7.9	8.0	9.3	9.9	11.3	23	28	38	38	36	MLG1005S8N2 △ T □□□
8.8	9.0	10.8	11.6	13.7	24	30	40	39	36	MLG1005S9N1 △ T □□□
9.7	9.9	12.4	13.5	16.7	24	30	37	36	31	MLG1005S10N △ T □□□
10.6	10.9	13.8	15.1	19.0	23	28	34	33	28	MLG1005S11N △ T □□□
11.7	12.1	16.2	18.3		23	29	33	31		MLG1005S12N △ T □□□
12.6	13.0	18.3	21.3		20	24	25	22		MLG1005S13N △ T □□□
14.7	15.3	22.0	26.0		23	28	29	26		MLG1005S15N △ T □□□
15.6	16.2	24.1	29.0		22	26	26	22		MLG1005S16N △ T □□□
17.7	18.6	29.0			23	28	26			MLG1005S18N △ T □□□
19.7	20.8	36.8			21	25	21			MLG1005S20N △ T □□□
21.8	23.3				22	27				MLG1005S22N △ T □□□
23.8	25.5				22	26				MLG1005S24N △ T □□□
27.0	29.6				20	23				MLG1005S27N △ T □□□
30.1	33.5				19	21				MLG1005S30N △ T □□□

* The "△" of the Part Number contains the inductance tolerance code, B(± 0.1 nH), C(± 0.2 nH), S(± 0.3 nH), H($\pm 3\%$) or J($\pm 5\%$). Please contact us for information on inductance tolerance, G ($\pm 2\%$).

* The "□□□" of the Part Number contains the internal code.

○ Measurement equipment

Product No.	Manufacturer
4291B +16193A	Agilent Technologies

* Equivalent measurement equipment may be used.

MLG_{series} **MLG1005S Type**

■ ELECTRICAL CHARACTERISTICS

□ L, Q FREQUENCY CHARACTERISTICS TABLE

L(nH)typ.					Q typ.					Part No.*
500MHz	800MHz	1.8GHz	2.0GHz	2.4GHz	500MHz	800MHz	1.8GHz	2.0GHz	2.4GHz	
33.5	37.8				20	23				MLG1005S33N △ T □□□
36.7	41.5				21	23				MLG1005S36N △ T □□□
40.3	46.9				20	21				MLG1005S39N △ T □□□
44.3	51.6				20	21				MLG1005S43N △ T □□□
50.2	63.2				19	20				MLG1005S47N △ T □□□
53.7	65.6				19	19				MLG1005S51N △ T □□□
60.9	80.2				19	18				MLG1005S56N △ T □□□
67.5	89.8				18	16				MLG1005S62N △ T □□□
75.8	107.5				17	15				MLG1005S68N △ T □□□
86.5	135.2				17	13				MLG1005S75N △ T □□□
96.9					16					MLG1005S82N △ T □□□
111.0					15					MLG1005S91N △ T □□□
128.9					14					MLG1005SR10 △ T □□□
140.8					15					MLG1005SR11 △ T □□□
175.2					12					MLG1005SR12 △ T □□□
187.8					13					MLG1005SR13 △ T □□□
284.7					11					MLG1005SR15 △ T □□□
										MLG1005SR16 △ T □□□
										MLG1005SR18 △ T □□□
										MLG1005SR20 △ T □□□
										MLG1005SR22 △ T □□□
										MLG1005SR24 △ T □□□
										MLG1005SR27 △ T □□□
										MLG1005SR30 △ T □□□
										MLG1005SR33 △ T □□□
										MLG1005SR36 △ T □□□
										MLG1005SR39 △ T □□□

* The "△" of the Part Number contains the inductance tolerance code, B(± 0.1 nH), C(± 0.2 nH), S(± 0.3 nH), H($\pm 3\%$) or J($\pm 5\%$). Please contact us for information on inductance tolerance, G ($\pm 2\%$).

* The "□□□" of the Part Number contains the internal code.

○ Measurement equipment

Product No.	Manufacturer
4291B +16193A	Agilent Technologies

* Equivalent measurement equipment may be used.

MLGseries **MLG1005S Type**

■ ELECTRICAL CHARACTERISTICS

□ L FREQUENCY CHARACTERISTICS GRAPH (EXAMPLE)

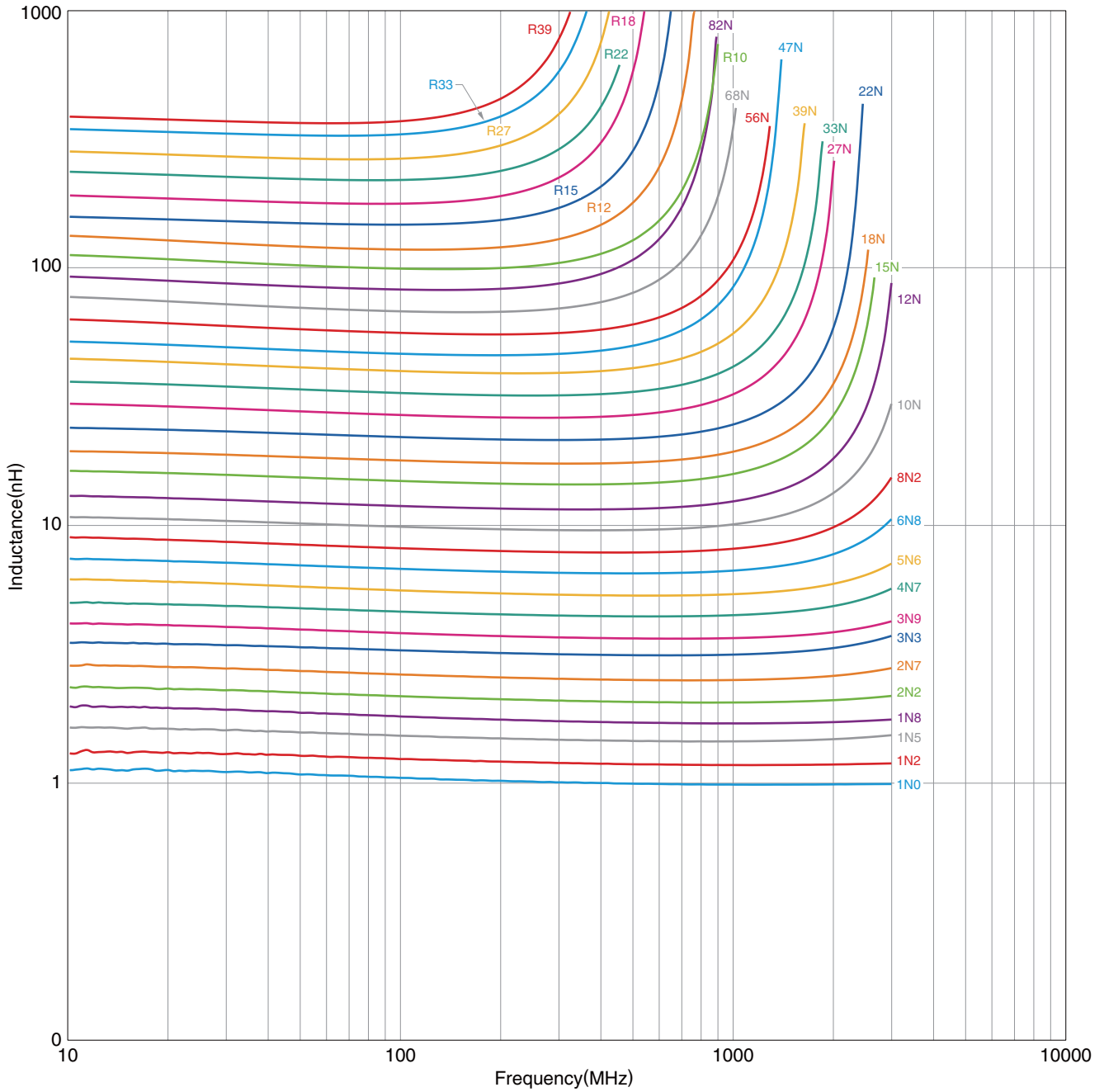

○ Measurement equipment

Product No.	Manufacturer
E4991A +16193A	Agilent Technologies

* Equivalent measurement equipment may be used.

• All specifications are subject to change without notice.

MLGseries **MLG1005S Type**

■ ELECTRICAL CHARACTERISTICS

□ Q FREQUENCY CHARACTERISTICS GRAPH (EXAMPLE)

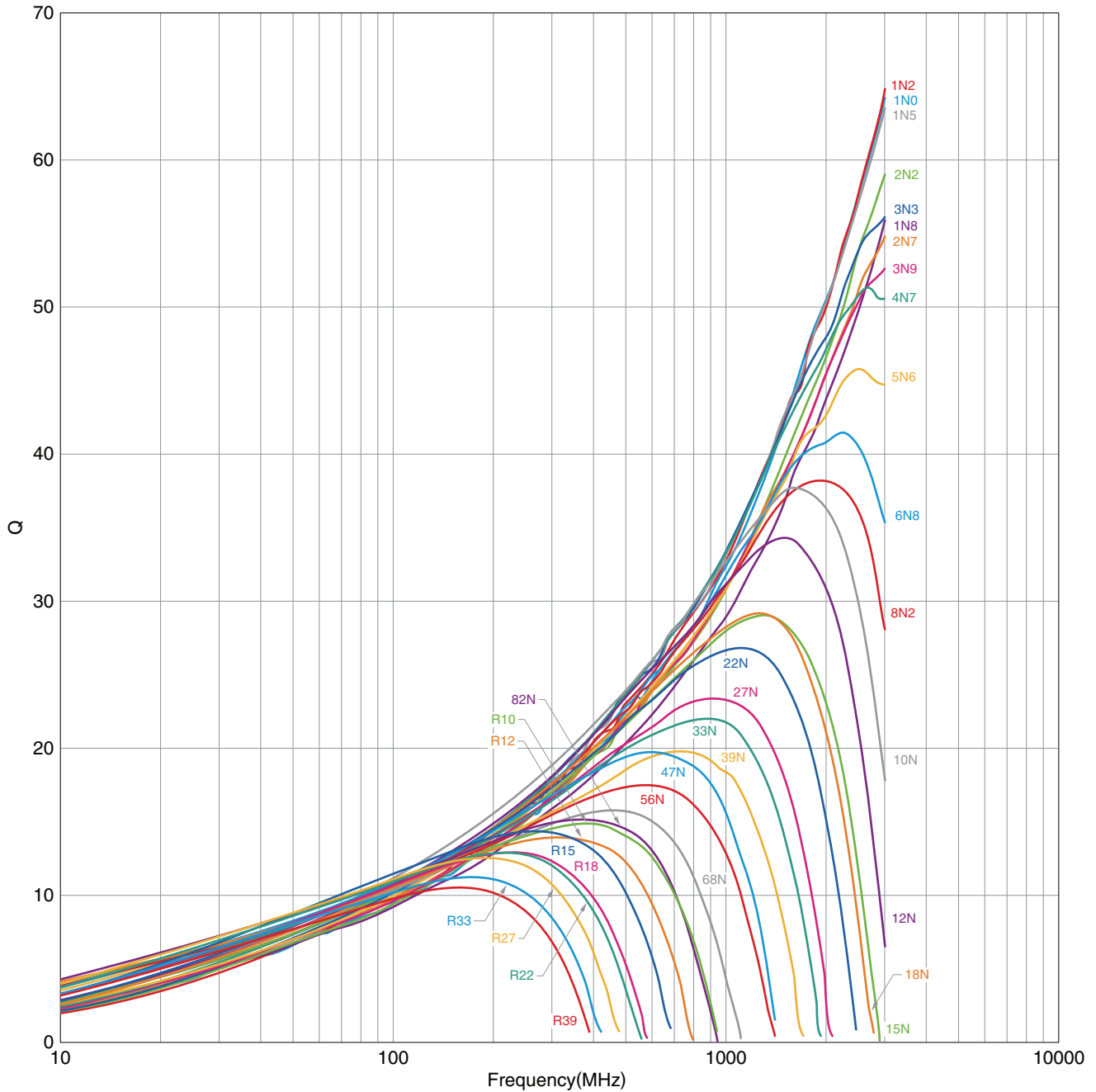

○ Measurement equipment

Product No.	Manufacturer
E4991A +16193A	Agilent Technologies

* Equivalent measurement equipment may be used.

• All specifications are subject to change without notice.

MLGseries

MLG1608Type



■ SHAPE & DIMENSIONS

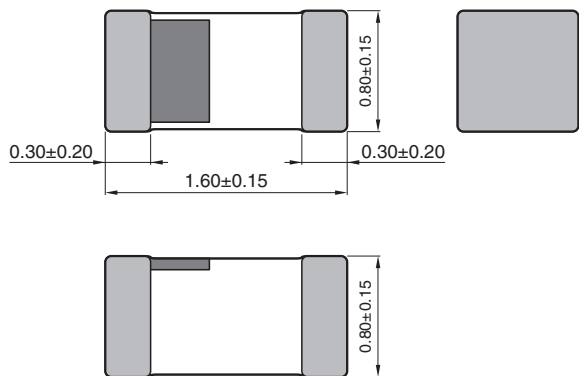

Dimensions in mm

■ RECOMMENDED LAND PATTERN

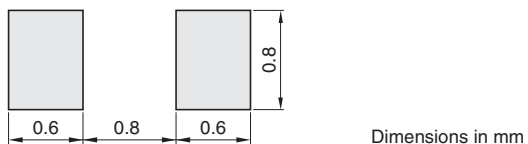

Dimensions in mm

• All specifications are subject to change without notice.

MLGseries **MLG1608 Type**

■ ELECTRICAL CHARACTERISTICS

□ CHARACTERISTICS SPECIFICATION TABLE

L (nH)	Tolerance	Q min.	L, Q measuring frequency (MHz)	Self-resonant frequency (GHz)		DC resistance (Ω)		Rated current (mA) max.	Part No.*
				min.	typ.	max.	typ.		
1	$\pm 0.3\text{nH}$	8	100	10.0	20up	0.10	0.03	600	MLG1608B1N0ST□□□
1.2	$\pm 0.3\text{nH}$	8	100	10.0	20up	0.10	0.04	600	MLG1608B1N2ST□□□
1.5	$\pm 0.3\text{nH}$	8	100	10.0	19.6	0.10	0.03	600	MLG1608B1N5ST□□□
1.8	$\pm 0.3\text{nH}$	8	100	10.0	16.6	0.10	0.04	600	MLG1608B1N8ST□□□
2.2	$\pm 0.3\text{nH}$	10	100	8.0	10.8	0.10	0.05	600	MLG1608B2N2ST□□□
2.7	$\pm 0.3\text{nH}$	10	100	7.0	8.8	0.12	0.06	600	MLG1608B2N7ST□□□
3.3	$\pm 0.3\text{nH}$	10	100	6.5	8.8	0.12	0.06	600	MLG1608B3N3ST□□□
3.9	$\pm 0.3\text{nH}$	10	100	6.0	7.9	0.14	0.06	600	MLG1608B3N9ST□□□
4.7	$\pm 0.3\text{nH}$	10	100	5.0	6.8	0.15	0.08	600	MLG1608B4N7ST□□□
5.6	$\pm 0.5\text{nH}$	10	100	5.0	6.8	0.16	0.08	600	MLG1608B5N6DT□□□
6.8	$\pm 0.5\text{nH}$	10	100	4.5	5.7	0.18	0.10	600	MLG1608B6N8DT□□□
8.2	$\pm 0.5\text{nH}$	10	100	4.5	5.6	0.20	0.10	600	MLG1608B8N2DT□□□
10	$\pm 5\%$	12	100	3.5	4.5	0.20	0.11	600	MLG1608B10NJT□□□
12	$\pm 5\%$	12	100	3.0	3.8	0.25	0.13	600	MLG1608B12NJT□□□
15	$\pm 5\%$	12	100	2.8	3.6	0.28	0.14	600	MLG1608B15NJT□□□
18	$\pm 5\%$	12	100	2.6	3.3	0.32	0.16	600	MLG1608B18NJT□□□
22	$\pm 5\%$	12	100	2.3	3.0	0.35	0.19	500	MLG1608B22NJT□□□
27	$\pm 5\%$	12	100	2.0	2.7	0.40	0.21	500	MLG1608B27NJT□□□
33	$\pm 5\%$	12	100	1.8	2.3	0.50	0.25	500	MLG1608B33NJT□□□
39	$\pm 5\%$	12	100	1.6	2.0	0.55	0.26	400	MLG1608B39NJT□□□
47	$\pm 5\%$	14	100	1.4	1.8	0.60	0.35	400	MLG1608B47NJT□□□
56	$\pm 5\%$	14	100	1.2	1.8	0.70	0.41	400	MLG1608B56NJT□□□
68	$\pm 5\%$	14	100	1.1	1.6	0.75	0.43	300	MLG1608B68NJT□□□
82	$\pm 5\%$	14	100	1.0	1.4	0.80	0.50	300	MLG1608B82NJT□□□
100	$\pm 5\%$	14	100	0.80	1.2	1.00	0.64	300	MLG1608BR10JT□□□
120	$\pm 5\%$	14	100	0.65	0.8	1.20	0.89	300	MLG1608SR12JT□□□
150	$\pm 5\%$	14	100	0.55	0.7	1.30	1.03	250	MLG1608SR15JT□□□
180	$\pm 5\%$	14	100	0.50	0.6	1.40	1.08	250	MLG1608SR18JT□□□
220	$\pm 5\%$	14	100	0.45	0.6	1.70	1.29	200	MLG1608SR22JT□□□
270	$\pm 5\%$	14	100	0.35	0.5	2.00	1.59	200	MLG1608SR27JT□□□
330	$\pm 5\%$	10	50	0.35	0.47	2.80	1.90	100	MLG1608SR33JT□□□
390	$\pm 5\%$	10	50	0.30	0.43	3.00	2.06	100	MLG1608SR39JT□□□
470	$\pm 5\%$	10	50	0.25	0.39	3.50	2.47	100	MLG1608SR47JT□□□
560	$\pm 5\%$	10	50	0.25	0.36	4.50	3.20	70	MLG1608SR56JT□□□
680	$\pm 5\%$	10	50	0.20	0.31	5.50	3.88	70	MLG1608SR68JT□□□
820	$\pm 5\%$	10	50	0.15	0.22	5.50	3.76	70	MLG1608SR82JT□□□
1000	$\pm 5\%$	10	50	0.13	0.19	5.50	4.27	70	MLG1608S1R0JT□□□

* The "□□□" of the Part Number contains the internal code.
Because it provides for a product of smaller inductance tolerance, please refer.

○ Measurement equipment

Measurement item	Product No.	Manufacturer
L, Q	4291B +16193A	Agilent Technologies
Self-resonant frequency	8720C	Panasonic
DC resistance	Type-7561	Yokogawa

* Equivalent measurement equipment may be used.

MLGseries **MLG1608 Type**

■ ELECTRICAL CHARACTERISTICS

□ L, Q FREQUENCY CHARACTERISTICS TABLE

L(nH)typ.					Q typ.					Part No.*
500MHz	800MHz	1.8GHz	2.0GHz	2.4GHz	500MHz	800MHz	1.8GHz	2.0GHz	2.4GHz	
1.0	1.0	1.0	1.0	1.0	39	48	77	82	95	MLG1608B1N0ST□□□
1.2	1.1	1.2	1.2	1.2	28	35	57	60	68	MLG1608B1N2ST□□□
1.5	1.5	1.5	1.5	1.5	37	48	78	81	93	MLG1608B1N5ST□□□
1.8	1.8	1.8	1.8	1.8	38	48	77	81	95	MLG1608B1N8ST□□□
2.2	2.1	2.2	2.2	2.2	44	54	88	91	107	MLG1608B2N2ST□□□
2.6	2.6	2.7	2.7	2.8	40	51	79	81	94	MLG1608B2N7ST□□□
3.2	3.2	3.3	3.3	3.4	38	48	76	79	91	MLG1608B3N3ST□□□
3.8	3.8	4.0	4.0	4.1	40	50	79	81	93	MLG1608B3N9ST□□□
4.6	4.6	4.9	5.0	5.2	41	51	76	79	88	MLG1608B4N7ST□□□
5.4	5.5	5.8	5.9	6.2	37	46	69	71	79	MLG1608B5N6DT□□□
6.6	6.7	7.3	7.5	8.0	38	47	67	68	74	MLG1608B6N8DT□□□
8.0	8.1	8.9	9.3	10	39	48	67	68	71	MLG1608B8N2DT□□□
9.8	10.0	11.5	12.1	13.6	38	47	63	63	61	MLG1608B10NJT□□□
11.8	12.1	14.8	16.0	19.3	39	48	59	57	51	MLG1608B12NJT□□□
14.8	15.4	20.6	23.4		38	46	49	46		MLG1608B15NJT□□□
17.8	18.5	25.5	29.3		36	44	47	42		MLG1608B18NJT□□□
21.9	22.9	33.6	40.2		36	44	43	38		MLG1608B22NJT□□□
27.1	28.8	50.6			37	43	34			MLG1608B27NJT□□□
33.4	36.0				37	43				MLG1608B33NJT□□□
40.2	45.0				36	40				MLG1608B39NJT□□□
49.1	56.0				38	41				MLG1608B47NJT□□□
59.6	71.1				37	38				MLG1608B56NJT□□□
74.0	92.8				34	33				MLG1608B68NJT□□□
91.1	120.6				33	31				MLG1608B82NJT□□□
118					35					MLG1608BR10JT□□□
188					23					MLG1608SR12JT□□□
										MLG1608SR15JT□□□
										MLG1608SR18JT□□□
										MLG1608SR22JT□□□
										MLG1608SR27JT□□□
										MLG1608SR33JT□□□
										MLG1608SR39JT□□□
										MLG1608SR47JT□□□
										MLG1608SR56JT□□□
										MLG1608SR68JT□□□
										MLG1608SR82JT□□□
										MLG1608SR1R0JT□□□

* The "□□□" of the Part Number contains the internal code.
Because it provides for a product of smaller inductance tolerance, please refer.

○ Measurement equipment

Product No.	Manufacturer
4291B +16193A	Agilent Technologies

* Equivalent measurement equipment may be used.

MLGseries MLG1608Type

ELECTRICAL CHARACTERISTICS

L FREQUENCY CHARACTERISTICS GRAPH (EXAMPLE)

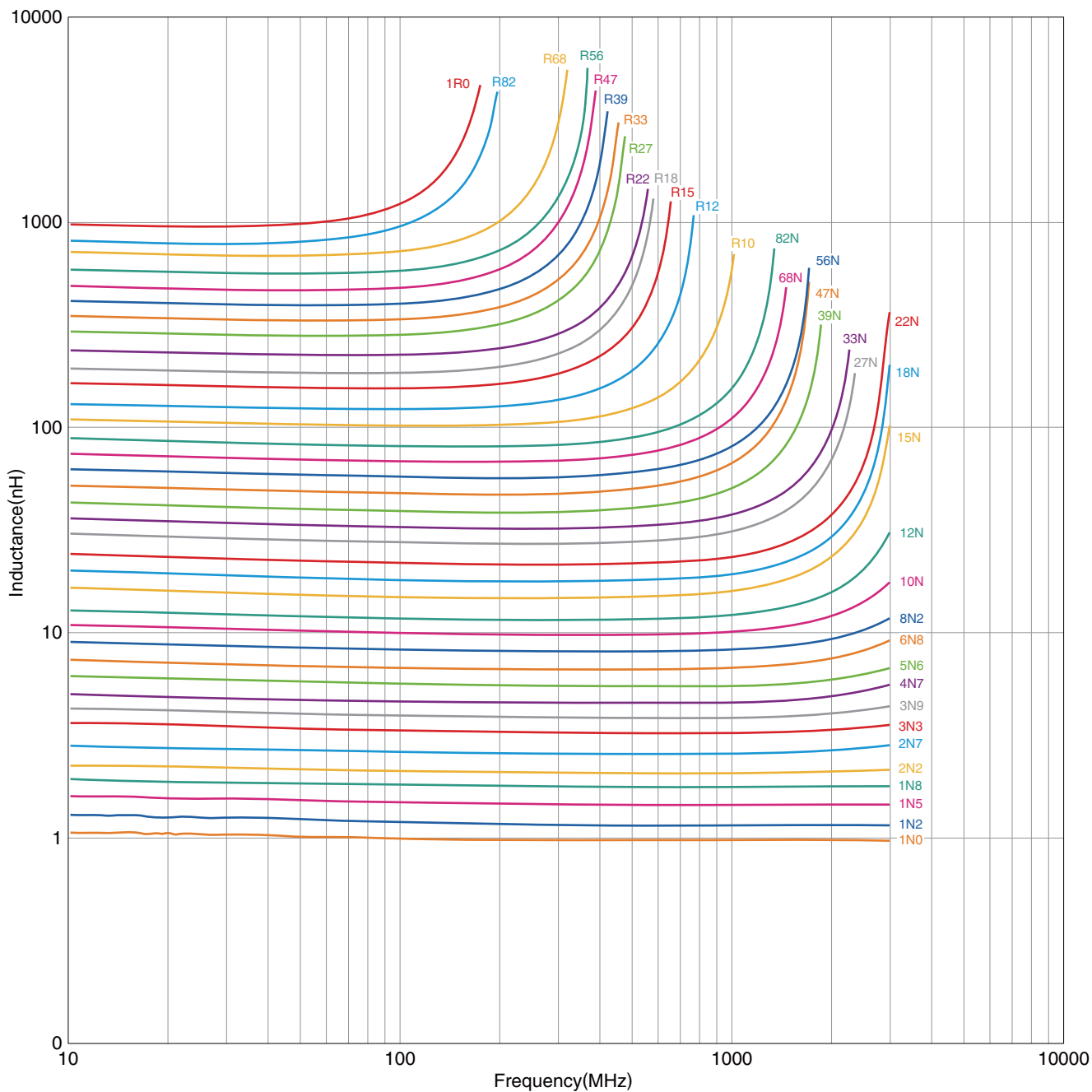

○ Measurement equipment

Product No.	Manufacturer
E4991A +16193A	Agilent Technologies

* Equivalent measurement equipment may be used.

• All specifications are subject to change without notice.

MLGseries MLG1608Type

ELECTRICAL CHARACTERISTICS

Q FREQUENCY CHARACTERISTICS GRAPH (EXAMPLE)

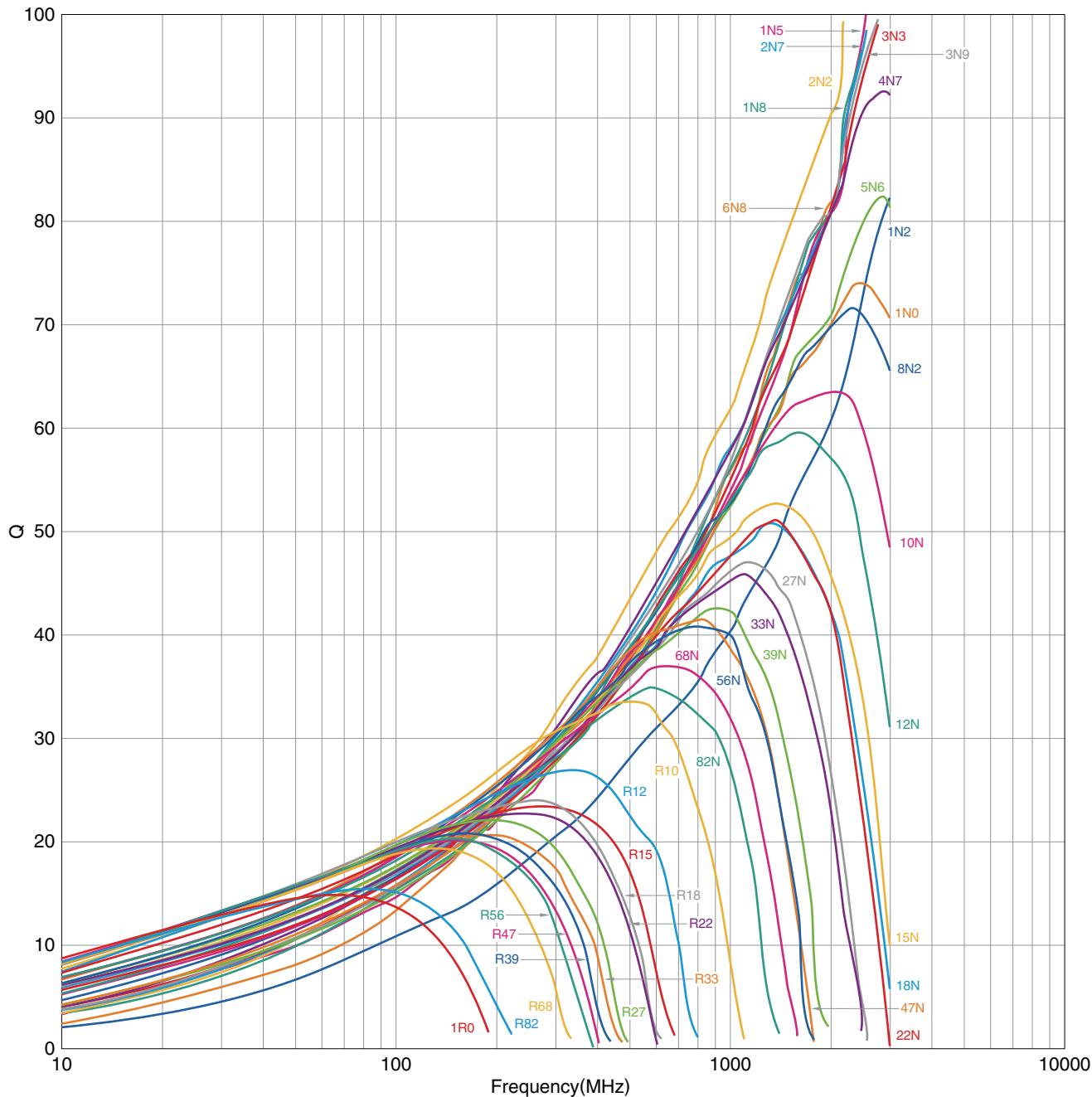

○ Measurement equipment

Product No.	Manufacturer
E4991A +16193A	Agilent Technologies

* Equivalent measurement equipment may be used.

• All specifications are subject to change without notice.

MLGseries

Packaging Style

REEL DIMENSIONS

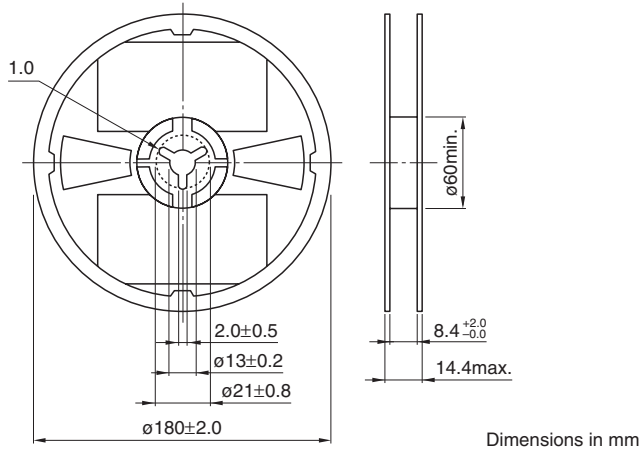

TAPE DIMENSIONS

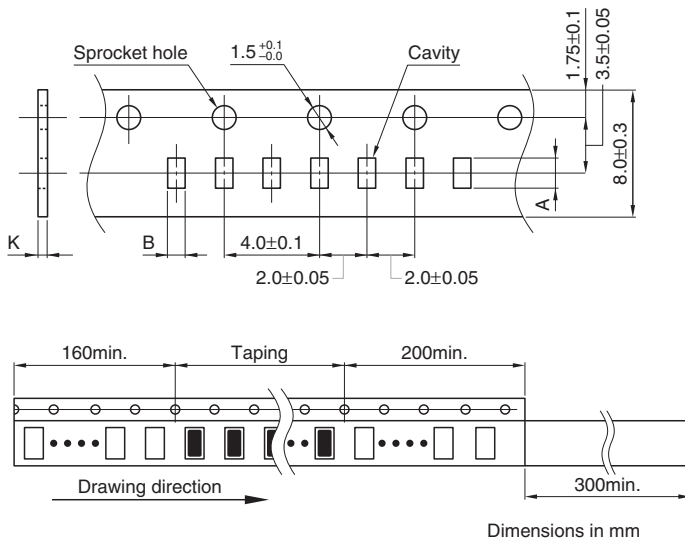

Type	A	B	K
MLG0603S	0.68±0.05	0.38±0.05	0.5 max.
MLG1005S	1.12±0.1	0.62±0.1	0.8 max.
MLG1608	1.9±0.2	1.1±0.2	1.1 max.

• All specifications are subject to change without notice.

Mouser Electronics

Authorized Distributor

Click to View Pricing, Inventory, Delivery & Lifecycle Information:

[TDK:](#)

[MLG1005S6N2S](#)