

SPECIFICATION

Part No.	: FXP831.07.0100C
Product Name	: FXP.831 Freedom 2.4/4.9-6GHz Ground Coupled Antenna
Feature	: Flexible Ultra Low Profile 45mm*7mm*0.1mm Adheres directly to inside of product plastic or glass housing Form factor and cable routing convenient for integration High Efficiency IPEX MHF Connector (U.FL compatible) 100m 1.37mm co-axial cable RoHS Compliant



1. Introduction

The FXP831 is a high efficiency, small, dual-band, dipole antenna for 2.4/4.9-6GHz band including WiFi, Bluetooth, Zigbee, DSRC, V2V, and other applications in these bands. The FXP.831 has a peak gain of 2.5dBi at 2.4GHz and efficiencies of 56%, and 4.5dBi and 55% along bands 4.9GHz to 6GHz.

This Taoglas patent pending antenna is unique in the market because it is made from poly-flexible material, has a tiny form factor (45*7*.01mm) and has double-sided 3M tape for easy "peel and stick" mounting.

The cable routes conveniently directly out of the bottom of the antenna, reducing the volume the antenna takes up in the device to an absolute minimum compared to other designs. The FXP.831 is the ideal all-round antenna solution for squeezing into narrow spaces and still maintaining high performance, for example on the inside top or adjacent side applied directly to the plastic housing of LCD devices.

Many module manufacturers specify peak gain limits for any antennas that are to be connected to that module. Those peak gain limits are based on free-space conditions. In practice, the peak gain of an antenna tested in free-space can degrade by at least 1 or 2dBi when put inside a device. So ideally you should go for a slightly higher peak gain antenna than mentioned on the module specification to compensate for this effect, giving you better performance.

Upon testing of any of our antennas with your device and a selection of appropriate layout, integration technique, or cable, Taoglas can make sure any of our antennas' peak gain will be below the peak gain limits. Taoglas can then issue a specification and/or report for the selected antenna in your device that will clearly show it complying with the peak gain limits, so you can be assured you are meeting regulatory requirements for that module.

For example, a module manufacturer may state that the antenna must have less than 2dBi peak gain, but you don't need to select an embedded antenna that has a peak gain of less than 2dBi in free-space. This will give you a less optimized solution. It is better to go for a slightly higher free-space peak gain of 3dBi or more if available. Once



that antenna gets integrated into your device, performance will degrade below this 2dBi peak gain due to the effects of GND plane, surrounding components, and device housing. If you want to be absolutely sure, contact Taoglas and we will test. Choosing a Taoglas antenna with a higher peak gain than what is specified by the module manufacturer and enlisting our help will ensure you are getting the best performance possible without exceeding the peak gain limits.

2. Specification

ELECTRICAL		
Frequency	2.4 ~ 2.5GHz,	4.9 ~ 6.0GHz
Peak Gain (free space)	2.5dBi	4.5dBi
Peak Gain (on plastic*)	3.0dBi	5.5dBi
Average Gain (free space)	-2.6dBi	-2.6dBi
Average Gain (on plastic)	-2.6dBi	-1.8dBi
Efficiency (free space)	56%	55%
Efficiency (on plastic)	56%	75%
VSWR	≤2.5 : 1	
Impedance	50 Ohms	
Polarization	Linear	
Radiation Pattern	Omni	
Input Power	2W max.	
MECHANICAL		
Dimensions	45mm x 7mm	
Antenna Body Material	Polymer	
Cable	Gray 100mm 1.37 co-axial	
Connector	IPEX MHFHT(U.FL comp)	
ENVIRONMENTAL		
Temperature Range	-40°C to 85°C	
Humidity	Non-condensing 65°C 95% RH	

3. Electrical Characteristic

3.1 S11

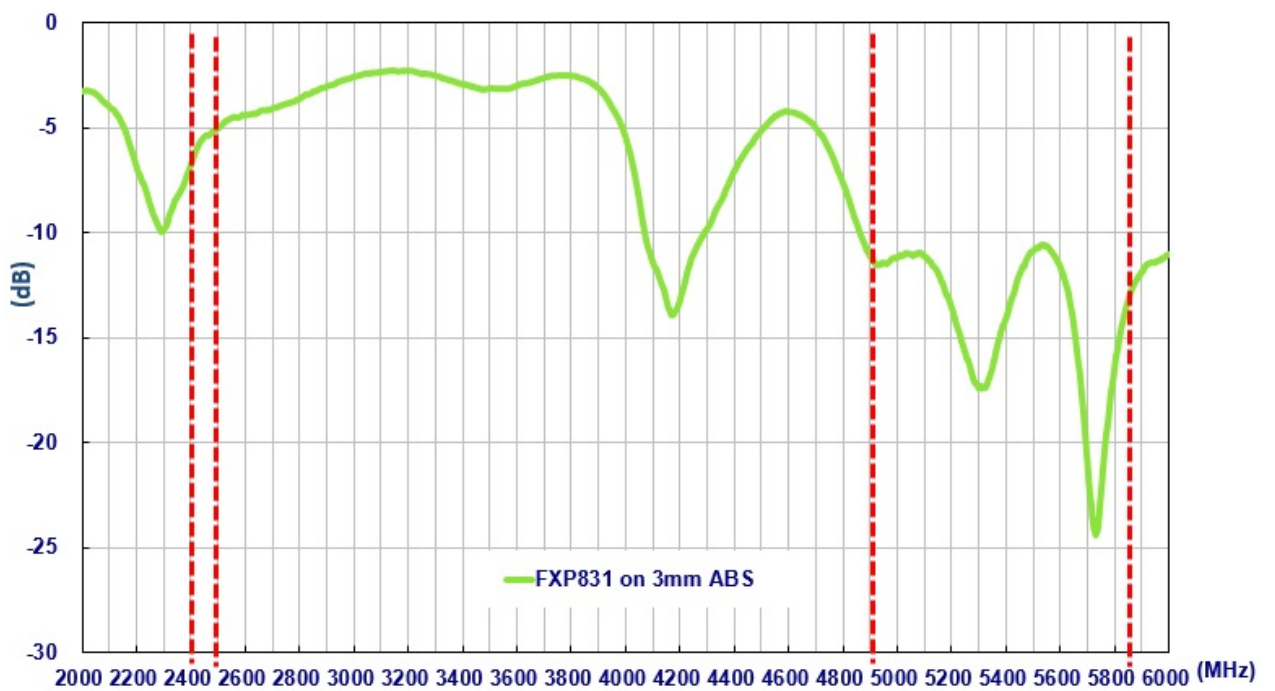
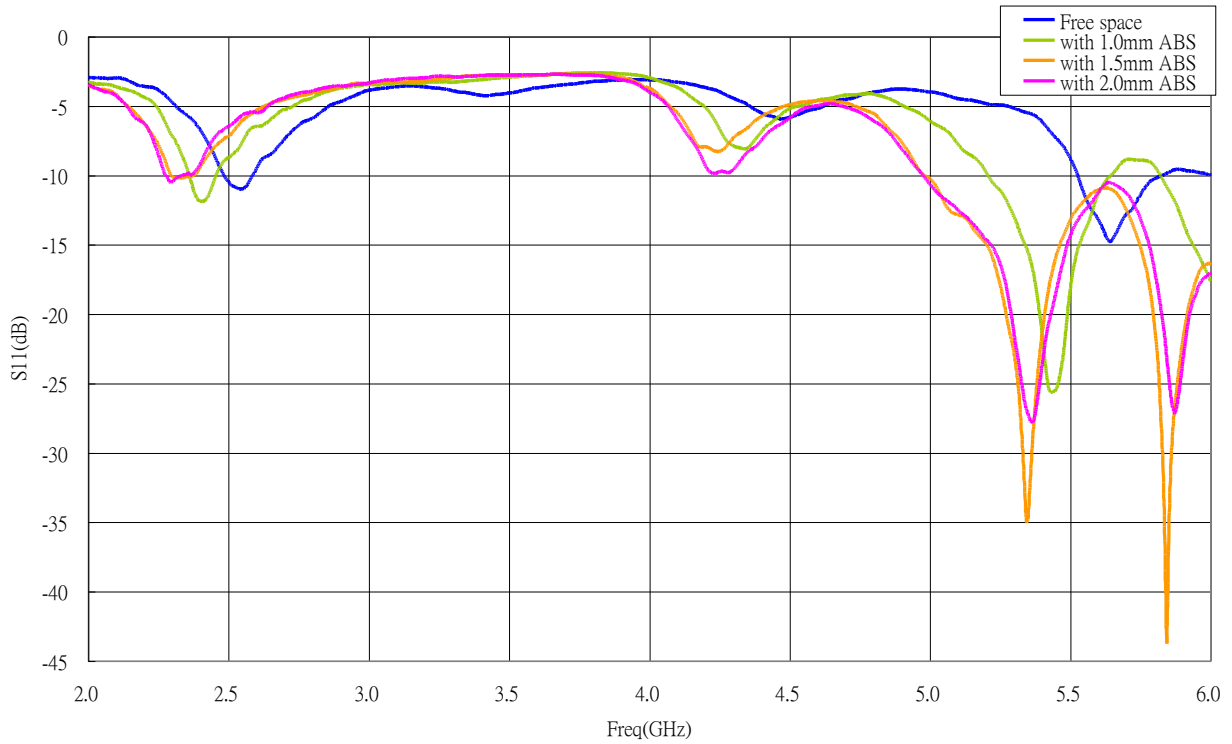

3.2 Test Setup

A ETS AMS-8500 test chamber is used for the free space radiation testing for FXP831.07.0100A. The measurement is taken with the antenna properly mounted in the designated device

Device tested in AMS-8500 Rectangular test chamber.

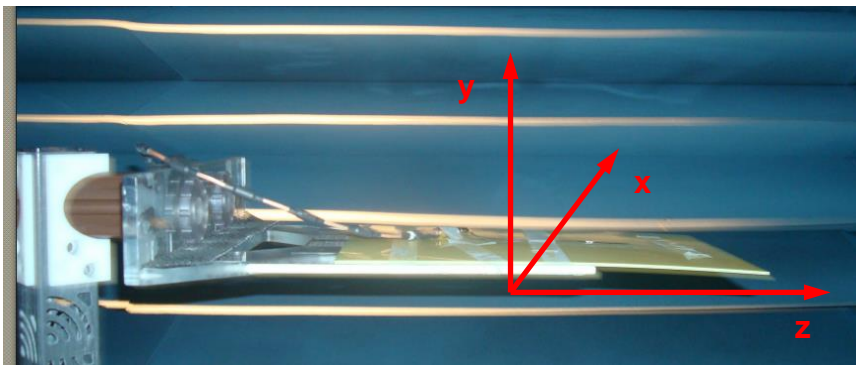

FXP831 on Baxter device to indicate the testing coordinate

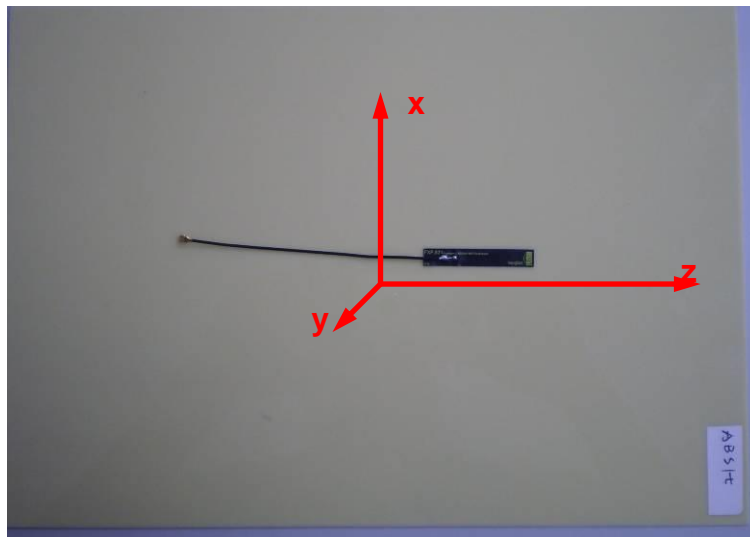

FXP831 on Baxter device to indicate the testing coordinate

3.3 Radiation Pattern

3.3.1 XZ plane (at 2400MHz)

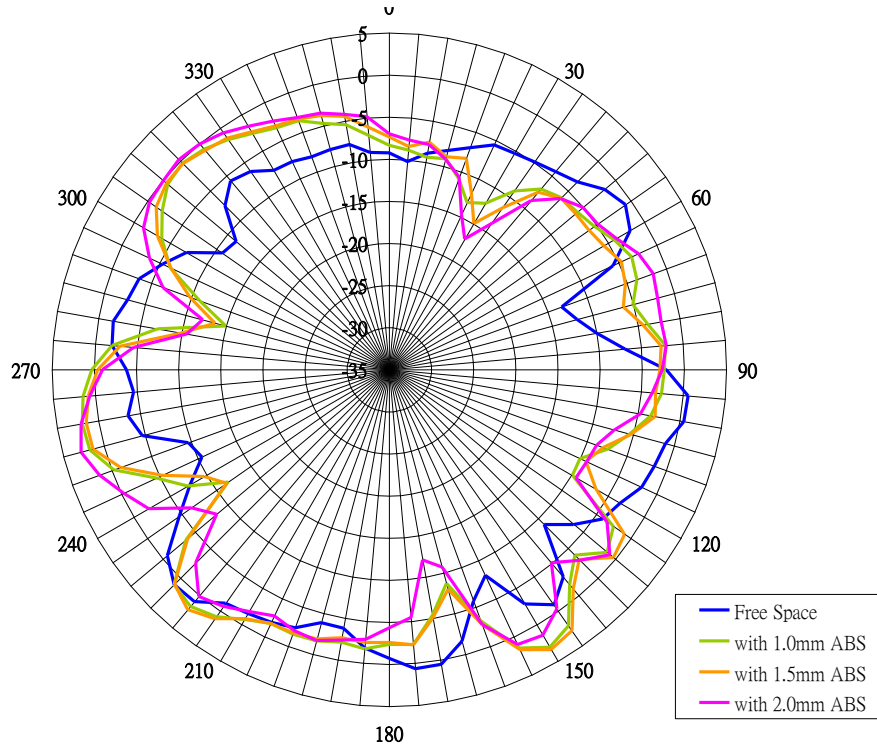

3.3.2 XZ plane (at 2500MHz)

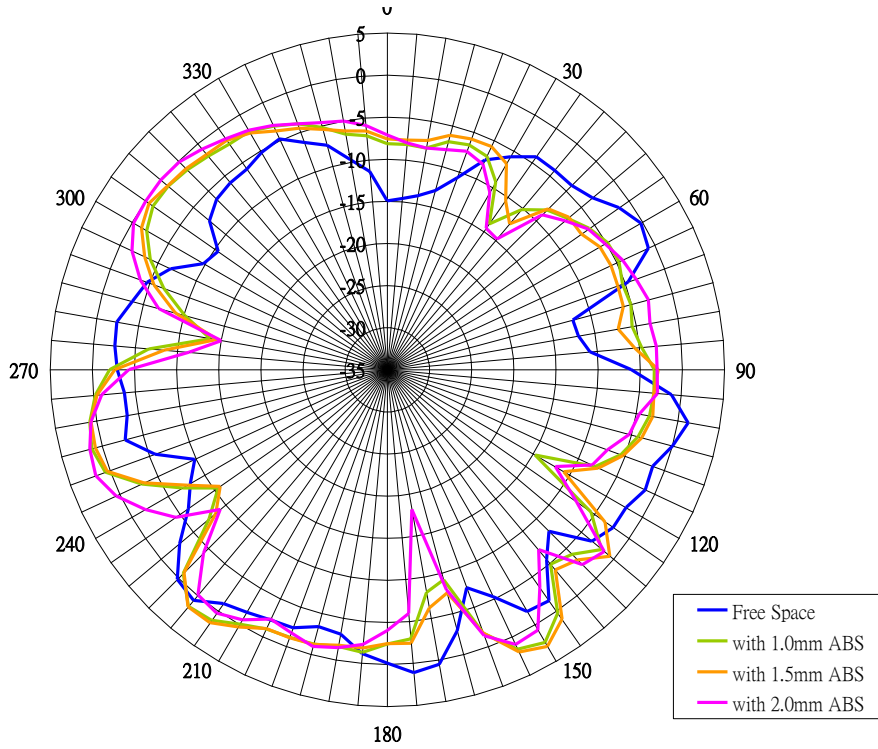

3.3.3 XZ plane (at 5000MHz)

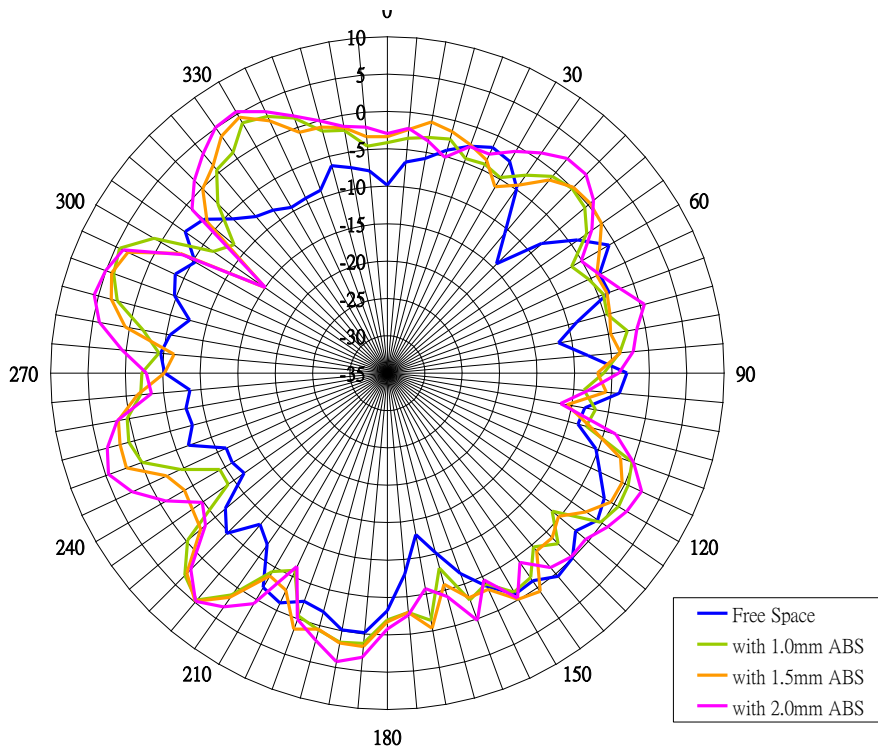

3.3.4 XZ plane (at 5500MHz)

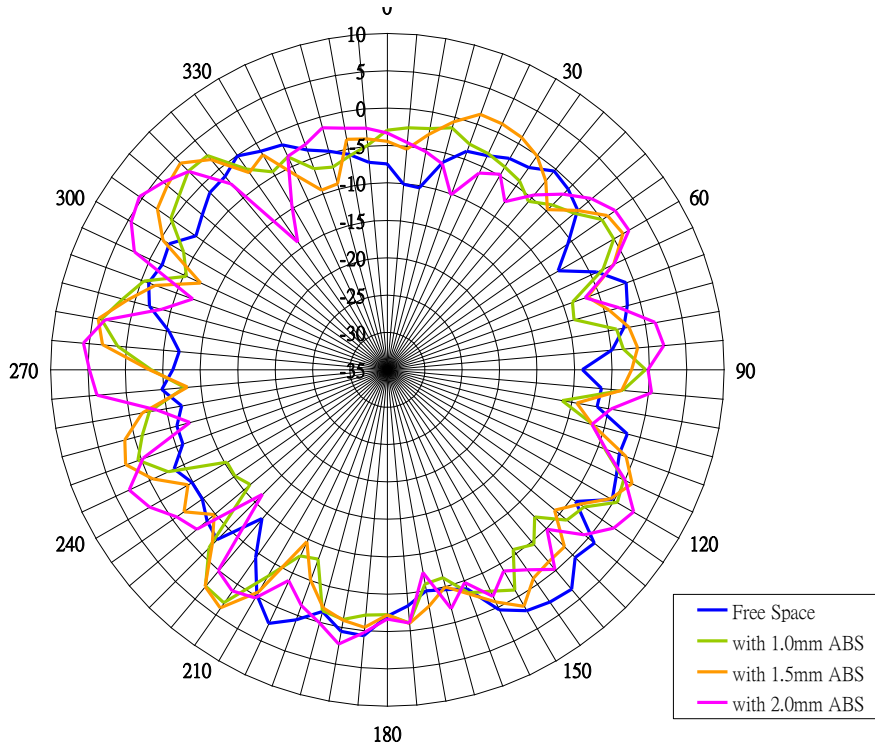

3.3.5 XZ plane (at 6000MHz)

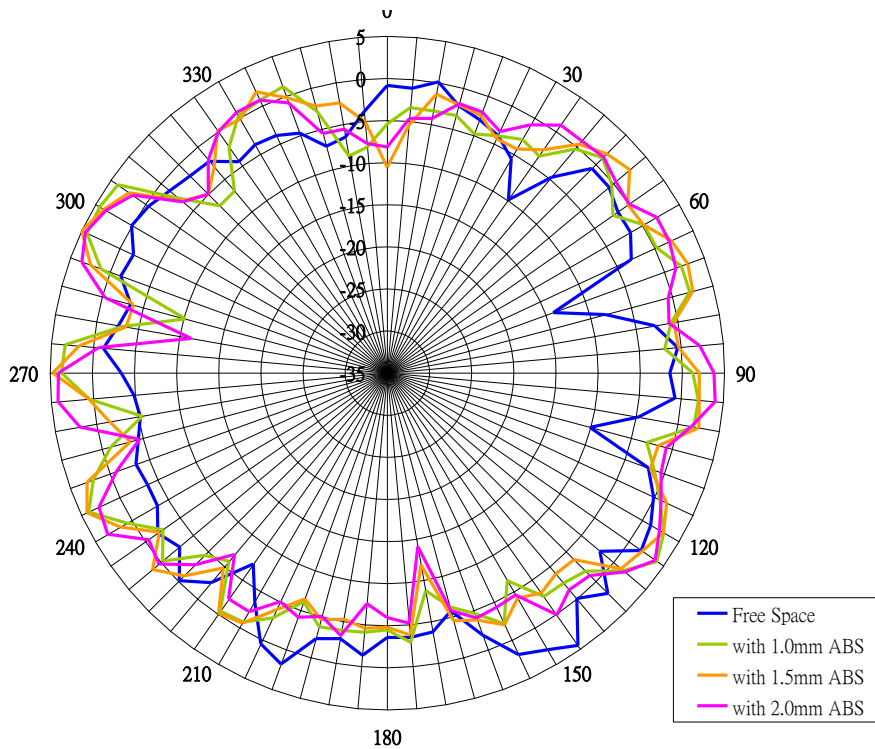

3.3.6 YZ plane (at 2400MHz)

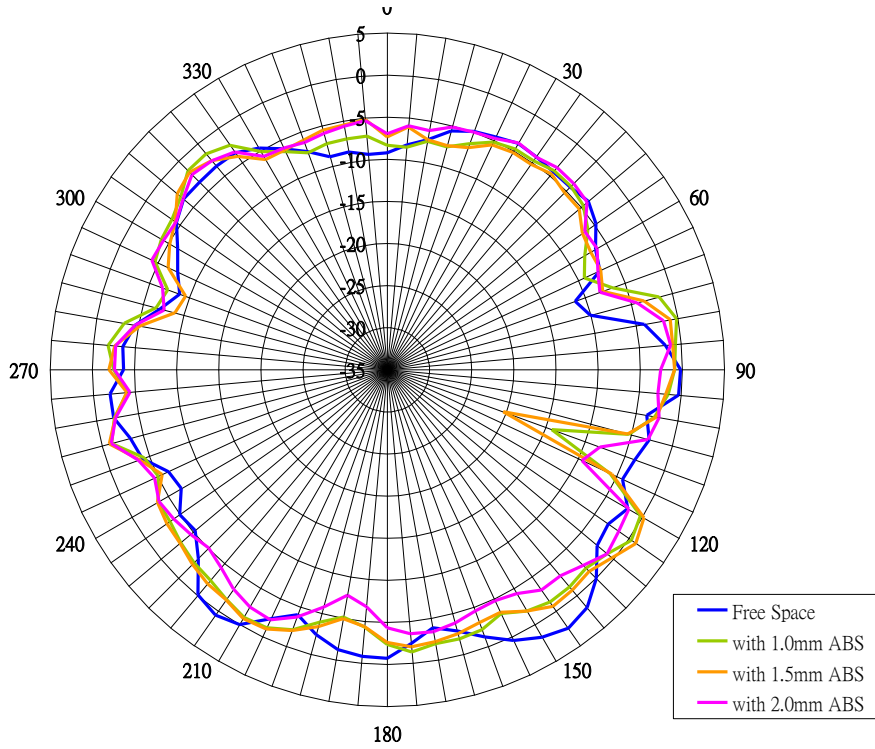

3.3.7 YZ plane (at 2500MHz)

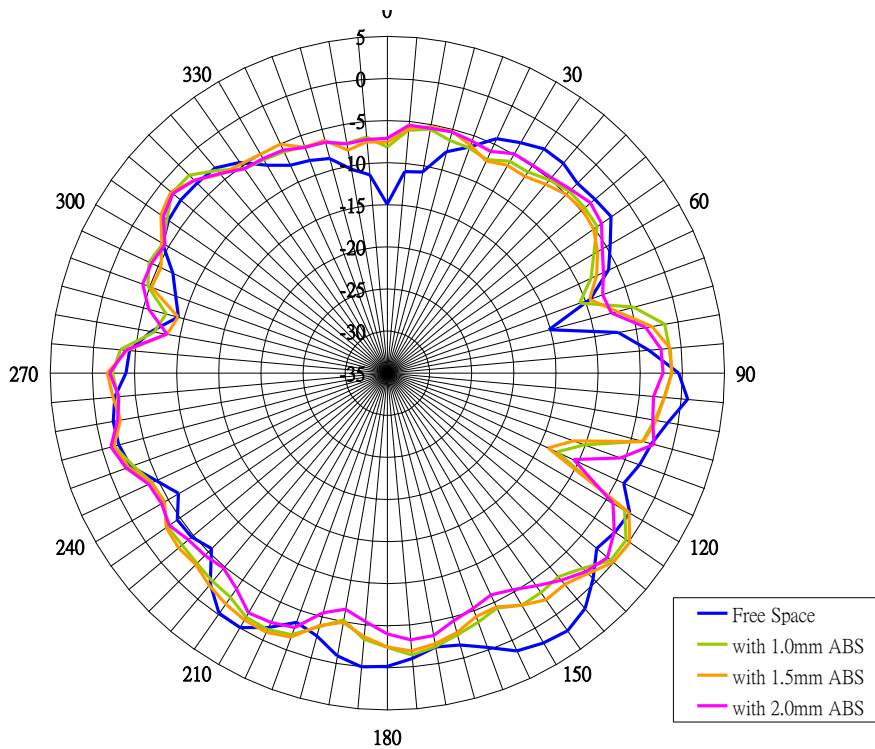

3.3.8 YZ plane (at 5000MHz)

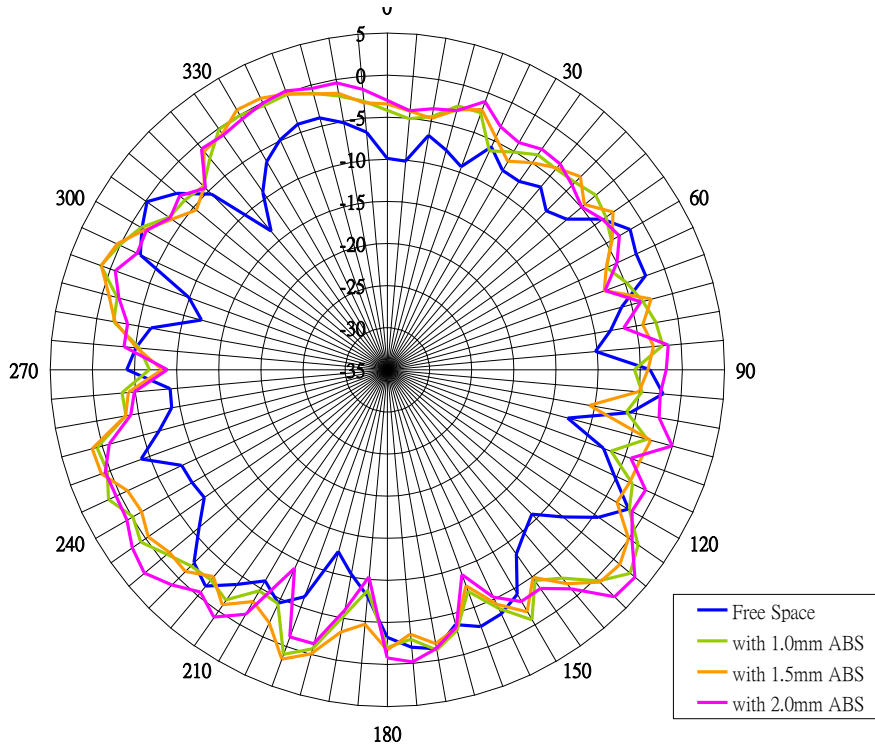

3.3.9 YZ plane (at 5500MHz)

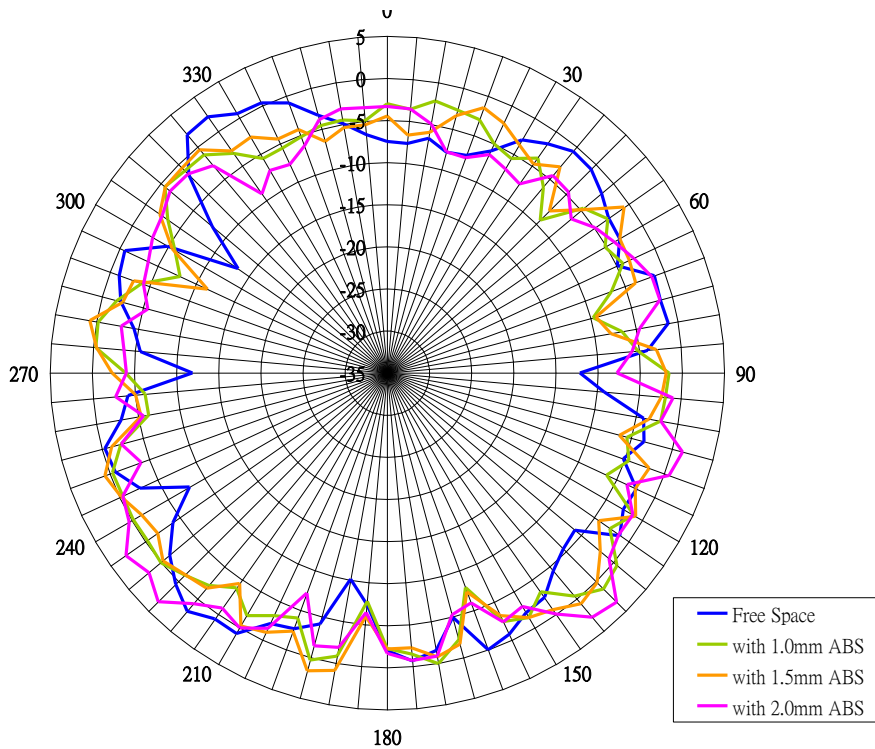

3.3.10 YZ plane (at 6000MHz)

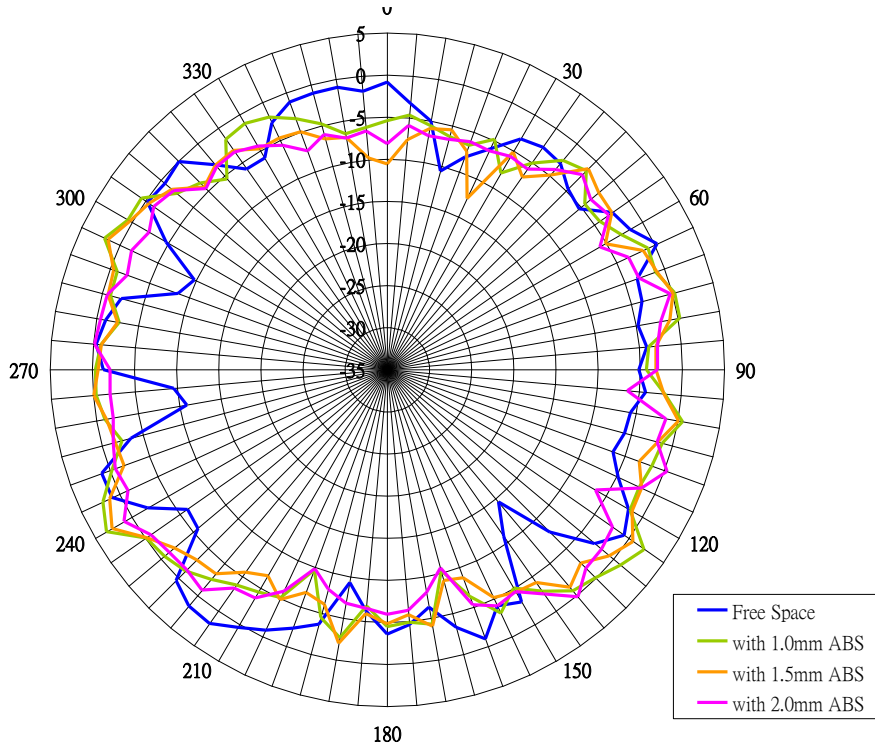

3.3.11 XY plane (at 2400MHz)

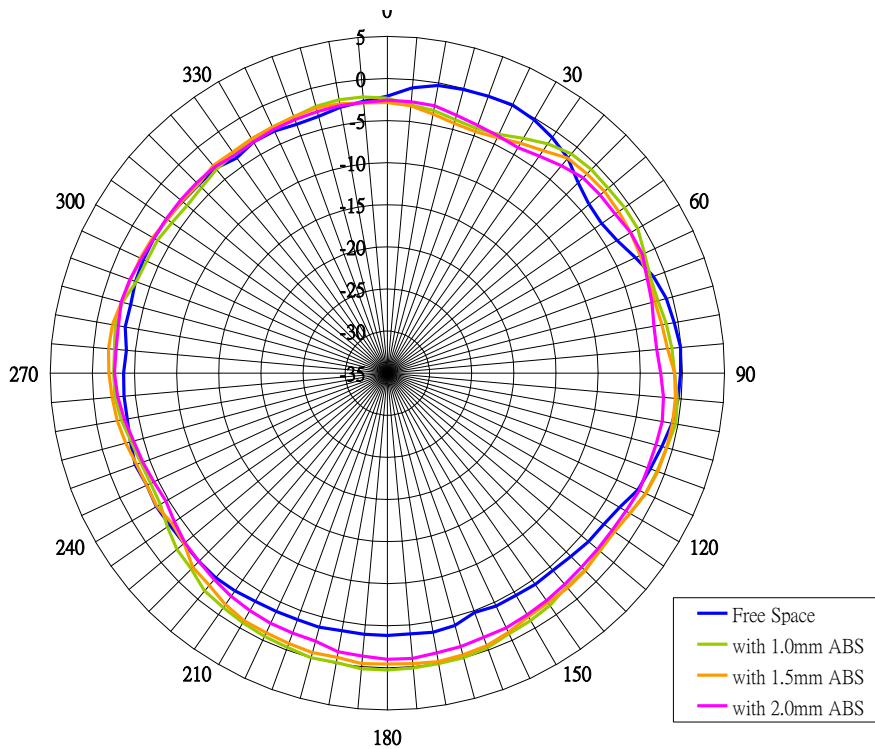

3.3.12 XY plane (at 2500MHz)

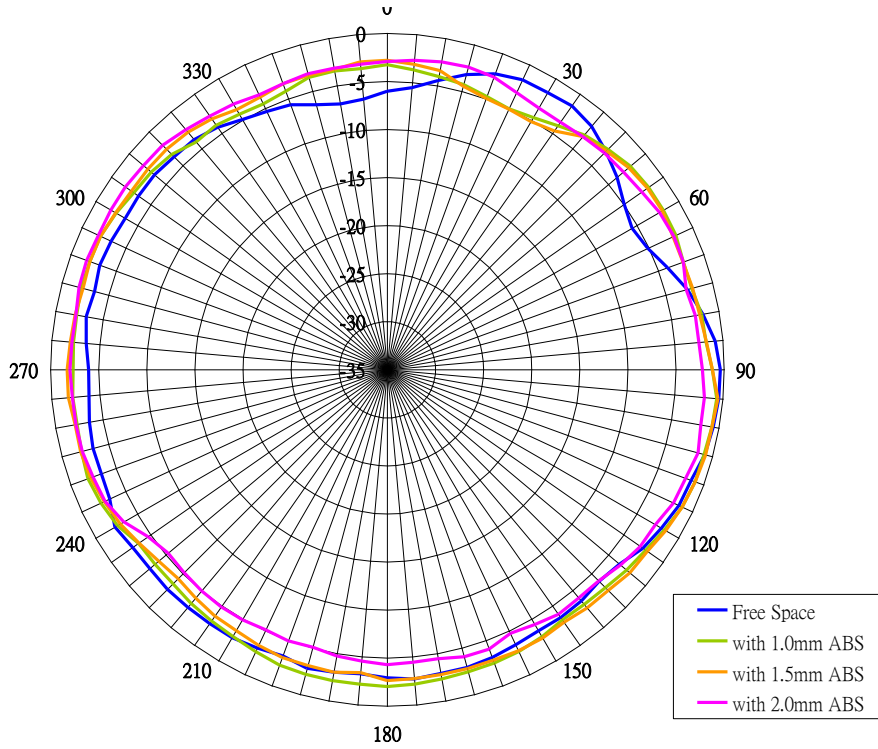

3.3.13 XY plane (at 5000MHz)

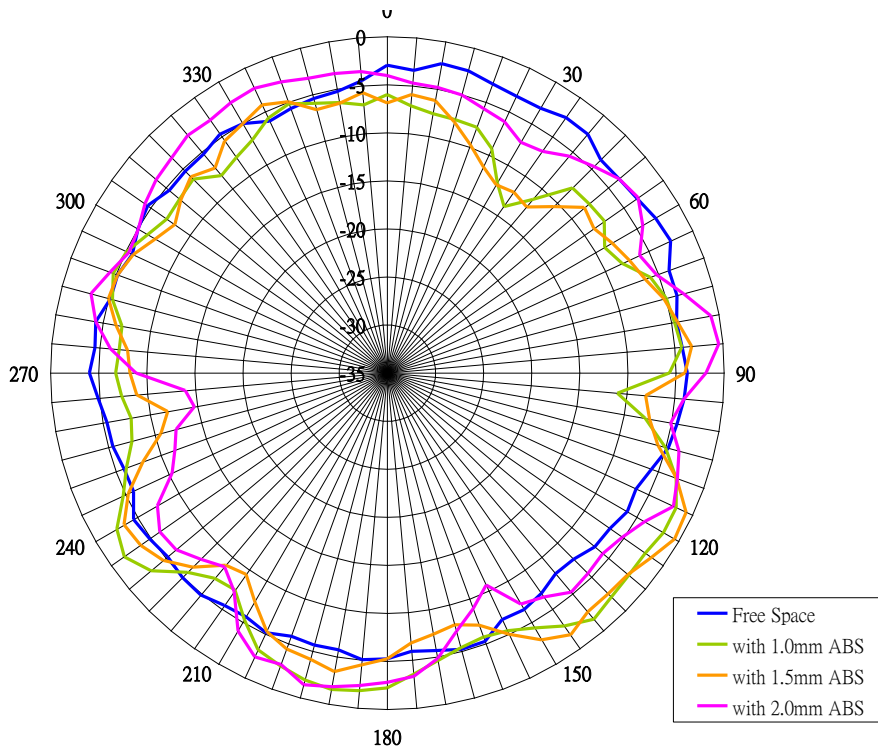

3.3.14 XY plane (at 5500MHz)

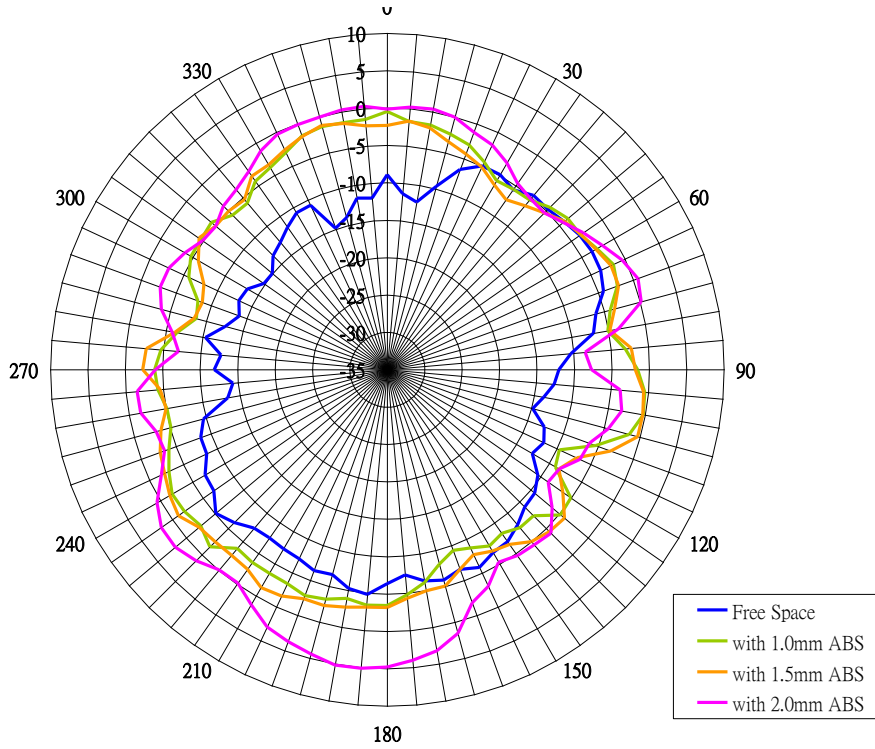

3.3.15 XY plane (at 6000MHz)

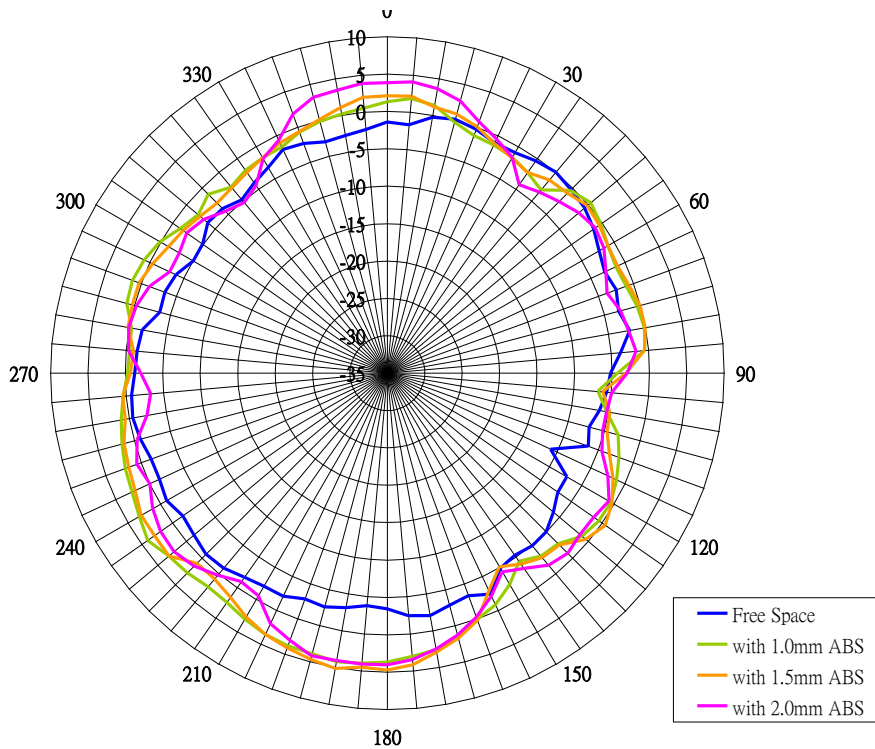

3.4 Peak Gain

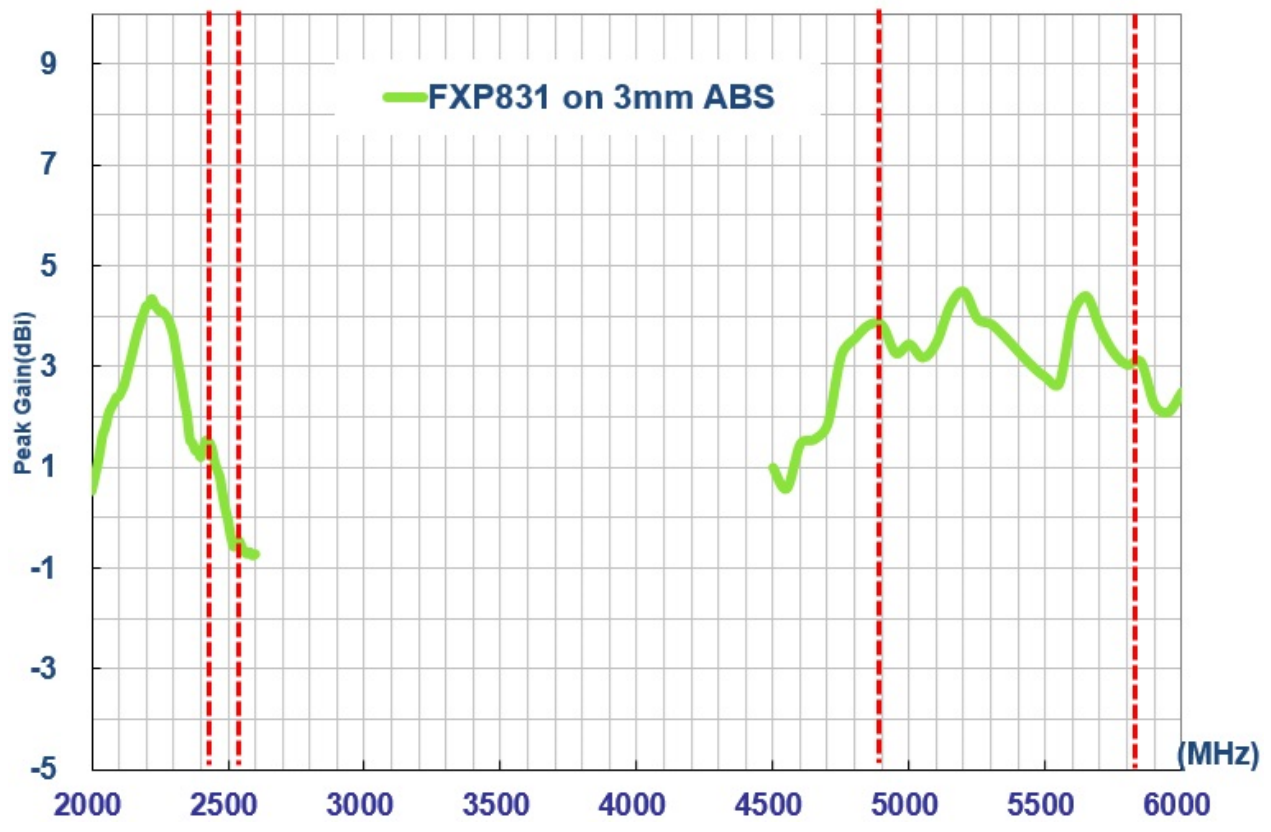
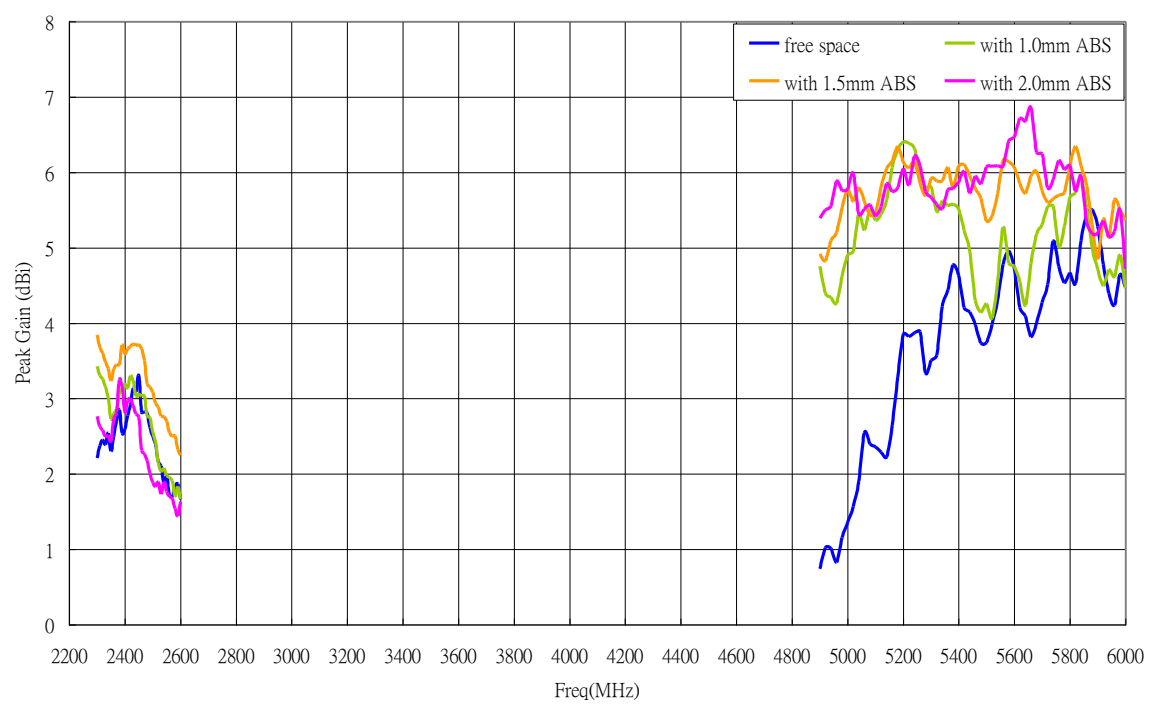

3.5 Efficiency

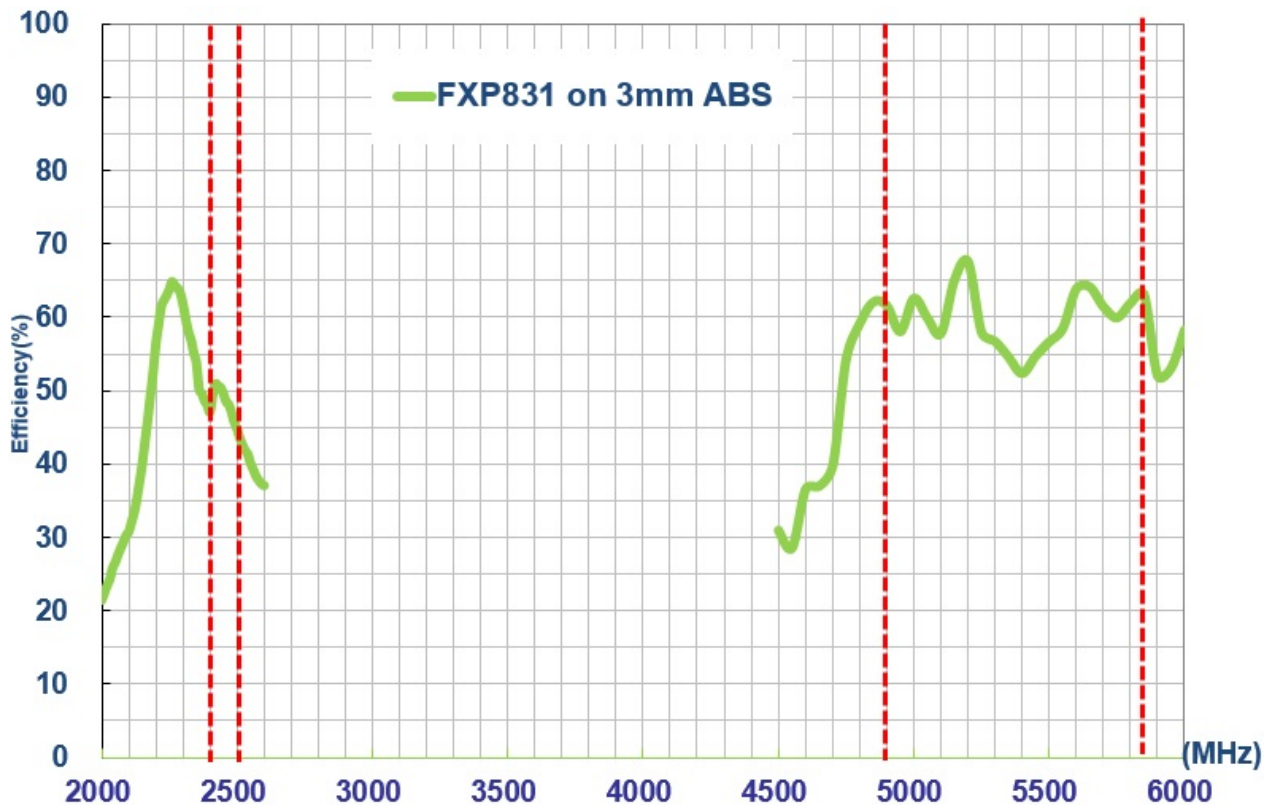
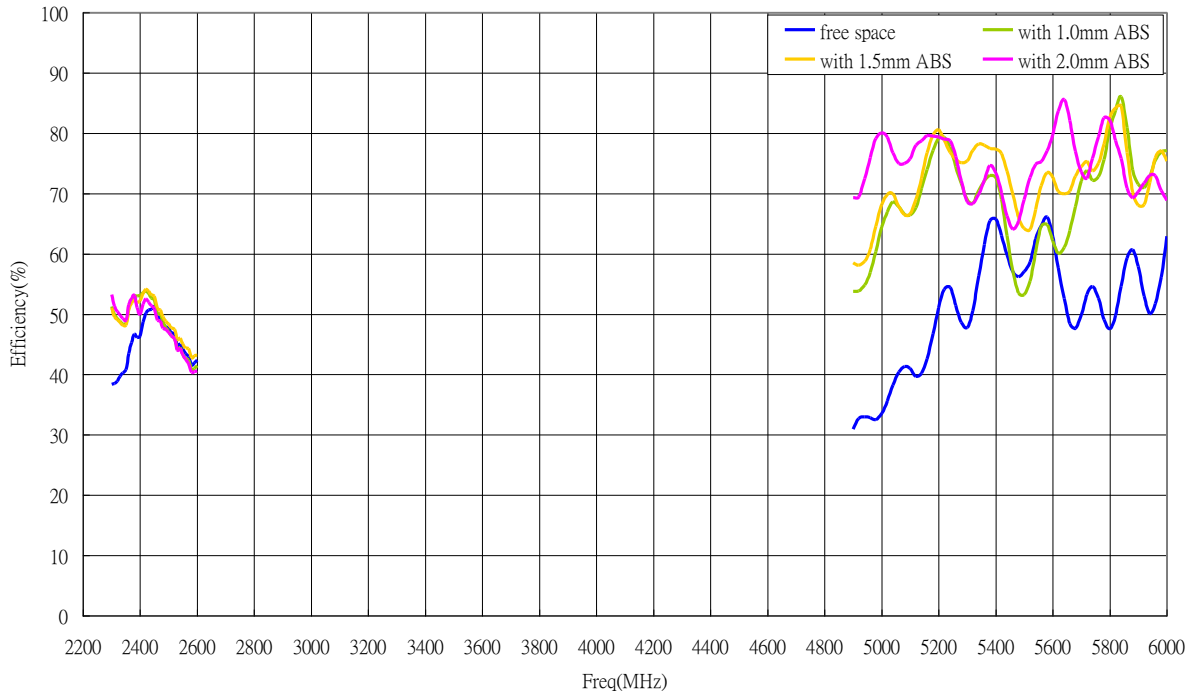

4. Mechanical

4.1 Antenna Dimension

Batch code

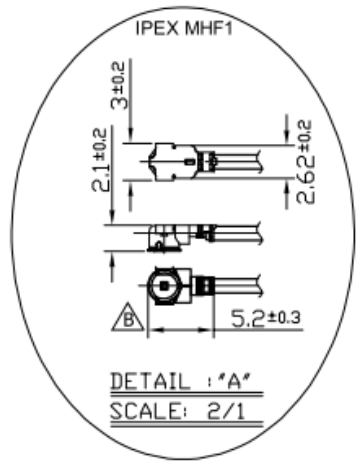
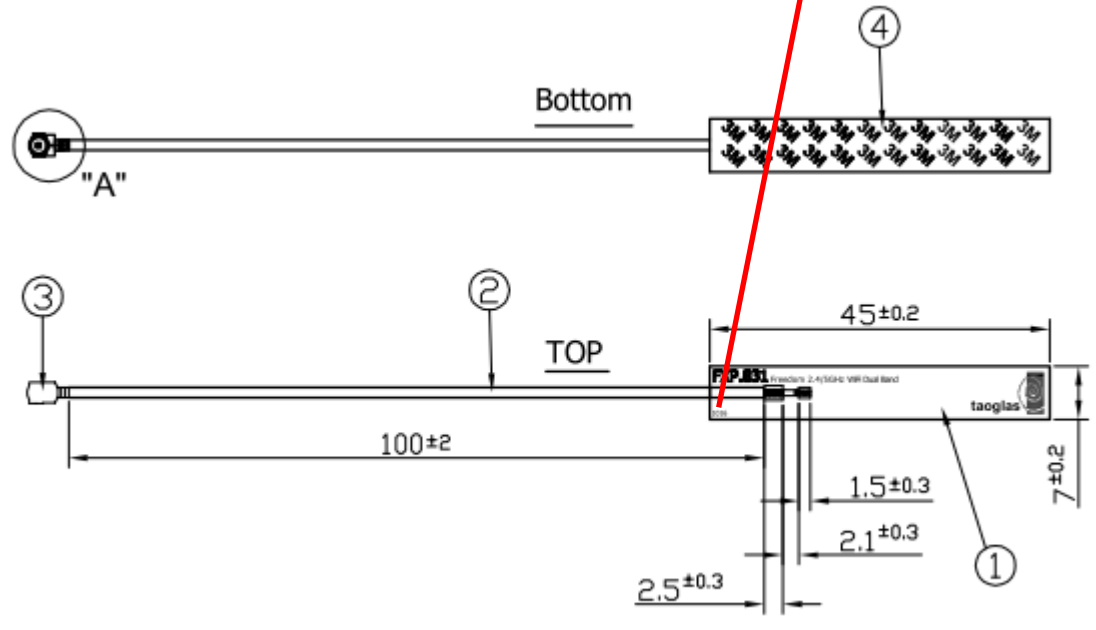

	Name	Material	Finish	QTY
①	FXP831 PCB	FPCB 0.1t	Black	1
②	1.37 Mini-Coaxial Cable	FEP	Gray	1
③	IPEX MHF1	Brass	Gold	1
④	Double-Sided Adhesive	3M 467	Brown Liner	1

5. Precautions for Usage

Mating / unmating

(1) To disconnect connectors, insert the end portion of I-PEX under the connector flanges and pull off vertically, in the direction of the connector mating axis.

(2) To mate the connectors, the mating axes of both connectors must be aligned and the connectors can be mated. The "click" will confirm fully mated connection.

Do not attempt to insert on an extreme angle.

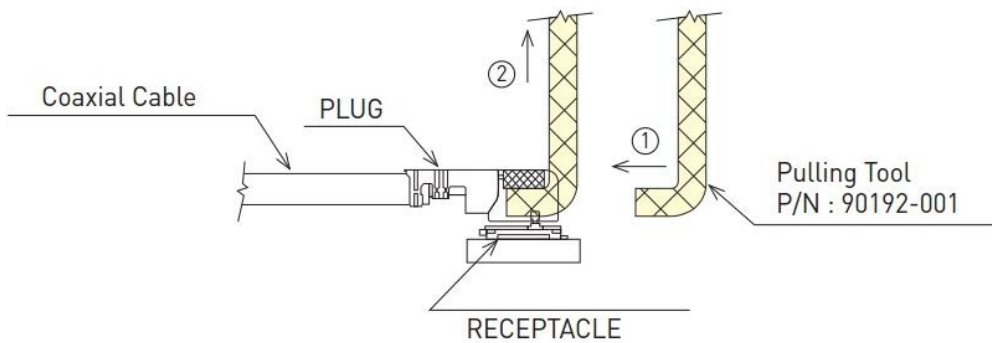

Pull forces on the cable after connectors are mated

After the connectors are mated, do not apply a load to the cable in excess of the values indicated in the diagram below.

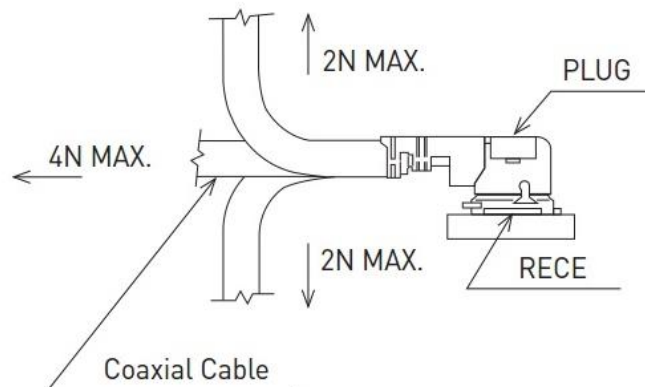

6. Packaging

6.1 Package

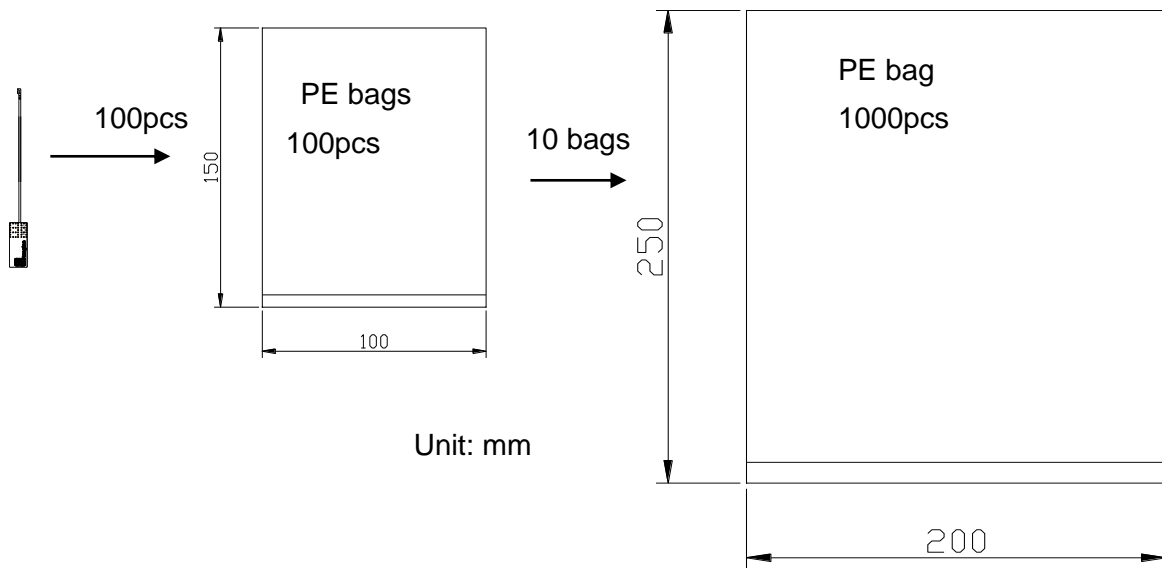

Taoglas makes no warranties based on the accuracy or completeness of the contents of this document and reserves the right to make changes to specifications and product descriptions at any time without notice.

Taoglas reserves all rights to this document and the information contained herein. Reproduction, use or disclosure to third parties without express permission is strictly prohibited. Copyright ©, Taoglas Ltd.

Mouser Electronics

Authorized Distributor

Click to View Pricing, Inventory, Delivery & Lifecycle Information:

[Taoglas:](#)

[FXP831.07.0100C](#)