

ABSOLUTE MAXIMUM RATINGS

Parameters	Symbol	Unit	Value	Comment
Supply voltage	V _{CC}	V	7	
Primary conductor temperature	—	°C	110	
Non repetitive primary current pulse(20 μ S), in powered or unpowered state.	I _p	A	20 × I _f	
ESD(HBM: Human Body Model)	—	kV	4	C=100pF, R=1.5k Ω

ISOLATION CHARACTERISTICS

Parameters	Symbol	Unit	Value	Comment
Insulation voltage	V _d	—	AC4100V, for 1minute(Sensing current 0.5mA)	Primary ↔ Secondary
Insulation Resistance	R _{IS}	—	≧ 500M Ω (at DC500V)	Primary ↔ Secondary
Clearance distance	d _{CI}	—	7.5mm(TYP)	Primary ↔ Secondary
Creepage distance	d _{CP}	—	7.5mm(TYP)	Primary ↔ Secondary
Case material	—	—	UL94 V-0	
Comparative Tracking Index: (CTI)	CTI	V	600	
Application example	—	—	300V, CAT III, PD2	Reinforced isolation,non uniform field according to EN50178, EN61010
	—	—	600V, CAT III, PD2	Simple isolation,non uniform field according to EN50178, EN61010

ENVIRONMENTAL AND MECHANICAL CHARACTERISTICS

Parameters	Symbol	Unit	Value			Comment
			MIN	TYP	MAX	
Ambient operating temperature	T _a	°C	-40		+105	
Ambient storage temperature	T _s	°C	-40		+105	
Mass	m	g		12		



SPECIFICATIONS

Ta=+25°C, RL=10kΩ, Vcc=+5V

Parameters	Symbol	Unit	Value			Comment
			MIN	TYP	MAX	
Rated Current	F02P006S05	If	A		6	
	F02P015S05				15	
	F02P025S05				25	
	F02P050S05				50	
Maximum current (at Vcc=+5V, Ta=+105°C)	F02P006S05	Ipm	A	-20		20
	F02P015S05			-51		51
	F02P025S05			-85		85
	F02P050S05			-150		150
Supply Voltage	Vcc	V	4.75	5.00	5.25	
Number of primary turns	Np	T	1, 2, 3			
Number of secondary turns	F02P006S05	Ns	T		1816	
	F02P015S05				1737	
	F02P025S05				1764	
	F02P050S05				1600	
Consumption current (at If)	F02P006S05	Icc	mA		25	Icc=15+Ip(mA)/Ns
	F02P015S05				30	
	F02P025S05				35	
	F02P050S05				55	
Internal reference voltage (at Ip=0A)	Vref1	V	2.495	2.500	2.505	Ref OUT mode
External reference voltage	Vref2	V	0		4	Ref IN mode
Output voltage	Vo	V	0.375		4.625	
Output voltage (at Ip=0A)	Vo	V		Vref1, Vref2		
Electrical offset voltage	F02P006S05	Voe	mV	-5.300		5.300
	F02P015S05			-2.210		2.210
	F02P025S05			-1.350		1.350
	F02P050S05			-0.725		0.725
Electrical offset current referred to primary	F02P006S05	Ioe	mA	-51		51
	F02P015S05			-53		53
	F02P025S05			-54		54
	F02P050S05			-58		58
Temperature coefficient of Internal reference voltage	TCVref1	ppm/K		±5.0	±50	
Temperature coefficient of Output voltage (at Ip=0A)	F02P006S05	TCVo	ppm/K		±6.0	±14
	F02P015S05				±2.3	±6
	F02P025S05				±1.4	±4
	F02P050S05				±0.7	±3
Sensitivity (Theoretical value)	F02P006S05	Gth	mV/A		104.2	625mV/If
	F02P015S05				41.67	
	F02P025S05				25	
	F02P050S05				12.5	
Sensitivity error	εG	%	-0.7		0.7	
Temperature coefficient of Sensitivity (at Ta=-40°C~+105°C)	TCG	ppm/K			±40	
Output Linearity	εL	%	-0.1		0.1	
Magnetic offset current referred to primary (at 10×If)	Iom	A	-0.1		0.1	
Output current noise referred to primary (at 100Hz~100kHz)	Ino	μA/(Hz) ^{1/2}		20		RL=1kΩ

Offset voltage value is after removal of core hysteresis.

SPECIFICATIONS

Ta=+25°C, RL=10kΩ, Vcc=+5V

Parameters	Symbol	Unit	Value			Comment	
			MIN	TYP	MAX		
Peak to peak output ripple at oscillator frequency(f typ=450kHz)	F02P006S05	—	mV		40	160	RL=1kΩ
	F02P015S05				15	60	
	F02P025S05				10	40	
	F02P050S05				5	20	
Reaction time(at 10% of If)	F02P006S05	tra	μs			0.3	RL=1kΩ, di/dt=18A/μs
	F02P015S05					0.3	RL=1kΩ, di/dt=44A/μs
	F02P025S05					0.3	RL=1kΩ, di/dt=68A/μs
	F02P050S05					0.3	RL=1kΩ, di/dt=100A/μs
Response time 1 (at 90% of If)	F02P006S05	tr	μs			0.3	RL=1kΩ, di/dt=18A/μs
	F02P015S05					0.3	RL=1kΩ, di/dt=44A/μs
	F02P025S05					0.3	RL=1kΩ, di/dt=68A/μs
	F02P050S05					0.3	RL=1kΩ, di/dt=100A/μs
Response time 2 (at 10% of If to 90% of Vo)		tr	μs			0.6	RL=1kΩ, di/dt=If/μs
Frequency bandwidth(±1dB)		BW	kHz	200			RL=1kΩ
Frequency bandwidth(±3dB)		BW	kHz	300			RL=1kΩ
Output Voltage Accuracy(Overall)	F02P006S05	X _G	%			1.7	X _G =(100×V _{oe} /625)+ε _G +ε _L
	F02P015S05					1.2	
	F02P025S05					1.0	
	F02P050S05					0.9	

STANDARDS

EN50178, EN61010-1, EN60950-1, UL508(file No.E243511)

※Please refer to the another sheet about conditions of UL Recognition.

Characteristic curve(TYP)

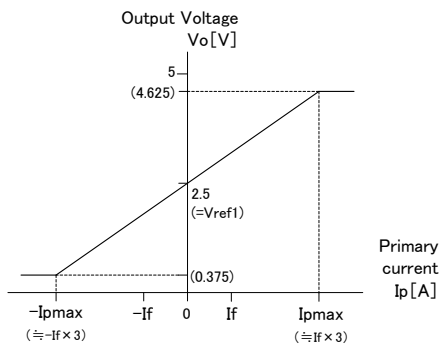

Figure 1: Linearity curve (Internal reference voltage)

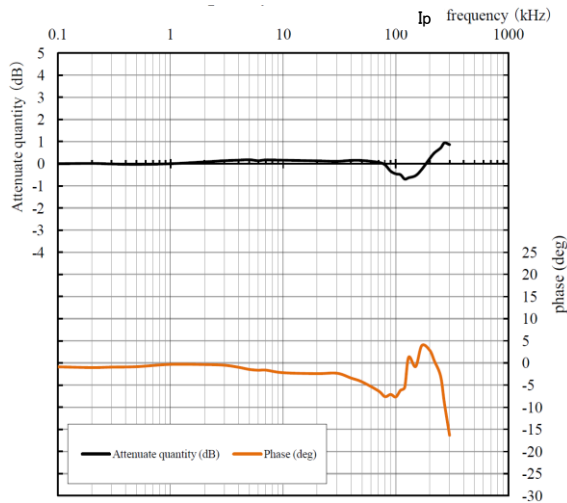

Figure 2: Frequency response curve
ex) F02P025S05

Measurement condition Ta=+25°C, RL=1kΩ, Ip=3A, Vcc=+5V

SUPPORT DOCUMENTATION

Maximum continuous DC primary current

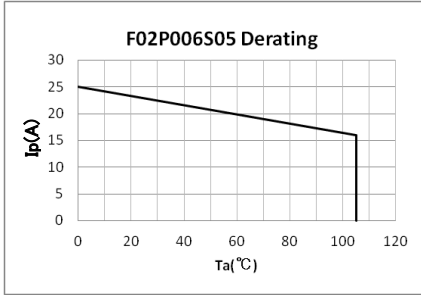

Figure 3 : Ip vs Ta for

F02P006S05

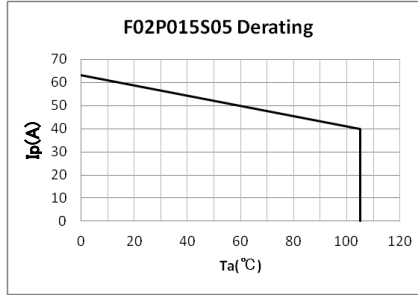

Figure 4: Ip vs Ta for F02P015S05

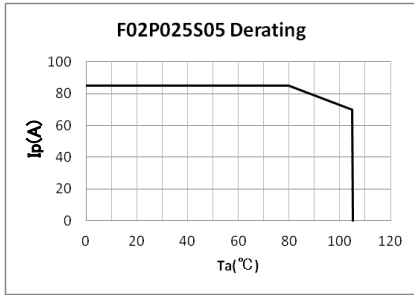

Figure 5 : Ip vs Ta for F02P025S05

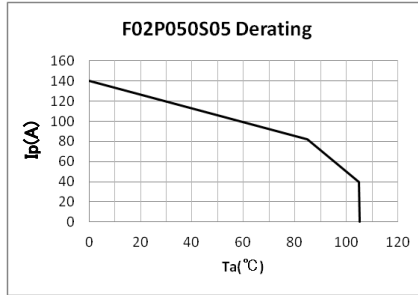

Figure 6: Ip vs Ta for F02P050S05

According to which the following conditions are true the maximum continuous DC primary current plot shows the boundary of the area.

- ① $I_p < I_{pmax}$
- ② Junction temperature $T_j < 125^\circ\text{C}$
- ③ Primary conductor temperature $< 110^\circ\text{C}$
- ④ Resistor power dissipation $< 0.5 \times$ rated power

Frequency derating

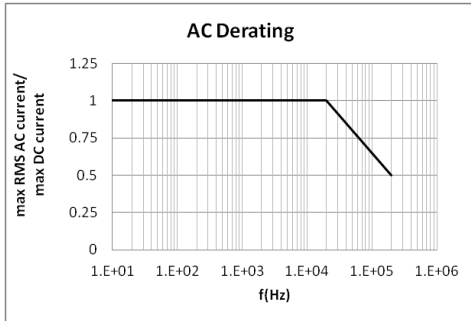

Figure 7 : Maximum RMS AC primary current/maximum DC primary current vs frequency

Reference voltage

The Ref pin has two modes Ref IN and Ref OUT:

<Ref OUT mode>

The 2.5V internal precision reference is used by the transducer as the reference point for bipolar measurements;

<Ref IN mode>

An external reference voltage is connected to the Ref pin; this voltage is specified in the range 0 to 4 V , its voltage is used as the reference voltage at the time of measurement.

-either to source a typical current of $(V_{ref}-2.5)/680$,the maximum value will be 2.2mA typ.when $V_{ref}=4V$.

-or to sink a typical current of $(2.5-V_{ref2})/680$,the maximum value will be 3.68mA typ.when $V_{ref2}=0V$.

The following graphs show how the measuring range of each transducer version depends on external reference voltage value V_{ref2} .

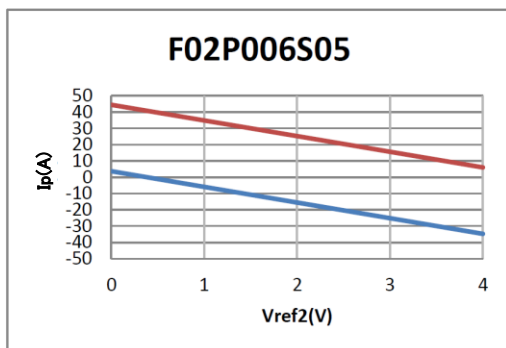

Upper limit: $I_p = -9.6 \times V_{ref2} + 44.4$ ($V_{ref2}=0...4V$)
 Lower limit: $I_p = -9.6 \times V_{ref2} + 3.6$ ($V_{ref2}=0...4V$)

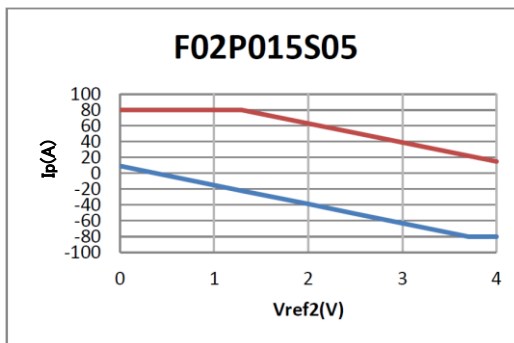

Upper limit: $I_p = 80$ ($V_{ref2}=0...1.29V$)
 $I_p = -24 \times V_{ref2} + 111$ ($V_{ref2}=1.29...4V$)
 Lower limit: $I_p = -24 \times V_{ref2} + 9$ ($V_{ref2}=0...3.7V$)
 $I_p = -80$ ($V_{ref2}=3.7...4V$)

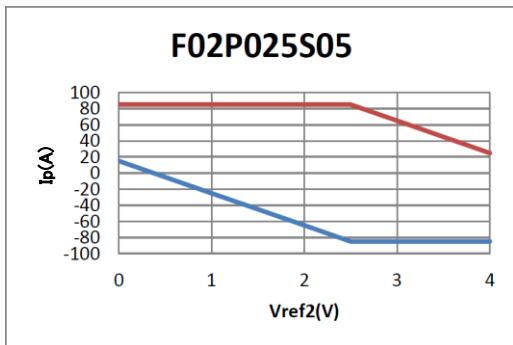

Upper limit: $I_p = 85$ ($V_{ref2}=0...2.5V$)
 $I_p = -40 \times V_{ref2} + 185$ ($V_{ref2}=2.5...4V$)
 Lower limit: $I_p = -40 \times V_{ref2} + 15$ ($V_{ref2}=0...2.5V$)
 $I_p = -85$ ($V_{ref2}=2.5...4V$)

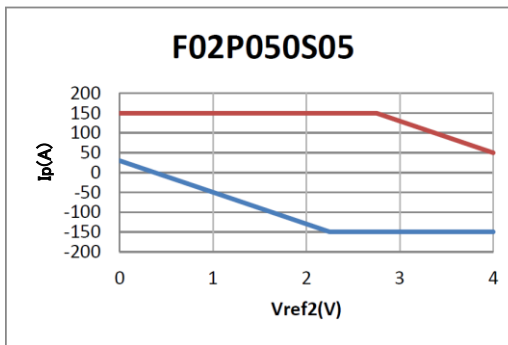

Upper limit: $I_p = 150$ ($V_{ref2}=0...2.75V$)
 $I_p = -80 \times V_{ref2} + 370$ ($V_{ref2}=2.75...4V$)
 Lower limit: $I_p = -80 \times V_{ref2} + 30$ ($V_{ref2}=0...2.25V$)
 $I_p = -150$ ($V_{ref2}=2.25...4V$)

If you do not want to use the Ref pin, please unconnected.

CONNECTION

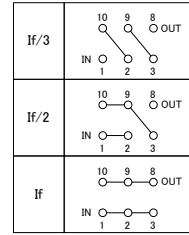
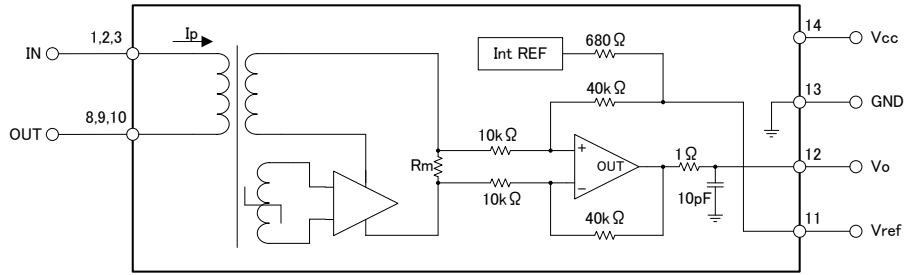

DIMENSIONS(mm)

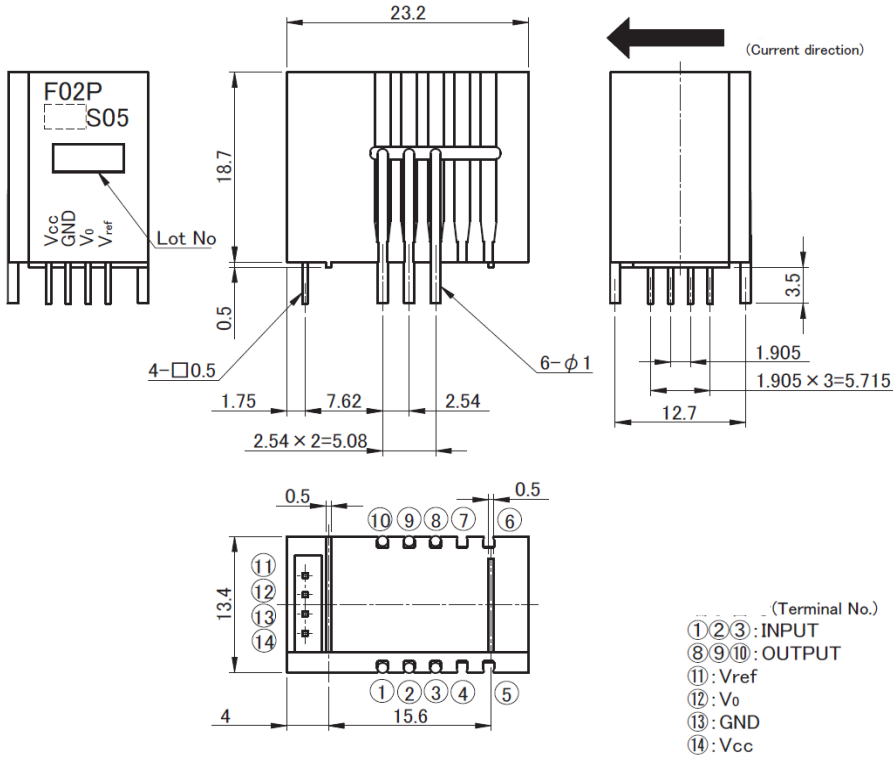

※ (Unless otherwise specified tolerances shall be ±0.5)

RECOMMENDED HOLE DIAMETER(mm)

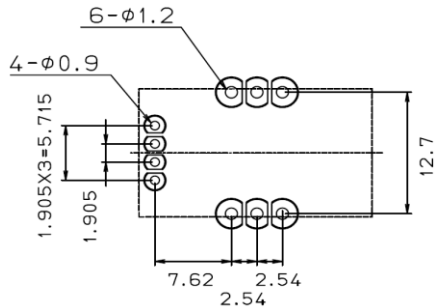

Mouser Electronics

Authorized Distributor

Click to View Pricing, Inventory, Delivery & Lifecycle Information:

[Tamura:](#)

[F02P025S05](#) [F02P050S05](#) [F02P015S05](#) [F02P006S05](#)