

## PQxxxDNA1ZPH Series

Compact Surface Mount type  
Low Power-Loss Voltage Regulators

### ■ Features

1. Output current : 1A
2. High isolation voltage  $V_{IN}$ : MAX. 24 V
3. Low dissipation current  
(Dissipation current at no load: MAX. 8mA  
Output OFF-state dissipation current: MAX. 5 $\mu$ A)
4. Built-in ON/OFF function
5. Built-in overcurrent and overheat protection functions
6. Built-in ASO protection function
7. Ceramic capacitor compatible
8. RoHS directive compliant

### ■ Applications

1. AV equipment
2. OA equipment

### ■ Model Line-up

Output Voltage (TYP.)	Model No.
3.3V	PQ033DNA1ZPH
5.0V	PQ050DNA1ZPH
8.0V	PQ080DNA1ZPH
9.0V	PQ090DNA1ZPH
12.0V	PQ120DNA1ZPH

### ■ Absolute Maximum Ratings

( $T_a=25^\circ\text{C}$ )

Parameter	Symbol	Rating	Unit
*1 Input voltage	$V_{IN}$	24	V
*1 Output control voltage	$V_C$	24	V
Output current	$I_O$	1	A
*2 Power dissipation	$P_D$	8	W
*3 Junction temperature	$T_j$	150	$^\circ\text{C}$
Operating temperature	$T_{opr}$	-40 to +85	$^\circ\text{C}$
Storage temperature	$T_{stg}$	-40 to +150	$^\circ\text{C}$
Soldering temperature	$T_{sol}$	260(10s)	$^\circ\text{C}$

- \*1 All are open except GND and applicable terminals.  
 \*2  $P_D$ : With infinite heat sink  
 \*3 Overheat protection may operate at  $T_j$ : 125 $^\circ\text{C}$  to 150 $^\circ\text{C}$

### ■ Outline Dimensions

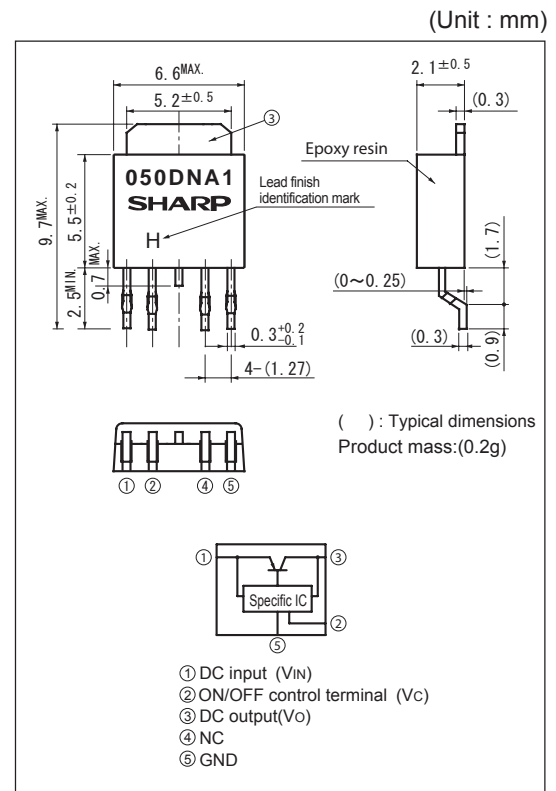

Lead finish: Lead-free solder plating  
(Composition: Sn2Cu)

Notice The content of data sheet is subject to change without prior notice.

In the absence of confirmation by device specification sheets, SHARP takes no responsibility for any defects that may occur in equipment using any SHARP devices shown in catalogs, data books, etc. Contact SHARP in order to obtain the latest device specification sheets before using any SHARP device.

### Electrical Characteristics

#### (1) PQ033DNA1ZPH

(Unless otherwise specified, condition shall be  $V_{IN}=5V, I_o=0.5A, V_C=2.7V, T_a=25^\circ C$ )

Parameter	Symbol	Conditions	MIN.	TYP.	MAX.	Unit
Output voltage	$V_O$	-	3.218	3.3	3.382	V
Load regulation	$Reg_L$	$I_o=5mA$ to 1A	-	0.2	1.0	%
Line regulation	$Reg_l$	$V_{IN}=4$ to 14V, $I_o=5mA$	-	0.2	1.0	%
Temperature coefficient of output voltage	$T_C V_O$	$T_j=0$ to $+125^\circ C$ , $I_o=5mA$	-	$\pm 0.01$	-	$\%/^\circ C$
Ripple rejection	RR	Refer to Fig.3	-	60	-	dB
Dropout voltage	$V_{I-O}$	$V_{IN}=3.5V, I_o=0.5A$	-	0.2	0.5	V
*5 ON-state voltage for control	$V_{C(ON)}$	-	2.0	-	-	V
ON-state current for control	$I_{C(ON)}$	$V_C=2.7V$	-	-	200	$\mu A$
OFF-state voltage for control	$V_{C(OFF)}$	-	-	-	0.8	V
OFF-state current for control	$I_{C(OFF)}$	$V_C=0.4V$	-	-	2	$\mu A$
Quiescent current	$I_q$	$I_o=0A$	-	4	8	mA
Output OFF-state dissipation current	$I_{qs}$	$I_o=0A, V_C=0.4V$	-	-	5	$\mu A$

\*5 In case of opening control terminal ②, output voltage turns off

#### (2) PQ050DNA1ZPH

(Unless otherwise specified, condition shall be  $V_{IN}=7V, I_o=0.5A, V_C=2.7V, T_a=25^\circ C$ )

Parameter	Symbol	Conditions	MIN.	TYP.	MAX.	Unit
Output voltage	$V_O$	-	4.875	5.0	5.125	V
Load regulation	$Reg_L$	$I_o=5mA$ to 1A	-	0.2	1.0	%
Line regulation	$Reg_l$	$V_{IN}=6$ to 16V, $I_o=5mA$	-	0.2	1.0	%
Temperature coefficient of output voltage	$T_C V_O$	$T_j=0$ to $+125^\circ C$ , $I_o=5mA$	-	$\pm 0.01$	-	$\%/^\circ C$
Ripple rejection	RR	Refer to Fig.3	-	60	-	dB
Dropout voltage	$V_{I-O}$	*4, $I_o=0.5A$	-	0.2	0.5	V
*5 ON-state voltage for control	$V_{C(ON)}$	-	2.0	-	-	V
ON-state current for control	$I_{C(ON)}$	$V_C=2.7V$	-	-	200	$\mu A$
OFF-state voltage for control	$V_{C(OFF)}$	-	-	-	0.8	V
OFF-state current for control	$I_{C(OFF)}$	$V_C=0.4V$	-	-	2	$\mu A$
Quiescent current	$I_q$	$I_o=0A$	-	4	8	mA
Output OFF-state dissipation current	$I_{qs}$	$I_o=0A, V_C=0.4V$	-	-	5	$\mu A$

\*4 Input voltage shall be the value when output voltage is 95% in comparison with the initial value.

\*5 In case of opening control terminal ②, output voltage turns off

#### (3) PQ080DNA1ZPH

(Unless otherwise specified, condition shall be  $V_{IN}=10V, I_o=0.5A, V_C=2.7V, T_a=25^\circ C$ )

Parameter	Symbol	Conditions	MIN.	TYP.	MAX.	Unit
Output voltage	$V_O$	-	7.8	8.0	8.2	V
Load regulation	$Reg_L$	$I_o=5mA$ to 1A	-	0.2	1.0	%
Line regulation	$Reg_l$	$V_{IN}=9$ to 19V, $I_o=5mA$	-	0.2	1.0	%
Temperature coefficient of output voltage	$T_C V_O$	$T_j=0$ to $+125^\circ C$ , $I_o=5mA$	-	$\pm 0.01$	-	$\%/^\circ C$
Ripple rejection	RR	Refer to Fig.3	-	60	-	dB
Dropout voltage	$V_{I-O}$	*4, $I_o=0.5A$	-	0.2	0.5	V
*5 ON-state voltage for control	$V_{C(ON)}$	-	2.0	-	-	V
ON-state current for control	$I_{C(ON)}$	$V_C=2.7V$	-	-	200	$\mu A$
OFF-state voltage for control	$V_{C(OFF)}$	-	-	-	0.8	V
OFF-state current for control	$I_{C(OFF)}$	$V_C=0.4V$	-	-	2	$\mu A$
Quiescent current	$I_q$	$I_o=0A$	-	4	8	mA
Output OFF-state dissipation current	$I_{qs}$	$I_o=0A, V_C=0.4V$	-	-	5	$\mu A$

\*4 Input voltage shall be the value when output voltage is 95% in comparison with the initial value.

\*5 In case of opening control terminal ②, output voltage turns off

### (4) PQ090DNA1ZPH

(Unless otherwise specified, condition shall be  $V_{IN}=11V, I_o=0.5A, V_c=2.7V, T_a=25^{\circ}C$ )

Parameter	Symbol	Conditions	MIN.	TYP.	MAX.	Unit
Output voltage	$V_o$	-	8.775	9.0	9.225	V
Load regulation	$RegL$	$I_o=5mA$ to 1A	-	0.2	1.0	%
Line regulation	$Regl$	$V_{IN}=10$ to 20V, $I_o=5mA$	-	0.2	1.0	%
Temperature coefficient of output voltage	$TcVo$	$T_j=0$ to $+125^{\circ}C, I_o=5mA$	-	$\pm 0.01$	-	%/ $^{\circ}C$
Ripple rejection	RR	Refer to Fig.3	-	60	-	dB
Dropout voltage	$V_{I-O}$	*4, $I_o=0.5A$	-	0.2	0.5	V
*5 ON-state voltage for control	$V_{C(ON)}$	-	2.0	-	-	V
ON-state current for control	$I_{C(ON)}$	$V_c=2.7V$	-	-	200	$\mu A$
OFF-state voltage for control	$V_{C(OFF)}$	-	-	-	0.8	V
OFF-state current for control	$I_{C(OFF)}$	$V_c=0.4V$	-	-	2	$\mu A$
Quiescent current	$I_q$	$I_o=0A$	-	4	8	mA
Output OFF-state dissipation current	$I_{qs}$	$I_o=0A, V_c=0.4V$	-	-	5	$\mu A$

\*4 Input voltage shall be the value when output voltage is 95% in comparison with the initial value.

\*5 In case of opening control terminal ②, output voltage turns off

### (5) PQ120DNA1ZPH

(Unless otherwise specified, condition shall be  $V_{IN}=14V, I_o=0.5A, V_c=2.7V, T_a=25^{\circ}C$ )

Parameter	Symbol	Conditions	MIN.	TYP.	MAX.	Unit
Output voltage	$V_o$	-	11.7	12.0	12.3	V
Load regulation	$RegL$	$I_o=5mA$ to 1A	-	0.2	1.0	%
Line regulation	$Regl$	$V_{IN}=13$ to 23V, $I_o=5mA$	-	0.2	1.0	%
Temperature coefficient of output voltage	$TcVo$	$T_j=0$ to $+125^{\circ}C, I_o=5mA$	-	$\pm 0.01$	-	%/ $^{\circ}C$
Ripple rejection	RR	Refer to Fig.3	-	60	-	dB
Dropout voltage	$V_{I-O}$	*4, $I_o=0.5A$	-	0.2	0.5	V
*5 ON-state voltage for control	$V_{C(ON)}$	-	2.0	-	-	V
ON-state current for control	$I_{C(ON)}$	$V_c=2.7V$	-	-	200	$\mu A$
OFF-state voltage for control	$V_{C(OFF)}$	-	-	-	0.8	V
OFF-state current for control	$I_{C(OFF)}$	$V_c=0.4V$	-	-	2	$\mu A$
Quiescent current	$I_q$	$I_o=0A$	-	4	8	mA
Output OFF-state dissipation current	$I_{qs}$	$I_o=0A, V_c=0.4V$	-	-	5	$\mu A$

\*4 Input voltage shall be the value when output voltage is 95% in comparison with the initial value.

\*5 In case of opening control terminal ②, output voltage turns off

Fig.1 Example of application

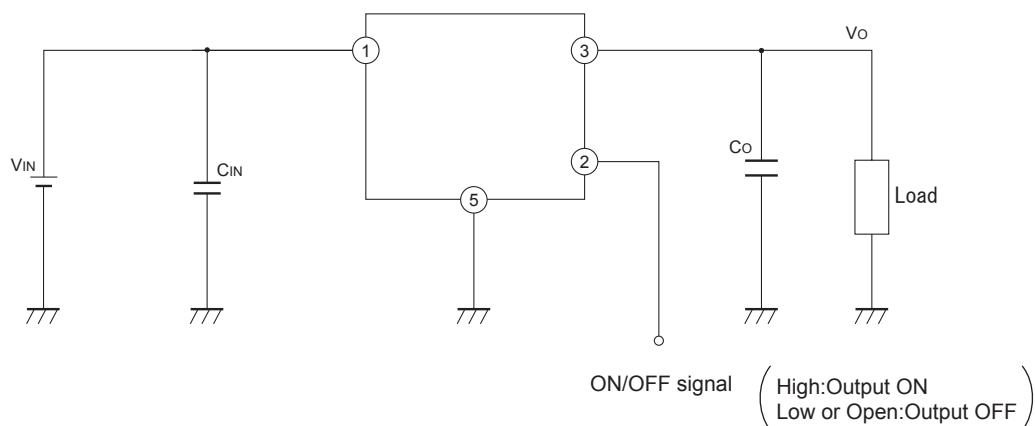

Fig.2 Test Circuit

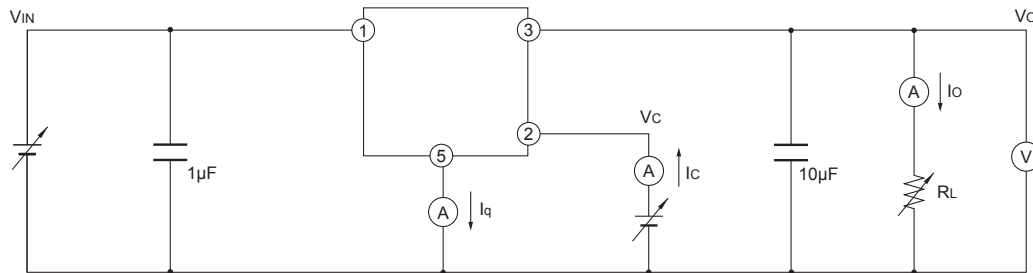
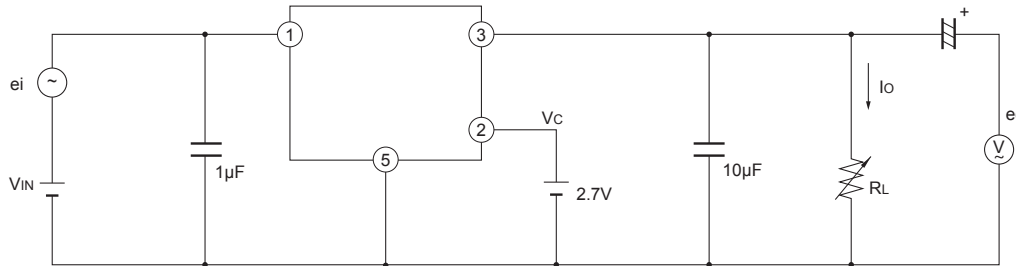
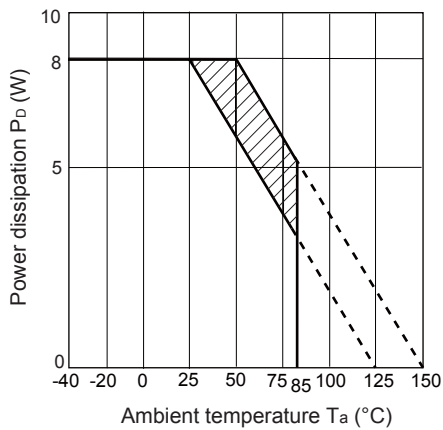

Fig.3 Test Circuit for Ripple Rejection



$f=120\text{Hz}(\text{sine wave})$   
 $e_i(\text{rms})=0.5\text{V}$   
 $V_{IN}=5\text{V}(\text{PQ033DNA1ZPH})$   
 $7\text{V}(\text{PQ050DNA1ZPH})$   
 $10\text{V}(\text{PQ080DNA1ZPH})$   
 $11\text{V}(\text{PQ090DNA1ZPH})$   
 $14\text{V}(\text{PQ120DNA1ZPH})$   
 $I_O=0.3\text{A}$   
 $RR=20\log(e_i(\text{rms})/e_o(\text{rms}))$

Fig.4 Power Dissipation vs. Ambient Temperature



Note) Oblique line portion: Overheat protection may operate in this area.

Fig.5 Overcurrent Protection Characteristics (PQ033DNA1ZPH)

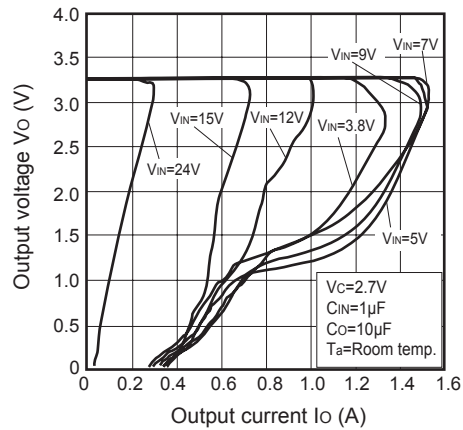

Fig.6 Overcurrent Protection Characteristics (PQ050DNA1ZPH)

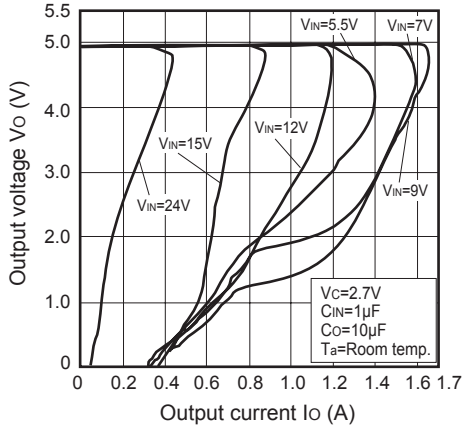

Fig.7 Overcurrent Protection Characteristics (PQ090DNA1ZPH)

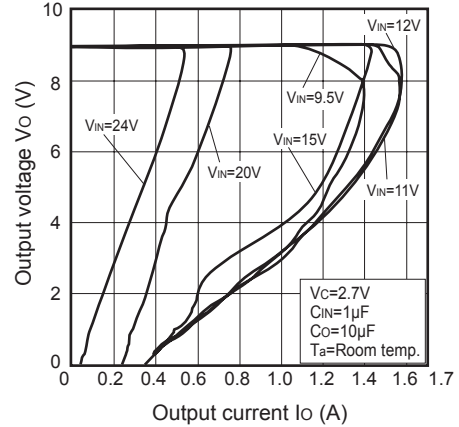

Fig.8 Overcurrent Protection Characteristics (PQ120DNA1ZPH)

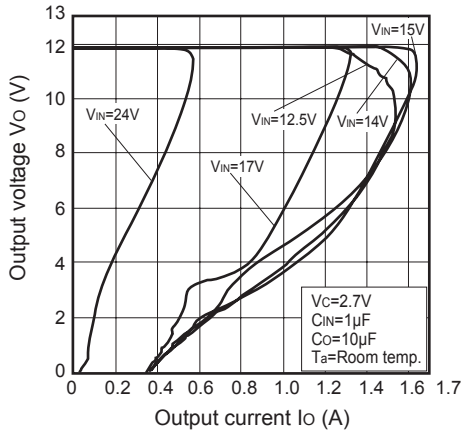

Fig.9 Output Voltage vs. Ambient Temperature (PQ120DNA1ZPH)

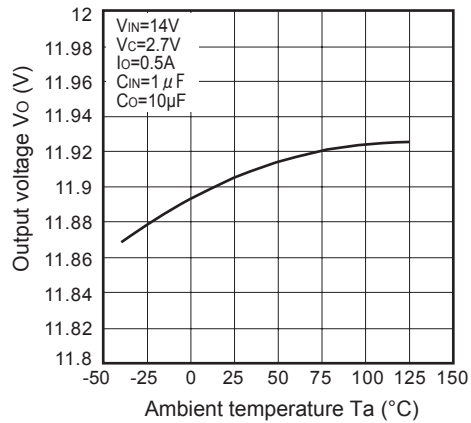

Fig.10 Output Voltage vs. Input Voltage (PQ120DNA1ZPH)

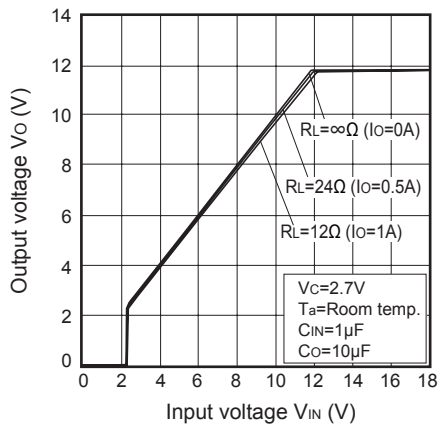

Fig.11 Circuit Operating Current vs. Input Voltage (PQ120DNA1ZPH)

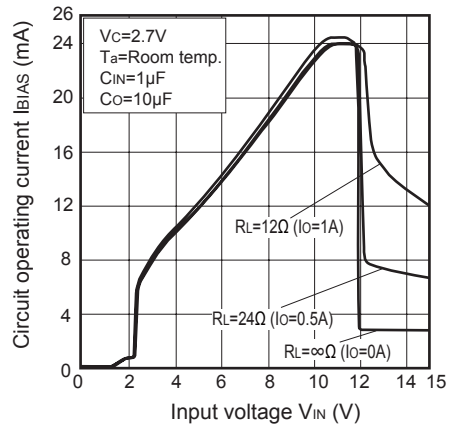

Fig.12 Quiescent Current vs. Ambient Temperature (PQ120DNA1ZPH)

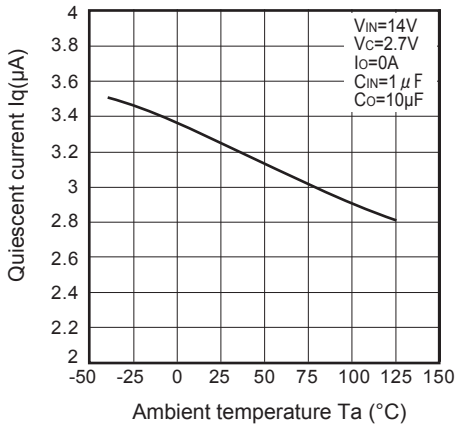

Fig.13 Dropout Voltage vs. Ambient Temperature (PQ120DNA1ZPH)

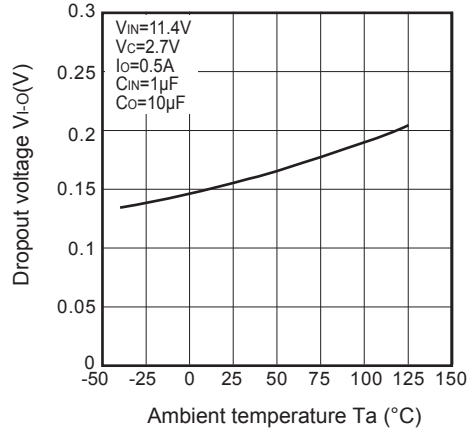

Fig.14 Ripple Rejection vs. Input Ripple Frequency (PQ120DNA1ZPH)

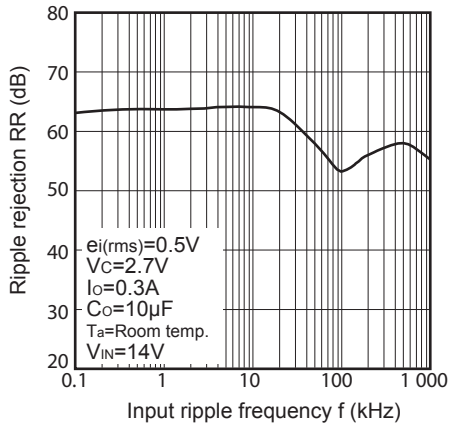

Fig.15 Ripple Rejection vs. Output Current (PQ120DNA1ZPH)

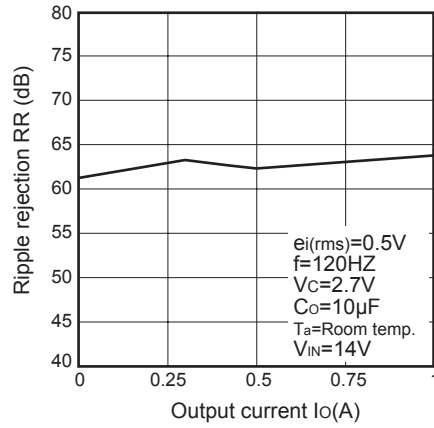
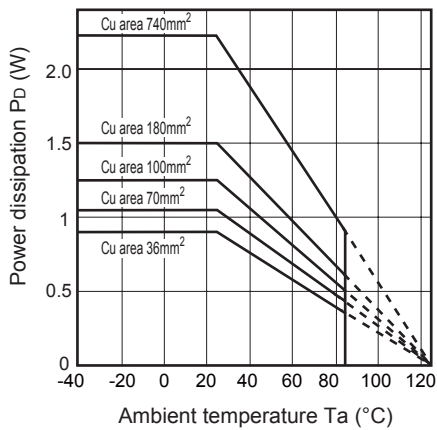
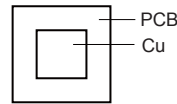

Fig.16 Power Dissipation vs. Ambient Temperature (Typical Value)



Mounting PCB



Material : Glass-cloth epoxy resin  
 Size : 50×50×1.6mm  
 Cu thickness : 35µm

# Mouser Electronics

Authorized Distributor

Click to View Pricing, Inventory, Delivery & Lifecycle Information:

## Sharp Microelectronics:

[PQ090DNA1ZPH](#) [PQ050DNA1ZPH](#) [PQ120DNA1ZPH](#) [PQ080DNA1ZPH](#) [PQ033DNA1ZPH](#) [PQ050DNA1ZZH](#)  
[PQ120DNA1ZZH](#) [PQ033DNA1ZZH](#) [PQ080DNA1ZZH](#)