

FAST RECOVERY RECTIFIER

VOLTAGE RANGE 200 to 1000 Volts CURRENT 1.0 Ampere

FEATURES

- * High switching capability
- * Low leakage
- * Low forward voltage drop
- * High current capability
- * High surge current capability

MECHANICAL DATA

- * Case: Molded plastic
- * Epoxy: Device has UL flammability classification 94V-0
- * Lead: MIL-STD-202E method 208C guaranteed
- * Mounting position: Any
- * Weight: 0.33 gram

MAXIMUM RATINGS AND ELECTRICAL CHARACTERISTICS

Ratings at 25 °C ambient temperature unless otherwise specified.
 Single phase, half wave, 60 Hz, resistive or inductive load.
 For capacitive load, derate current by 20%.

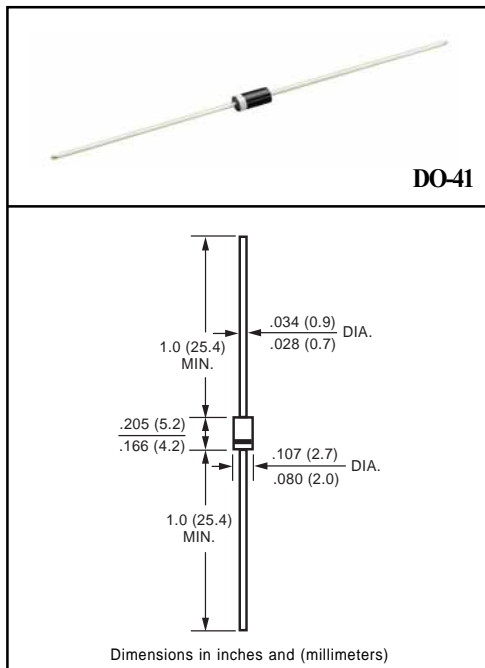

MAXIMUM RATINGS (At TA = 25°C unless otherwise noted)

RATINGS	SYMBOL	1N4942	1N4944	1N4946	1N4947	1N4948	UNITS
Maximum Recurrent Peak Reverse Voltage	VRRM	200	400	600	800	1000	Volts
Maximum RMS Voltage	VRMS	140	280	420	560	700	Volts
Maximum DC Blocking Voltage	VDC	200	400	600	800	1000	Volts
Maximum Average Forward Rectified Current at TA = 75°C	Io	1.0					Amps
Peak Forward Surge Current 8.3 ms single half sine-wave superimposed on rated load (JEDEC method)	IFSM	30					Amps
Typical Junction Capacitance (Note 2)	CJ	15					pF
Operating and Storage Temperature Range	TJ, TSTG	-55 to + 150					°C

ELECTRICAL CHARACTERISTICS (At TA = 25°C unless otherwise noted)

CHARACTERISTICS	SYMBOL	1N4942	1N4944	1N4946	1N4947	1N4948	UNITS
Maximum Instantaneous Forward Voltage at 1.0A DC	VF	1.3					Volts
Maximum DC Reverse Current at Rated DC Blocking Voltage TA = 25°C	IR	5.0					uAmps
Maximum Full Load Reverse Current Full Cycle Average, .375" (9.5mm) lead length at TL = 55°C		100					uAmps
Maximum Reverse Recovery Time (Note 1)	trr	150		250	500	nSec	

NOTES : 1. Test Conditions: IF = 0.5A, IR = -1.0A, IRR = -0.25A

2. Measured at 1 MHz and applied reverse voltage of 4.0 volts

RATING AND CHARACTERISTIC CURVES (1N4942 THRU 1N4948)

FIG. 1 - TYPICAL FORWARD CURRENT DERATING CURVE

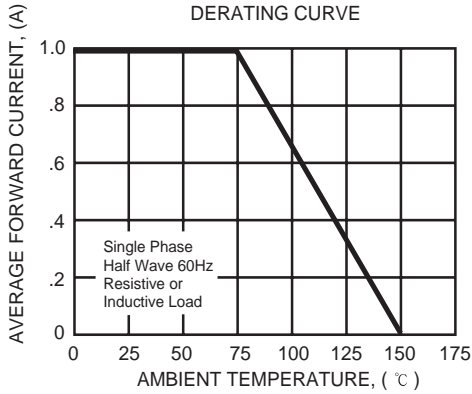

FIG. 2 - TYPICAL INSTANTANEOUS FORWARD CHARACTERISTICS

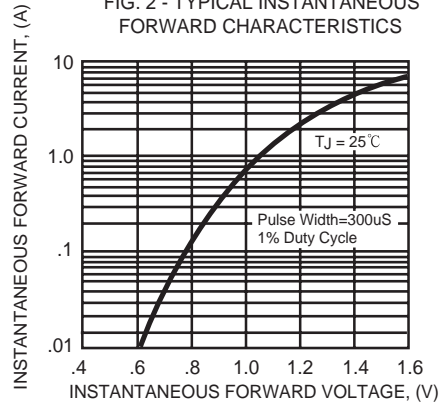

FIG. 2 - MAXIMUM NON-REPETITIVE FORWARD SURGE CURRENT

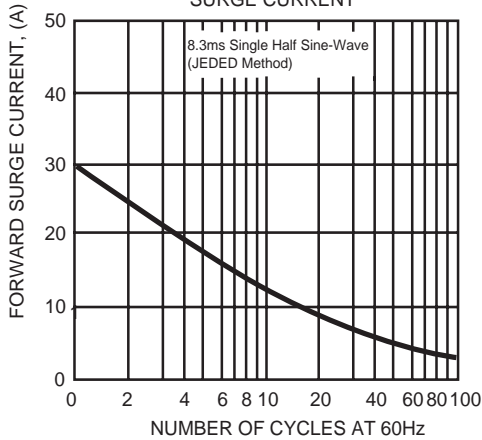

FIG. 4 - TYPICAL REVERSE CHARACTERISTICS

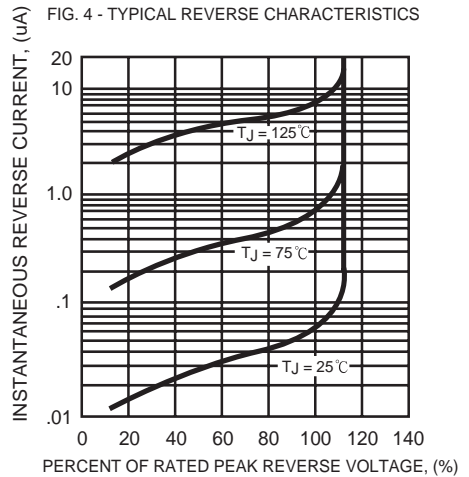

FIG. 3 - TYPICAL JUNCTION CAPACITANCE

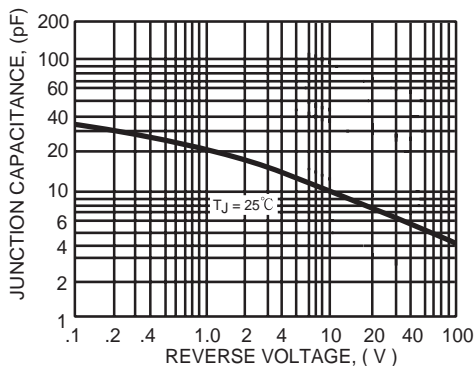
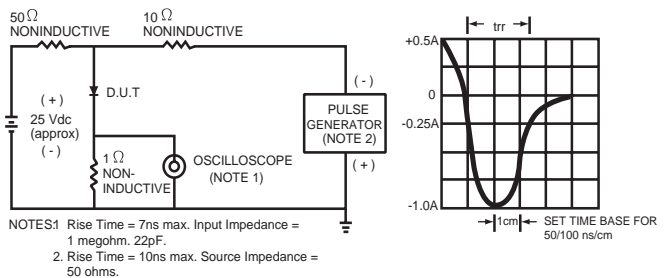

FIG. 6 - TEST CIRCUIT DIAGRAM AND REVERSE RECOVERY TIME CHARACTERISTIC



Mouser Electronics

Authorized Distributor

Click to View Pricing, Inventory, Delivery & Lifecycle Information:

[Rectron:](#)

[1N4947-T](#) [1N4948-B](#) [1N4946-B](#) [1N4947-B](#) [1N4944-B](#) [1N4948-T](#) [1N4944-T](#) [1N4942-B](#) [1N4942-T](#) [1N4946-T](#)