

SD Card Adapter Kit (#32313)

The SD Card Adapter Kit allows you to easily connect an SD Flash Memory Card to your Propeller™ chip or other microcontroller. This adapter contains the components required for an SPI interface between the host microcontroller and the SD memory card. The SD Card Adapter Kit includes a card detect switch which allows you to detect when a memory card is physically present in the socket. It also includes a switch to determine the read/write status of the inserted card, preventing accidental loss of data. Mounting holes are available so you can install the adapter in your application.

Features

- Contains all support components necessary for interfacing with a microcontroller
- Includes mounting holes for end use in application
- Card detect switch allows detection of memory card insertion
- SIP header makes breadboard use easy

Key Specifications

- Power requirements: 3.3V (current determined by card used; plus 0.5 mA when card is inserted)
- Communication: SPI / SDIO
- Operating temperature: 32 to 158 °F (0 to 70 °C)
- Dimensions (assembled): 1.70" L x 1.74" W x 0.52" H (43.2 mm x 44.2 mm x 13.2 mm)

Application Ideas

- Add mass storage to an existing project
- Datalogger

Kit Contents

- SD Card Adapter PCB
- SD Card Socket
- (8) 10K resistors (1206 SMD package)
- 10-pin SIP header

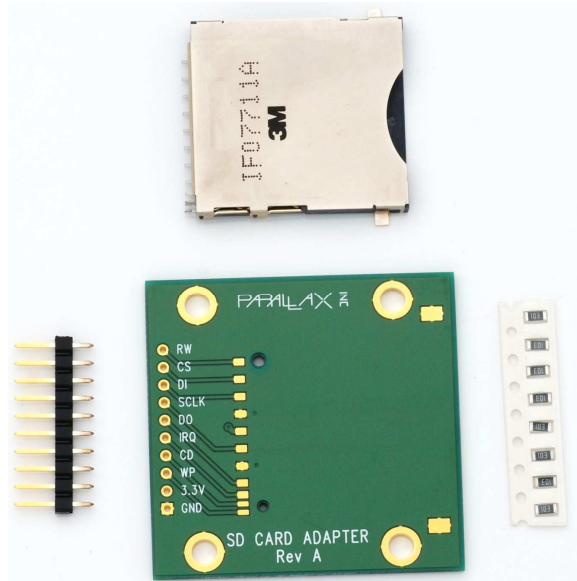

Assembly Instructions

Step 1:

Locate the SD Card Adapter PCB and the eight (8) 10 kΩ SMD resistors. Solder the resistors to the bottom side of the PCB as shown.

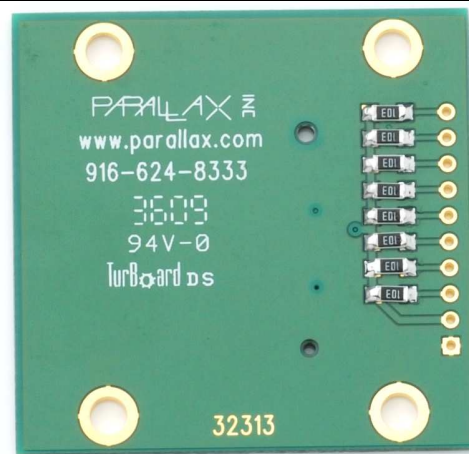

Step 2:

Locate the SD Card Socket and place it on top of the PCB so that the registration holes line up and solder it in place as shown. Be very careful when soldering the bottom pins on the socket, which are very close together. Avoid bridging these by using flux when soldering.

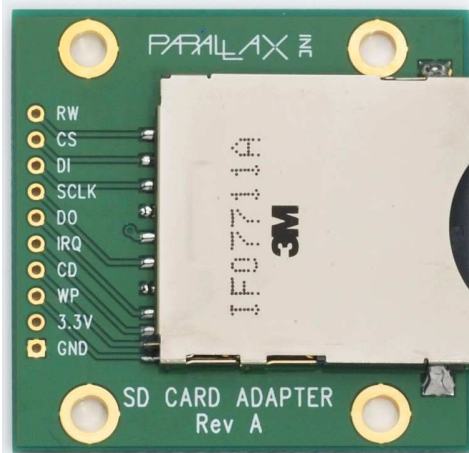

Step 3 (optional):

If you plan on being able to plug your SD Card Adapter into a breadboard you will want to install the 10-pin SIP header.

Locate the 10-pin SIP header in the kit and solder it in place as shown.

You could also have soldered in a ribbon cable or some other cable/connection.

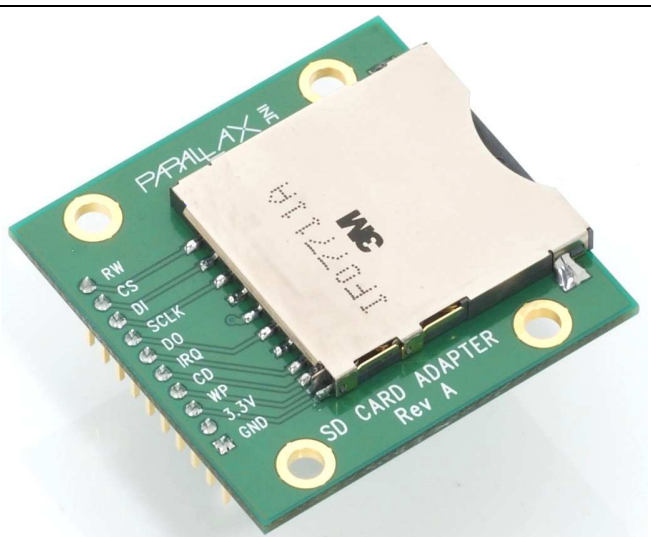

Quick Start Circuit

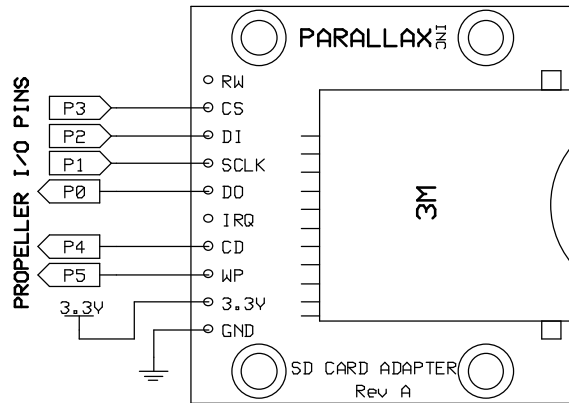

Connecting and Testing

Connect the pins above to the specified I/O pins on your Propeller Demo Board (#32100), Propeller Education Kit (#32305 or #32306), Propeller Proto Board (#32212 or #32812), Professional Development Board (#32111), PropRPM Board (#32202) or any other Propeller system or microcontroller capable of accessing the SD card. By using the I/O pins (P0-P3) listed above you can use the FSRW object available on the Propeller Object Exchange to test access to FAT formatted micro-SD cards with this adapter. P4 and P5 are optional connections for detecting a card (CD) and determining if the write protect switch (WP) is set or not.

Downloads and Resources

You can obtain the Propeller Tool software from the Downloads link at <http://www.parallax.com/propeller>
 You can obtain additional objects by visiting the object exchange at <http://obex.parallax.com>

Pin Definitions and Ratings

Pin	Name	Function
1	GND	Ground → 0V
2	3.3V	Power Supply → 3.3V
3	WP	Write Protect Switch (Low = Write Protect Switch Off)
4	CD	Card Detect Switch (Low = Card Present)
5	DAT1 / IRQ	Used in SDIO mode
6	DAT0 / DO	Serial Data Output
7	CLK / SCLK	Synchronous Clock Input
8	CMD / DI	Serial Data Input
9	DAT3 / CS	Chip Select
10	DAT2 / RW	Used in SDIO mode

Communication Protocol

This adapter is designed to support SPI mode, however all I/O lines from the SD card are brought out to support SD Bus Mode if you should want to use that connection method instead.

Module Dimensions

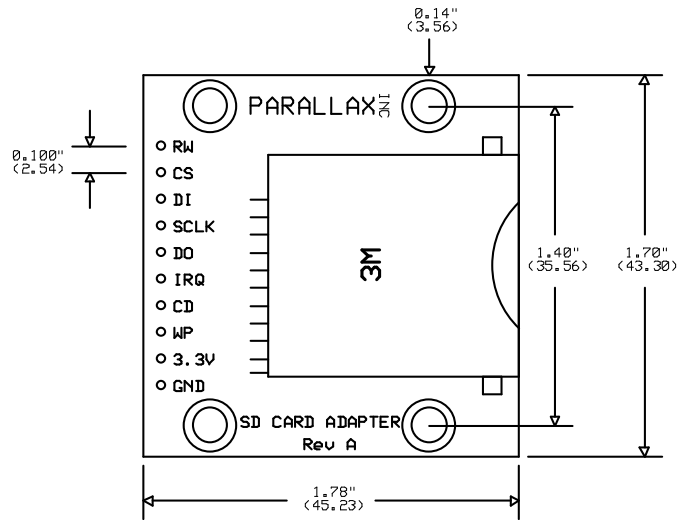
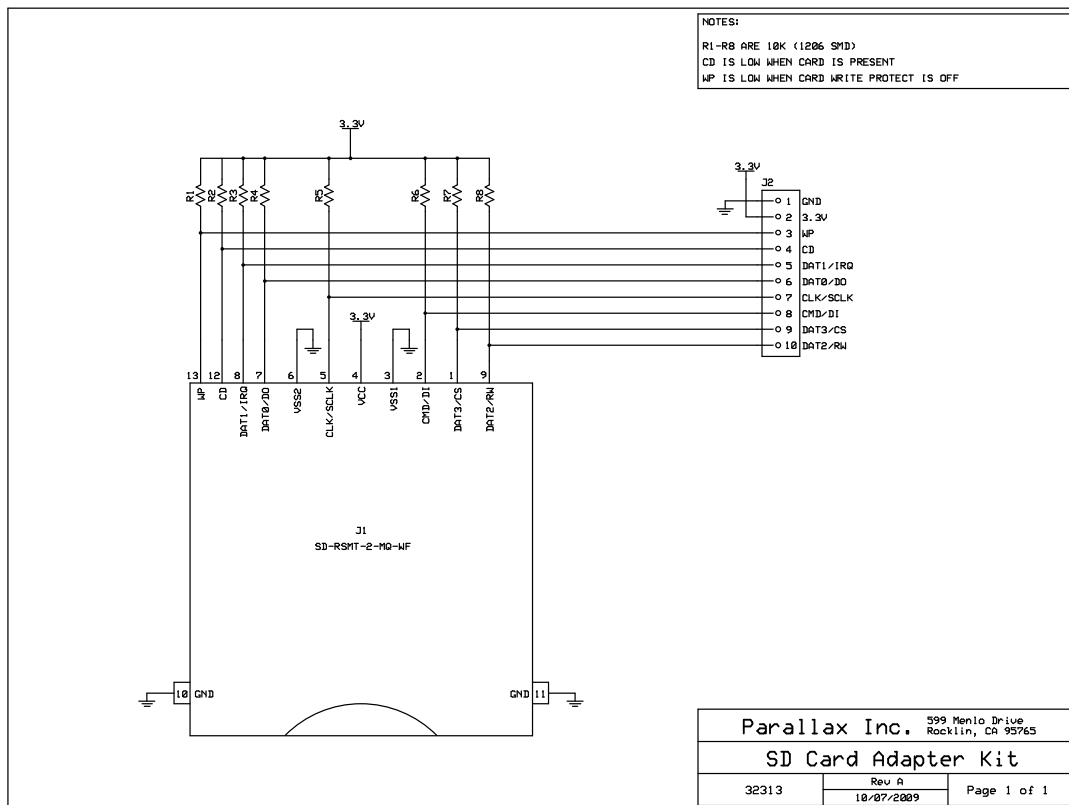

Figure 2: Module Dimensions

Module Schematic



Mouser Electronics

Authorized Distributor

Click to View Pricing, Inventory, Delivery & Lifecycle Information:

[Parallax:](#)

[32313](#)