

## RV Coaxial Switch

# 85% smaller\*

\*Compared PIN type RV coaxial switch with existing product (RD coaxial switch).

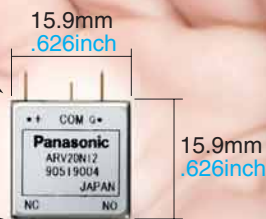

Failsafe type  
now available

PIN type  
SMA type  
(to 26.5GHz, Max. 50W at 3GHz)

New



PIN type



SMA type

## FEATURES

1. Compact size (Approx. 85% less volume compared to previous product.)\*  
PIN type size: L 15.9 × W 15.9 × H 11.2 mm L .626 × W .626 × H .441 inch
2. Excellent high frequency characteristics (to 8, 18, 26.5GHz, 50Ω)
3. Terminal shape options available (PIN and SMA)\*\*
4. Contact arrangement: SPDT
5. Failsafe type and latching type (2-coil latching type) that reduces operating power are now available.

\* Compared to previous product (RD coaxial switch) and PIN type RV coaxial switch.

\*\* For SMP connector type, please contact us.

## TYPICAL APPLICATIONS

- Compact wireless devices  
Compact measuring instrument  
All types of inspection equipment  
Digital broadcasting
- Broadcasting relay station
  - Broadcasting equipment
- Mobile communication
- Cellular phone base station

- 1) If you consider using applications requiring frequent switching or high number of operations, please contact us.
- 2) If you consider using applications with low level load, please contact us.

Compliance with RoHS Directive

## HIGH FREQUENCY CHARACTERISTICS (Impedance 50Ω, Initial)

### 1. PIN type

Frequency	to 4 GHz	4 to 8 GHz	8 to 12.4 GHz*	12.4 to 18 GHz*
V.S.W.R. (max.)	1.3	1.4	1.5	1.7
Insertion loss (dB. max.)	0.3	0.4	0.5	0.7
Isolation (dB. min.)	70	60	50	40

Note: \*8 to 18GHz characteristics can be applied 18GHz type only.

### 2. SMA type

Frequency	to 8 GHz	8 to 12.4 GHz*	12.4 to 18 GHz*	18 to 26.5 GHz**
V.S.W.R. (max.)	1.35	1.6	1.7	1.8
Insertion loss (dB. max.)	0.3	0.5	0.7	0.8
Isolation (dB. min.)	70	60	60	50

Note: \*8 to 18GHz characteristics can be applied 18GHz type and 26.5GHz type only.

\*\*18 to 26.5GHz characteristics can be applied 26.5GHz type only.

## ORDERING INFORMATION

ARV

Frequency

1: to 8GHz

2: to 18GHz

3: to 26.5GHz (SMA type only)

Operating function

0: Failsafe type/Standard contact

2: Latching type/Standard contact

3: Failsafe type/Reverse contact

Terminal shape

N: PIN type

A: SMA type

Nominal operating voltage

4H: 4.5 V DC

12: 12 V DC

24: 24 V DC

Operation terminal

Nil: Solder terminal

HF data attached

Nil: No HF test data attached

Q: HF test data attached (Displayed only on inner and outer packaging)

\*Please inquire regarding use with nominal operating voltage of 28 V DC.

## TYPES

## SPDT

Operating function	Contact terminal shape	Nominal operating voltage	to 8 GHz type		to 18 GHz type		to 26.5 GHz type	
			No HF datasheet attached	HF datasheet attached	No HF datasheet attached	HF datasheet attached	No HF datasheet attached	HF datasheet attached
Failsafe type/ Standard contact	PIN type	4.5 V DC	ARV10N4H	ARV10N4HQ	ARV20N4H	ARV20N4HQ	–	–
		12 V DC	ARV10N12	ARV10N12Q	ARV20N12	ARV20N12Q	–	–
		24 V DC	ARV10N24	ARV10N24Q	ARV20N24	ARV20N24Q	–	–
	SMA type	4.5 V DC	ARV10A4H	ARV10A4HQ	ARV20A4H	ARV20A4HQ	ARV30A4H	ARV30A4HQ
		12 V DC	ARV10A12	ARV10A12Q	ARV20A12	ARV20A12Q	ARV30A12	ARV30A12Q
		24 V DC	ARV10A24	ARV10A24Q	ARV20A24	ARV20A24Q	ARV30A24	ARV30A24Q
Latching type/ Standard contact	PIN type	4.5 V DC	ARV12N4H	ARV12N4HQ	ARV22N4H	ARV22N4HQ	–	–
		12 V DC	ARV12N12	ARV12N12Q	ARV22N12	ARV22N12Q	–	–
		24 V DC	ARV12N24	ARV12N24Q	ARV22N24	ARV22N24Q	–	–
	SMA type	4.5 V DC	ARV12A4H	ARV12A4HQ	ARV22A4H	ARV22A4HQ	ARV32A4H	ARV32A4HQ
		12 V DC	ARV12A12	ARV12A12Q	ARV22A12	ARV22A12Q	ARV32A12	ARV32A12Q
		24 V DC	ARV12A24	ARV12A24Q	ARV22A24	ARV22A24Q	ARV32A24	ARV32A24Q
Failsafe type/ Reverse contact	PIN type	4.5 V DC	ARV13N4H	ARV13N4HQ	ARV23N4H	ARV23N4HQ	–	–
		12 V DC	ARV13N12	ARV13N12Q	ARV23N12	ARV23N12Q	–	–
		24 V DC	ARV13N24	ARV13N24Q	ARV23N24	ARV23N24Q	–	–
	SMA type	4.5 V DC	ARV13A4H	ARV13A4HQ	ARV23A4H	ARV23A4HQ	ARV33A4H	ARV33A4HQ
		12 V DC	ARV13A12	ARV13A12Q	ARV23A12	ARV23A12Q	ARV33A12	ARV33A12Q
		24 V DC	ARV13A24	ARV13A24Q	ARV23A24	ARV23A24Q	ARV33A24	ARV33A24Q

Standard packing: Carton: 5 pcs. Case: 50 pcs.

## RATING

## 1. Coil data

## 1) Failsafe type (Standard contact and Reverse contact)

Nominal operating voltage	Pick-up voltage (at 20°C 68°F)	Drop-out voltage (at 20°C 68°F)	Nominal operating current [±10%] (at 20°C 68°F)	Coil resistance [±10%] (at 20°C 68°F)	Nominal operating power	Max. applied voltage (at 85°C 185°F)
4.5 V DC	75%V or less of nominal voltage*1 (Initial)	10%V or more of nominal voltage*1 (Initial)	155.7mA	28.9Ω	700mW	110%V of nominal voltage
12 V DC			58.3mA	205.7Ω		
24 V DC			29.2mA	822.9Ω		

## 2) Latching type (Standard contact)

Nominal operating voltage	Set voltage (at 20°C 68°F)	Reset voltage (at 20°C 68°F)	Nominal operating current [±10%] (at 20°C 68°F)	Coil resistance [±10%] (at 20°C 68°F)	Nominal operating power	Max. applied voltage (at 85°C 185°F)
4.5 V DC	75%V or less of nominal voltage*1 (Initial)	75%V or less of nominal voltage*1 (Initial)	155.7mA	28.9Ω	700mW	110%V of nominal voltage
12 V DC			58.3mA	205.7Ω		
24 V DC			29.2mA	822.9Ω		

Notes: \*1. Pulse drive (JIS C5442)

\*2. Please inquire regarding use with nominal operating voltage of 28 V DC.

# RV (ARV)

## 2. Specifications

Characteristics	Item	Specifications							
Contact	Arrangement	SPDT							
	Contact material	Gold plating							
	Contact resistance (Initial)	Max. 100mΩ (By voltage drop 10V AC 10mA)							
Rating	Contact input power (CW)	Max. 50W (at 3GHz) (V.S.W.R. 1.3 or less, no contact switching, ambient temperature 20°C 68°F)*1							
	Nominal operating power	700mW							
High frequency characteristics (Impedance 50Ω)		PIN type*2				SMA type			
	Frequency	to 4 GHz	4 to 8 GHz	8 to 12.4 GHz*3	12.4 to 18 GHz*3	to 8 GHz	8 to 12.4 GHz*4	12.4 to 18 GHz*4	18 to 26.5 GHz*5
	V.S.W.R. (max.)	1.3	1.4	1.5	1.7	1.35	1.6	1.7	1.8
	Insertion loss (dB, max.)	0.3	0.4	0.5	0.7	0.3	0.5	0.7	0.8
	Isolation (dB, min.)	70	60	50	40	70	60	60	50
Electrical characteristics	Insulation resistance (Initial)		Min. 1,000 MΩ (at 500 V DC) Measurement at same location as "breakdown voltage (Initial)" section.						
	Breakdown voltage (Initial)	Between open contacts	500 Vrms for 1 min. (Detection current: 10mA)						
		Between contact and earth terminal	500 Vrms for 1 min. (Detection current: 10mA)						
		Between contact and coil	500 Vrms for 1 min. (Detection current: 10mA)						
	Between coil and earth terminal	500 Vrms for 1 min. (Detection current: 10mA)							
Time characteristics (at 20°C 68°F)	Operate time (Set time)		Max. 15ms (approx. 5ms) (Nominal operating voltage applied to the coil, excluding contact bounce time.)						
	Release time (Reset time)		Max. 15ms (approx. 5ms) (Nominal operating voltage applied to the coil, excluding contact bounce time.) (without diode, only for Release time)						
Mechanical characteristics	Shock resistance	Functional	Min. 500 m/s <sup>2</sup> (Half-wave pulse of sine wave: 11ms, detection time: 10μs.)						
		Destructive	Min. 1,000 m/s <sup>2</sup> (Half-wave pulse of sine wave: 6ms.)						
	Vibration resistance	Functional	10 to 55 Hz at double amplitude of 3mm (Detection time: 10μs.)						
		Destructive	10 to 55 Hz at double amplitude of 5mm/15 to 2,000 Hz [W0 = 2.94 (m/s <sup>2</sup> ) <sup>2</sup> /Hz]						
Expected life	Mechanical		Min. 10 <sup>6</sup> (at 180 cpm)						
	Electrical (Hot switch)		Min. 3 × 10 <sup>5</sup> (1W High frequency load, at 3GHz, impedance 50Ω, V.S.W.R.; max. 1.3) (at 20 cpm)						
Conditions	Conditions for operation, transport and storage*6		Ambient temperature: -55°C to +85°C <del>-67°F</del> to +185°F Humidity: 5 to 85% R.H. (Not freezing and condensing at low temperature) Air pressure: 86 to 106 kPa						
Unit weight	PIN type: Approx. 12g <a href="#">.42oz</a>				SMA type: Approx. 20g <a href="#">.71oz</a>				

Notes: \*1. Factors such as heating of the connected terminal influence the high frequency characteristics; therefore, please verify under actual conditions of use.

\*2. Measuring method: After installing on dedicated inspection equipment

\*3. 8 to 18GHz characteristics can be applied 18GHz type only.

\*4. 8 to 18GHz characteristics can be applied 18GHz and 26.5GHz types only.

\*5. 18 to 26.5GHz characteristics can be applied 26.5GHz type only.

\*6. The upper operation ambient temperature limit is the maximum temperature that can satisfy the coil temperature rise value. Refer to "NOTES".

## REFERENCE DATA

### 1-(1). High frequency characteristics (PIN type)

Sample: ARV22N12

Measuring method: Measured with Agilent Technologies network analyzer (E8363B) after installing on dedicated inspection equipment.

• V.S.W.R.

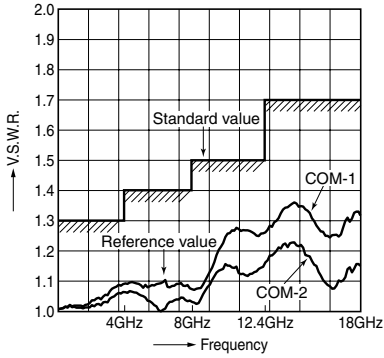

• Insertion loss

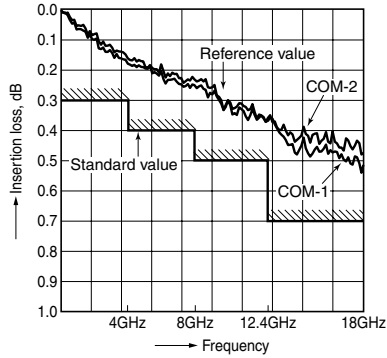

• Isolation

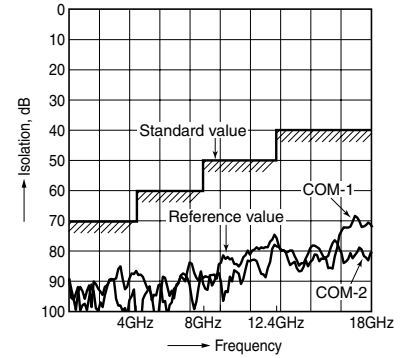

### 1-(2). High frequency characteristics (SMA type)

Sample: ARV32A12

Measuring method: Measured with Agilent Technologies network analyzer (E8363B).

• V.S.W.R.

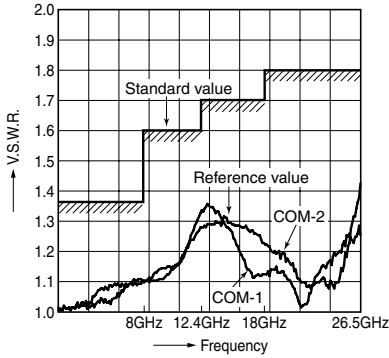

• Insertion loss

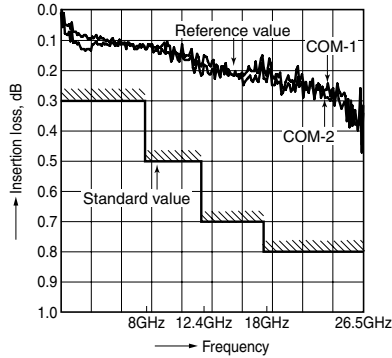

• Isolation

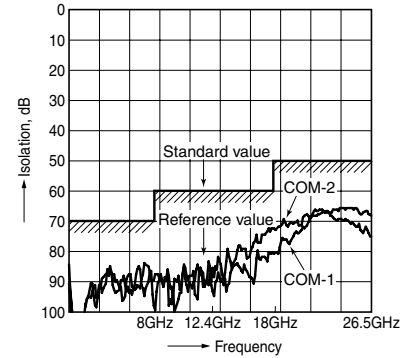

# RV (ARV)

## DIMENSIONS (mm inch)

The CAD data of the products with a **CAD Data** mark can be downloaded from: <http://panasonic-electric-works.net/ac>

### 1. PIN type

**CAD Data**



The part number depend on the type and voltage.

Lot number

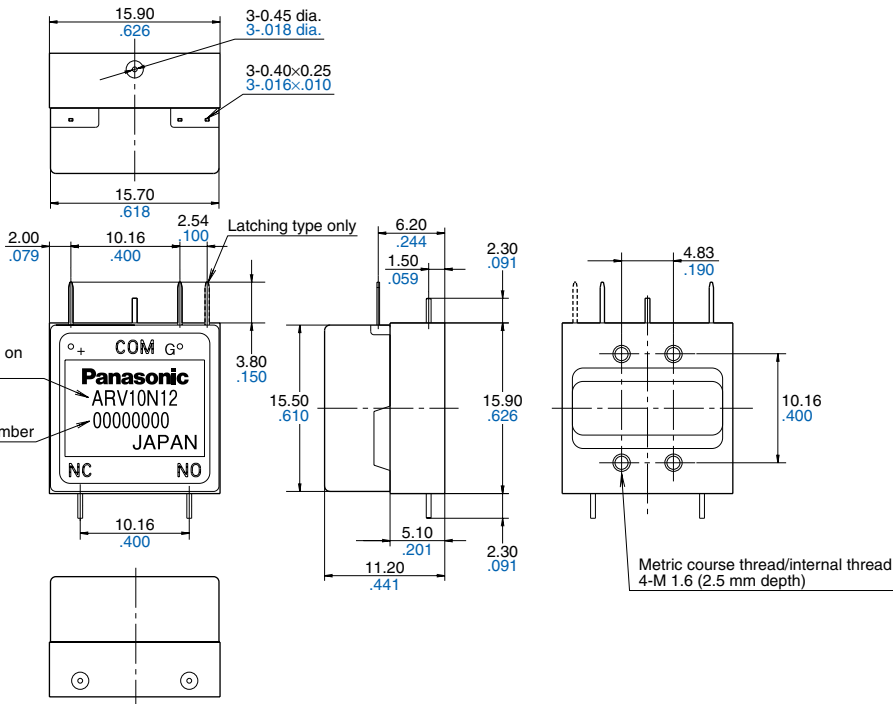

Tolerance:  $\pm 0.3 \pm 0.12$

### Schematic (Top view)

<Standard contact>  
Failsafe type  
(Deenergized condition)

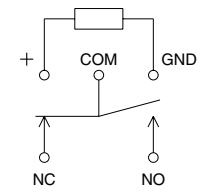

Latching type  
(Reset condition)

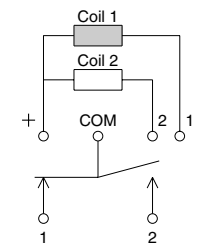

<Reverse contact>  
Failsafe type  
(Deenergized condition)

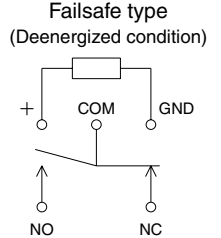

### 2. SMA type

**CAD Data**



The part number depend on the type and voltage.

Lot number

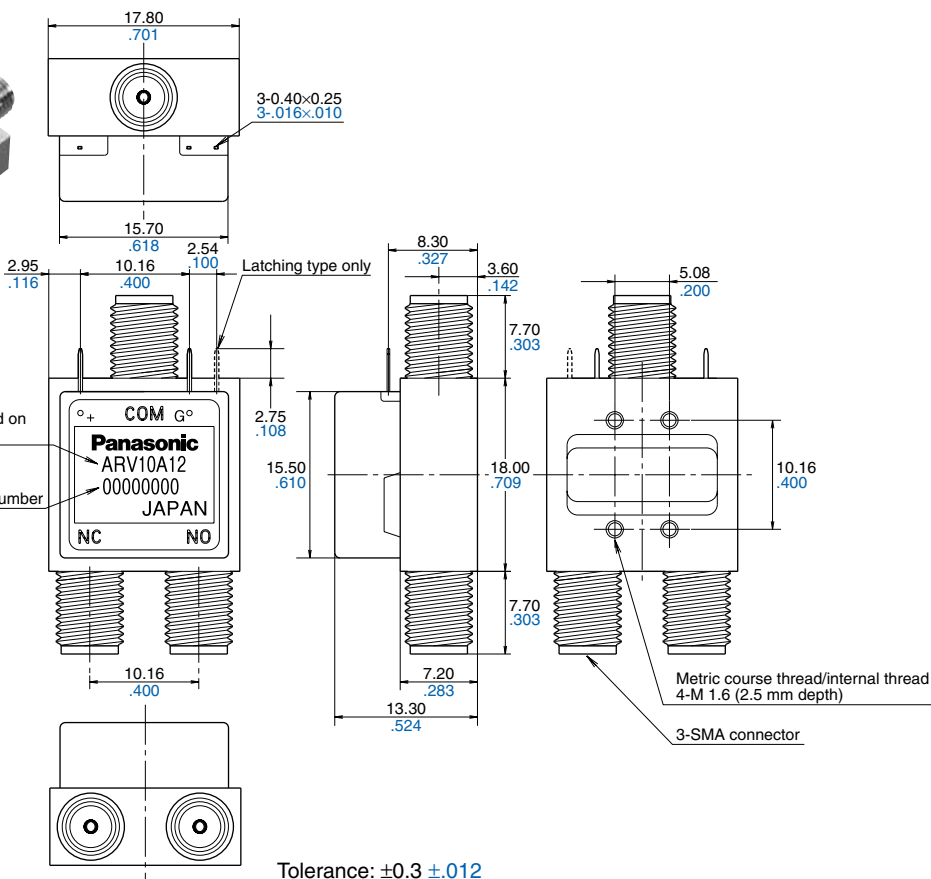

Tolerance:  $\pm 0.3 \pm 0.12$

### Schematic (Top view)

<Standard contact>  
Failsafe type  
(Deenergized condition)

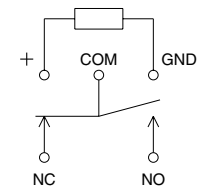

Latching type  
(Reset condition)

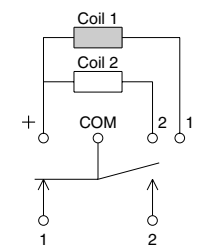

<Reverse contact>  
Failsafe type  
(Deenergized condition)

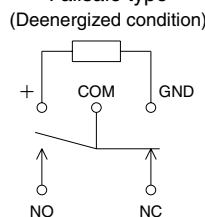

\*For SMP connector type, please consult us.

## NOTES

1. For general cautions for use, please refer to the “General Application Guidelines”.

### 2. Coil operating power

Pure DC current should be applied to the coil. The wave form should be rectangular. If it includes ripple, the ripple factor should be less than 5%.

However, check it with the actual circuit since the characteristics may be slightly different. The nominal operating voltage should be applied to the coil for more than 50 ms to set/reset the latching type. Please use the latching type for circuits that are continually powered for long periods of time.

### 3. Coil connection

Since this product is polarized, please be aware of the plus/minus polarity of the coil.

### 4. Connection and washing conditions for coil and PIN type contact terminals

1) The connection of coil and PIN type contact terminals shall be done by soldering.

Soldering conditions

Max. 260°C 500°F (solder temp) within 10sec (soldering time)

Max. 350°C 662°F (solder temp) within 3sec (soldering time)

2) This product is not sealed type, therefore washing is not allowed.

### 5. Conditions for operation, transport and storage conditions

1) Temperature:

–55 to +85°C –67 to +185°F

2) Humidity: 5 to 85% RH

(Avoid freezing and condensation.)

The humidity range varies with the temperature. Use within the range indicated in the graph below.

3) Atmospheric pressure: 86 to 106 kPa  
Temperature and humidity range for usage, transport, and storage:

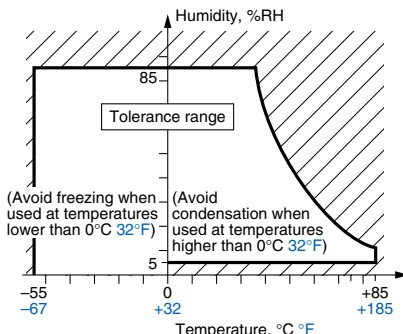

### 4) Condensation

Condensation forms when there is a sudden change in temperature under high temperature and high humidity conditions. Condensation will cause deterioration of coaxial switch insulation.

### 5) Freezing

Condensation or other moisture may freeze on coaxial switch when the temperature is lower than 0°C 32°F. This causes problems such as sticking of movable parts or operational time lags.

### 6) Low temperature, low humidity environments.

The plastic may become brittle if coaxial switch is exposed to a low temperature, low humidity environment for long periods of time.

### 6. Other handling precautions.

1) Coaxial switch's on/off service life is based on standard test conditions (temperature: 15 to 35°C 59 to 95°F, humidity: 25 to 75%) specified in JIS C5442-1996. Life will depend on many factors of your system: coil drive circuit, type of load, switching intervals, switching phase, ambient conditions, to name a few.

2) Use coaxial switch within specifications such as coil rating, contact rating and on/off service life. If used beyond limits, coaxial switch may overheat, generate smoke or catch fire.

3) Be careful not to drop coaxial switch. If accidentally dropped, carefully check its appearance and characteristics before use.

4) Be careful to wire coaxial switch correctly. Otherwise, malfunction, overheat, fire or other trouble may occur.

5) The latching type product is shipped in the reset position. But jolts during transport or impacts during installation can move it to the set position. It is, therefore, advisable to build a circuit in which coaxial switch can be initialized (set and reset) just after turning on the power.

6) If coaxial switch stays on in a circuit for many months or years at a time without being activated, circuit design should be reviewed so that the coaxial switch can remain deenergized. A coil that receives current all the time heats, which degrades insulation earlier than expected. A latching type is recommended for such circuits.

7) For SMA connectors (SMA type only), we recommend a torque of 0.90±0.1 N·m for installation, which falls within the prescribed torque of MIL-C-39012.

Please be aware that conditions might be different depending on the connector materials and how it interacts with surrounding materials.

8) Please do not use silicon based substances such as silicon rubber, silicon oil, silicon coatings and silicon fillings, in the vicinity of the coaxial switch. Doing so may cause volatile silicon gas to form which may lead to contact failure due to the adherence of silicon on the contacts when they open and close in this atmosphere.

9) In order to ensure stable signal communication on contact, it is recommended that the monitoring of contact signal should be started from Min. 100 ms after coil rated voltage is applied.

# Mouser Electronics

Authorized Distributor

Click to View Pricing, Inventory, Delivery & Lifecycle Information:

## Panasonic:

[ARV23A24Q](#) [ARV23A4H](#) [ARV23A4HQ](#) [ARV23N12](#) [ARV23N12Q](#) [ARV23N24](#) [ARV23N24Q](#) [ARV23N4H](#)  
[ARV23N4HQ](#) [ARV30A12](#) [ARV30A12Q](#) [ARV30A24](#) [ARV30A24Q](#) [ARV30A4H](#) [ARV30A4HQ](#) [ARV32A12](#)  
[ARV32A12Q](#) [ARV32A24](#) [ARV32A24Q](#) [ARV32A4H](#) [ARV32A4HQ](#) [ARV33A12](#) [ARV33A12Q](#) [ARV33A24](#)  
[ARV33A24Q](#) [ARV33A4H](#) [ARV33A4HQ](#)