

# 6-lead in-line MULTILED Enhanced optical Power LED (ThinFilm / ThinGaN) Lead (Pb) Free Product - RoHS Compliant

## LRTB GFTG



## Released

### Besondere Merkmale

- **Gehäusotyp:** weißes P-LCC-6 Gehäuse, Kontrasterhöhung durch schwarze Oberfläche (RGB-Displays) und diffuser Silikon-Verguß
- **Besonderheit des Bauteils:** additive Farbmischung durch unabhängige Ansteuerung aller Chips
- **Wellenlänge:** 625 nm (red), 528 nm (true green), 470 nm (blau)
- **Abstrahlwinkel:** Lambertischer Strahler (120°)
- **Technologie:** ThinFilm (rot), ThinGaN (true grün, blau)
- **optischer Wirkungsgrad:** 45 lm/W (rot), 50 lm/W (true grün), 11 lm/W (blau)
- **Gruppierungsparameter:** Lichtstärke, Wellenlänge
- **Verarbeitungsmethode:** für alle SMT-Bestücktechniken geeignet
- **Lötmethode:** Reflow Löten
- **Vorbehandlung:** nach JEDEC Level 4
- **Gurtung:** 12 mm Gurt mit 1000/Rolle, ø180 mm oder 4000/Rolle, ø330 mm
- **ESD-Festigkeit:** ESD-sensitives Bauteil

### Anwendungen

- Anzeigen im Innen- und Außenbereich (z.B. im Verkehrsbereich; Laufschriftanzeigen)
- Getrennte Antsteuerung der Leuchtdiodenchips zur Darstellung verschiedener Farben inklusive weiß
- Vollfarbdisplays bzw. RGB-Displays

### Features

- **package:** white P-LCC-6 package, higher contrast by a black surface (RGB-Displays) and diffused silicone resin
- **feature of the device:** additive mixture of color stimuli by independent driving of each chip
- **wavelength:** 625 nm (red), 528 nm (true green), 470 nm (blue)
- **viewing angle:** Lambertian Emitter (120°)
- **technology:** ThinFilm (red), ThinGaN (true green, blue)
- **optical efficiency:** 45 lm/W (red), 50 lm/W (true green), 11 lm/W (blue)
- **grouping parameter:** luminous intensity, wavelength
- **assembly methods:** suitable for all SMT assembly methods
- **soldering methods:** reflow soldering
- **preconditioning:** acc. to JEDEC Level 4
- **taping:** 12 mm tape with 1000/reel, ø180 mm or 4000/reel, ø330 mm
- **ESD-withstand voltage:** ESD sensitive device

### Applications

- indoor and outdoor displays (e.g. displays for traffic; light writing displays)
- LED chips can be controlled separately to display various colors including white
- full color displays, RGB-Displays

**Bestellinformation**  
**Ordering Information**

Typ Type	Emissionsfarbe Color of Emission	Lichtstärke <sup>1)</sup> Seite 25 Luminous Intensity <sup>1)</sup> page 25		
		$I_F = 20 \text{ mA}$ $I_V \text{ (mcd)}$		
		red	true green	blue
LRTB GFTG	red true green blue	355 ... 1800	900 ... 2240	125 ... 630

**Bestellinformation**  
**Ordering Information**

Typ Type	Bestellnummer Ordering Code
LRTB GFTG-T7AW-1+V7A7-29+R5T9-49-L	Q65110A8177
LRTB GFTG-T7AW-1+V7A7-29+R5T9-49-S	Q65110A9105

Anm: Die oben genannten Typbezeichnungen umfassen die bestellbaren Selektionen. Diese bestehen aus wenigen Helligkeitsgruppen (siehe **Seite 7** für nähere Informationen). Es wird nur eine einzige Helligkeitsgruppe pro Gurt geliefert. Z.B.: LRTB GFTG-T7AW-1+V7A7-29+R5T9-49-L bedeutet, dass auf dem Gurt nur eine der Helligkeitsgruppen T7, T9, U, U5, U7, U9, V, V5, V7, V9 oder AW enthalten ist. Um die Liefersicherheit zu gewährleisten, können einzelne Helligkeitsgruppen nicht bestellt werden.

Gleiches gilt für die Farben, bei denen Wellenlängengruppen gemessen und gruppiert werden. Pro Gurt wird nur eine Wellenlängengruppe geliefert. Z.B.: LRTB GFTG-T7AW-1+V7A7-29+R5T9-49-L bedeutet, dass auf dem Gurt nur eine der Wellenlängengruppen -2, -3, -4, -5, -6, -7, -8 oder -9 enthalten ist (siehe **Seite 8** für nähere Information). Z.B.: LRTB GFTG-T7AW-1+V7A7-29+R5T9-49-L bedeutet, dass das Bauteil innerhalb der auf **Seite 4** spezifizierten Grenzen geliefert wird. Um die Liefersicherheit zu gewährleisten, können einzelne Wellenlängengruppen nicht bestellt werden.

LRTB GFTG-T7AW-1+V7A7-29+R5T9-49-L bedeutet Lieferung auf einer  $\varnothing 330 \text{ mm}$  Rolle.  
 LRTB GFTG-T7AW-1+V7A7-29+R5T9-49-S bedeutet Lieferung auf einer  $\varnothing 180 \text{ mm}$  Rolle.

Anm: The above Type Numbers represent the order groups which include only a few brightness groups (see **page 7** for explanation). Only one group will be shipped on each reel (there will be no mixing of two groups on each reel). E.g. LRTB GFTG-T7AW-1+V7A7-29+R5T9-49-L means that only one group T7, T9, U, U5, U7, U9, V, V5, V7, V9 oder AW will be shippable for any one reel. In order to ensure availability, single brightness groups will not be orderable.

In a similar manner for colors where wavelength groups are measured and binned, single wavelength groups will be shipped on any one reel. E.g. LRTB GFTG-T7AW-1+V7A7-29+R5T9-49-L means that only 1 wavelength group -2, -3, -4, -5, -6, -7, -8 or -9 will be shippable (see **page 8** for explanation). E.g. LRTB GFTG-T7AW-1+V7A7-29+R5T9-49-L means that the device will be shipped within the specified limits as stated on **page 4**. In order to ensure availability, single wavelength groups will not be orderable.

LRTB GFTG-T7AW-1+V7A7-29+R5T9-49-L means delivery on  $\varnothing 330 \text{ mm}$  reel.  
 LRTB GFTG-T7AW-1+V7A7-29+R5T9-49-S means delivery on  $\varnothing 180 \text{ mm}$  reel..

**Grenzwerte**  
**Maximum Ratings**

Bezeichnung Parameter	Symbol Symbol	Werte Values			Einheit Unit
		red	true green	blue	
Betriebstemperatur Operating temperature range	$T_{op}$	- 40 ... + 110			°C
Lagertemperatur Storage temperature range	$T_{stg}$	- 40 ... + 110			°C
Sperrschichttemperatur Junction temperature	$T_j$	+ 125			°C
Durchlassstrom (min.) Forward current (max.) ( $T_S=25^\circ\text{C}$ )	$I_F$	- 40	5 50	5 50	mA
Stoßstrom Surge current $t_p = 10 \mu\text{s}$ , $D = 0.005$ , $T_A=25^\circ\text{C}$	$I_{FM}$	100	300	300	mA
Sperrspannung <sup>2) Seite 25</sup> Reverse voltage <sup>2) page 25</sup> ( $T_A=25^\circ\text{C}$ )	$V_R$	12	5		V

## Kennwerte Characteristics

( $T_S = 25\text{ °C}$ )

Bezeichnung Parameter	Symbol Symbol	Werte Values			Einheit Unit
		red	true green	blue	
Wellenlänge des emittierten Lichtes Wavelength at peak emission $I_F = 20\text{ mA}$	(typ.) $\lambda_{\text{peak}}$	632	523	465	nm
Dominantwellenlänge <sup>4)</sup> Seite 25 Dominant wavelength <sup>4)</sup> page 25 $I_F = 20\text{ mA}$	(min.) $\lambda_{\text{dom}}$ (typ.) (max.)	619 625 631	519 528 546	459 470 476	nm nm nm
Spektrale Bandbreite bei 50 % $I_{\text{rel max}}$ Spectral bandwidth at 50 % $I_{\text{rel max}}$ $I_F = 20\text{ mA}$	(typ.) $\Delta\lambda$	18	33	25	nm
Abstrahlwinkel bei 50 % $I_V$ (Vollwinkel) Viewing angle at 50 % $I_V$	(typ.) $2\phi$	120	120	120	Grad deg.
Durchlassspannung <sup>5)</sup> Seite 25 Forward voltage <sup>5)</sup> page 25 $I_F = 20\text{ mA}$	(min.) $V_F$ (typ.) (max.) $V_F$	1.8 2.05 2.4	2.9 3.2 3.7	2.9 3.2 3.7	V V V
Sperrstrom Reverse current $V_R = 5\text{ V}$ (blue / true green); 12 V (red)	(typ.) $I_R$ (max.) $I_R$	0.02 10	0.01 10	0.01 10	$\mu\text{A}$ $\mu\text{A}$
Temperaturkoeffizient von $\lambda_{\text{peak}}$ Temperature coefficient of $\lambda_{\text{peak}}$ $I_F = 20\text{ mA}; -10\text{ °C} \leq T \leq 100\text{ °C}$	(typ.) $TC_{\lambda_{\text{peak}}}$	0.14	0.04	0.04	nm/K
Temperaturkoeffizient von $\lambda_{\text{dom}}$ Temperature coefficient of $\lambda_{\text{dom}}$ $I_F = 20\text{ mA}; -10\text{ °C} \leq T \leq 100\text{ °C}$	(typ.) $TC_{\lambda_{\text{dom}}}$	0.07	0.03	0.02	nm/K
Temperaturkoeffizient von $V_F$ Temperature coefficient of $V_F$ $I_F = 20\text{ mA}; -10\text{ °C} \leq T \leq 100\text{ °C}$	(typ.) $TC_V$	- 2.5	- 3.6	- 4.0	mV/K
Optischer Wirkungsgrad Optical efficiency $I_F = 20\text{ mA}$	(typ.) $\eta_{\text{opt}}$	45	50	11	lm/W
Wärmewiderstand Thermal resistance Sperrschicht/Umgebung <sup>3)</sup> Seite 25 Junction/ambient <sup>3)</sup> page 25 Sperrschicht/Löt看 Junction/solder point	1 chip on 3 chips on $R_{\text{th JA}}$ $R_{\text{th JA}}$ $R_{\text{th JS}}$	440 700 280**	340 600 180**	340 600 180**	K/W K/W K/W

\* Einzelgruppen siehe Seite 8  
Individual groups on page 8

\*\* $R_{\text{th}}$  (max) basiert auf statistischen Werten  
 $R_{\text{th}}$  (max) is based on statistic values

Farbortgruppen<sup>6)</sup> Seite 25

Chromaticity Coordinate Groups<sup>6)</sup> page 25

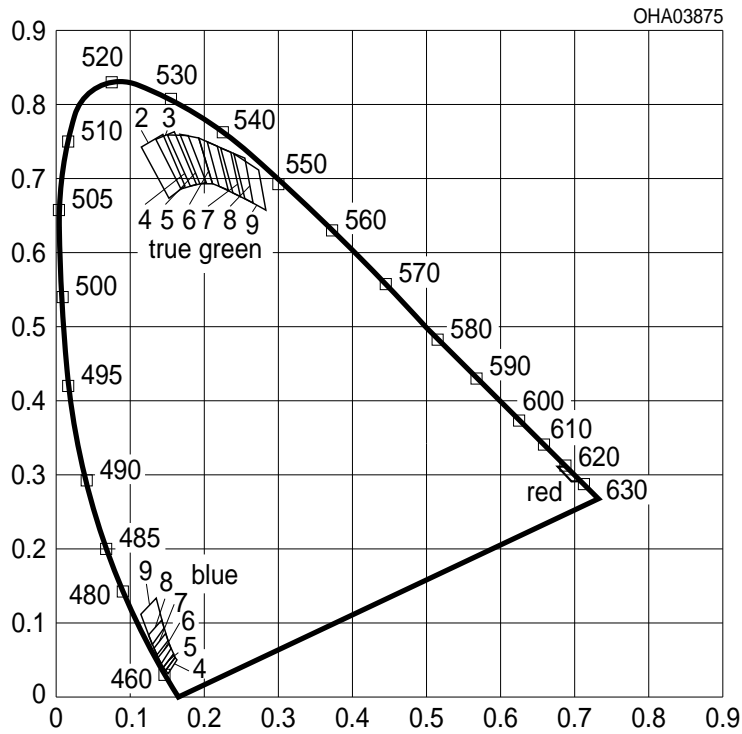

Gruppe Group	Cx	Cy	Gruppe Group	Cx	Cy
2	0.115	0.742	4	0.146	0.029
	0.152	0.673		0.157	0.047
	0.174	0.691		0.153	0.056
	0.144	0.760		0.140	0.037
3	0.134	0.754	5	0.143	0.033
	0.167	0.685		0.155	0.051
	0.188	0.692		0.150	0.062
	0.160	0.762		0.137	0.042
4	0.150	0.759	6	0.140	0.037
	0.180	0.689		0.153	0.056
	0.202	0.694		0.148	0.069
	0.179	0.757		0.133	0.048
5	0.166	0.760	7	0.137	0.042
	0.192	0.694		0.150	0.062
	0.222	0.690		0.143	0.083
	0.202	0.752		0.126	0.061
6	0.190	0.755	8	0.131	0.052
	0.212	0.691		0.146	0.073
	0.233	0.684		0.138	0.100
	0.215	0.745		0.119	0.078
7	0.203	0.750	9	0.125	0.067
	0.222	0.687		0.141	0.088
	0.249	0.676		0.130	0.130
	0.234	0.735		0.109	0.109
8	0.222	0.742	red	0.693	0.310
	0.238	0.681		0.679	0.311
	0.265	0.668		0.698	0.292
	0.253	0.727		0.712	0.291
9	0.240	0.734			
	0.254	0.674			
	0.283	0.657			
	0.274	0.710			

Anm.: Die Farbkoordinaten des Mischlichtes können innerhalb des gekennzeichneten Bereichs des Farbdreiecks erwartet werden.

Note: The color coordinates of the mixed light can be expected within the marked area of the color triangle

**Floating Bins**

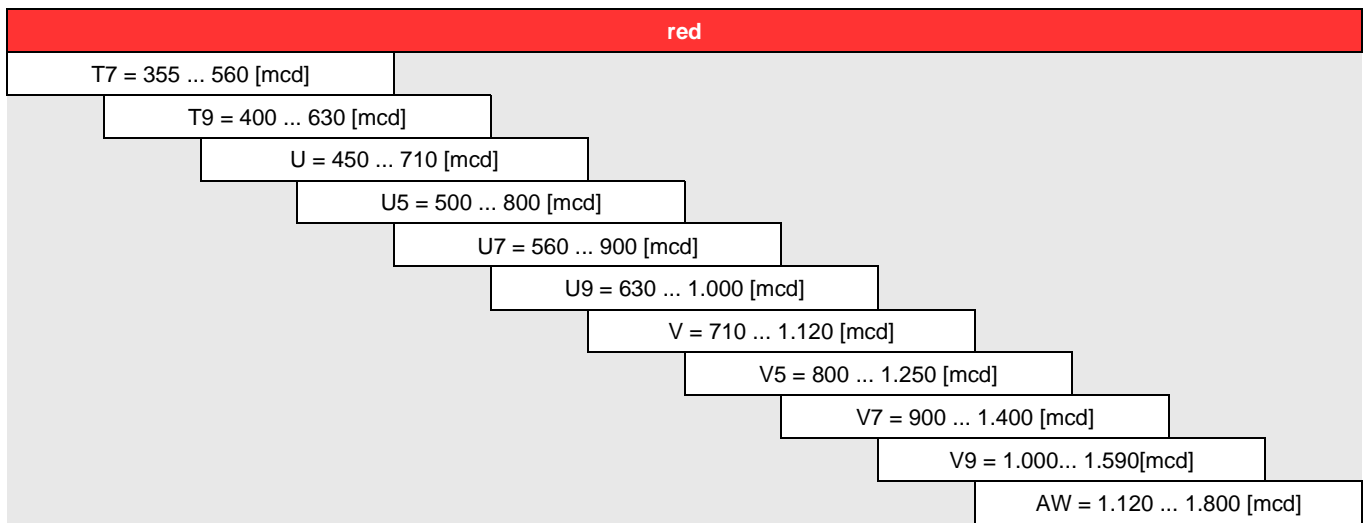

**Floating Bins**

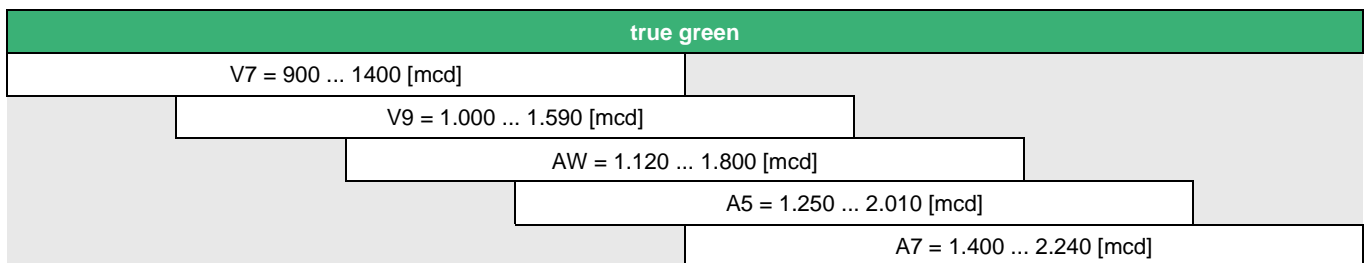

**Floating Bins**

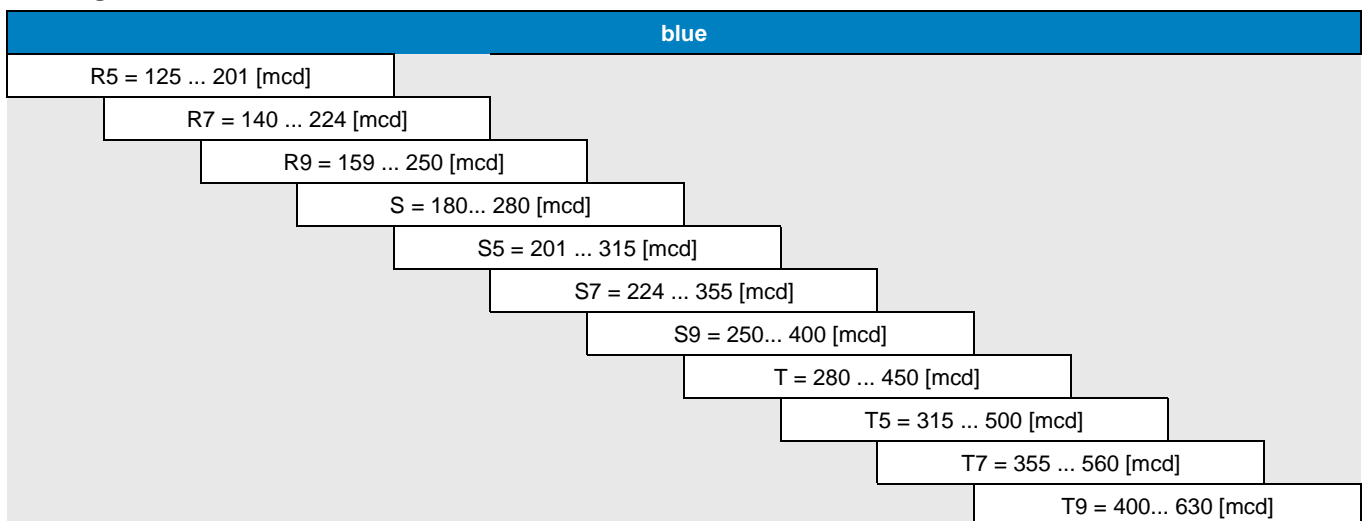

**Wellenlängengruppen (Dominantwellenlänge)<sup>4)</sup> Seite 25****Wavelength Groups (Dominant Wavelength)<sup>4)</sup> page 25**

Gruppe Group	true green		Einheit Unit
	min.	max.	
2	519	525	nm
3	523	528	nm
4	526	531	nm
5	529	535	nm
6	533	537	nm
7	535	540	nm
8	538	543	nm
9	541	546	nm

Gruppe Group	blue		Einheit Unit
	min.	max.	
4	459	463	nm
5	461	465	nm
6	463	467	nm
7	465	470	nm
8	468	473	nm
9	471	476	nm

**Gruppenbezeichnung auf Etikett****Group Name on Label**

Beispiel: T7-1+V7-2+R5-4

Example: T7-1+V7-2+R5-4

Helligkeits- gruppe	Wellenlänge (keine Gruppierung)	Helligkeits- gruppe	Wellenlänge	Helligkeits- gruppe	Wellenlänge
Brightness Group	Wavelength (no grouping)	Brightness Group	Wavelength	Brightness Group	Wavelength
(red)	(red)	(true green)	(true green)	(blue)	(blue)
T7	1	V7	2	R5	4

Anm.: In einer Verpackungseinheit / Gurt ist immer nur eine Helligkeitsgruppe pro Farbe enthalten.

Note: No packing unit / tape ever contains more than one brightness group per color.



Relative spektrale Emission<sup>6)</sup> Seite 25

Relative Spectral Emission<sup>6)</sup> page 25

$V(\lambda)$  = spektrale Augenempfindlichkeit / Standard eye response curve

$I_{rel} = f(\lambda); T_S = 25\text{ °C}; I_F = 20\text{ mA}$

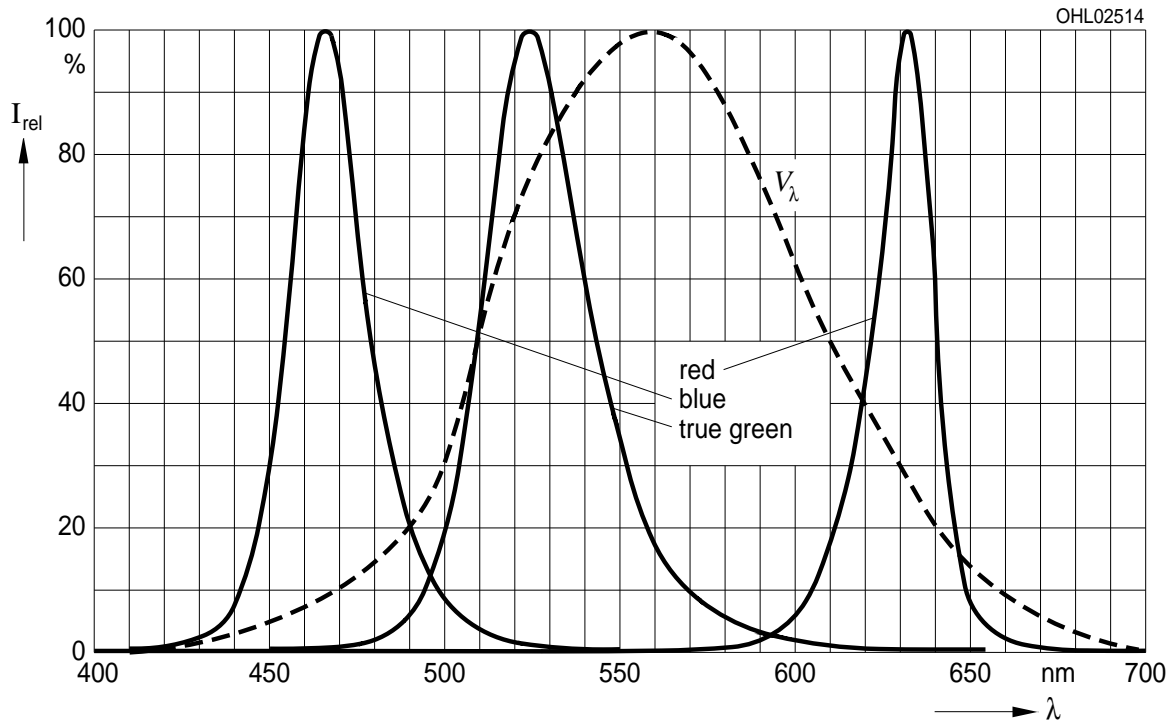

Abstrahlcharakteristik<sup>6)</sup> Seite 25

Radiation Characteristic<sup>6)</sup> page 25

$I_{rel} = f(\varphi)$ ;  $T_S = 25\text{ °C}$ ,  $I_F = 20\text{ mA (R)}$ ;  $20\text{ mA (T)}$ ;  $20\text{ mA (B)}$  red, true green, blue

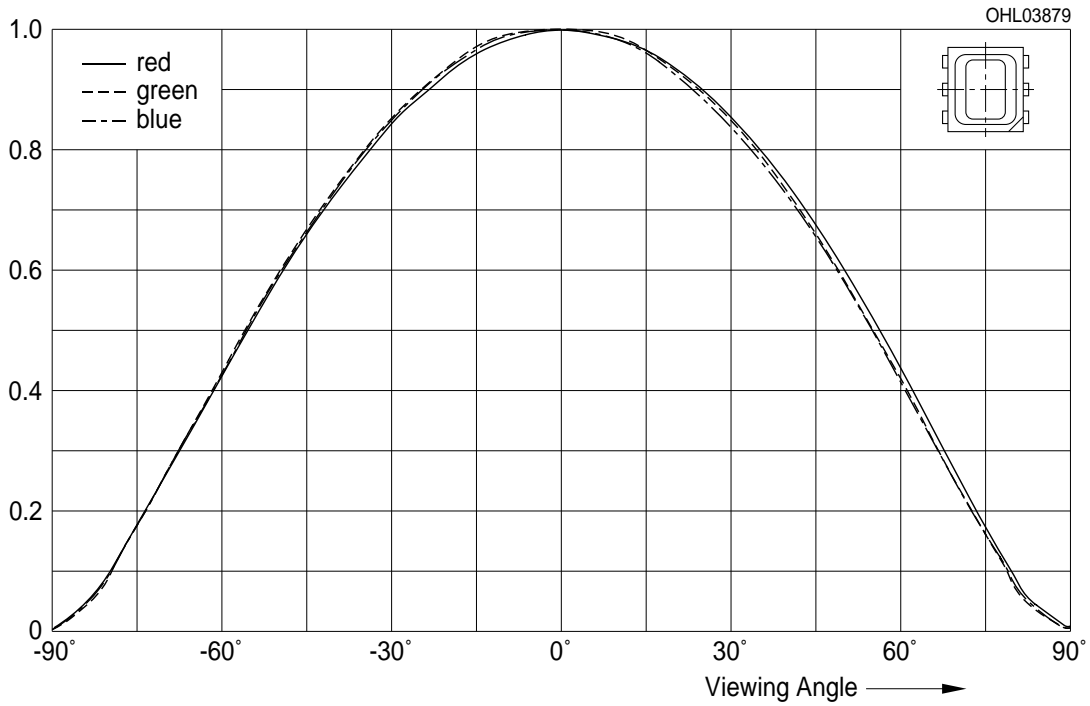

Abstrahlcharakteristik<sup>6)</sup> Seite 25

Radiation Characteristic<sup>6)</sup> page 25

$I_{rel} = f(\varphi)$ ;  $T_S = 25\text{ °C}$ ,  $I_F = 20\text{ mA (R)}$ ;  $20\text{ mA (T)}$ ;  $20\text{ mA (B)}$  red, true green, blue

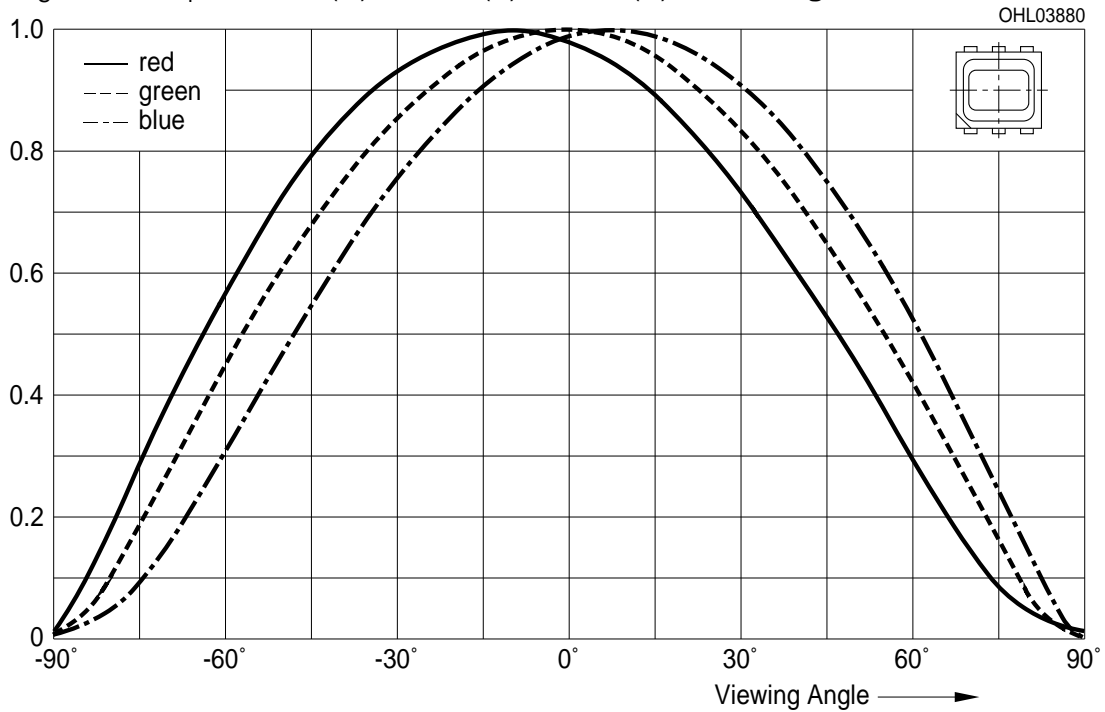

**Durchlassstrom**<sup>6) Seite 25</sup>

**Forward Current**<sup>6) page 25</sup>

$I_F = f(V_F); T_S = 25\text{ °C}$

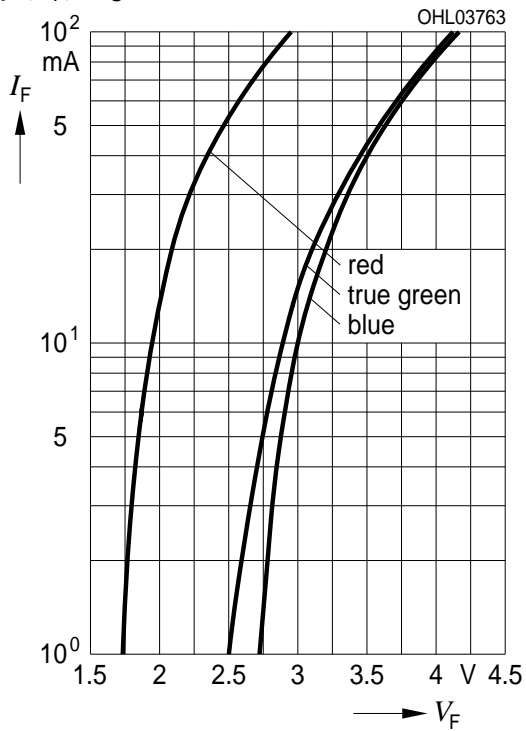

**Relative Lichtstärke**<sup>6) 7) Seite 25</sup>

**Relative Luminous Intensity**<sup>6) 7) page 25</sup>

$I_V/I_V(20\text{ mA}) = f(I_F); T_S = 25\text{ °C}$

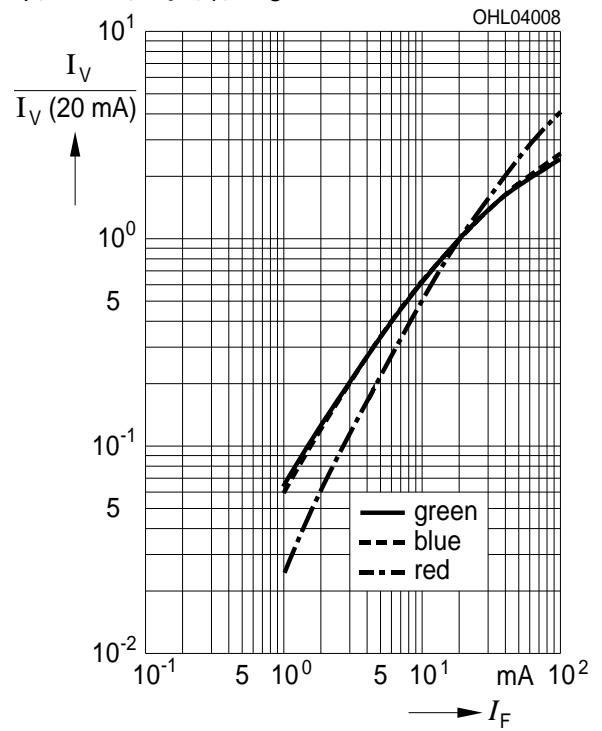

**Relative Lichtstärke**<sup>6) Seite 25</sup>

**Relative Luminous Intensity**<sup>6) page 25</sup>

$I_V/I_V(25\text{ °C}) = f(T_S); I_F = 20\text{ mA}$

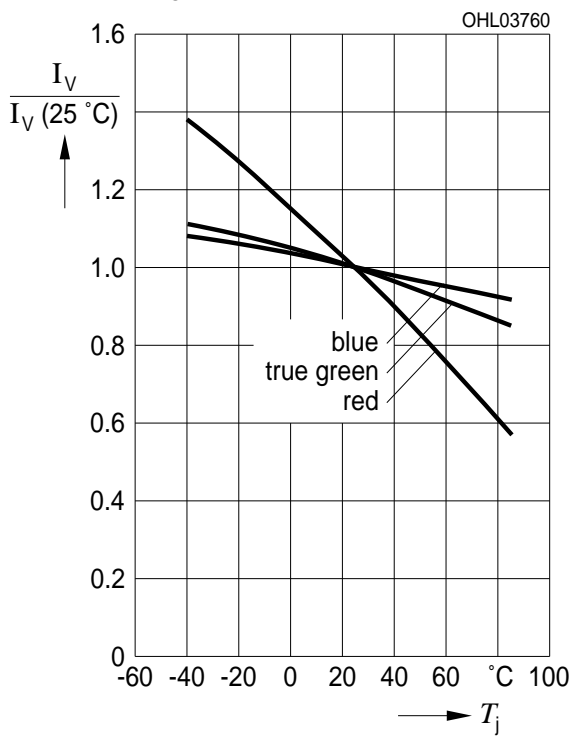

Dominante Wellenlänge<sup>6)</sup> Seite 25

Dominant Wavelength<sup>6)</sup> page 25

blue,  $\lambda_{\text{dom}} = f(I_F); T_S = 25 \text{ }^\circ\text{C}$

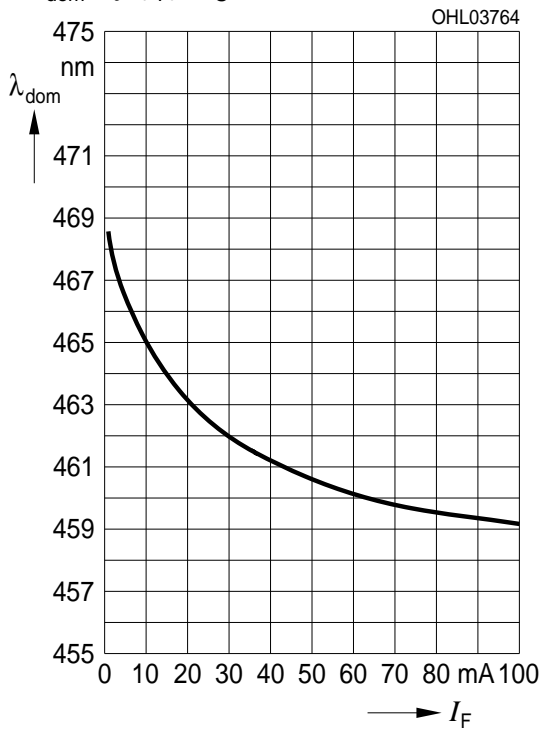

Dominante Wellenlänge<sup>6)</sup> Seite 25

Dominant Wavelength<sup>6)</sup> page 25

true green,  $\lambda_{\text{dom}} = f(I_F); T_S = 25 \text{ }^\circ\text{C}$

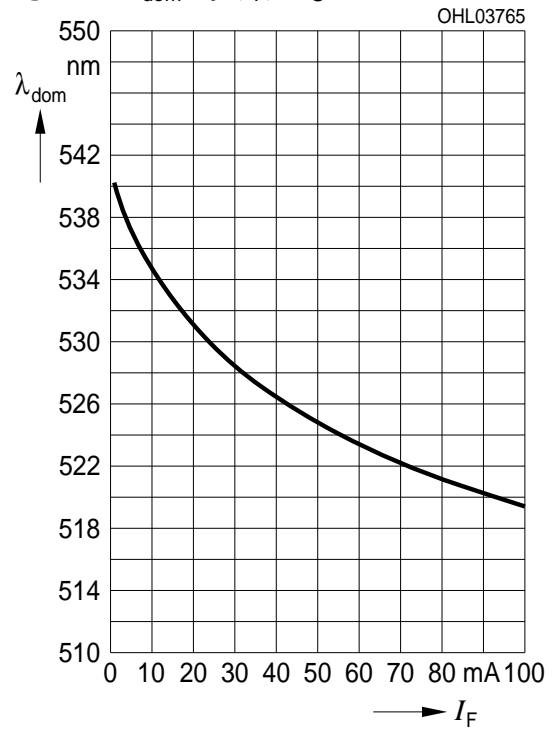

**Maximal zulässiger Durchlassstrom rot**  
**Max. Permissible Forward Current red**  
 $I_F = f(T)$ ; 1 chip on

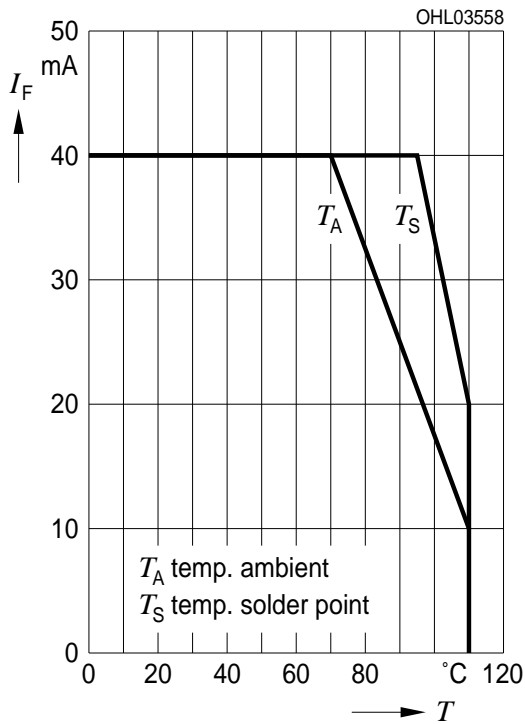

**Maximal zulässiger Durchlassstrom rot**  
**Max. Permissible Forward Current red**  
 $I_F = f(T)$ ; 3 chips on

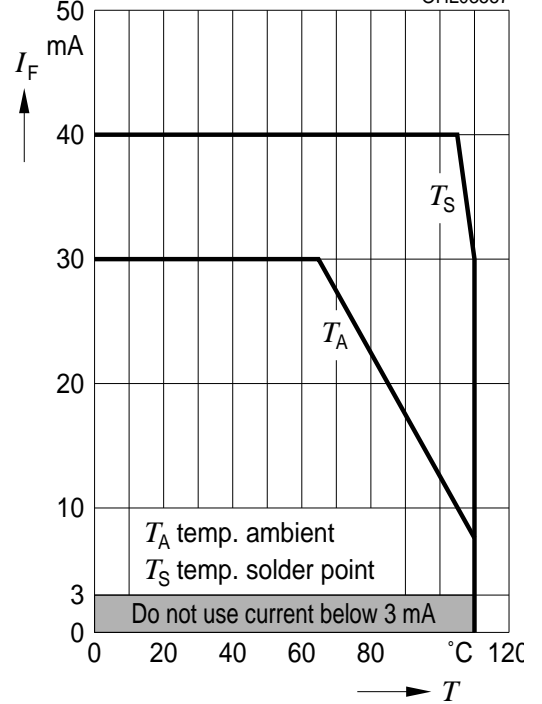

**Maximal zulässiger Durchlassstrom true grün**  
**Max. Permissible Forward Current true green**  
 $I_F = f(T)$ ; 1 chip on

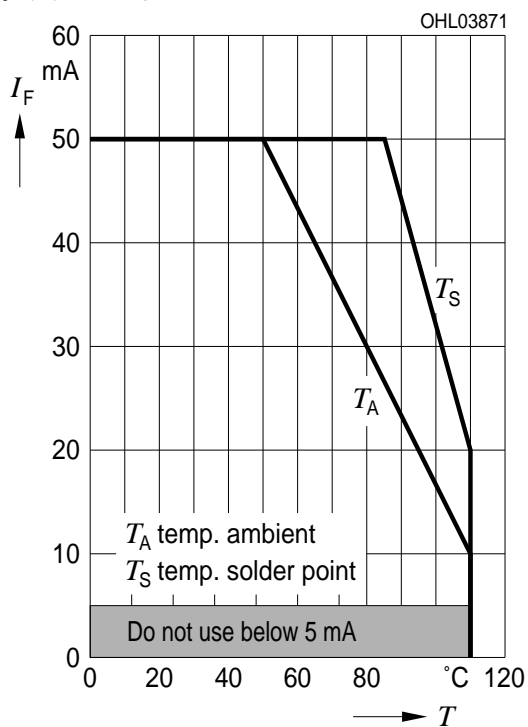

**Maximal zulässiger Durchlassstrom true grün**  
**Max. Permissible Forward Current true green**  
 $I_F = f(T)$ ; 3 chips on

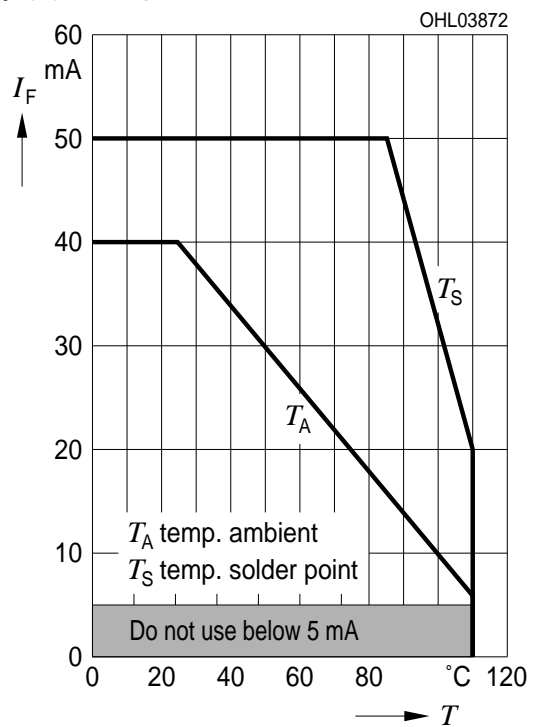

**Maximal zulässiger Durchlassstrom blau**  
**Max. Permissible Forward Current blue**  
 $I_F = f(T)$ ; 1 chip on

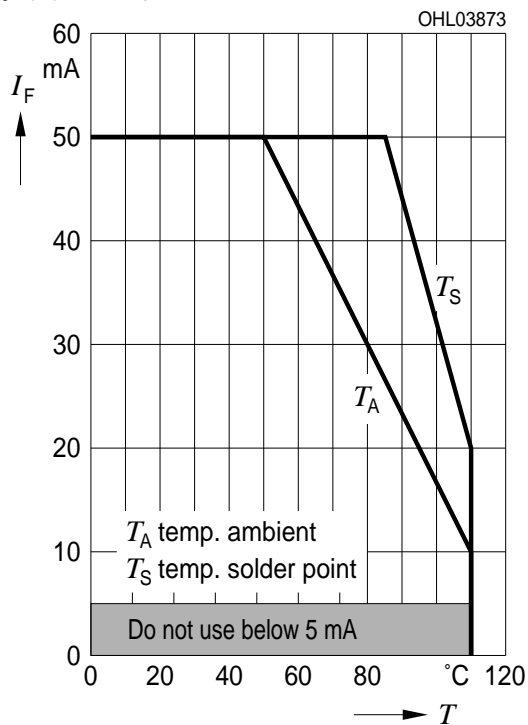

**Maximal zulässiger Durchlassstrom blau**  
**Max. Permissible Forward Current blue**  
 $I_F = f(T)$ ; 3 chips on

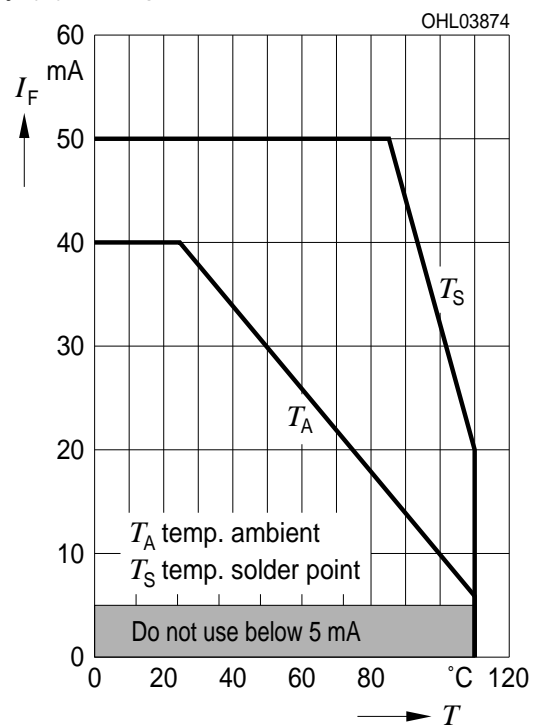

**Exemplarische durchschnittliche Lebensdauer für mittlere Helligkeitsgruppe**<sup>2) Seite 17</sup>  
**Exemplary median Lifetime for median Brightness Group**<sup>2) page 17</sup>

Bedingungen Conditions	mittlere Lebensdauer median Lifetime	Einheit Unit
$I_F = 20$ mA (blue, true green) $I_F = 15$ mA (red) $T_S = 25^\circ\text{C}$	>100.000*	Betriebsstunden operating hours
$I_F = 15$ mA (blue, true green) $I_F = 20$ mA (red) $T_S = 85^\circ\text{C}$	70.000*	Betriebsstunden operating hours

\* lifetime L50 / B50

**Zulässige Impulsbelastbarkeit**  
**Permissible Pulse Handling Capability**  
 Duty cycle  $D =$  parameter,  $T_A = 25\text{ °C}$   
 $I_F = f(t_p)$ ; red (1 Chip on)

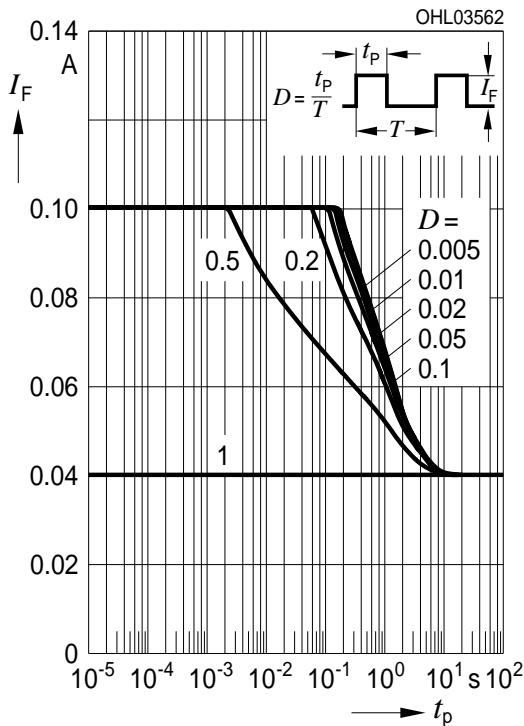

**Zulässige Impulsbelastbarkeit**  
**Permissible Pulse Handling Capability**  
 Duty cycle  $D =$  parameter,  $T_A = 25\text{ °C}$   
 $I_F = f(t_p)$ ; red (3 Chips on)

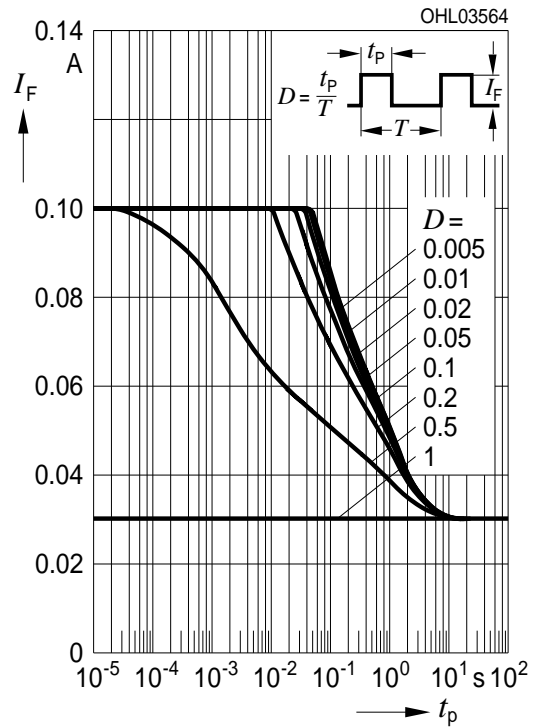

**Zulässige Impulsbelastbarkeit**  
**Permissible Pulse Handling Capability**  
 Duty cycle  $D =$  parameter,  $T_A = 85\text{ °C}$   
 $I_F = f(t_p)$ ; red (1 Chip on)

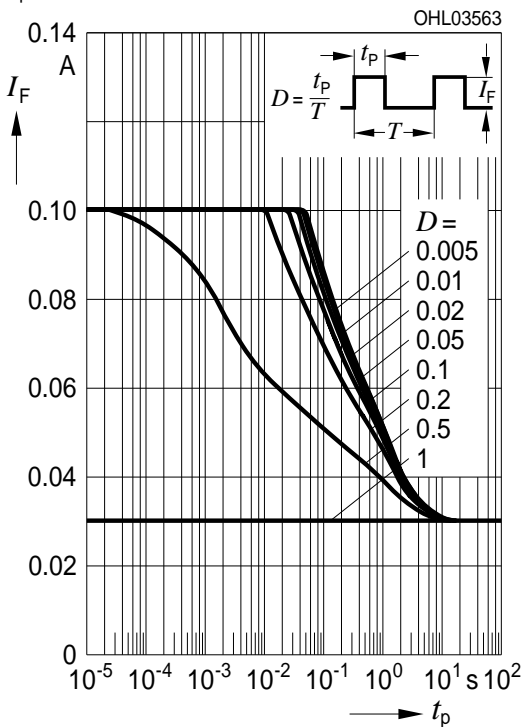

**Zulässige Impulsbelastbarkeit**  
**Permissible Pulse Handling Capability**  
 Duty cycle  $D =$  parameter,  $T_A = 85\text{ °C}$   
 $I_F = f(t_p)$ ; red (3 Chips on)

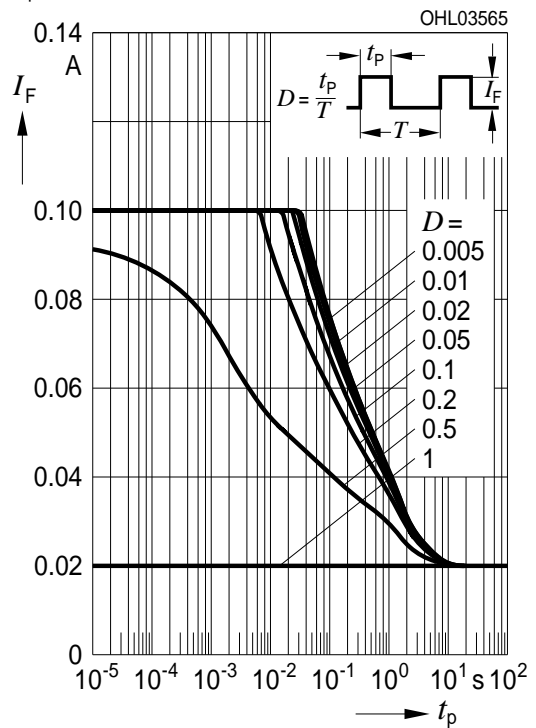

**Zulässige Impulsbelastbarkeit**  
**Permissible Pulse Handling Capability**  
 Duty cycle  $D =$  parameter,  $T_A = 25\text{ °C}$   
 $I_F = f(t_p)$ ; true green (1 Chip on)

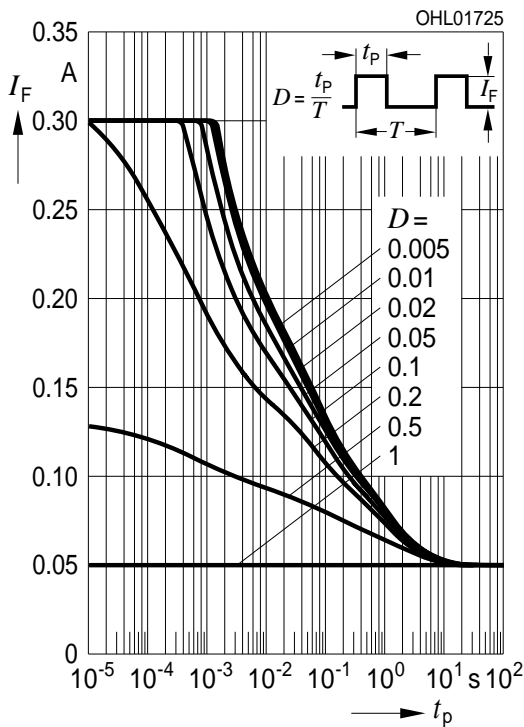

**Zulässige Impulsbelastbarkeit**  
**Permissible Pulse Handling Capability**  
 Duty cycle  $D =$  parameter,  $T_A = 25\text{ °C}$   
 $I_F = f(t_p)$ ; true green (3 Chips on)

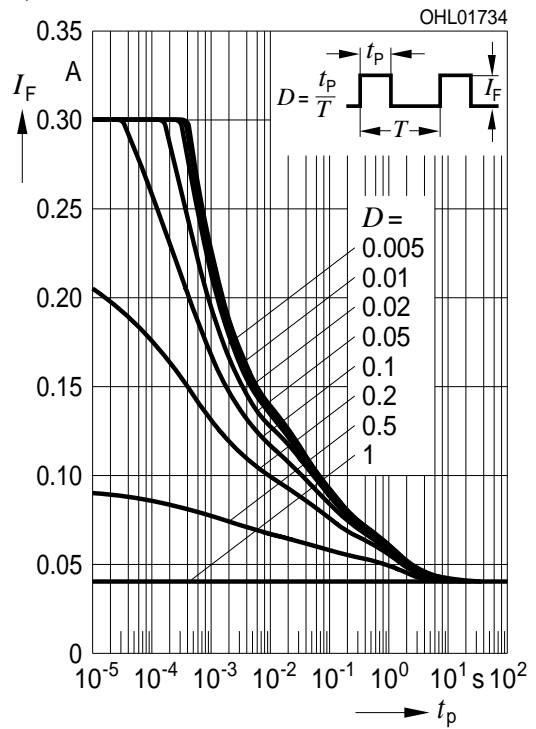

**Zulässige Impulsbelastbarkeit**  
**Permissible Pulse Handling Capability**  
 Duty cycle  $D =$  parameter,  $T_A = 85\text{ °C}$   
 $I_F = f(t_p)$ ; true green (1 Chip on)

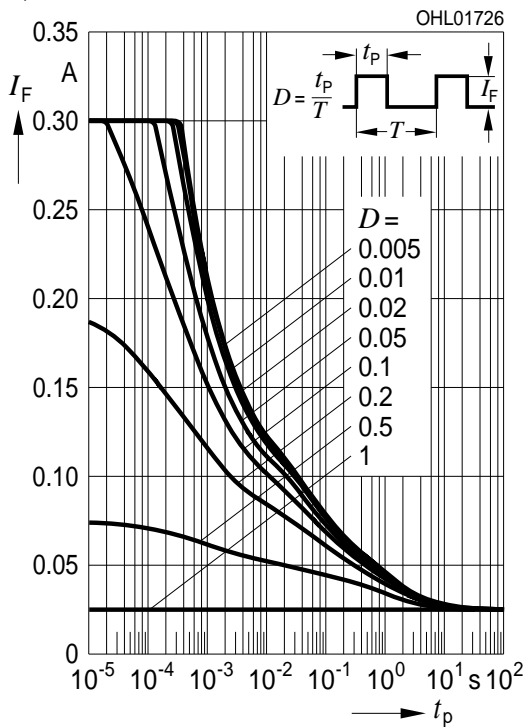

**Zulässige Impulsbelastbarkeit**  
**Permissible Pulse Handling Capability**  
 Duty cycle  $D =$  parameter,  $T_A = 85\text{ °C}$   
 $I_F = f(t_p)$ ; true green (3 Chips on)

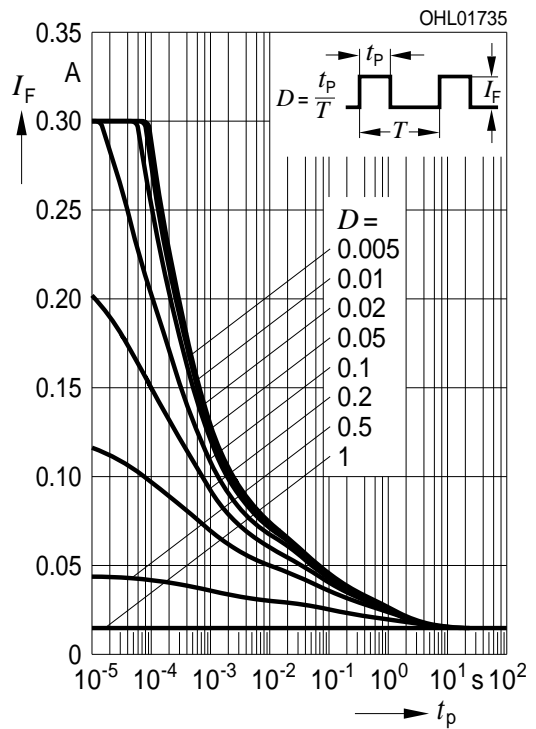



**Zulässige Impulsbelastbarkeit**  
**Permissible Pulse Handling Capability**  
 Duty cycle  $D =$  parameter,  $T_A = 25\text{ °C}$   
 $I_F = f(t_p)$ ; blue (1 Chip on)

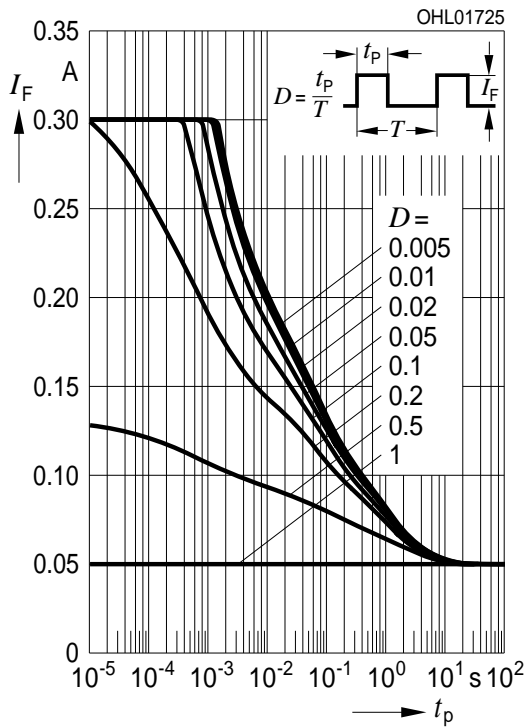

**Zulässige Impulsbelastbarkeit**  
**Permissible Pulse Handling Capability**  
 Duty cycle  $D =$  parameter,  $T_A = 25\text{ °C}$   
 $I_F = f(t_p)$ ; blue (3 Chips on)

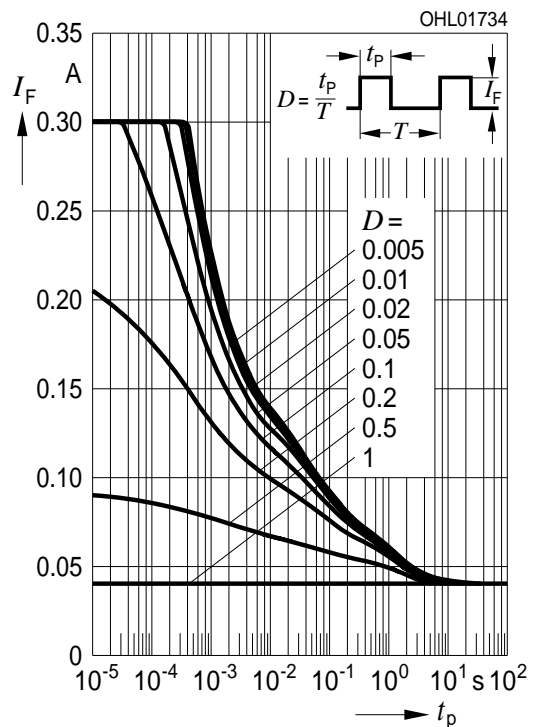

**Zulässige Impulsbelastbarkeit**  
**Permissible Pulse Handling Capability**  
 Duty cycle  $D =$  parameter,  $T_A = 85\text{ °C}$   
 $I_F = f(t_p)$ ; blue (1 Chip on)

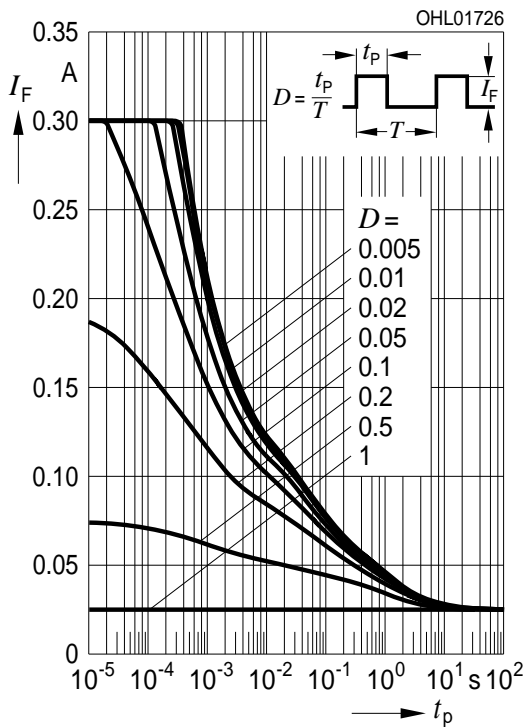

**Zulässige Impulsbelastbarkeit**  
**Permissible Pulse Handling Capability**  
 Duty cycle  $D =$  parameter,  $T_A = 85\text{ °C}$   
 $I_F = f(t_p)$ ; blue (3 Chips on)

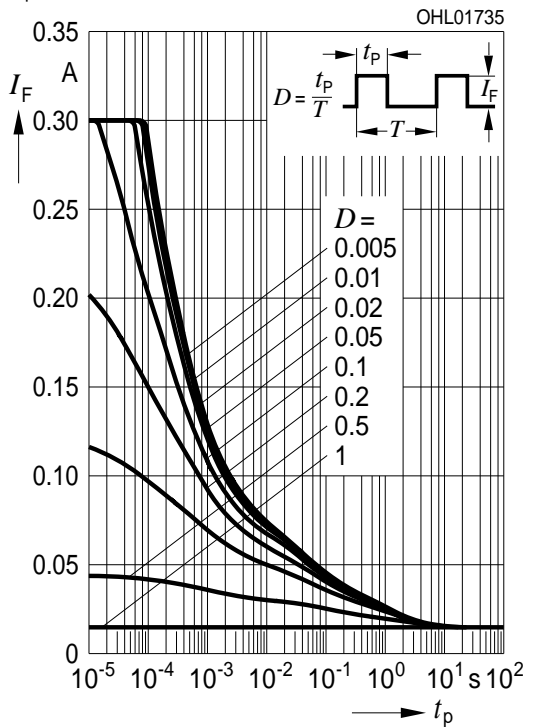

Maßzeichnung<sup>8)</sup> Seite 25  
 Package Outlines<sup>8)</sup> page 25

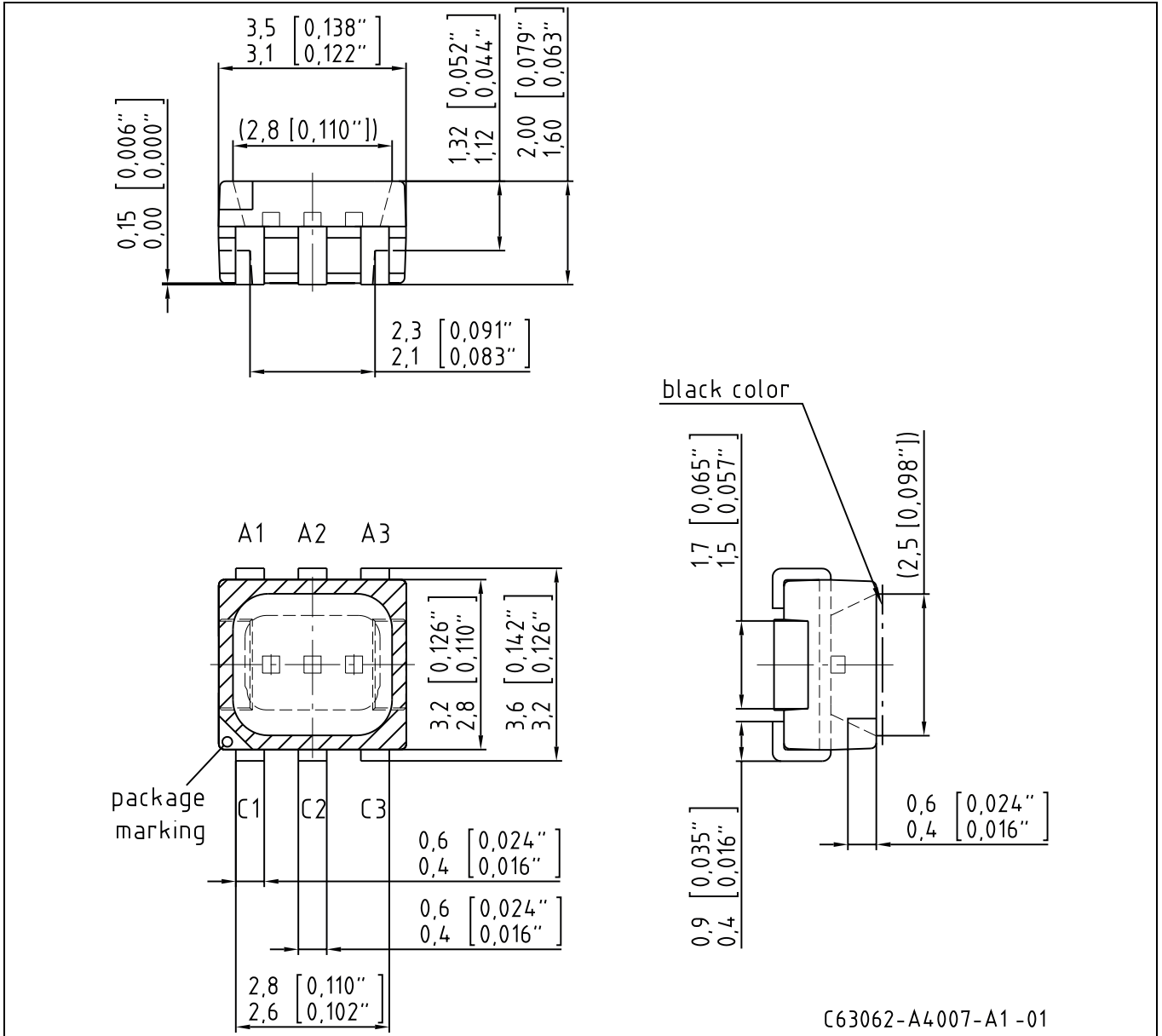

C1	Cathode	Blue (B)
A1	Anode	Blue (B)
C2	Cathode	True Green (T)
A2	Anode	True Green (T)
C3	Cathode	Red (R)
A3	Anode	Red (R)

Gewicht / Approx. weight:

40 mg

Gurtung / Polarität und Lage<sup>8)</sup> Seite 25

Verpackungseinheit 1000/Rolle, ø180 mm  
oder 4000/Rolle, ø330 mm

Method of Taping / Polarity and Orientation<sup>8)</sup> page 25

Packing unit 1000/reel, ø180 mm  
or 4000/reel, ø330 mm

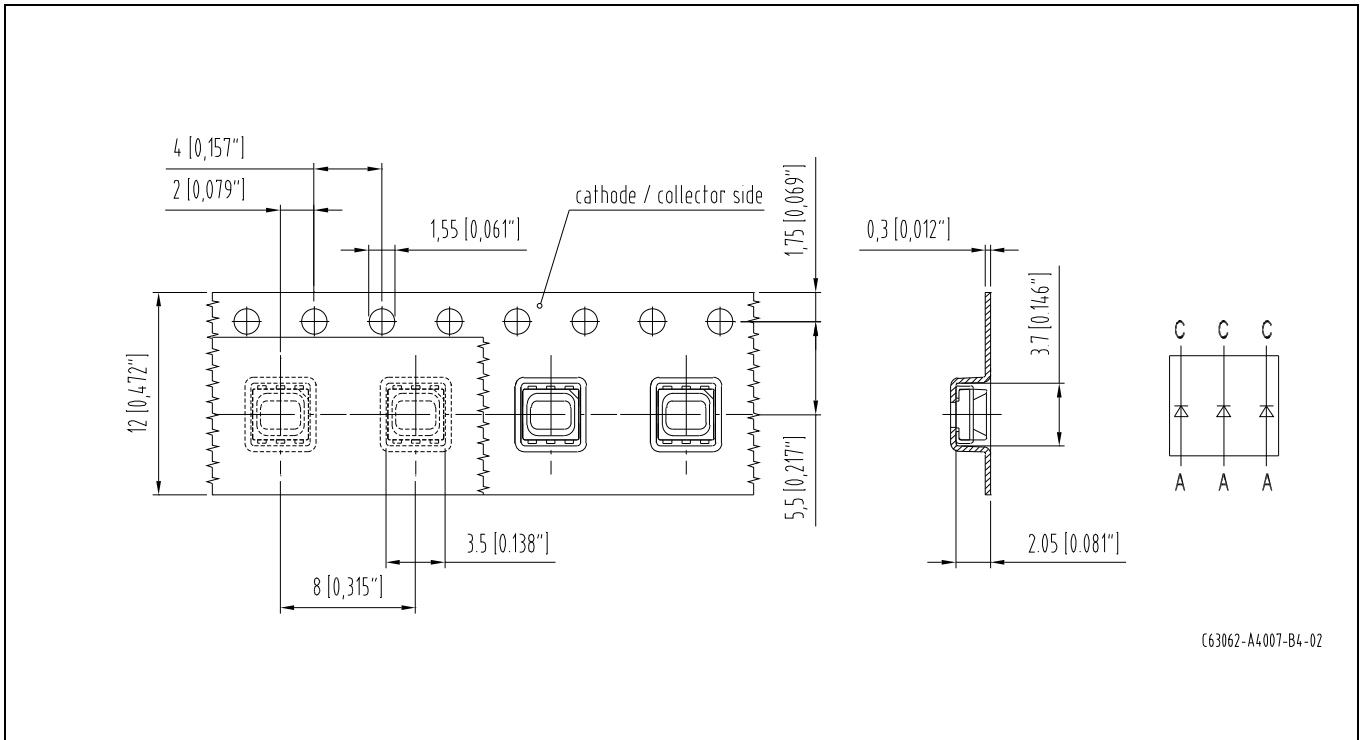

Empfohlenes Lötpadding<sup>8) 9)</sup> Seite 25  
 Recommended Solder Pad<sup>8) 9)</sup> page 25

Reflow Löten  
 Reflow Soldering

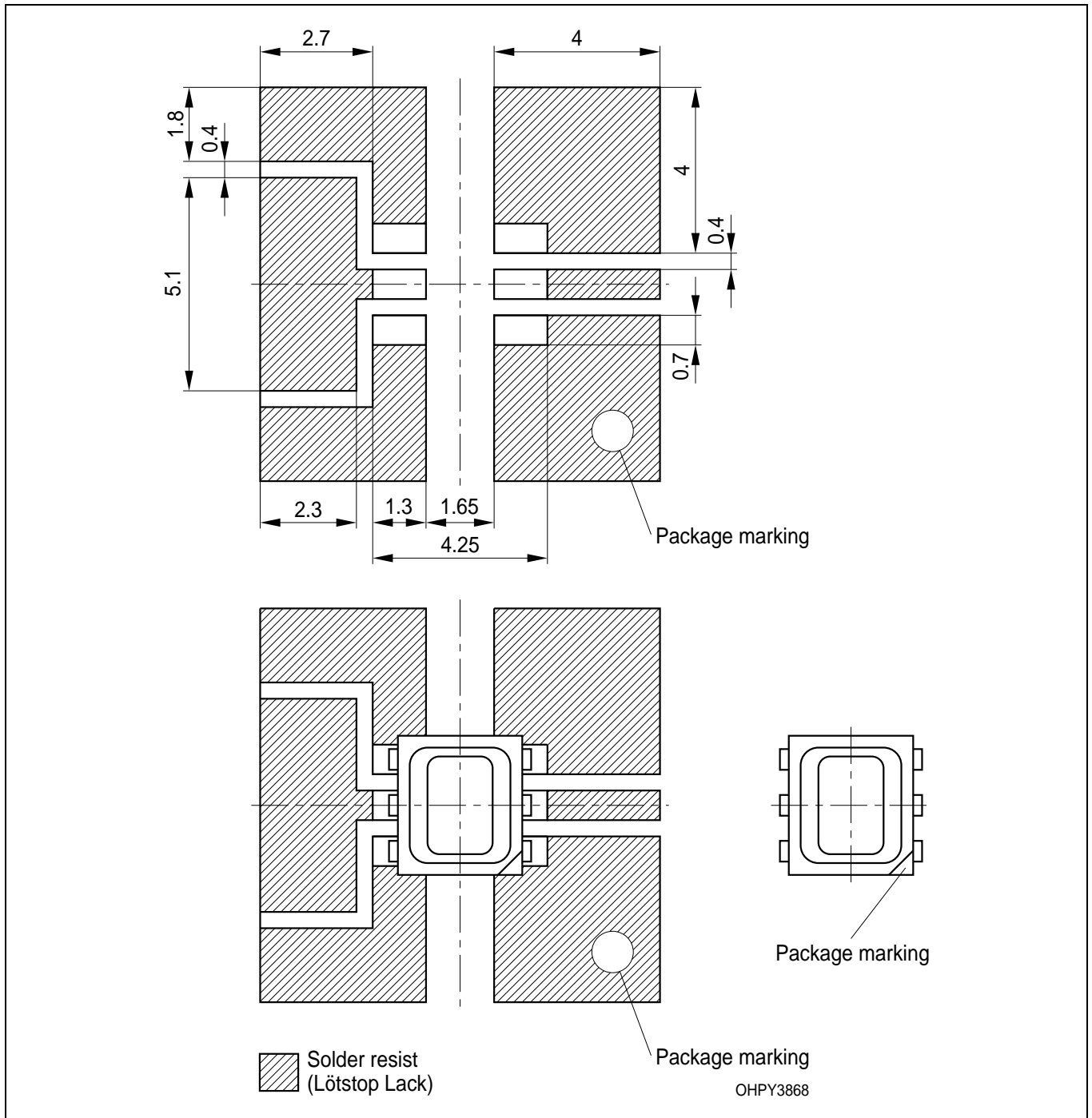

**Lötbedingungen**  
**Soldering Conditions**  
**Reflow Lötprofil für bleifreies Löten**  
**Reflow Soldering Profile for lead free soldering**

Vorbehandlung nach JEDEC Level 4  
 Preconditioning acc. to JEDEC Level 4  
 (nach J-STD-020D.01)  
 (acc. to J-STD-020D.01)

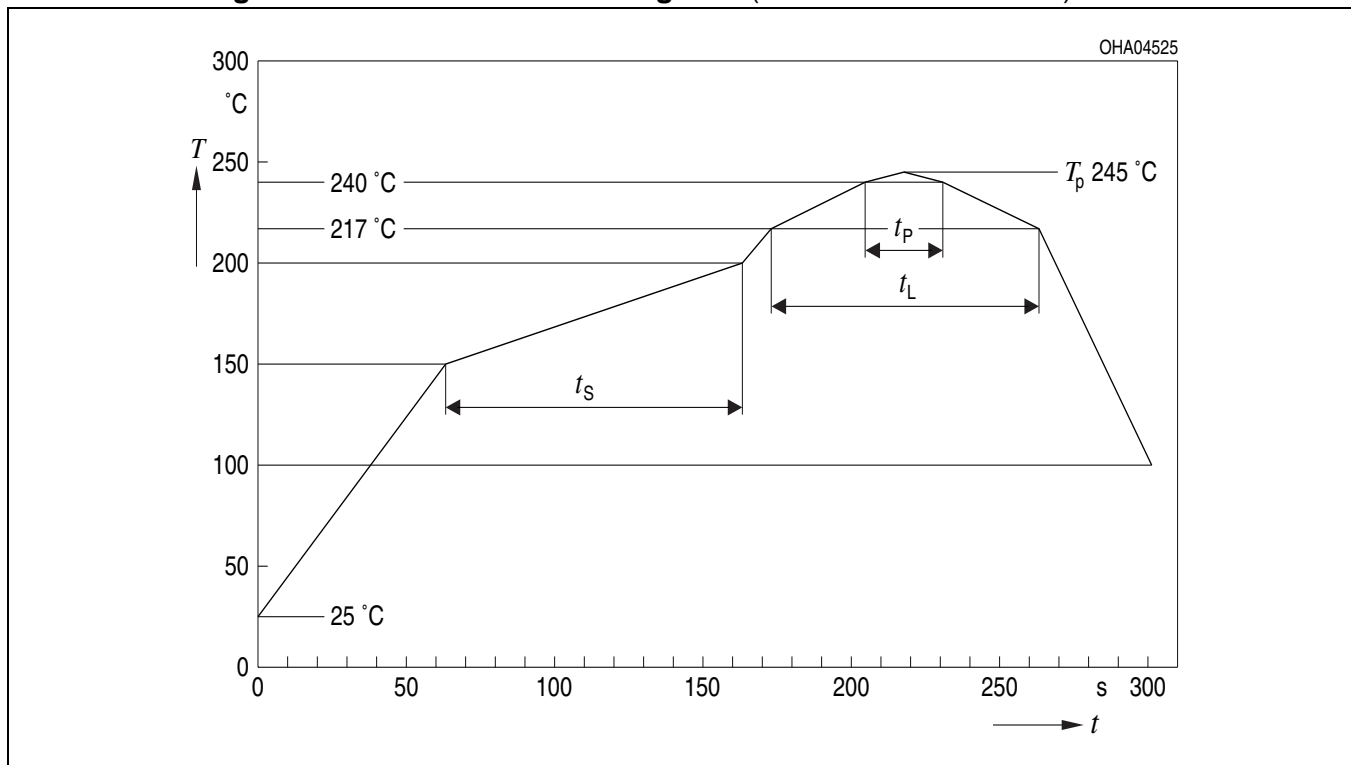

Profile Feature	Pb-Free (SnAgCu) Assembly	
	Recommendation	Max. Ratings
Ramp-up Rate to Preheat*) 25°C to 150°C	2°C / sec	3°C / sec
Time $t_s$ from $T_{Smin}$ to $T_{Smax}$ (150°C to 200°C)	100s	min. 60sec max. 120sec
Ramp-up Rate to Peak*) 180°C to $T_p$	2°C / sec	3°C / sec
Liquidus Temperature $T_L$	217°C	
Time $t_L$ above $T_L$	80sec	max. 100sec
Peak Temperature $T_p$	245°C	max. 260°C
Time $t_p$ within 5°C of the specified peak temperature $T_p - 5K$	20sec	min. 10sec max. 30sec
Ramp-down Rate* $T_p$ to 100°C	3°K / sec	6°K / sec maximum
Time 25°C to Peak temperature		max. 8 min.

All temperatures refer to the center of the package, measured on the top of the component  
 \* slope calculation  $\Delta T/\Delta t$ :  $\Delta t$  max. 5 sec; fulfillment for the whole T-range

**Barcode-Produkt-Etikett (BPL)**  
**Barcode-Product-Label (BPL)**

**OSRAM Opto Semiconductors**

(6P) BATCH NO: 1234567890



(1T) LOT NO: 1234567890 (9D) D/C: 1234



(X) PROD NO: 123456789 (Q) QTY: 9999 (G) GROUP: XX-XX-X-X



LX XXXX BIN1: XX-XX-X-XXX-X

RoHS Compliant



ML Temp ST  
2 260 °C R



Pack: R18  
DEMY 022  
B\_R999\_1880.1642 R

OHA04563

**Gurtverpackung**  
**Tape and Reel**

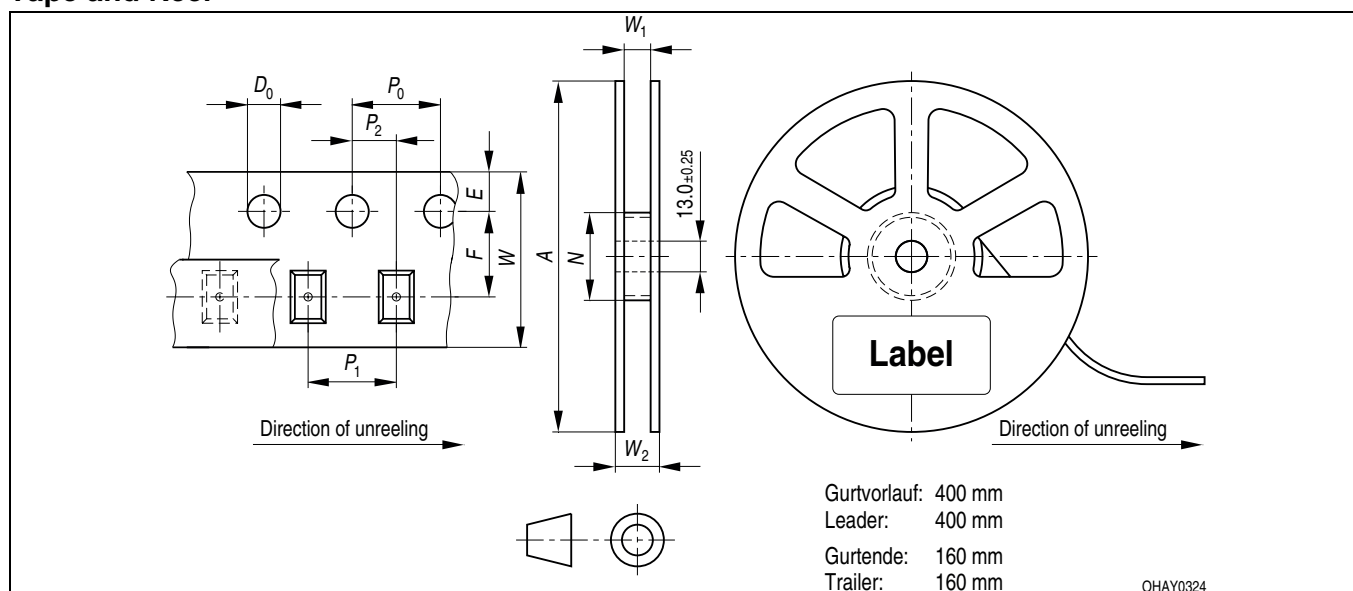

Tape dimensions in mm (inch)

<i>W</i>	<i>P<sub>0</sub></i>	<i>P<sub>1</sub></i>	<i>P<sub>2</sub></i>	<i>D<sub>0</sub></i>	<i>E</i>	<i>F</i>
$12^{+0.3}_{-0.1}$	$4 \pm 0.1$ (0.157 ± 0.004)	$8 \pm 0.1$ (0.315 ± 0.004)	$2 \pm 0.05$ (0.079 ± 0.002)	$1.5 \pm 0.1$ (0.059 ± 0.004)	$1.75 \pm 0.1$ (0.069 ± 0.004)	$5.5 \pm 0.05$ (0.217 ± 0.002)

Reel dimensions in mm (inch)

<i>A</i>	<i>W</i>	<i>N<sub>min</sub></i>	<i>W<sub>1</sub></i>	<i>W<sub>2 max</sub></i>
180 (7)	12 (0.472)	60 (2.362)	$12.4 + 2$ (0.488 + 0.079)	18.4 (0.724)
330 (13)	12 (0.472)	60 (2.362)	$12.4 + 2$ (0.488 + 0.079)	18.4 (0.724)

**Trockenverpackung und Materialien**  
**Dry Packing Process and Materials**

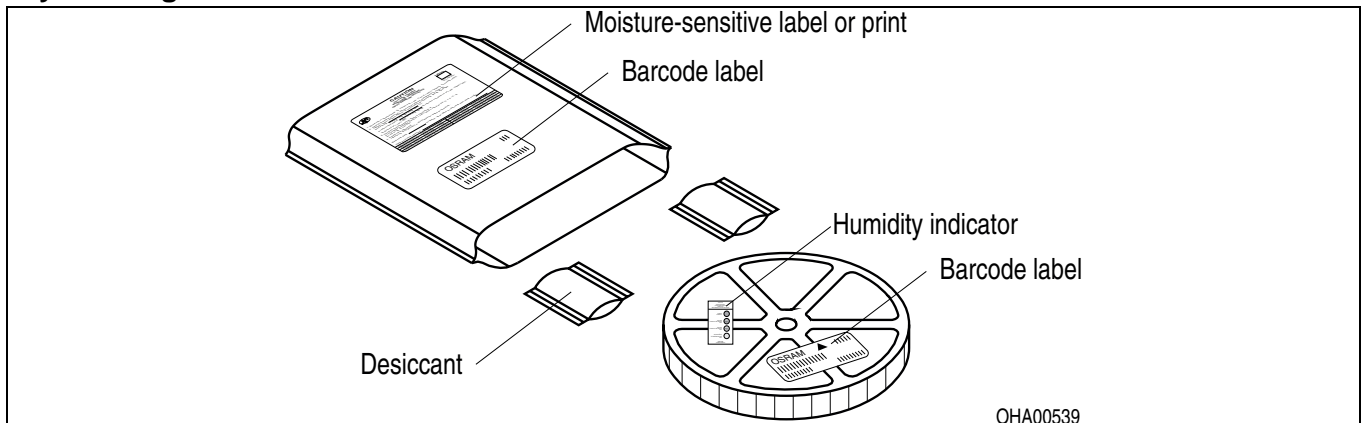

*Anm.: Feuchteempfindliche Produkte sind verpackt in einem Trockenbeutel zusammen mit einem Trockenmittel und einer Feuchteindikatorkarte  
 Bezüglich Trockenverpackung finden Sie weitere Hinweise im Internet und in unserem Short Form Catalog im Kapitel "Gurtung und Verpackung" unter dem Punkt "Trockenverpackung". Hier sind Normenbezüge, unter anderem ein Auszug der JEDEC-Norm, enthalten.*

*Note: Moisture-sensitive product is packed in a dry bag containing desiccant and a humidity card.  
 Regarding dry pack you will find further information in the internet and in the Short Form Catalog in chapter "Tape and Reel" under the topic "Dry Pack". Here you will also find the normative references like JEDEC.*

**Kartonverpackung und Materialien**  
**Transportation Packing and Materials**

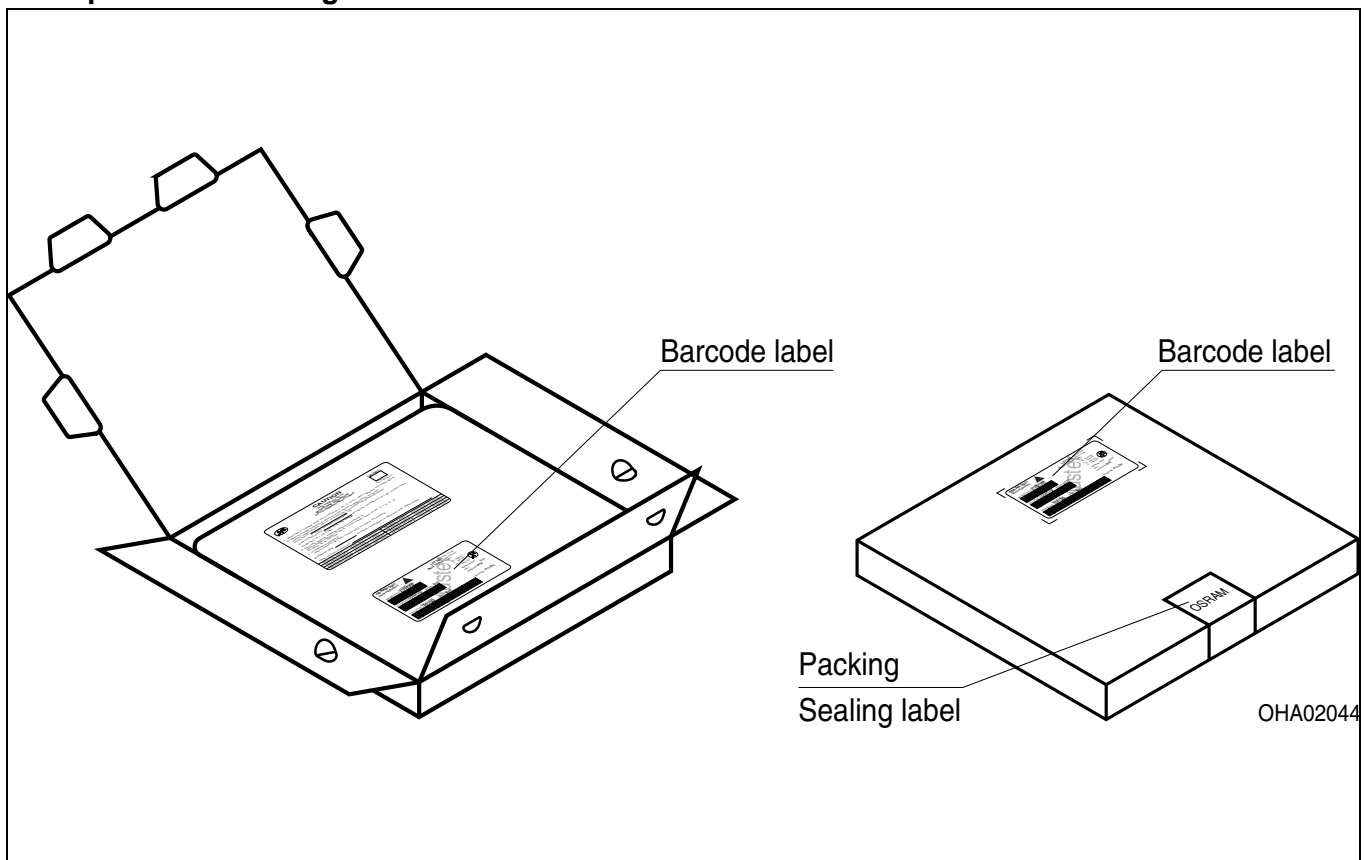

**Revision History: 2012-03-16**

Previous Version: 2010-11-17

Page	Subjects (major changes since last revision)	Date of change
18	Package outlines updated	2009-05-29
2	Ordering code for reel ø180 mm added	2009-05-29
22	OS-IN-2010-032	2010-10-04
all	Final datasheet created	2010-11-17
21	OS-IN-2012-005	2012-03-16

**Attention please!**

The information describes the type of component and shall not be considered as assured characteristics. Terms of delivery and rights to change design reserved. Due to technical requirements components may contain dangerous substances. For information on the types in question please contact our Sales Organization. If printed or downloaded, please find the latest version in the Internet.

**Packing**

Please use the recycling operators known to you. We can also help you – get in touch with your nearest sales office. By agreement we will take packing material back, if it is sorted. You must bear the costs of transport. For packing material that is returned to us unsorted or which we are not obliged to accept, we shall have to invoice you for any costs incurred.

**Components used in life-support devices or systems must be expressly authorized for such purpose!** Critical components<sup>10) page 25</sup> may only be used in life-support devices or systems<sup>11) page 25</sup> with the express written approval of OSRAM OS.



**Fußnoten:**

- 1) Helligkeitswerte werden mit einer Stromeinprägedauer von 25 ms und einer Genauigkeit von  $\pm 11\%$  ermittelt.
- 2) Die LED kann kurzzeitig in Sperrichtung betrieben werden.
- 3)  $R_{thJA}$  ergibt sich bei Montage auf PC-Board FR 4 (Padgröße  $\geq 16 \text{ mm}^2$  je Pad)
- 4) Wellenlängen werden mit einer Stromeinprägedauer von 25 ms und einer Genauigkeit von  $\pm 1 \text{ nm}$  ermittelt.
- 5) Spannungswerte werden mit einer Stromeinprägedauer von 1 ms und einer Genauigkeit von  $\pm 0,1 \text{ V}$  ermittelt.
- 6) Wegen der besonderen Prozessbedingungen bei der Herstellung von LED können typische oder abgeleitete technische Parameter nur aufgrund statistischer Werte wiedergegeben werden. Diese stimmen nicht notwendigerweise mit den Werten jedes einzelnen Produktes überein, dessen Werte sich von typischen und abgeleiteten Werten oder typischen Kennlinien unterscheiden können. Falls erforderlich, z.B. aufgrund technischer Verbesserungen, werden diese typischen Werte ohne weitere Ankündigung geändert.
- 7) Im gestrichelten Bereich der Kennlinien muss mit erhöhten Helligkeitsunterschieden zwischen Leuchtdioden innerhalb einer Verpackungseinheit gerechnet werden.  
Dimmverhältnis im Gleichstrom-Betrieb max. 5:1 für red
- 8) Maße werden wie folgt angegeben: mm (inch)
- 9) Gehäuse hält TTW-Löthitze aus nach CECC 00802
- 10) Ein kritisches Bauteil ist ein Bauteil, das in lebenserhaltenden Apparaten oder Systemen eingesetzt wird und dessen Defekt voraussichtlich zu einer Fehlfunktion dieses lebenserhaltenden Apparates oder Systems führen wird oder die Sicherheit oder Effektivität dieses Apparates oder Systems beeinträchtigt.
- 11) Lebenserhaltende Apparate oder Systeme sind für  
(a) die Implantierung in den menschlichen Körper oder  
(b) für die Lebenserhaltung bestimmt.  
Falls sie versagen, kann davon ausgegangen werden, dass die Gesundheit und das Leben des Patienten in Gefahr ist.

**Remarks:**

- 1) Brightness groups are tested at a current pulse duration of 25 ms and a tolerance of  $\pm 11\%$ .
- 2) Driving the LED in reverse direction is suitable for short term application.
- 3)  $R_{thJA}$  results from mounting on PC board FR 4 (pad size  $\geq 16 \text{ mm}^2$  per pad)
- 4) Wavelengths are tested at a current pulse duration of 25 ms and a tolerance of  $\pm 1 \text{ nm}$ .
- 5) Forward voltages are tested at a current pulse duration of 1 ms and a tolerance of  $\pm 0.1 \text{ V}$ .
- 6) Due to the special conditions of the manufacturing processes of LED, the typical data or calculated correlations of technical parameters can only reflect statistical figures. These do not necessarily correspond to the actual parameters of each single product, which could differ from the typical data and calculated correlations or the typical characteristic line. If requested, e.g. because of technical improvements, these typ. data will be changed without any further notice.
- 7) In the range where the line of the graph is broken, you must expect higher brightness differences between single LEDs within one packing unit.  
Dimming range for direct current mode max. 5:1 for red
- 8) Dimensions are specified as follows: mm (inch)
- 9) Package able to withstand TTW-soldering heat acc. to CECC 00802
- 10) A critical component is a component used in a life-support device or system whose failure can reasonably be expected to cause the failure of that life-support device or system, or to affect its safety or the effectiveness of that device or system.
- 11) Life support devices or systems are intended  
(a) to be implanted in the human body,  
or  
(b) to support and/or maintain and sustain human life.  
If they fail, it is reasonable to assume that the health and the life of the user may be endangered.

Published by  
**OSRAM Opto Semiconductors GmbH**  
 Wernerwerkstrasse 2, D-93049 Regensburg  
[www.osram-os.com](http://www.osram-os.com)  
 © All Rights Reserved.

EU RoHS and China RoHS compliant product



此产品符合欧盟 RoHS 指令的要求；  
 按照中国的相关法规和标准，不含有毒有害物质或元素。

# Mouser Electronics

Authorized Distributor

Click to View Pricing, Inventory, Delivery & Lifecycle Information:

[Osram Opto Semiconductor:](#)

[LRTBGFTG-T7AW-1+V7A7-29+R](#)