

# NTK3139P

## Power MOSFET

-20 V, -780 mA, Single P-Channel with ESD Protection, SOT-723



ON Semiconductor®

<http://onsemi.com>

### Features

- P-channel Switch with Low  $R_{DS(on)}$
- 44% Smaller Footprint and 38% Thinner than SC-89
- Low Threshold Levels Allowing 1.5 V  $R_{DS(on)}$  Rating
- Operated at Low Logic Level Gate Drive
- These Devices are Pb-Free, Halogen Free/BFR Free and are RoHS Compliant

### Applications

- Load/Power Switching
- Interfacing, Logic Switching
- Battery Management for Ultra Small Portable Electronics

### MAXIMUM RATINGS ( $T_J = 25^\circ\text{C}$ unless otherwise stated)

| Parameter   |                        | Symbol                   | Value                    | Unit             |    |
|---|------------------------|--------------------------|--------------------------|------------------|----|
| Drain-to-Source Voltage   |                        | $V_{DSS}$                | -20                      | V                |    |
| Gate-to-Source Voltage  |                        | $V_{GS}$                 | $\pm 6$                  | V                |    |
| Continuous Drain Current (Note 1)                                 | Steady State           | $I_D$                    | $T_A = 25^\circ\text{C}$ | -780             | mA |
|   |                        |                          | $T_A = 85^\circ\text{C}$ | -570             |    |
|   | $t \leq 5 \text{ s}$   | $T_A = 25^\circ\text{C}$ | -870                     |                  |    |
| Power Dissipation (Note 1)  | Steady State           | $P_D$                    | $T_A = 25^\circ\text{C}$ | 450              | mW |
|   | $t \leq 5 \text{ s}$   |                          | 550                      |                  |    |
| Continuous Drain Current (Note 2)                                 | Steady State           | $I_D$                    | $T_A = 25^\circ\text{C}$ | -660             | mA |
|   |                        |                          | $T_A = 85^\circ\text{C}$ | -480             |    |
|   |                        |                          | $T_A = 25^\circ\text{C}$ | $P_D$            |    |
| Pulsed Drain Current  | $t_p = 10 \mu\text{s}$ | $I_{DM}$                 | -1.2                     | A                |    |
| Operating Junction and Storage Temperature                        |                        | $T_J, T_{STG}$           | -55 to 150               | $^\circ\text{C}$ |    |
| Lead Temperature for Soldering Purposes (1/8" from case for 10 s) |                        | $T_L$                    | 260                      | $^\circ\text{C}$ |    |

Stresses exceeding Maximum Ratings may damage the device. Maximum Ratings are stress ratings only. Functional operation above the Recommended Operating Conditions is not implied. Extended exposure to stresses above the Recommended Operating Conditions may affect device reliability.

1. Surface mounted on FR4 board using 1 in sq pad size (Cu area = 1.127 in sq [1 oz] including traces)
2. Surface mounted on FR4 board using the minimum recommended pad size

| $V_{(BR)DSS}$ | $R_{DS(on)}$ TYP       | $I_D$ Max |
|---------------|------------------------|-----------|
| -20 V         | 0.38 $\Omega$ @ -4.5 V | -780 mA   |
|               | 0.52 $\Omega$ @ -2.5 V | -660 mA   |
|               | 0.70 $\Omega$ @ -1.8 V | -100 mA   |
|               | 0.95 $\Omega$ @ -1.5 V | -100 mA   |

### SOT-723 (3-LEAD)

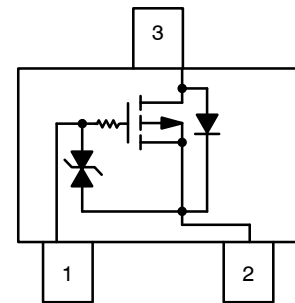

Top View

- 1 - Gate
- 2 - Source
- 3 - Drain

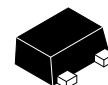

SOT-723  
CASE 631AA  
STYLE 5

### MARKING DIAGRAM



- KD = Specific Device Code
- M = Date Code

### ORDERING INFORMATION

| Device      | Package            | Shipping†          |
|-------------|--------------------|--------------------|
| NTK3139PT1G | SOT-723<br>Pb-Free | 4000 / Tape & Reel |
| NTK3139PT1H |                    |                    |
| NTK3139PT5G |                    |                    |
| NTK3139PT5H |                    | 8000 / Tape & Reel |

†For information on tape and reel specifications, including part orientation and tape sizes, please refer to our Tape and Reel Packaging Specification Brochure, BRD8011/D.

# NTK3139P

## THERMAL RESISTANCE RATINGS

| Parameter   | Symbol          | Max | Unit |
|---|-----------------|-----|------|
| Junction-to-Ambient – Steady State (Note 3)             | $R_{\theta JA}$ | 280 | °C/W |
| Junction-to-Ambient – $t = 5$ s (Note 3)                | $R_{\theta JA}$ | 228 |      |
| Junction-to-Ambient – Steady State Minimum Pad (Note 4) | $R_{\theta JA}$ | 400 |      |

3. Surface mounted on FR4 board using 1 in sq pad size (Cu area = 1.127 in sq [1 oz] including traces)  
 4. Surface mounted on FR4 board using the minimum recommended pad size

## MOSFET ELECTRICAL CHARACTERISTICS ( $T_J = 25^\circ\text{C}$ unless otherwise specified)

| Parameter | Symbol | Test Condition | Min | Typ | Max | Unit |
|-----------|--------|----------------|-----|-----|-----|------|
|-----------|--------|----------------|-----|-----|-----|------|

### OFF CHARACTERISTICS

|   |                   |   |                           |       |           |         |
|---|-------------------|---|---------------------------|-------|-----------|---------|
| Drain-to-Source Breakdown Voltage                         | $V_{(BR)DSS}$     | $V_{GS} = 0$ V, $I_D = -250$ $\mu$ A                  | -20                       |       |           | V       |
| Drain-to-Source Breakdown Voltage Temperature Coefficient | $V_{(BR)DSS}/T_J$ | $I_D = -250$ $\mu$ A, Reference to $25^\circ\text{C}$ |                           | -16.5 |           | mV/°C   |
| Zero Gate Voltage Drain Current                           | $I_{DSS}$         | $V_{GS} = 0$ V,<br>$V_{DS} = -16$ V                   | $T_J = 25^\circ\text{C}$  |       | -1.0      | $\mu$ A |
|   |                   |   | $T_J = 125^\circ\text{C}$ |       | -2.0      |         |
| Gate-to-Source Leakage Current                            | $I_{GSS}$         | $V_{DS} = 0$ V, $V_{GS} = \pm 4.5$ V                  |                           |       | $\pm 2.0$ | $\mu$ A |

### ON CHARACTERISTICS (Note 5)

|  |                  |  |       |      |      |          |
|--|------------------|--|-------|------|------|----------|
| Gate Threshold Voltage                     | $V_{GS(TH)}$     | $V_{GS} = V_{DS}$ , $I_D = -250$ $\mu$ A | -0.45 |      | -1.2 | V        |
| Negative Threshold Temperature Coefficient | $V_{GS(TH)}/T_J$ |  |       | 2.4  |      | mV/°C    |
| Drain-to-Source On Resistance              | $R_{DS(on)}$     | $V_{GS} = -4.5$ V, $I_D = -780$ mA       |       | 0.38 | 0.48 | $\Omega$ |
|  |                  | $V_{GS} = -2.5$ V, $I_D = -660$ mA       |       | 0.52 | 0.67 |          |
|  |                  | $V_{GS} = -1.8$ V, $I_D = -100$ mA       |       | 0.70 | 0.95 |          |
|  |                  | $V_{GS} = -1.5$ V, $I_D = -100$ mA       |       | 0.95 | 2.20 |          |
| Forward Transconductance                   | $g_{FS}$         | $V_{DS} = -10$ V, $I_D = -540$ mA        |       | 1.2  |      | S        |

### CHARGES, CAPACITANCES AND GATE RESISTANCE

|                              |           |   |  |     |     |    |
|------------------------------|-----------|---|--|-----|-----|----|
| Input Capacitance            | $C_{ISS}$ | $V_{GS} = 0$ V, $f = 1$ MHz, $V_{DS} = -16$ V |  | 113 | 170 | pF |
| Output Capacitance           | $C_{OSS}$ |   |  | 15  | 25  |    |
| Reverse Transfer Capacitance | $C_{RSS}$ |   |  | 9.0 | 15  |    |

### SWITCHING CHARACTERISTICS, $V_{GS} = 4.5$ V (Note 6)

|                    |              |  |  |      |  |    |
|--------------------|--------------|--|--|------|--|----|
| Turn On Delay Time | $t_{d(ON)}$  | $V_{GS} = -4.5$ V, $V_{DS} = -10$ V,<br>$I_D = -200$ mA, $R_G = 10$ $\Omega$ |  | 9.0  |  | ns |
| Rise Time          | $t_r$        |  |  | 5.8  |  |    |
| TurnOff Delay Time | $t_{d(OFF)}$ |  |  | 32.7 |  |    |
| Fall Time          | $t_f$        |  |  | 20.3 |  |    |

### DRAIN SOURCE DIODE CHARACTERISTICS

|                         |          |  |                          |  |      |      |    |
|-------------------------|----------|--|--------------------------|--|------|------|----|
| Forward Diode Voltage   | $V_{SD}$ | $V_{GS} = 0$ V, $I_S = -350$ mA  | $T_J = 25^\circ\text{C}$ |  | -0.8 | -1.2 | V  |
| Reverse Recovery Time   | $t_{RR}$ | $V_{GS} = 0$ V, $dI_{SD}/dt = 100$ A/ $\mu$ s,<br>$I_S = -1.0$ A, $V_{DD} = -20$ V |                          |  | 13.2 |      | ns |
| Charge Time             | $t_a$    |  |                          |  | 11.8 |      |    |
| Discharge Time          | $t_b$    |  |                          |  | 1.4  |      |    |
| Reverse Recovery Charge | $Q_{RR}$ |  |                          |  |      | 5.0  |    |

5. Pulse Test: pulse width = 300  $\mu$ s, duty cycle = 2%  
 6. Switching characteristics are independent of operating junction temperatures

TYPICAL CHARACTERISTICS

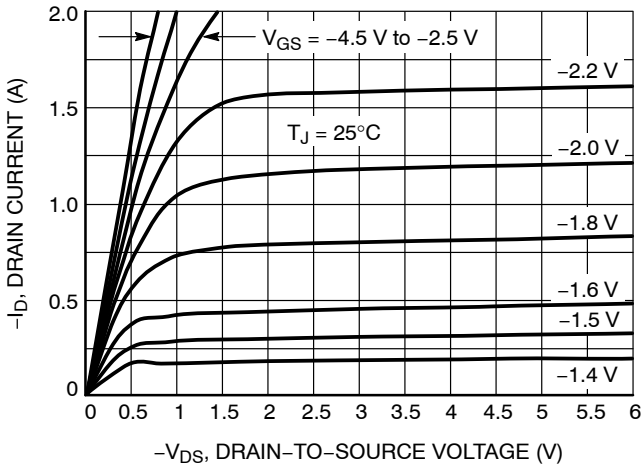

Figure 1. On-Region Characteristics

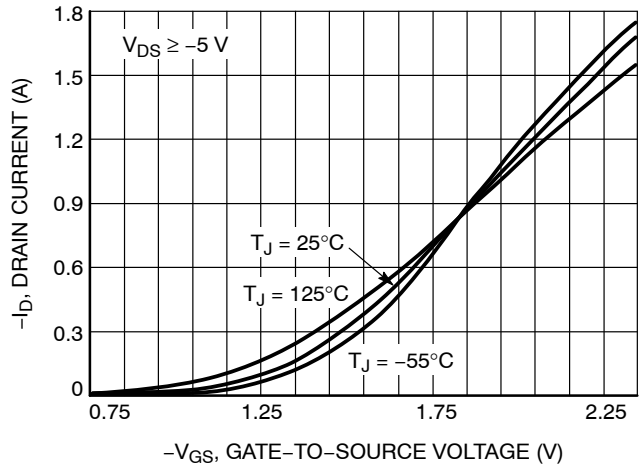

Figure 2. Transfer Characteristics

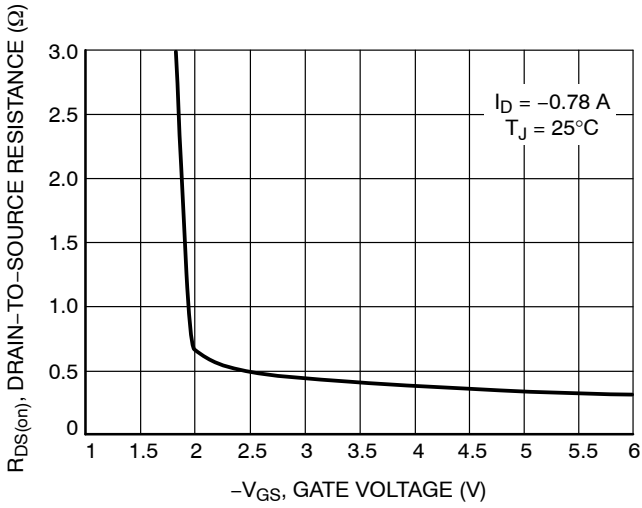

Figure 3. On-Resistance vs. Gate-to-Source Voltage

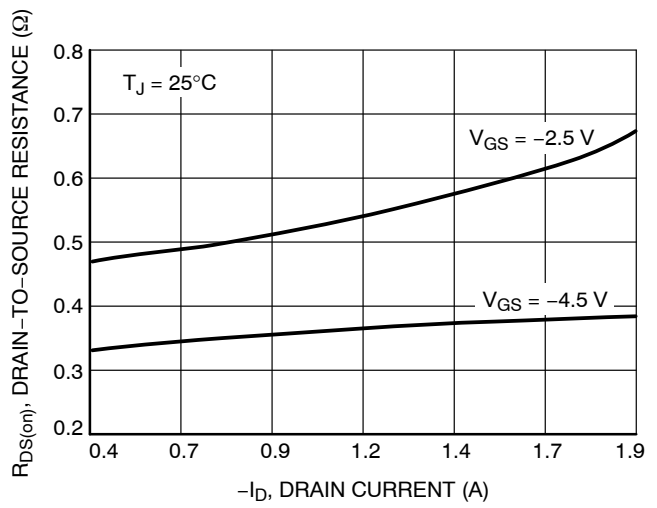

Figure 4. On-Resistance vs. Drain Current and Gate Voltage

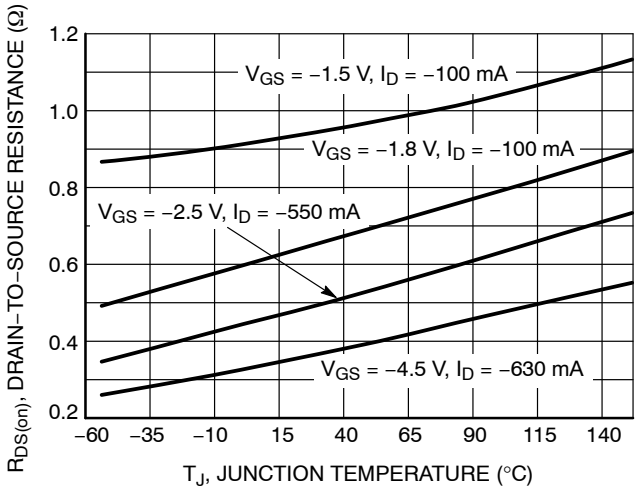

Figure 5. On-Resistance Variation with Temperature

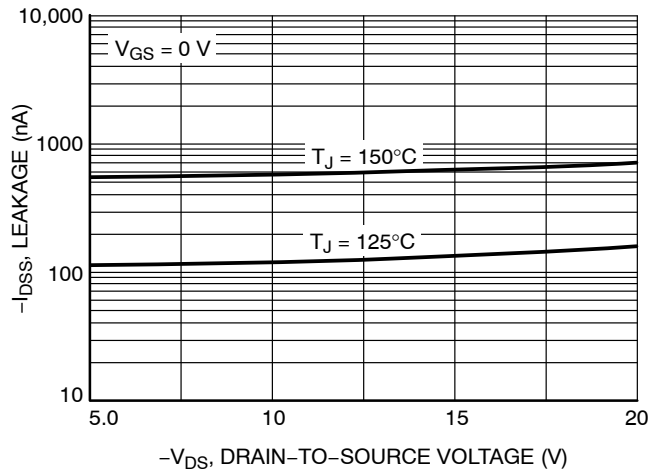

Figure 6. Drain-to-Source Leakage Current vs. Voltage

TYPICAL CHARACTERISTICS

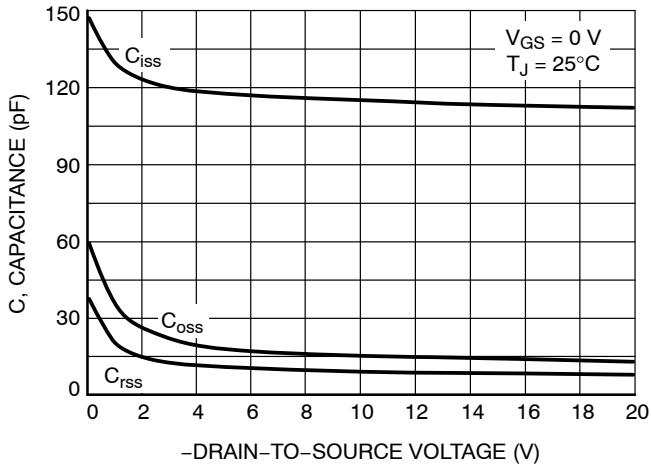

Figure 7. Capacitance Variation

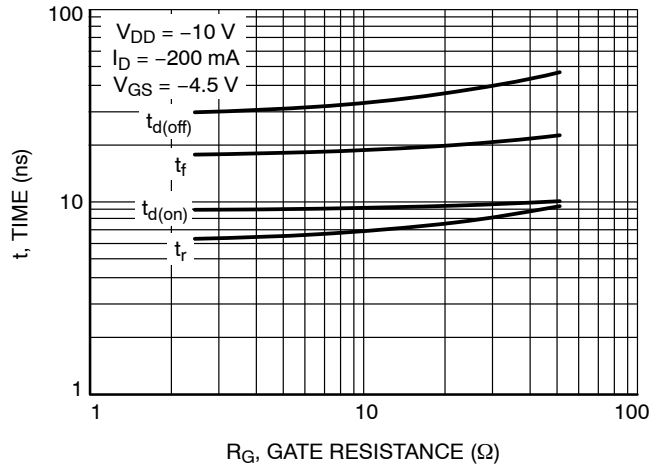

Figure 8. Resistive Switching Time Variation vs. Gate Resistance

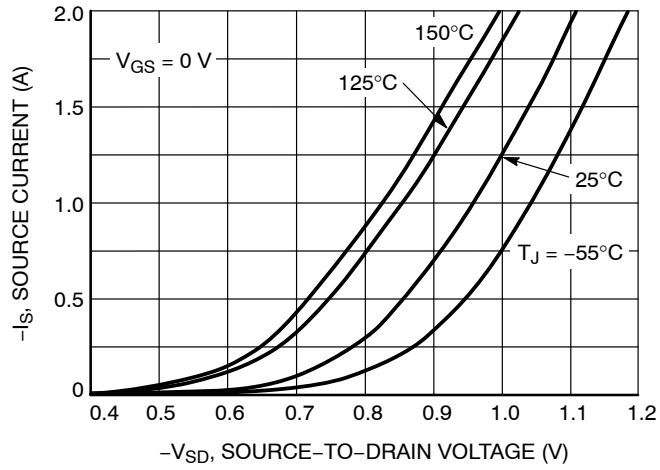
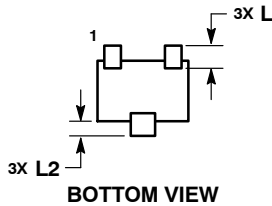
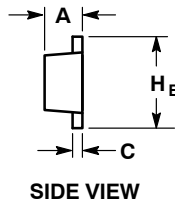
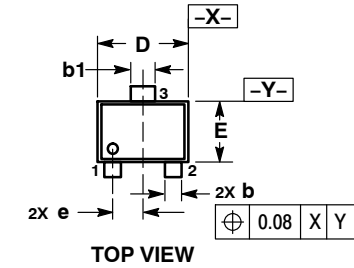

Figure 9. Diode Forward Voltage vs. Current

# NTK3139P

## PACKAGE DIMENSIONS

### SOT-723 CASE 631AA ISSUE D



#### NOTES:

1. DIMENSIONING AND TOLERANCING PER ASME Y14.5M, 1994.
2. CONTROLLING DIMENSION: MILLIMETERS.
3. MAXIMUM LEAD THICKNESS INCLUDES LEAD FINISH. MINIMUM LEAD THICKNESS IS THE MINIMUM THICKNESS OF BASE MATERIAL.
4. DIMENSIONS D AND E DO NOT INCLUDE MOLD FLASH, PROTRUSIONS OR GATE BURRS.

| DIM | MILLIMETERS |      |      |
|-----|-------------|------|------|
|     | MIN         | NOM  | MAX  |
| A   | 0.45        | 0.50 | 0.55 |
| b   | 0.15        | 0.21 | 0.27 |
| b1  | 0.25        | 0.31 | 0.37 |
| C   | 0.07        | 0.12 | 0.17 |
| D   | 1.15        | 1.20 | 1.25 |
| E   | 0.75        | 0.80 | 0.85 |
| e   | 0.40 BSC    |      |      |
| H E | 1.15        | 1.20 | 1.25 |
| L   | 0.29 REF    |      |      |
| L2  | 0.15        | 0.20 | 0.25 |

#### STYLE 5:

1. GATE
2. SOURCE
3. DRAIN

### RECOMMENDED SOLDERING FOOTPRINT\*

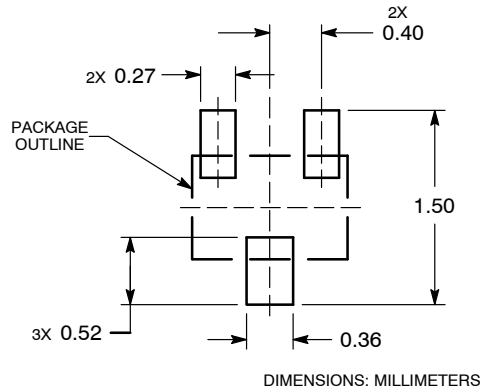

\*For additional information on our Pb-Free strategy and soldering details, please download the ON Semiconductor Soldering and Mounting Techniques Reference Manual, SOLDERRM/D.

ON Semiconductor and  are registered trademarks of Semiconductor Components Industries, LLC (SCILLC). SCILLC owns the rights to a number of patents, trademarks, copyrights, trade secrets, and other intellectual property. A listing of SCILLC's product/patent coverage may be accessed at [www.onsemi.com/site/pdf/Patent-Marking.pdf](http://www.onsemi.com/site/pdf/Patent-Marking.pdf). SCILLC reserves the right to make changes without further notice to any products herein. SCILLC makes no warranty, representation or guarantee regarding the suitability of its products for any particular purpose, nor does SCILLC assume any liability arising out of the application or use of any product or circuit, and specifically disclaims any and all liability, including without limitation special, consequential or incidental damages. "Typical" parameters which may be provided in SCILLC data sheets and/or specifications can and do vary in different applications and actual performance may vary over time. All operating parameters, including "Typicals" must be validated for each customer application by customer's technical experts. SCILLC does not convey any license under its patent rights nor the rights of others. SCILLC products are not designed, intended, or authorized for use as components in systems intended for surgical implant into the body, or other applications intended to support or sustain life, or for any other application in which the failure of the SCILLC product could create a situation where personal injury or death may occur. Should Buyer purchase or use SCILLC products for any such unintended or unauthorized application, Buyer shall indemnify and hold SCILLC and its officers, employees, subsidiaries, affiliates, and distributors harmless against all claims, costs, damages, and expenses, and reasonable attorney fees arising out of, directly or indirectly, any claim of personal injury or death associated with such unintended or unauthorized use, even if such claim alleges that SCILLC was negligent regarding the design or manufacture of the part. SCILLC is an Equal Opportunity/Affirmative Action Employer. This literature is subject to all applicable copyright laws and is not for resale in any manner.

## PUBLICATION ORDERING INFORMATION

### LITERATURE FULFILLMENT:

Literature Distribution Center for ON Semiconductor  
P.O. Box 5163, Denver, Colorado 80217 USA  
Phone: 303-675-2175 or 800-344-3860 Toll Free USA/Canada  
Fax: 303-675-2176 or 800-344-3867 Toll Free USA/Canada  
Email: [orderlit@onsemi.com](mailto:orderlit@onsemi.com)

**N. American Technical Support:** 800-282-9855 Toll Free  
USA/Canada  
**Europe, Middle East and Africa Technical Support:**  
Phone: 421 33 790 2910  
**Japan Customer Focus Center**  
Phone: 81-3-5817-1050

**ON Semiconductor Website:** [www.onsemi.com](http://www.onsemi.com)

**Order Literature:** <http://www.onsemi.com/orderlit>

For additional information, please contact your local Sales Representative

# Mouser Electronics

Authorized Distributor

Click to View Pricing, Inventory, Delivery & Lifecycle Information:

[ON Semiconductor:](#)

[NTK3139PT5G](#)