

# NDTL03N150C

## Power MOSFET 1500V, 10.5Ω, 2.5A, N-Channel



ON Semiconductor®

www.onsemi.com

### Features

- Low On-Resistance
- Ultra High Voltage
- High Speed Switching
- 100% Avalanche Tested
- Pb-Free and RoHS compliance

### Typical Applications

- Switch mode power supply
- AC Drive

### SPECIFICATIONS

**ABSOLUTE MAXIMUM RATINGS** at Ta = 25°C (Note 1, 2, 3, 4)

Parameter	Symbol	Value	Unit
Drain to Source Voltage	V <sub>DSS</sub>	1500	V
Gate to Source Voltage	V <sub>GSS</sub>	±30	V
Drain Current (DC)	I <sub>D</sub>	2.5	A
Drain Current (Pulse) PW≤10μs, duty cycle≤1%	I <sub>DP</sub>	5	A
Power Dissipation	P <sub>D</sub>	2.5	W
		Tc=25°C 140	
Junction Temperature	T <sub>j</sub>	150	°C
Storage Temperature	T <sub>stg</sub>	-55 to +150	°C
Avalanche Energy (Single Pulse) (Note 2)	E <sub>AS</sub>	34	mJ
Avalanche Current (Note 3)	I <sub>AV</sub>	2.5	A

Note 1 : Stresses exceeding those listed in the Maximum Ratings table may damage the device. If any of these limits are exceeded, device functionality should not be assumed, damage may occur and reliability may be affected.

Note 2 : V<sub>DD</sub>=50V, L=10mH, I<sub>AV</sub>=2.5A (Fig.1)

Note 3 : L≤10mH, Single Pulse

### THERMAL RESISTANCE RATINGS

Parameter	Symbol	Value	Unit
Junction to Case Steady State	R <sub>θJC</sub>	0.89	°C/W
Junction to Ambient (Note 4)	R <sub>θJA</sub>	50.0	

Note 4 : Insertion mounted

V <sub>DSS</sub>	R <sub>DS(on)</sub> Max	I <sub>D</sub> Max
1500V	10.5Ω@10V	2.5A

### ELECTRICAL CONNECTION N-Channel

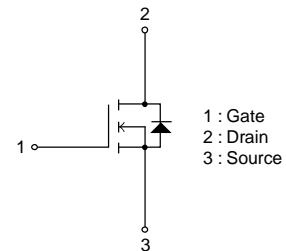

### MARKING

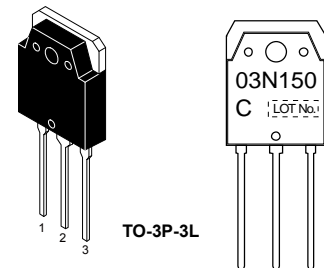

### ORDERING INFORMATION

See detailed ordering and shipping information on page 5 of this data sheet.

# NDTL03N150C

## ELECTRICAL CHARACTERISTICS at Ta = 25°C (Note 5, 6, 7)

Parameter	Symbol	Conditions	Value			Unit	
			min	typ	max		
Drain to Source Breakdown Voltage	V(BR)DSS	ID=10mA, VGS=0V	1500			V	
Zero-Gate Voltage Drain Current	IDSS	VDS=1200V, VGS=0V			1	mA	
Gate to Source Leakage Current	IGSS	VGS=30V, VDS=0V			±100	nA	
Gate Threshold Voltage	VGS(th)	VDS=10V, ID=1mA	2		4	V	
Forward Transconductance	gFS	VDS=20V, ID=1.25A		1.9		S	
Static Drain to Source On-State Resistance	RDS(on)	ID=1.25A, VGS=10V		8	10.5	Ω	
Input Capacitance	Ciss	VDS=30V, f=1MHz		650		pF	
Output Capacitance	Coss				70		pF
Reverse Transfer Capacitance	Crss				20		pF
Turn-ON Delay Time	t <sub>d(on)</sub>	See Fig.2		15		ns	
Rise Time	t <sub>r</sub>			24		ns	
Turn-OFF Delay Time	t <sub>d(off)</sub>			140		ns	
Fall Time	t <sub>f</sub>			47		ns	
Total Gate Charge	Qg				34		nC
Gate to Source Charge	Qgs	VDS=200V, VGS=10V, ID=2.5A		4.7		nC	
Gate to Drain "Miller" Charge	Qgd			15		nC	
Forward Diode Voltage	VSD	IS=2.5A, VGS=0V		0.8	1.5	V	
Reverse Recovery Time	t <sub>rr</sub>	See Fig.3		350		ns	
Reverse Recovery Charge	Q <sub>rr</sub>	IS=2.5A, VGS=0V, di/dt=100A/μs		2220		nC	
Effective Output Capacitance, Energy Related (Note 6)	Co(er)	VGS=0V, VDS=0 to 1200V		18.3		pF	
Effective Output Capacitance, Time Related (Note 7)	Co(tr)				29.6		pF

Note 5 : Product parametric performance is indicated in the Electrical Characteristics for the listed test conditions, unless otherwise noted.

Product performance may not be indicated by the Electrical Characteristics if operated under different conditions.

Note 6 : Co(er) is a fixed capacitance that gives the same stored energy as Coss while VDS is rising from 0 to 80% V(BR)DSS.

Note 7 : Co(tr) is a fixed capacitance that gives the same charging time as Coss while VDS is rising from 0 to 80% V(BR)DSS.

**Fig. 1 Unclamped Inductive Switching Test Circuit**

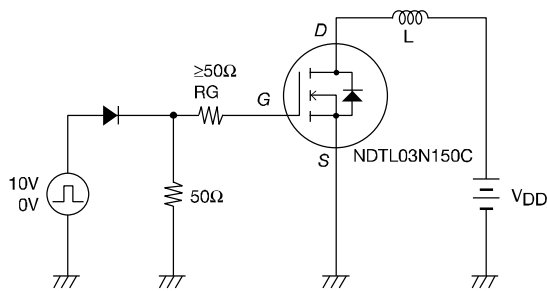

**Fig. 2 Switching Time Test Circuit**

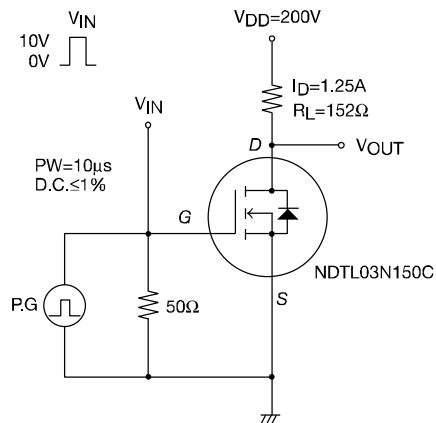

**Fig. 3 Reverse Recovery Time Test Circuit**

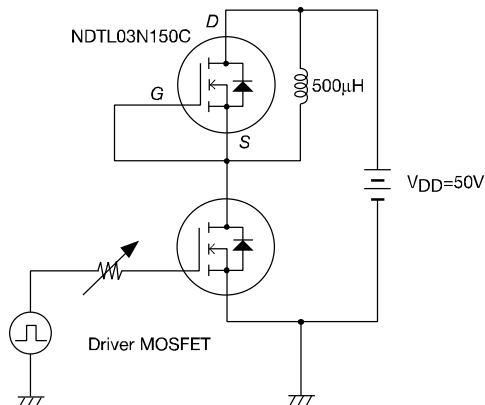

# NDTL03N150C

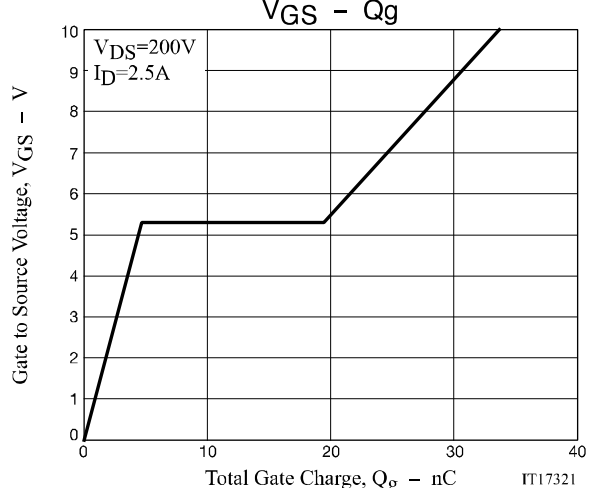
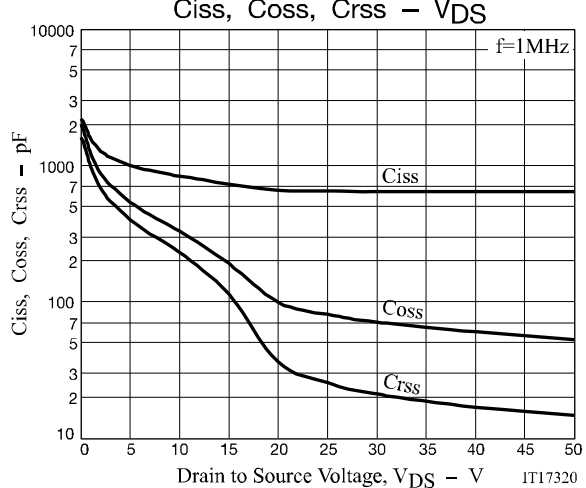
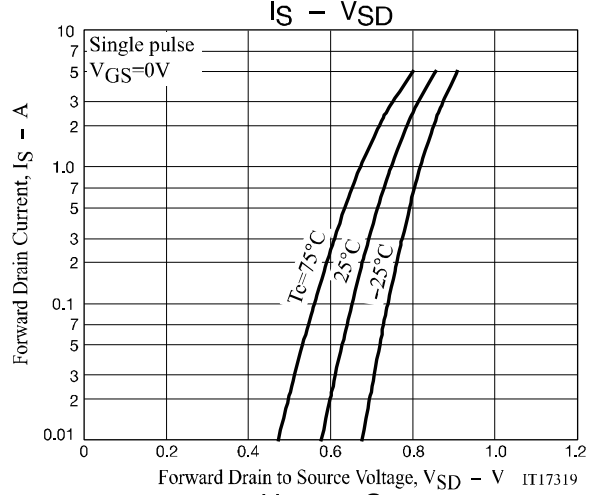
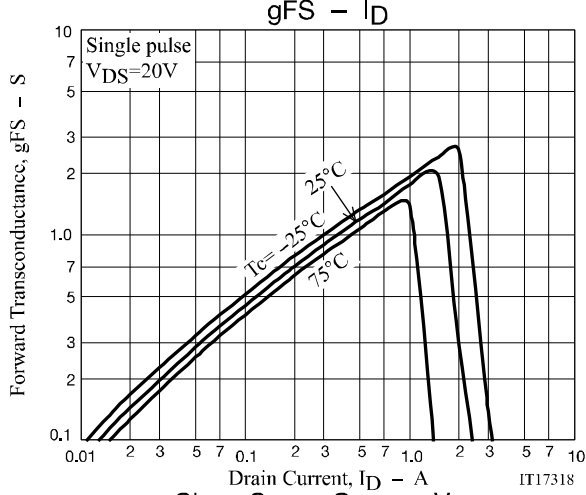
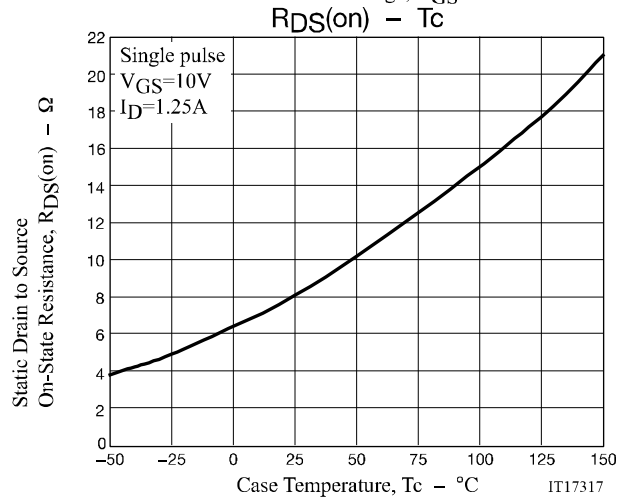
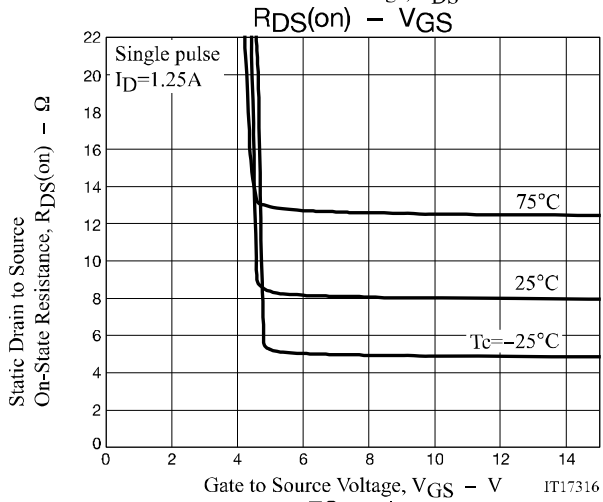
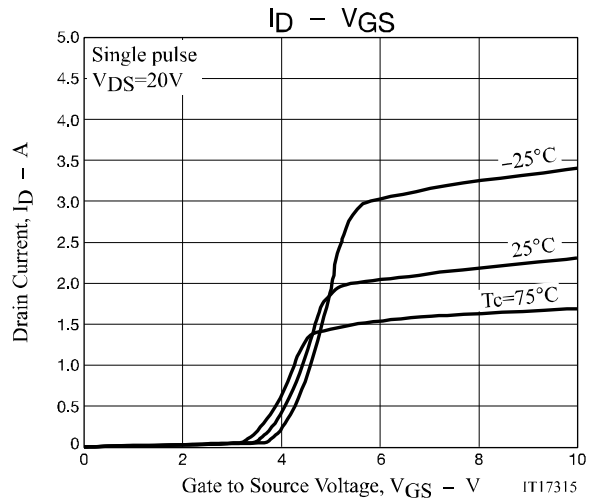
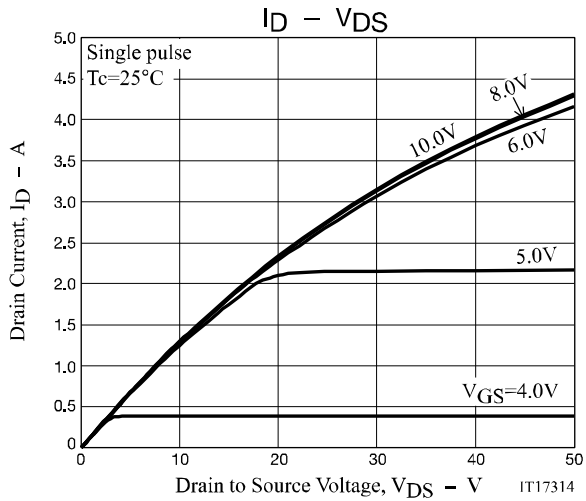

# NDTL03N150C

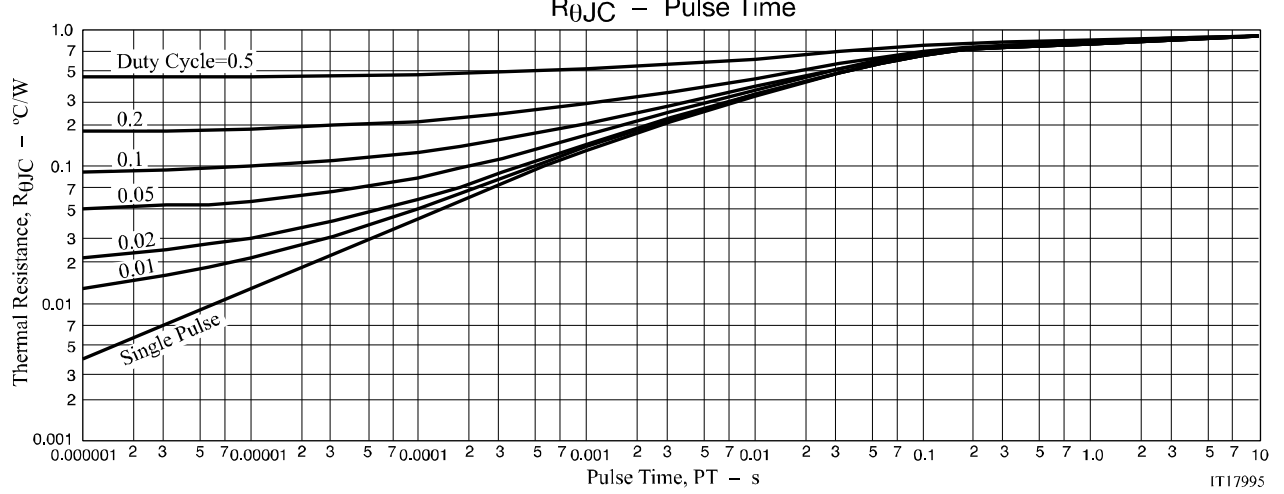
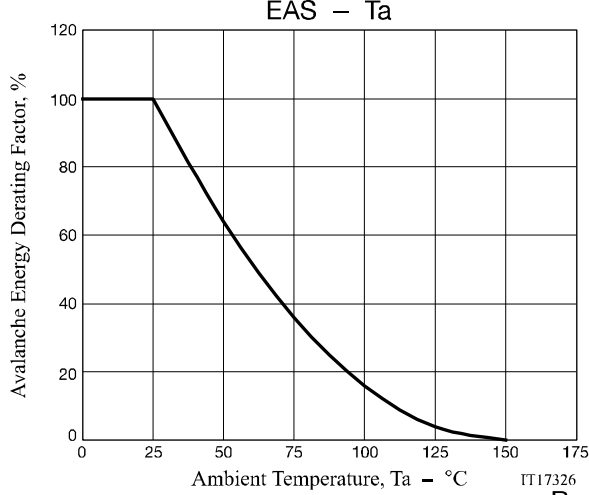
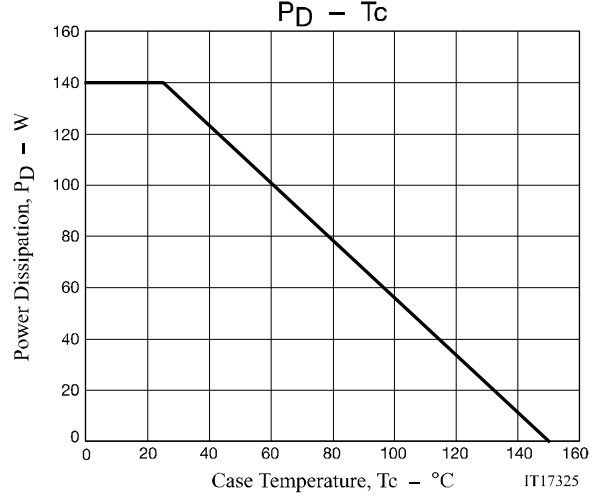
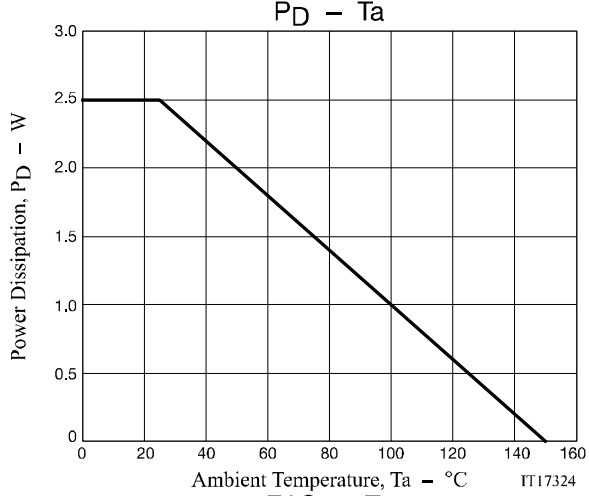
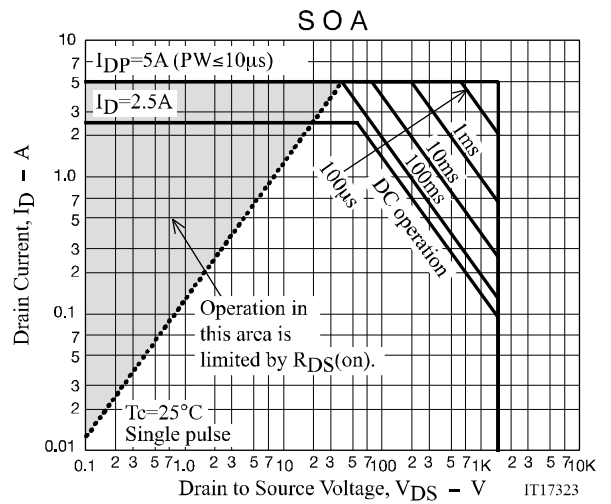
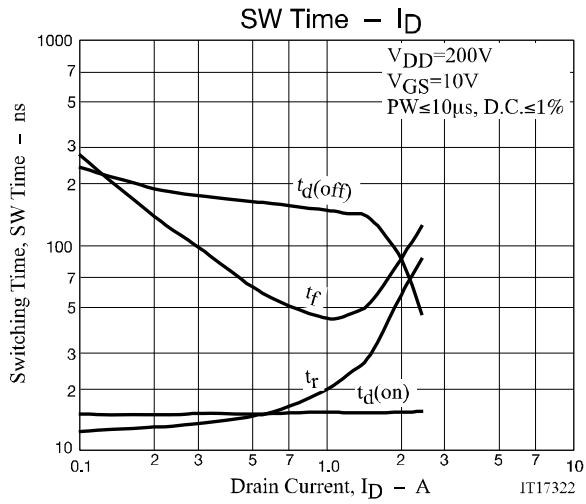

# NDTL03N150C

## PACKAGE DIMENSIONS

unit : mm

TO-3P-3L  
CASE 340AF  
ISSUE A

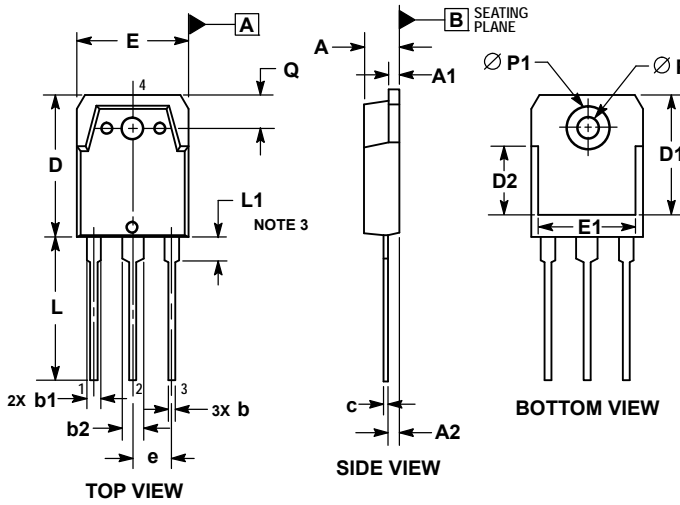

- NOTES:
1. DIMENSIONING AND TOLERANCING PER ASME Y14.5M, 1994.
  2. CONTROLLING DIMENSION: MILLIMETERS
  3. CONTOUR UNCONTROLLED IN THIS AREA.
  4. DIMENSIONS D AND E DO NOT INCLUDE MOLD FLASH OR GATE PROTRUSIONS, MOLD FLASH OR GATE PROTRUSIONS NOT TO EXCEED 0.13 PER SIDE. THESE DIMENSIONS ARE TO BE MEASURED AT THE OUTERMOST EXTREME OF THE PLASTIC BODY.
  5. DIMENSIONS b1 AND b2 DO NOT INCLUDE DAMBAR PROTRUSION. DAMBAR PROTRUSION SHALL NOT EXCEED 0.10.

DIM	MILLIMETERS		
	MIN	NOM	MAX
A	4.60	4.80	5.00
A1	1.45	1.50	1.65
A2	1.20	1.40	1.60
b	0.80	1.00	1.20
b1	1.80	2.00	2.20
b2	2.80	3.00	3.20
c	0.55	0.60	0.75
D	19.70	19.90	20.10
D1	16.56	16.76	16.96
D2	9.80	10.00	10.20
E	15.40	15.60	15.80
E1	13.40	13.60	13.80
e	5.15	5.45	5.75
L	19.80	20.00	20.20
L1	3.30	3.50	3.70
P	3.00	3.20	3.40
P1	6.80	7.00	7.20
Q	4.80	5.00	5.20

- 1 : Gate
- 2 : Drain
- 3 : Source

## GENERIC MARKING DIAGRAM\*

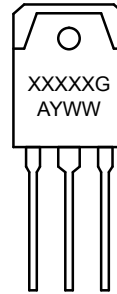

- XXXXX = Specific Device Code
- A = Assembly Location
- Y = Year
- WW = Work Week
- G = Pb-Free Package

\*This information is generic. Please refer to device data sheet for actual part marking. Pb-Free indicator, "G", may or not be present.

## ORDERING INFORMATION

Device	Marking	Package	Shipping (Qty / Packing)
NDTL03N150CG	03N150C	TO-3P-3L (Pb-Free)	30 / Tube

Note on usage : Since the NDTL03N150C is a MOSFET product, please avoid using this device in the vicinity of highly charged objects.

ON Semiconductor and the ON logo are registered trademarks of Semiconductor Components Industries, LLC (SCILLC) or its subsidiaries in the United States and/or other countries. SCILLC owns the rights to a number of patents, trademarks, copyrights, trade secrets, and other intellectual property. A listing of SCILLC's product/patent coverage may be accessed at [www.onsemi.com/site/pdf/Patent-Marking.pdf](http://www.onsemi.com/site/pdf/Patent-Marking.pdf). SCILLC reserves the right to make changes without further notice to any products herein. SCILLC makes no warranty, representation or guarantee regarding the suitability of its products for any particular purpose, nor does SCILLC assume any liability arising out of the application or use of any product or circuit, and specifically disclaims any and all liability, including without limitation special, consequential or incidental damages. "Typical" parameters which may be provided in SCILLC data sheets and/or specifications can and do vary in different applications and actual performance may vary over time. All operating parameters, including "Typicals" must be validated for each customer application by customer's technical experts. SCILLC does not convey any license under its patent rights nor the rights of others. SCILLC products are not designed, intended, or authorized for use as components in systems intended for surgical implant into the body, or other applications intended to support or sustain life, or for any other application in which the failure of the SCILLC product could create a situation where personal injury or death may occur. Should Buyer purchase or use SCILLC products for any such unintended or unauthorized application, Buyer shall indemnify and hold SCILLC and its officers, employees, subsidiaries, affiliates, and distributors harmless against all claims, costs, damages, and expenses, and reasonable attorney fees arising out of, directly or indirectly, any claim of personal injury or death associated with such unintended or unauthorized use, even if such claim alleges that SCILLC was negligent regarding the design or manufacture of the part. SCILLC is an Equal Opportunity/Affirmative Action Employer. This literature is subject to all applicable copyright laws and is not for resale in any manner.

# Mouser Electronics

Authorized Distributor

Click to View Pricing, Inventory, Delivery & Lifecycle Information:

[ON Semiconductor:](#)

[NDTL03N150CG](#)