

# 2N6394 Series

## Silicon Controlled Rectifiers Reverse Blocking Thyristors

Designed primarily for half-wave ac control applications, such as motor controls, heating controls and power supplies.

### Features

- Glass Passivated Junctions with Center Gate Geometry for Greater Parameter Uniformity and Stability
- Small, Rugged, Thermowatt Construction for Low Thermal Resistance, High Heat Dissipation and Durability
- Blocking Voltage to 800 V
- These are Pb-Free Devices

### MAXIMUM RATINGS<sup>†</sup> (T<sub>J</sub> = 25°C unless otherwise noted)

Rating	Symbol	Value	Unit
Peak Repetitive Off-State Voltage (Note 1) (T <sub>J</sub> = -40 to 125°C, Sine Wave, 50 to 60 Hz, Gate Open)	V <sub>DRM</sub> , V <sub>RRM</sub>	50 100 400 800	V
On-State RMS Current (180° Conduction Angles; T <sub>C</sub> = 90°C)	I <sub>T(RMS)</sub>	12	A
Peak Non-Repetitive Surge Current (1/2 Cycle, Sine Wave, 60 Hz, T <sub>J</sub> = 90°C)	I <sub>TSM</sub>	100	A
Circuit Fusing (t = 8.3 ms)	I <sup>2</sup> t	40	A <sup>2</sup> s
Forward Peak Gate Power (Pulse Width ≤ 1.0 μs, T <sub>C</sub> = 90°C)	P <sub>GM</sub>	20	W
Forward Average Gate Power (t = 8.3 ms, T <sub>C</sub> = 90°C)	P <sub>G(AV)</sub>	0.5	W
Forward Peak Gate Current (Pulse Width ≤ 1.0 μs, T <sub>C</sub> = 90°C)	I <sub>GM</sub>	2.0	A
Operating Junction Temperature Range	T <sub>J</sub>	-40 to +125	°C
Storage Temperature Range	T <sub>stg</sub>	-40 to +150	°C

### MAXIMUM RATINGS<sup>†</sup> (T<sub>J</sub> = 25°C unless otherwise noted)

Rating	Symbol	Max	Unit
Thermal Resistance, Junction-to-Case	R <sub>θJC</sub>	2.0	°C/W
Maximum Lead Temperature for Soldering Purposes 1/8" from Case for 10 Seconds	T <sub>L</sub>	260	°C

<sup>†</sup>Indicates JEDEC Registered Data

Stresses exceeding Maximum Ratings may damage the device. Maximum Ratings are stress ratings only. Functional operation above the Recommended Operating Conditions is not implied. Extended exposure to stresses above the Recommended Operating Conditions may affect device reliability.

1. V<sub>DRM</sub> and V<sub>RRM</sub> for all types can be applied on a continuous basis. Ratings apply for zero or negative gate voltage; however, positive gate voltage shall not be applied concurrent with negative potential on the anode. Blocking voltages shall not be tested with a constant current source such that the voltage ratings of the devices are exceeded.



ON Semiconductor®

<http://onsemi.com>

SCRs  
12 AMPERES RMS  
50 thru 800 VOLTS



### MARKING DIAGRAM

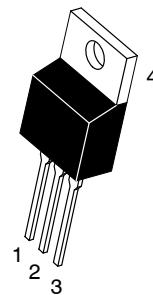

TO-220AB  
CASE 221A  
STYLE 3

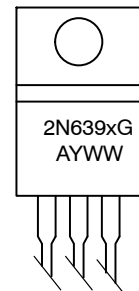

2N639x = Device Code  
x = 4, 5, 7, or 9  
G = Pb-Free Package  
A = Assembly Location  
Y = Year  
WW = Work Week

### PIN ASSIGNMENT

Pin	Assignment
1	Cathode
2	Anode
3	Gate
4	Anode

### ORDERING INFORMATION

See detailed ordering and shipping information in the package dimensions section on page 4 of this data sheet.

# 2N6394 Series

## ELECTRICAL CHARACTERISTICS (T<sub>C</sub> = 25°C unless otherwise noted.)

Characteristic	Symbol	Min	Typ	Max	Unit
----------------	--------	-----	-----	-----	------

### OFF CHARACTERISTICS

†Peak Repetitive Forward or Reverse Blocking Current (V <sub>AK</sub> = Rated V <sub>DRM</sub> or V <sub>RRM</sub> , Gate Open)	I <sub>DRM</sub> , I <sub>RRM</sub>	T <sub>J</sub> = 25°C	-	-	10	μA
		T <sub>J</sub> = 125°C	-	-	2.0	mA

### ON CHARACTERISTICS

†Peak Forward On-State Voltage (Note 2) (I <sub>TM</sub> = 24 A Peak)	V <sub>TM</sub>	-	1.7	2.2	V
†Gate Trigger Current (Continuous dc) (V <sub>D</sub> = 12 Vdc, R <sub>L</sub> = 100 Ohms)	I <sub>GT</sub>	-	5.0	30	mA
†Gate Trigger Voltage (Continuous dc) (V <sub>D</sub> = 12 Vdc, R <sub>L</sub> = 100 Ohms)	V <sub>GT</sub>	-	0.7	1.5	V
Gate Non-Trigger Voltage (V <sub>D</sub> = 12 Vdc, R <sub>L</sub> = 100 Ohms, T <sub>J</sub> = 125°C)	V <sub>GD</sub>	0.2	-	-	V
†Holding Current (V <sub>D</sub> = 12 Vdc, Initiating Current = 200 mA, Gate Open)	I <sub>H</sub>	-	6.0	50	mA
Turn-On Time (I <sub>TM</sub> = 12 A, I <sub>GT</sub> = 40 mAdc, V <sub>D</sub> = Rated V <sub>DRM</sub> )	t <sub>gt</sub>	-	1.0	2.0	μs
Turn-Off Time (V <sub>D</sub> = Rated V <sub>DRM</sub> )	t <sub>q</sub>	(I <sub>TM</sub> = 12 A, I <sub>R</sub> = 12 A) (I <sub>TM</sub> = 12 A, I <sub>R</sub> = 12 A, T <sub>J</sub> = 125°C)	-	15 35	- μs

### DYNAMIC CHARACTERISTICS

Critical Rate-of-Rise of Off-State Voltage Exponential (V <sub>D</sub> = Rated V <sub>DRM</sub> , T <sub>J</sub> = 125°C)	dv/dt	-	50	-	V/μs
--	-------	---	----	---	------

†Indicates JEDEC Registered Data

2. Pulse Test: Pulse Width ≤ 300 μsec, Duty Cycle ≤ 2%.

## Voltage Current Characteristic of SCR

Symbol	Parameter
V <sub>DRM</sub>	Peak Repetitive Off State Forward Voltage
I <sub>DRM</sub>	Peak Forward Blocking Current
V <sub>RRM</sub>	Peak Repetitive Off State Reverse Voltage
I <sub>RRM</sub>	Peak Reverse Blocking Current
V <sub>TM</sub>	Peak On State Voltage
I <sub>H</sub>	Holding Current

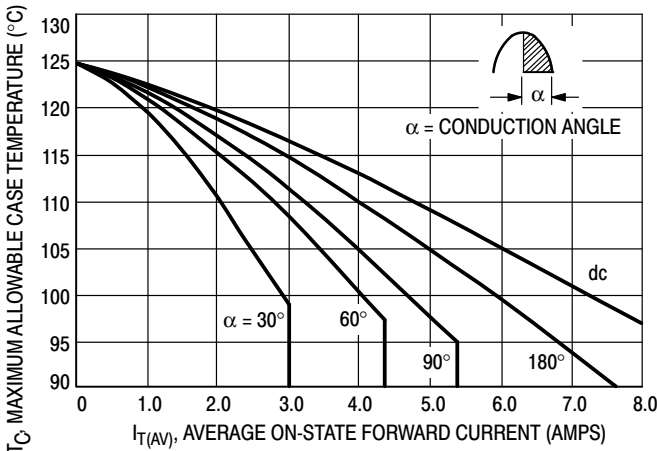
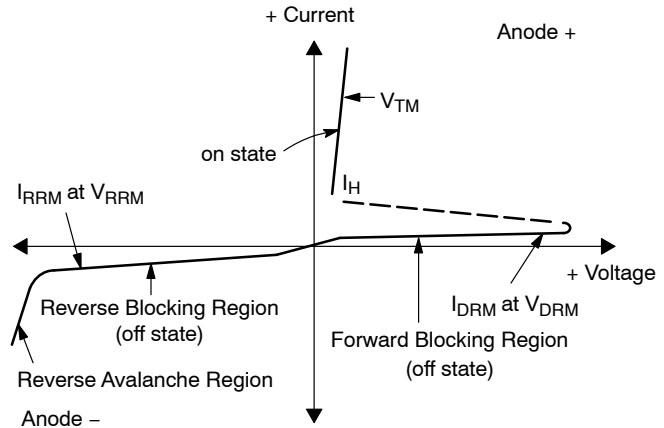

Figure 1. Current Derating

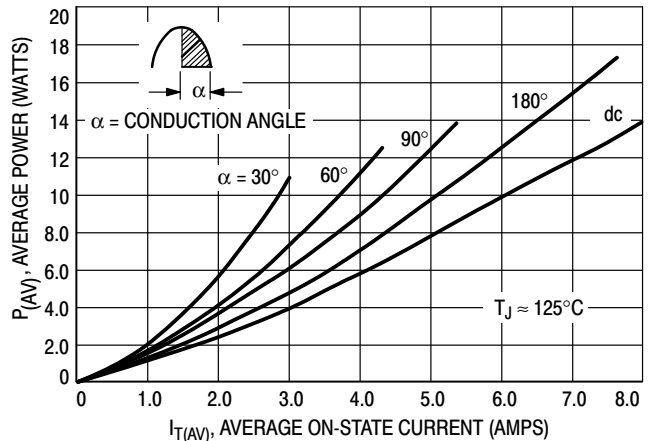
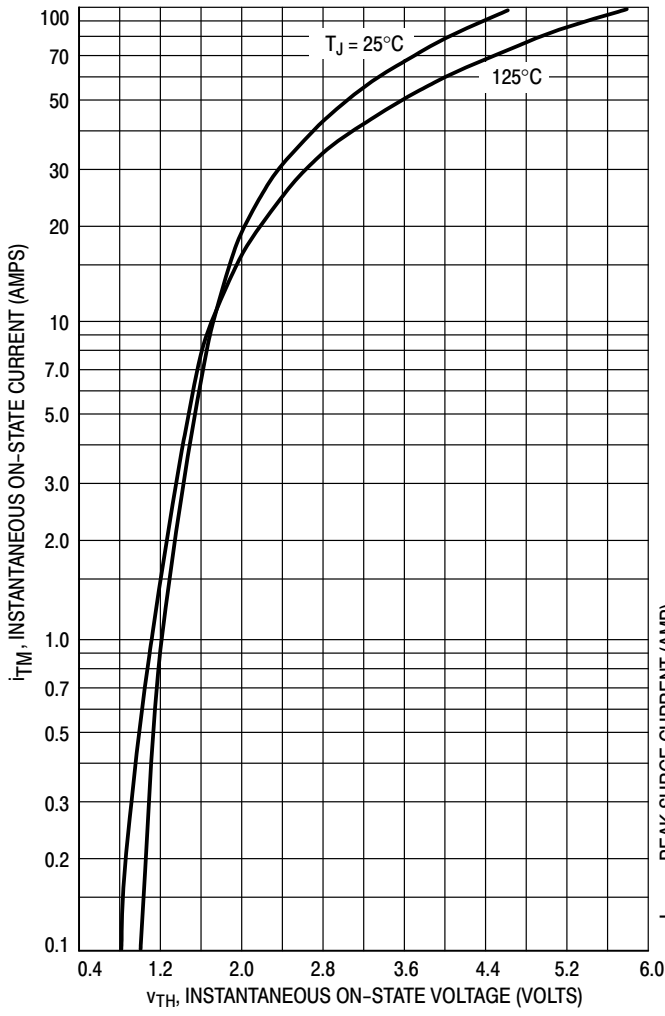
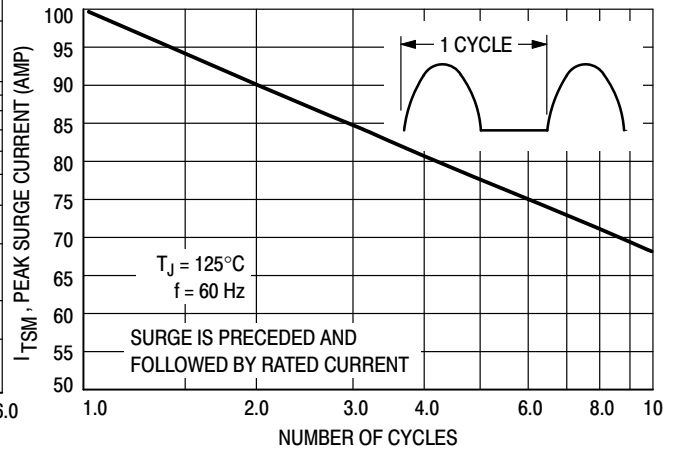

Figure 2. Maximum On-State Power Dissipation

# 2N6394 Series



**Figure 3. On-State Characteristics**



**Figure 4. Maximum Non-Repetitive Surge Current**

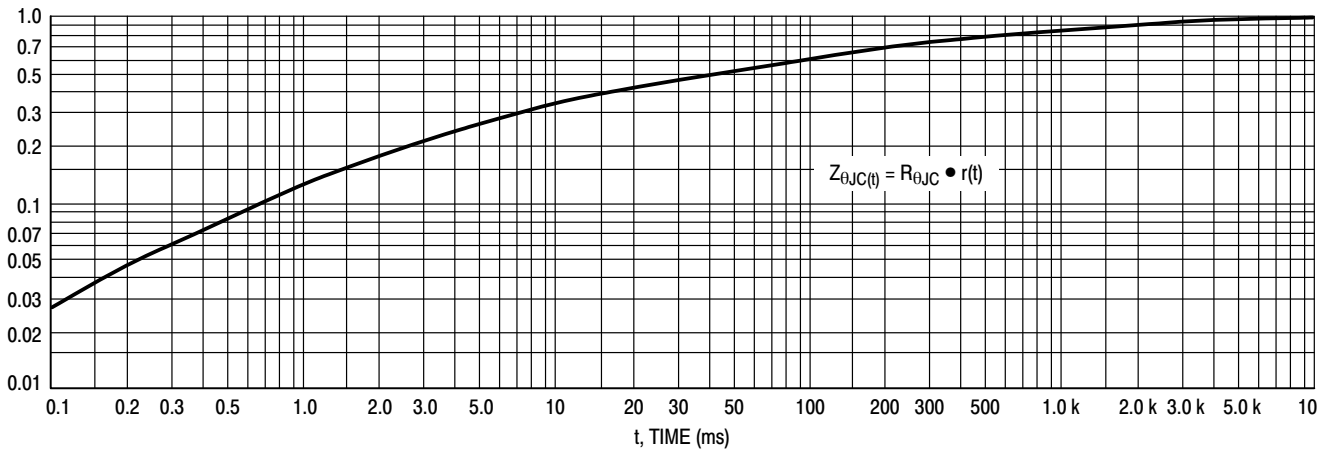

**Figure 5. Thermal Response**

# 2N6394 Series

## TYPICAL CHARACTERISTICS

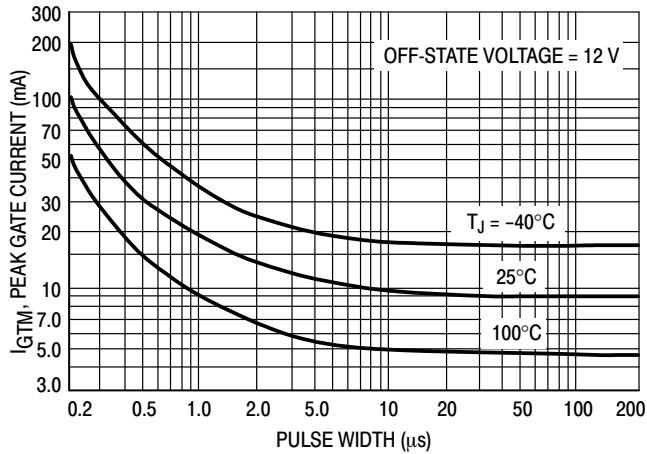

**Figure 6. Typical Gate Trigger Current versus Pulse Width**

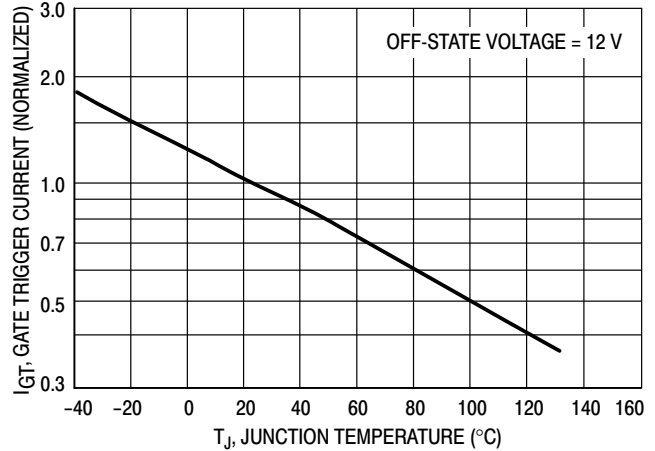

**Figure 7. Typical Gate Trigger Current versus Temperature**

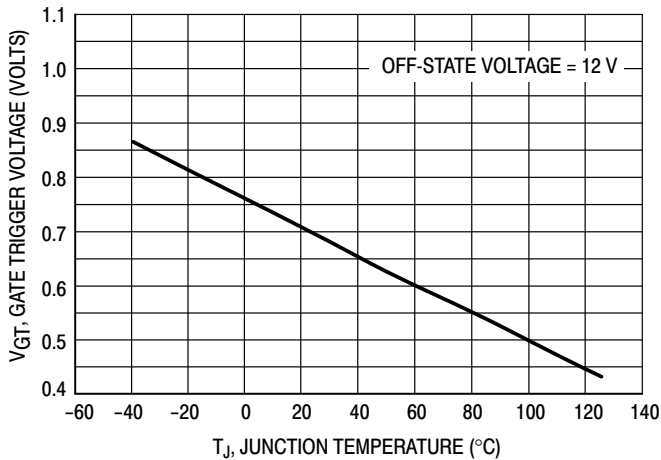

**Figure 8. Typical Gate Trigger Voltage versus Temperature**

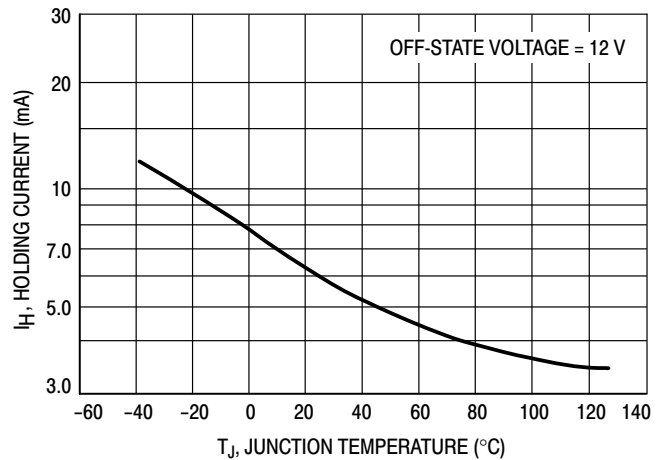

**Figure 9. Typical Holding Current versus Temperature**

## ORDERING INFORMATION

Device	Package	Shipping**
2N6394G	TO-220AB (Pb-Free)	500 Units / Bulk
2N6394TG		50 Units / Rail
2N6395G		500 Units / Bulk
2N6397G		500 Units / Bulk
2N6397TG		50 Units / Rail
2N6399G		500 Units / Bulk
2N6399TG		50 Units / Rail

\*\*For information on tape and reel specifications, including part orientation and tape sizes, please refer to our Tape and Reel Packaging Specifications Brochure, BRD8011/D.

# 2N6394 Series

## PACKAGE DIMENSIONS

TO-220AB  
CASE 221A-07  
ISSUE AA

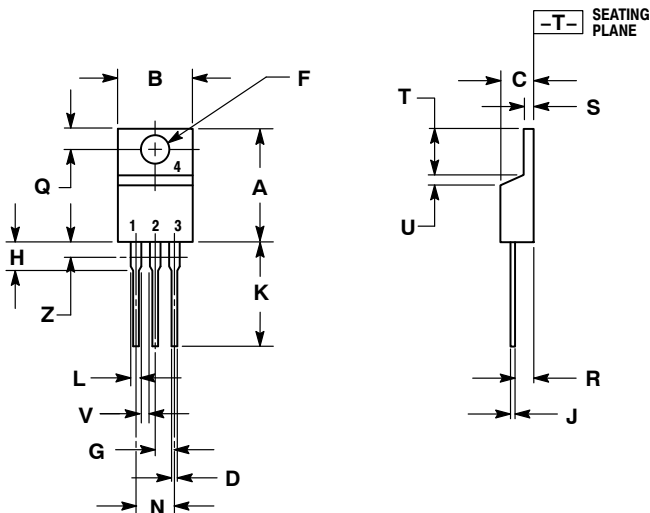

- NOTES:
1. DIMENSIONING AND TOLERANCING PER ANSI Y14.5M, 1982.
  2. CONTROLLING DIMENSION: INCH.
  3. DIMENSION Z DEFINES A ZONE WHERE ALL BODY AND LEAD IRREGULARITIES ARE ALLOWED.

DIM	INCHES		MILLIMETERS	
	MIN	MAX	MIN	MAX
A	0.570	0.620	14.48	15.75
B	0.380	0.405	9.66	10.28
C	0.160	0.190	4.07	4.82
D	0.025	0.035	0.64	0.88
F	0.142	0.147	3.61	3.73
G	0.095	0.105	2.42	2.66
H	0.110	0.155	2.80	3.93
J	0.014	0.022	0.36	0.55
K	0.500	0.562	12.70	14.27
L	0.045	0.060	1.15	1.52
N	0.190	0.210	4.83	5.33
Q	0.100	0.120	2.54	3.04
R	0.080	0.110	2.04	2.79
S	0.045	0.055	1.15	1.39
T	0.235	0.255	5.97	6.47
U	0.000	0.050	0.00	1.27
V	0.045	---	1.15	---
Z	---	0.080	---	2.04

- STYLE 3:
- PIN 1. CATHODE
  2. ANODE
  3. GATE
  4. ANODE

ON Semiconductor and are registered trademarks of Semiconductor Components Industries, LLC (SCILLC). SCILLC owns the rights to a number of patents, trademarks, copyrights, trade secrets, and other intellectual property. A listing of SCILLC's product/patent coverage may be accessed at [www.onsemi.com/site/pdf/Patent-Marking.pdf](http://www.onsemi.com/site/pdf/Patent-Marking.pdf). SCILLC reserves the right to make changes without further notice to any products herein. SCILLC makes no warranty, representation or guarantee regarding the suitability of its products for any particular purpose, nor does SCILLC assume any liability arising out of the application or use of any product or circuit, and specifically disclaims any and all liability, including without limitation special, consequential or incidental damages. "Typical" parameters which may be provided in SCILLC data sheets and/or specifications can and do vary in different applications and actual performance may vary over time. All operating parameters, including "Typicals" must be validated for each customer application by customer's technical experts. SCILLC does not convey any license under its patent rights nor the rights of others. SCILLC products are not designed, intended, or authorized for use as components in systems intended for surgical implant into the body, or other applications intended to support or sustain life, or for any other application in which the failure of the SCILLC product could create a situation where personal injury or death may occur. Should Buyer purchase or use SCILLC products for any such unintended or unauthorized application, Buyer shall indemnify and hold SCILLC and its officers, employees, subsidiaries, affiliates, and distributors harmless against all claims, costs, damages, and expenses, and reasonable attorney fees arising out of, directly or indirectly, any claim of personal injury or death associated with such unintended or unauthorized use, even if such claim alleges that SCILLC was negligent regarding the design or manufacture of the part. SCILLC is an Equal Opportunity/Affirmative Action Employer. This literature is subject to all applicable copyright laws and is not for resale in any manner.

### PUBLICATION ORDERING INFORMATION

**LITERATURE FULFILLMENT:**  
Literature Distribution Center for ON Semiconductor  
P.O. Box 5163, Denver, Colorado 80217 USA  
**Phone:** 303-675-2175 or 800-344-3860 Toll Free USA/Canada  
**Fax:** 303-675-2176 or 800-344-3867 Toll Free USA/Canada  
**Email:** [orderlit@onsemi.com](mailto:orderlit@onsemi.com)

**N. American Technical Support:** 800-282-9855 Toll Free  
USA/Canada  
**Europe, Middle East and Africa Technical Support:**  
Phone: 421 33 790 2910  
**Japan Customer Focus Center**  
Phone: 81-3-5817-1050

**ON Semiconductor Website:** [www.onsemi.com](http://www.onsemi.com)  
**Order Literature:** <http://www.onsemi.com/orderlit>

For additional information, please contact your local Sales Representative

# Mouser Electronics

Authorized Distributor

Click to View Pricing, Inventory, Delivery & Lifecycle Information:

## ON Semiconductor:

[2N6394](#) [2N6394G](#) [2N6395](#) [2N6397](#) [2N6397T](#) [2N6397TG](#) [2N6399](#) [2N6399G](#) [2N6395G](#) [2N6397G](#) [2N6399TG](#)  
[2N6394TG](#)