



The Future of Analog IC Technology®

# EV100L-N-00A Offline Inductor-Less Regulator EV Board

## DESCRIPTION

The MP100L is a compact, inductor-less, good-efficiency, off-line regulator. It steps down the AC line voltage to an adjustable DC output. It is a simple solution to provide a bias voltage to ICs in off-line applications. Its integrated smart-control system uses AC line power only when necessary, thus minimizing device losses to achieve good efficiency. This device can help system designs meet new standby power specifications.

The MP100L provides various protections, such as Thermal Shutdown (TSD), VD Over Voltage Protection (OVP), VD Short to GND Protection, Over Load Protection (OLP), Short Circuit Protection (SCP).

The MP100L is available in SOIC8E package.

## ELECTRICAL SPECIFICATION

| Parameter      | Symbol    | Value  | Units |
|----------------|-----------|--------|-------|
| Supply Voltage | $V_{IN}$  | 85~265 | VAC   |
| Output Voltage | $V_{OUT}$ | 12     | V     |
| Output Current | $I_{OUT}$ | 20     | mA    |

## FEATURES

- Universal AC Input (85VAC-to-305VAC)
- Inductor-Less
- Less than 100mW Standby Power
- Excellent EMI
- Low BOM Cost
- Smart Control to Maximum Efficiency
- Adjustable Output Voltage from 1.5V to 15V
- Good Line and Load Regulation
- Thermal Shutdown Protection
- Short-Circuit Protection
- Provide Power-Good Signal

## APPLICATIONS

- Wall Switches and Dimmers
- Z-Wave Device and ZigBee Device for Home Automation
- Standby Power for General Off-line Applications

All MPS parts are lead-free and adhere to the RoHS directive. For MPS green status, please visit MPS website under Quality Assurance. "MPS" and "The Future of Analog IC Technology" are Registered Trademarks of Monolithic Power Systems, Inc.

## EV100L-N-00A EVALUATION BOARD



( L x W x H ) 21mm x 14mm x 20mm

| Board Number | MPS IC Number |
|--------------|---------------|
| EV100L-N-00A | MP100GN       |

## EVALUATION BOARD SCHEMATIC

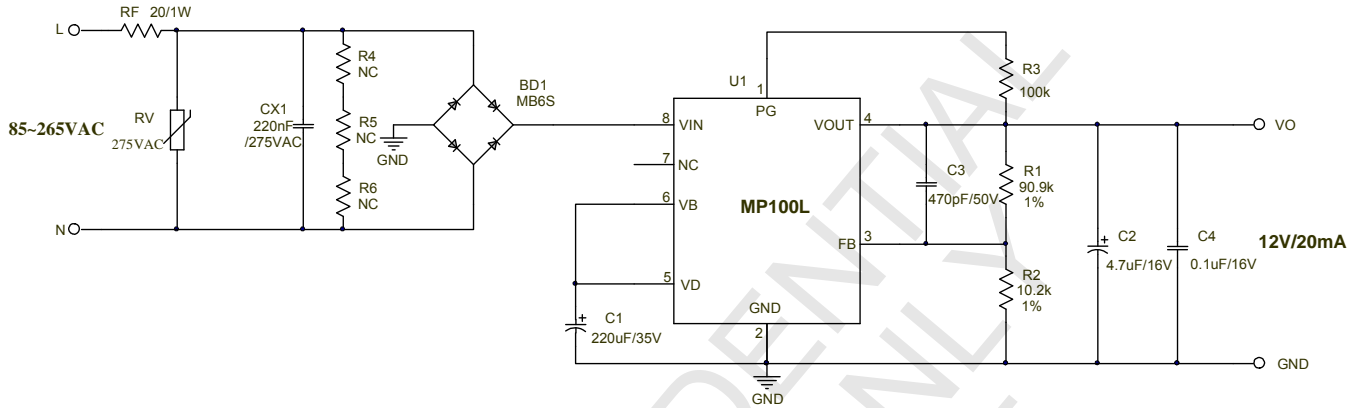

V<sub>OUT</sub> can be adjusted by choosing the value of R1 and R2, the relationship of them is:

$$V_{OUT} = 1.235V * (1 + R1/R2)$$

For example, to get 5V output voltage, we can choose, R4=10.2k, R5=30.9k.

The maximum output power of MP100L Vs input voltage is depicted by following chart for 12V, 5V and 3.3V output applications respectively.

The test condition is: in open frame, full bridge rectifier, ambient temperature is 25 °C, the temperature rise of MP100L is less than 60 °C on the test board.

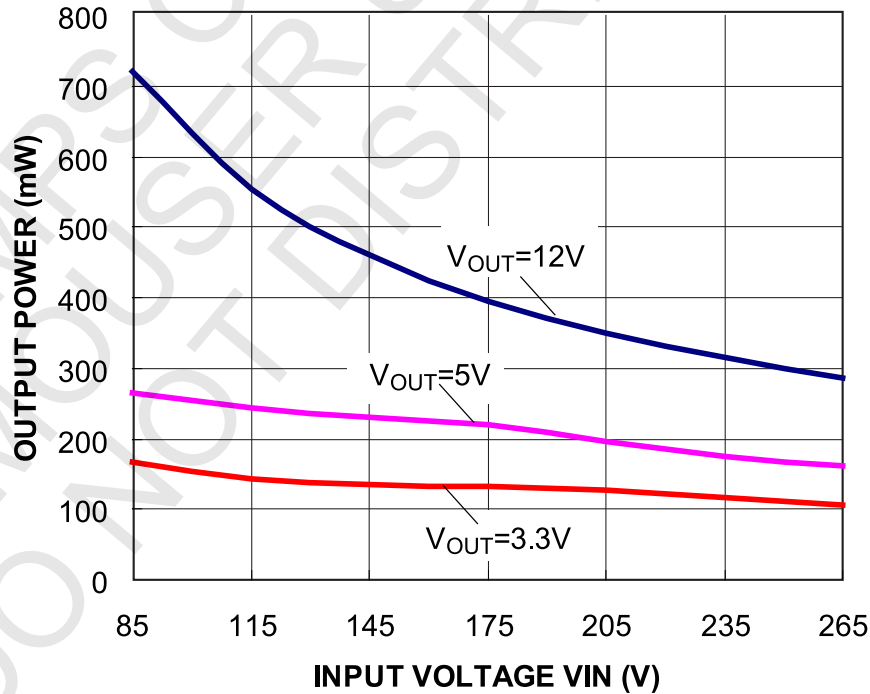

**EV100L-N-00A BILL OF MATERIAL**

| Qty | Ref | Value  | Description                 | Package | Manufacture          | Manufacturer_PN    |
|-----|-----|--------|-----------------------------|---------|----------------------|--------------------|
| 1   | BD1 | MB6S   | Diode;600V;0.5A;            | SOIC-4  | TaiWan Semiconductor | MB6S               |
| 1   | C1  | 220uF  | Electrolytic Capacitor;35V; | DIP     | Jianghai             | CD110-35V220       |
| 1   | C2  | 4.7uF  | Electrolytic Capacitor;16V; | DIP     | Nichicon             | UMA1C4R7MCD2       |
| 1   | C3  | 470pF  | Ceramic Capacitor;50V;C0G;  | 0603    | Murata               | GRM1885C1H471JA01D |
| 1   | C4  | 100nF  | Ceramic Capacitor;16V;X7R;  | 0603    | Murata               | GRM188R71C104KA01D |
| 1   | CX1 | 220nF  | Film Capacitor;275V;10%     | DIP     | Kaili                | PX24K3IC59L270D9R  |
| 1   | R1  | 90.9kΩ | Film Resistor;1%;           | 0603    | Yageo                | RC0603FR-0790K9L   |
| 1   | R2  | 10.2kΩ | Film Resistor;1%;           | 0603    | Yageo                | RC0603FR-0710K2L   |
| 1   | R3  | 100kΩ  | Film Resistor;1%;           | 0603    | Yageo                | RC0603FR-07100KL   |
| 1   | RF  | 20Ω    | Fuse Resistor;5%;1W         | DIP     | Great Electronics    | 1WSJT-52-20R       |
| 1   | RV  | 275Vac | TVR10431KSY, 430V(1 mA);    | DIP     | TKS                  | TVR10431KSY        |
| 1   | U1  | MP100L | Offline Regulator           | SOIC8E  | MPS                  | MP100LGN R1        |

## EVB TEST RESULTS

Performance waveforms are tested on the evaluation board.

$V_{OUT} = 12V$ ,  $I_{OUT} = 20mA$ ,  $T_A = 25^\circ C$ , unless otherwise noted.

Efficiency vs. Load

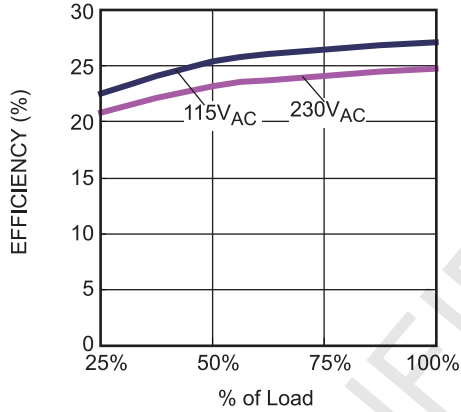

No Load Power vs. Input Voltage

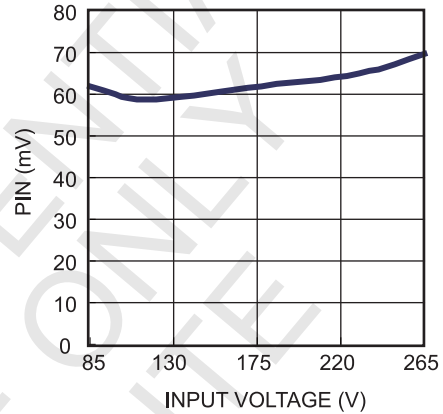

Input Power Start Up

$V_{IN} = 115V_{AC}$

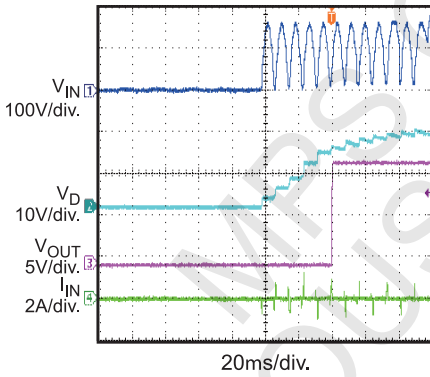

Input Power Start Up

$V_{IN} = 230V_{AC}$

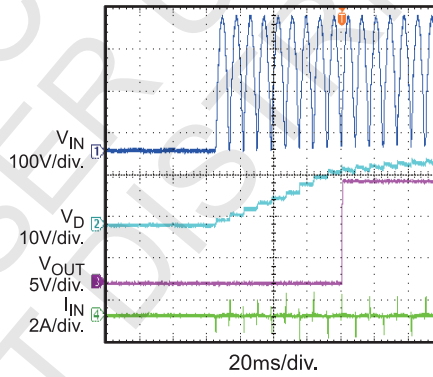

Steady State

$V_{IN} = 115V_{AC}$

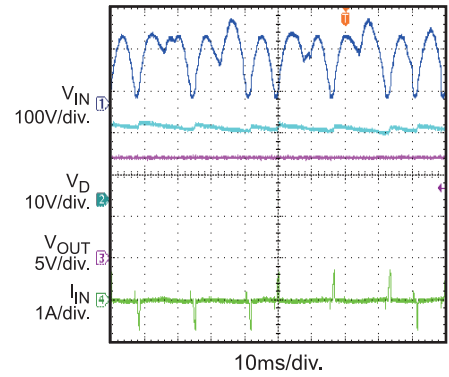

Steady State

$V_{IN} = 230V_{AC}$

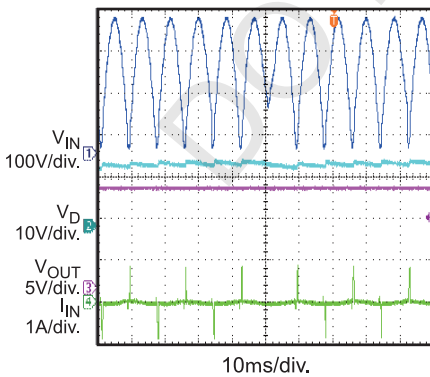

Input Power Shut Down

$V_{IN} = 115V_{AC}$

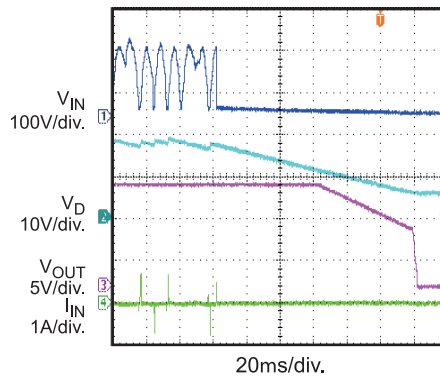

Input Power Shut Down

$V_{IN} = 230V_{AC}$

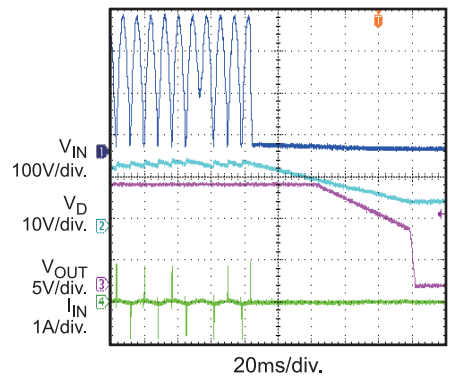

**EVB TEST RESULTS** *(continued)*

Performance waveforms are tested on the evaluation board.

$V_{OUT} = 12V$ ,  $I_{OUT} = 20mA$ ,  $T_A = 25^{\circ}C$ , unless otherwise noted.

**Output Ripple**

$V_{IN} = 115V_{AC}$

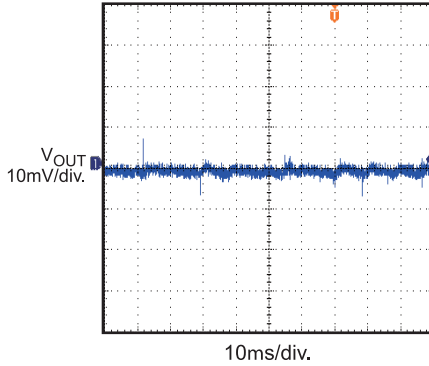

**Output Ripple**

$V_{IN} = 230V_{AC}$

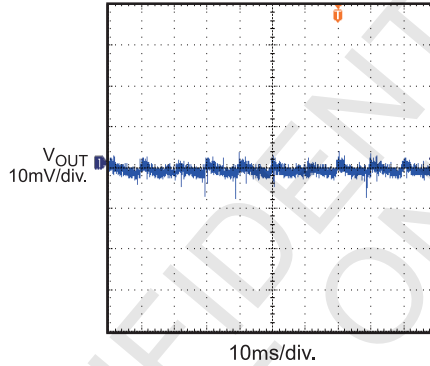

**Load Transient**

$V_{IN} = 115V_{AC}$ , 0 to 20mA

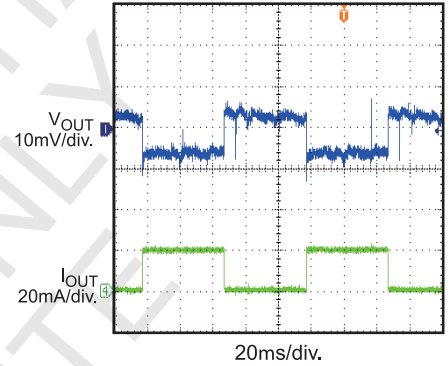

**Load Transient**

$V_{IN} = 230V_{AC}$ , 0 to 20mA

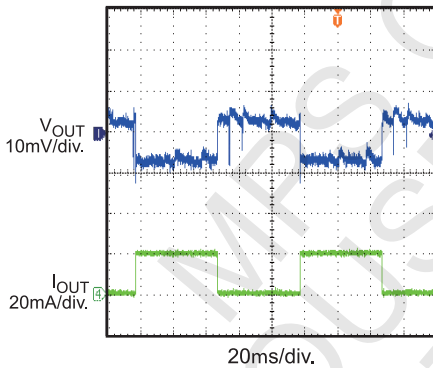

**Over Load Protection Entry**

$V_{IN} = 115V_{AC}$

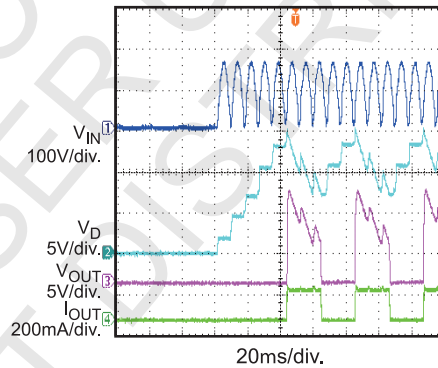

**Over Load Protection Entry**

$V_{IN} = 230V_{AC}$

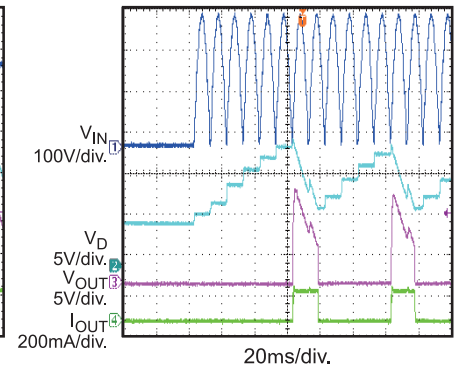

**Over Load Protection Recovery**

$V_{IN} = 115V_{AC}$

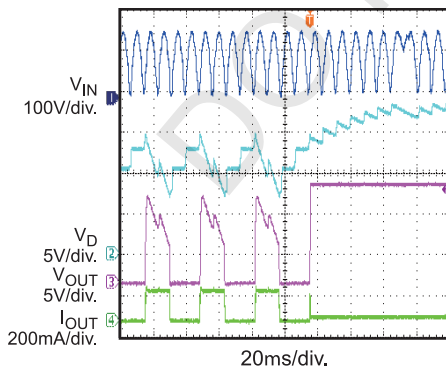

**Over Load Protection Recovery**

$V_{IN} = 230V_{AC}$

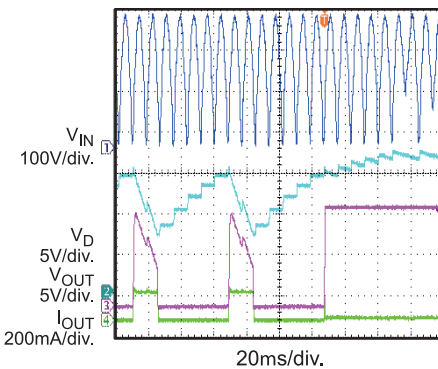

**Short Circuit Protection Entry**

$V_{IN} = 115V_{AC}$

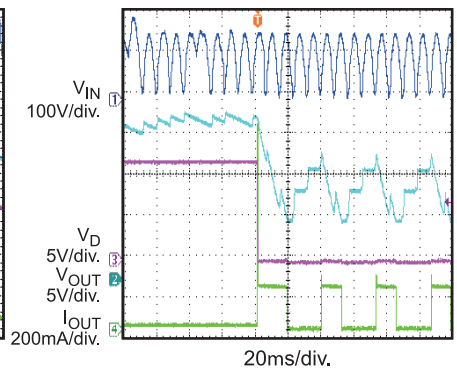

**EVB TEST RESULTS** *(continued)*

Performance waveforms are tested on the evaluation board.

$V_{OUT} = 12V$ ,  $I_{OUT} = 20mA$ ,  $T_A = 25^{\circ}C$ , unless otherwise noted.

**Short Circuit Protection Entry**

$V_{IN} = 230V_{AC}$

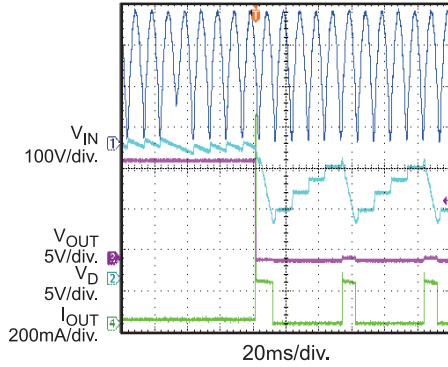

**Short Circuit Protection Entry**

$V_{IN} = 115V_{AC}$

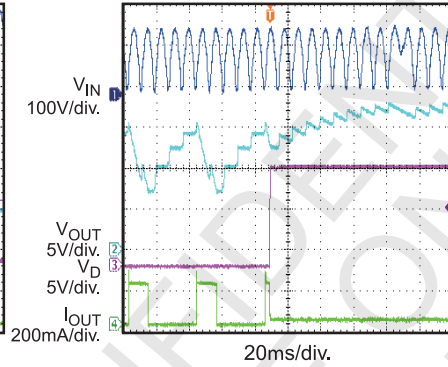

**Short Circuit Protection Recovery**

$V_{IN} = 230V_{AC}$

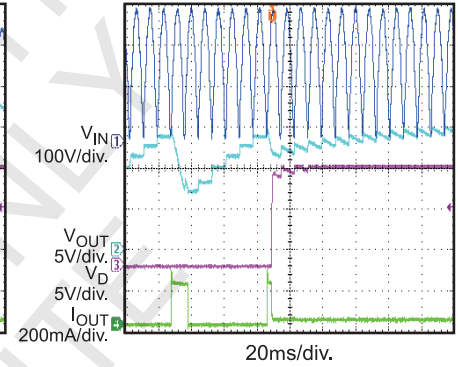

**VB Short to GND Protection Entry**

$V_{IN} = 115V_{AC}$

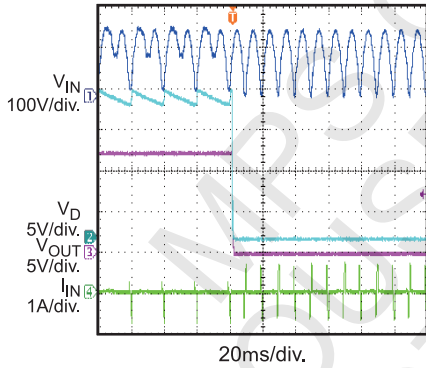

**VB Short to GND Protection Entry**

$V_{IN} = 230V_{AC}$

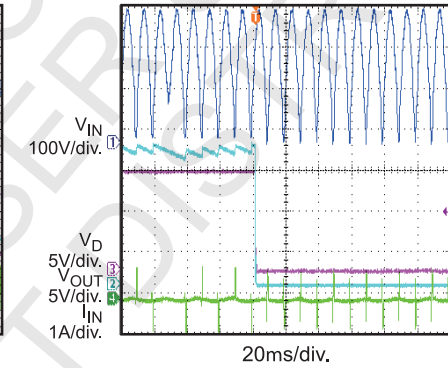

**VB Short to GND Protection Recovery**

$V_{IN} = 115V_{AC}$

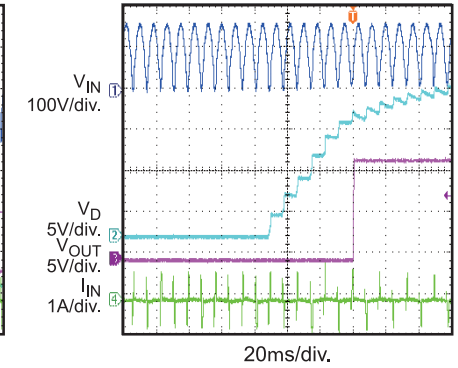

**VB Short to GND Protection Recovery**

$V_{IN} = 230V_{AC}$

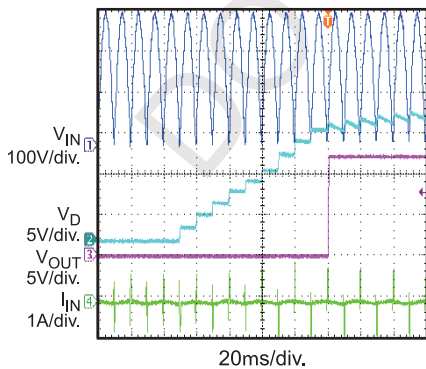

**Thermal Shutdown Protection Entry**

$V_{IN} = 115V_{AC}$

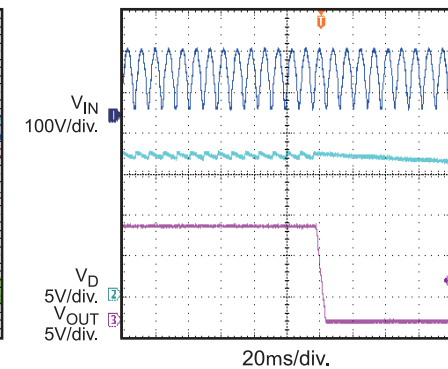

**Thermal Shutdown Protection Entry**

$V_{IN} = 230V_{AC}$

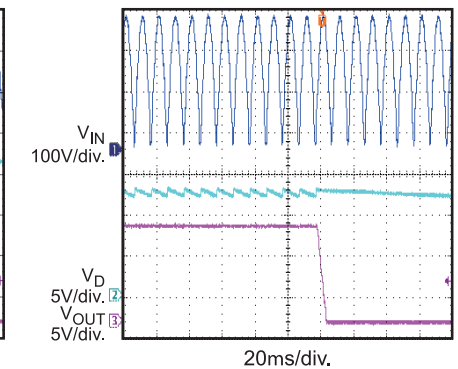



**EVB TEST RESULTS** *(continued)*

Performance waveforms are tested on the evaluation board.

$V_{OUT} = 12V$ ,  $I_{OUT} = 20mA$ ,  $T_A = 25^{\circ}C$ , unless otherwise noted.

**Thermal Shutdown Protection Recovery**

$V_{IN} = 115V_{AC}$

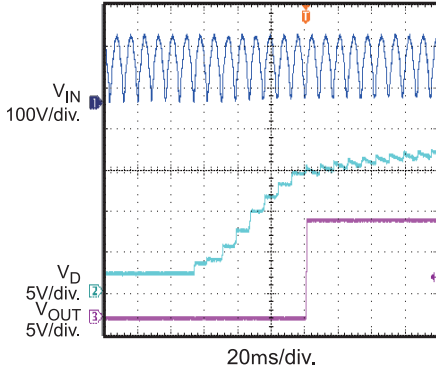

**Thermal Shutdown Protection Recovery**

$V_{IN} = 230V_{AC}$

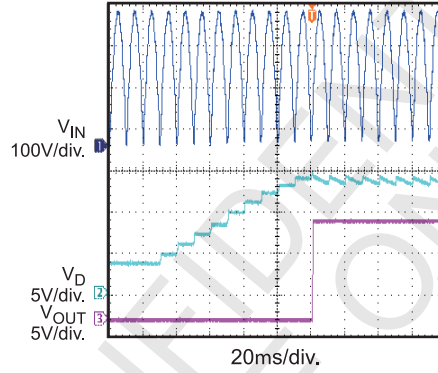

**EMI Performance**

115 L Line

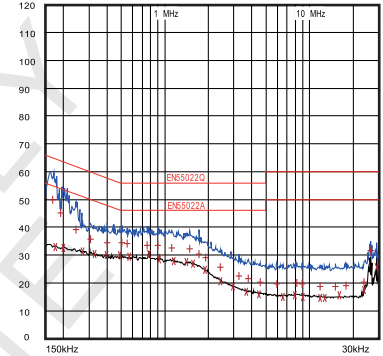

**EMI Performance**

115 N Line

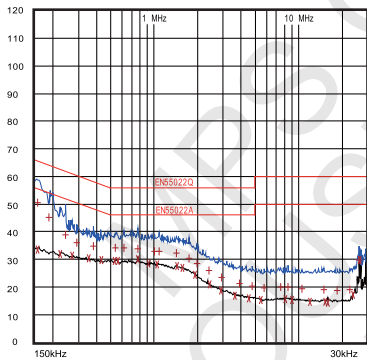

**EMI Performance**

230 L Line

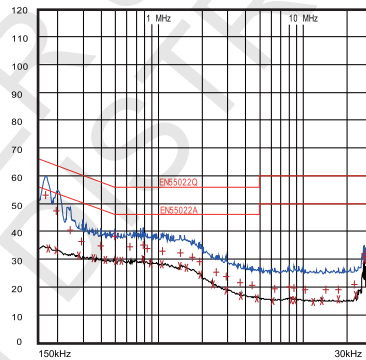

**EMI Performance**

230 N Line

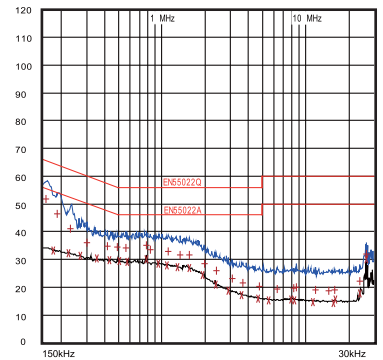

**PRINTED CIRCUIT BOARD LAYOUT**

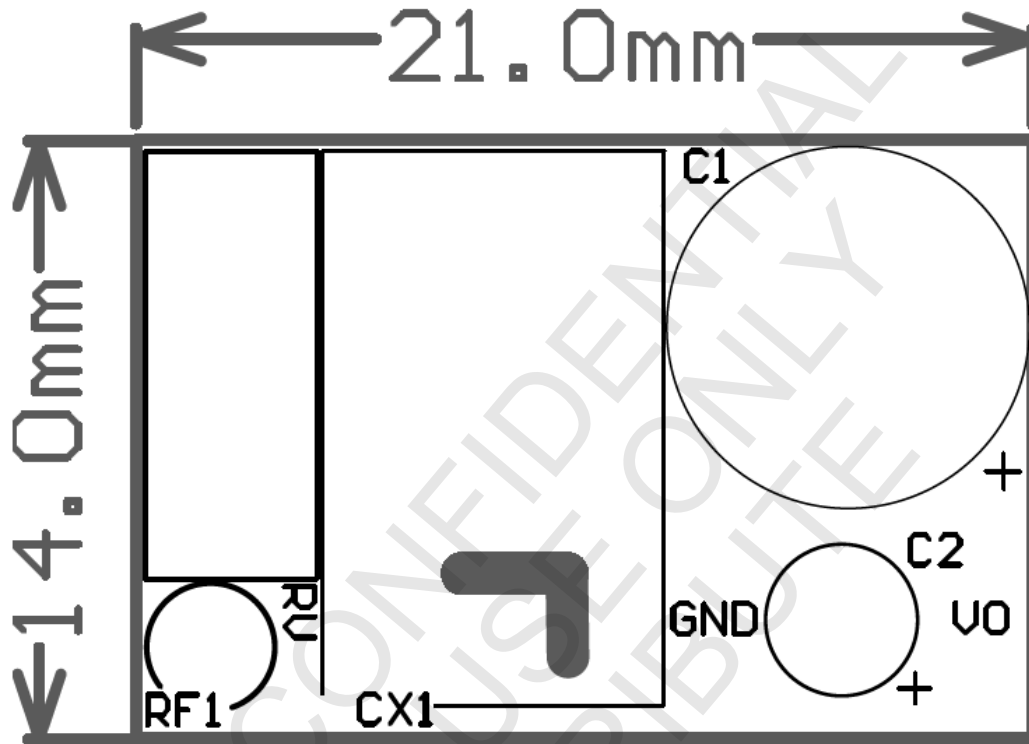

Figure 1 — Top Silk Layer

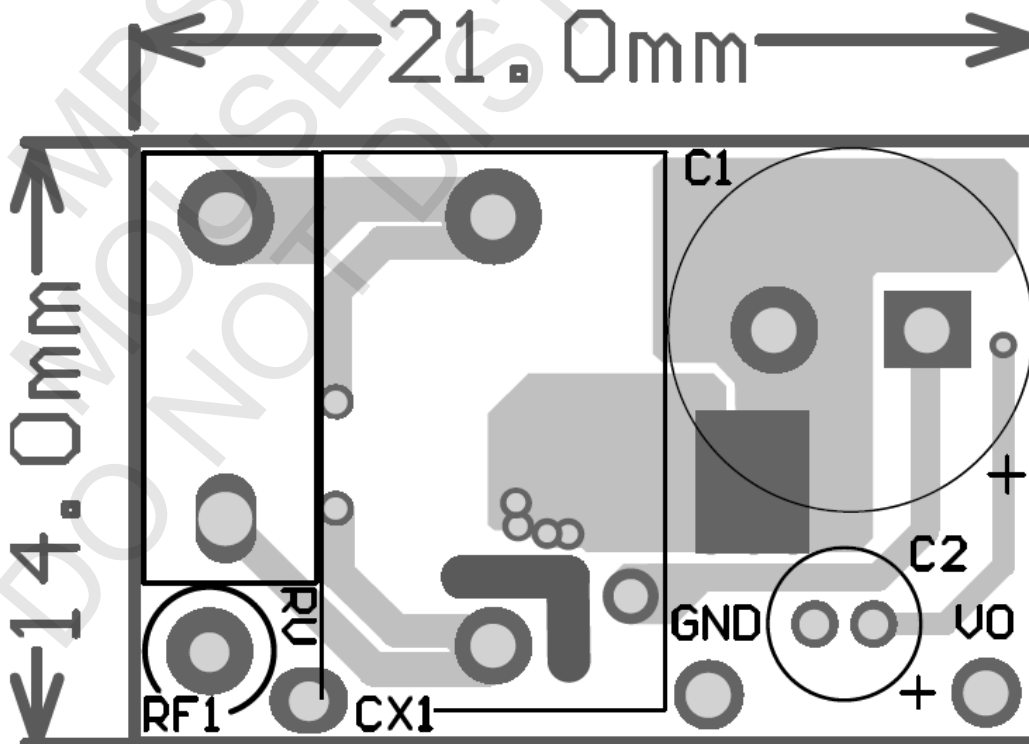

Figure 2 — Top Layer



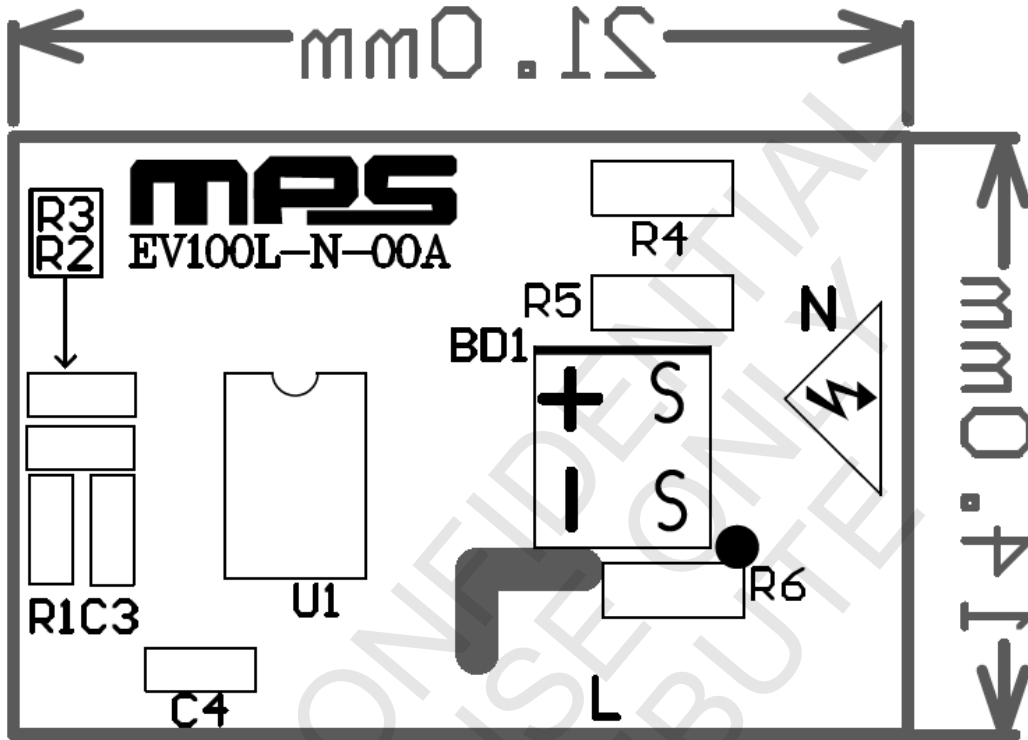

Figure 3 — Bottom Silk

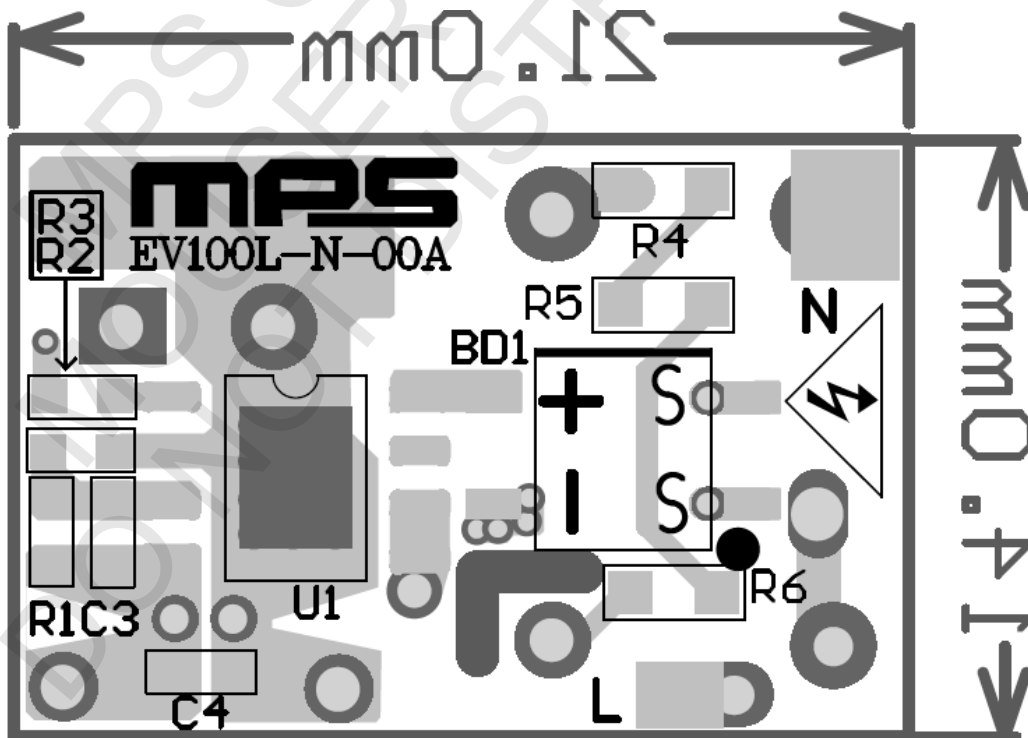

Figure 4 — Bottom Layer

## QUICK START GUIDE

1. Preset Power Supply to  $85V \leq V_{IN} \leq 265V$ .
2. Turn Power Supply off.
3. Connect the Line and Neutral terminals of the power supply output to L and N ports.
4. Connect Load to VO and GND ports.
5. Turn Power Supply on after making connections.

MPS CONFIDENTIAL  
MOUSER USE ONLY  
DO NOT DISTRIBUTE

**NOTICE:** The information in this document is subject to change without notice. Please contact MPS for current specifications. Users should warrant and guarantee that third party Intellectual Property rights are not infringed upon when integrating MPS products into any application. MPS will not assume any legal responsibility for any said applications.

# Mouser Electronics

Authorized Distributor

Click to View Pricing, Inventory, Delivery & Lifecycle Information:

[Monolithic Power Systems \(MPS\):](#)

[EV100L-N-00A](#)