

GENERAL ELECTRICAL & MECHANICAL SPECIFICATION

Switch Rating:	1A @ 115Vac
(Switching Resistive load):	
No Mains Isolation	1A @ 24Vdc
Current Carrying Capacity	5A non switching
Life:	>10,000 Cycles
Operating Temperature:	-20°C to +65 °C
Proof Voltage:	750 Vdc (Initial)
Insulation Resistance:	>999 MΩ at 500Vdc (Initial)
Contact Resistance:	<20 mΩ (Initial)
Lock Type:	5 Disc
Std. Qty. of Keys per Lock:	2 Mild Steel Ni Plated
Contact Material:	Brass CZ108 Ag Plated
Moulding Material:	Polyamide 6.6 G.F. V0 Rated
Lock Housing:	Zinc Alloy Bright Cr Plated



GENERAL FEATURES

- Made in UK.
- Miniature key-operated Lock switch.
- Single or Double pole
- Up to 200 key combinations – keys to differ.
- Common keys available – keys to pass.
- Keys are double entry (they can be inserted into the lock either way up).
- Occupies small panel area.
- Easily assembled through front of equipment panel.
- Rear projection less than 30mm from panel.
- Optional Extras :
 - Moulded bezel for parallel lock headed versions (SRL 02101).

SINGLE POLE LOCK SWITCH

Parallel Lock Head 90° Indexing

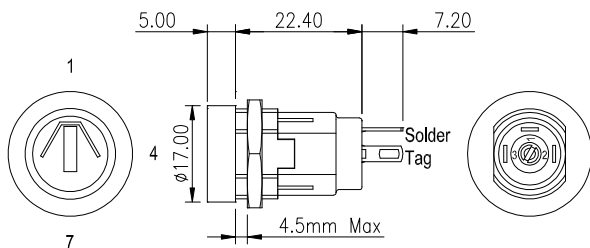

Key Withdrawal Positions

PANEL PIERCING DETAILS

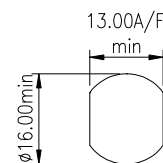

BASIC PART No.	TOTAL MOVEMENT	INDEXING	KEY WITHDRAWAL POSITIONS	SWITCH CONFIGURATION
SRL-5-A	90°	90°	1,4	
SRL-5-B	90°	90°	1 ONLY	
SRL-5-C	180°	90°	1,4,7	
SRL-5-N	180°	90°	1,4,7	

SINGLE POLE LOCK SWITCH

Tapered Lock Head 90° Indexing

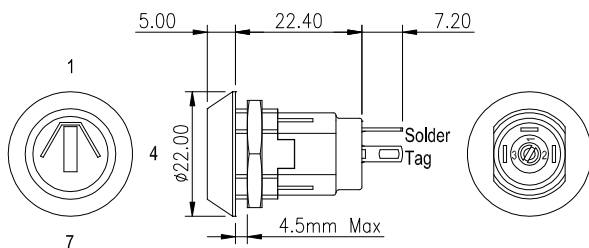

Key Withdrawal Positions

BASIC PART No.	TOTAL MOVEMENT	INDEXING	KEY WITHDRAWAL POSITIONS	SWITCH CONFIGURATION
SRL-5-D	90°	90°	1,4	
SRL-5-E	90°	90°	1 ONLY	
SRL-5-F	180°	90°	1,4,7	
SRL-5-P	180°	90°	1,4,7	

SRL LOCK SWITCHES

DOUBLE POLE LOCK SWITCH

Parallel Lock Head 60° Indexing

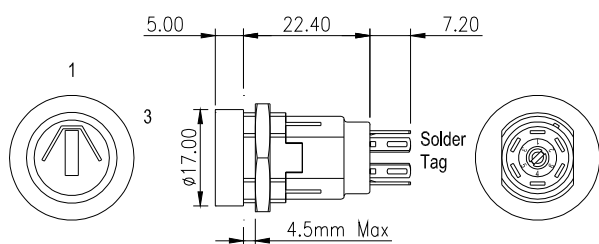

Key Withdrawal Positions

BASIC PART No.	TOTAL MOVEMENT	INDEXING	KEY WITHDRAWAL POSITIONS	SWITCH CONFIGURATION
SRL-5-J	60°	60°	1,3	1—2 3—5
SRL-5-K	60°	60°	1 ONLY	4—5 6—6

DOUBLE POLE LOCK SWITCH

Tapered Lock Head 60° Indexing

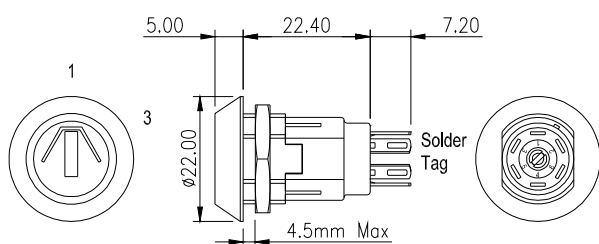

Key Withdrawal Positions

BASIC PART No.	TOTAL MOVEMENT	INDEXING	KEY WITHDRAWAL POSITIONS	SWITCH CONFIGURATION
SRL-5-L	60°	60°	1,3	1—2 3—5
SRL-5-M	60°	60°	1 ONLY	4—5 6—6

OPTIONAL EXTRAS

Moulded Bezel for Parallel Lock Headed Versions

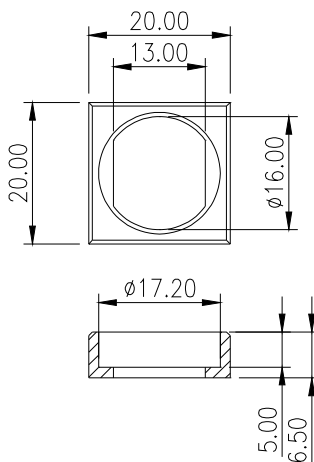

SUPPLIED LOOSE: ORDERING CODE SRL 02101

SRL LOCK SWITCH ORDER CODE

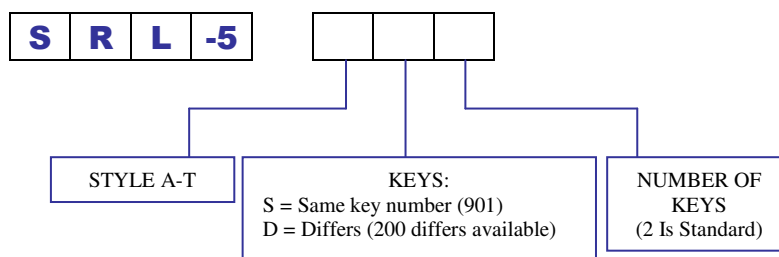

Mouser Electronics

Authorized Distributor

Click to View Pricing, Inventory, Delivery & Lifecycle Information:

[Lorlin:](#)

[SRL-5-E-S-2](#) [SRL-5-E-D-2](#) [SRL-5-D-S-2-850](#) [SRL-5-E-S-2-850](#) [SRL020](#) [SRL-5-D-S-2](#) [SRL-5-M-S-2](#) [SRL-5-L-M-S](#)
[SRL-5-F-S-2](#)