

Dimensions: mm (in.)

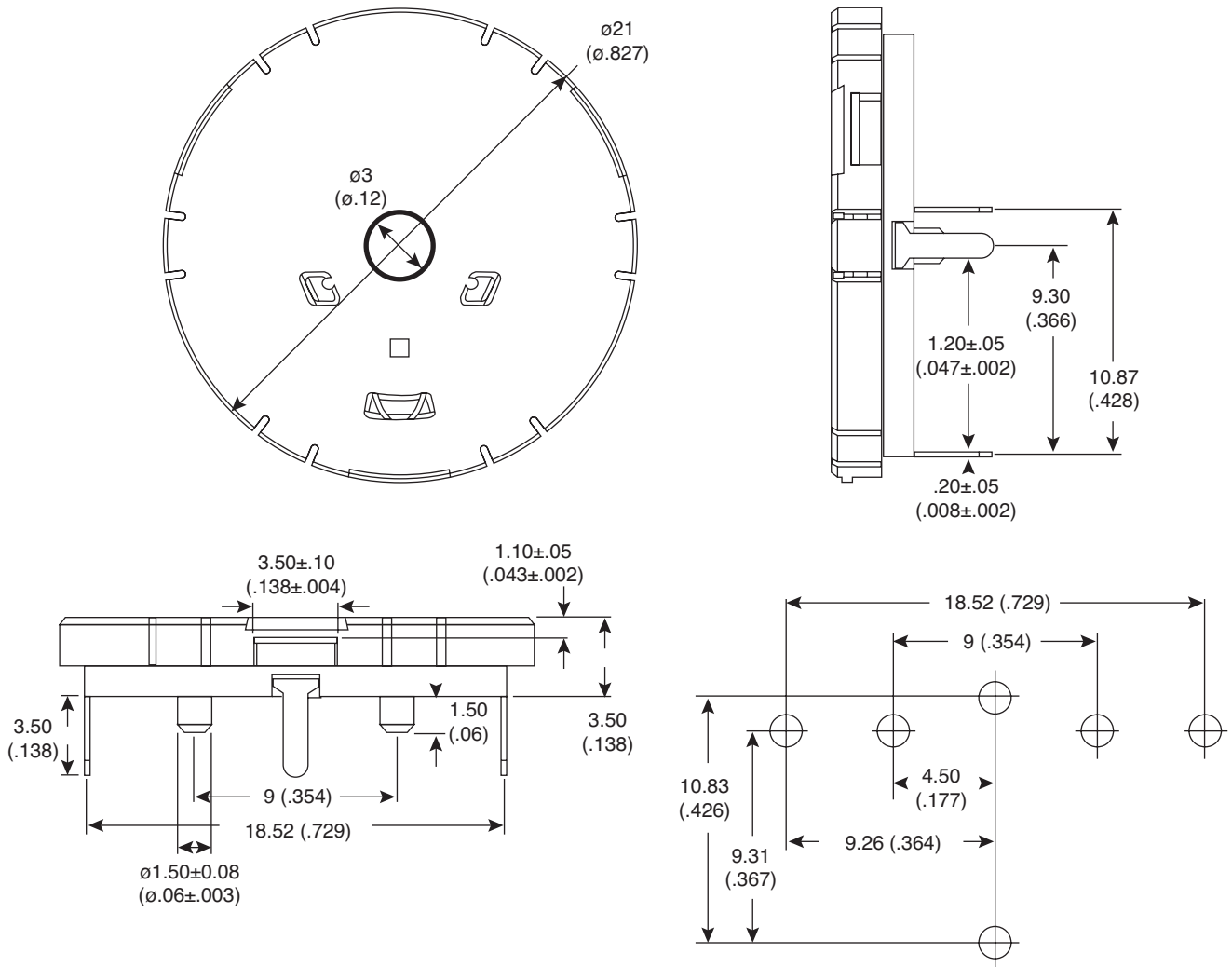

Electrical Specifications:

- Rating: 1mA/10VDC
- Insulation resistance: Min: 100 MΩ (at 100VDC for 1 minute)
- Initial Contact resistance: Max. 300mΩ
- Service Life: Rotation - Min. 200,000 operations (C.W. 100,000 & C.C.W. 100,000)
Push - Min. 1,000,000 operations
- Operating Frequency: Rotation - Max. 30 operations per minute
Push - Max. 120 operations per minute

Note:

- RoHS Compliant

Mechanical Specifications:

- Operating Force: Rotation Max 50gf-cm
Push 220±40gf
- Operating Temperature: 0°C ~40°C
- Storage Temperature: -40°C ~70°C

Soldering Process:

- Soldering Bath: Max. 260°C for 5 sec.
- Soldering By Hand: Max. 260°C for 5 seconds

Rotary Encoder with Center Push Switch

101-115-6110-EV



Mouser Electronics

Authorized Distributor

Click to View Pricing, Inventory, Delivery & Lifecycle Information:

[Mountain Switch:](#)

[101-115-6110-EV](#)