

Slide Potentiometers for Mixer Fader Controls

Low-profile Master Type (Super P Fader)

RS6011□P Series



Compact and good operational feel, suitable for mixing console faders.

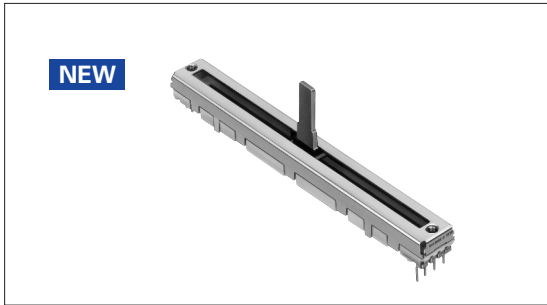

Typical Specifications

Items	Specifications
Total resistance tolerance	±20%
Maximum operating voltage	150V AC
Operating force	0.1 to 2.0N
Operating life	30,000cycles
Operating temperature range	-10°C to +60°C

Product Line

Number of resistor elements	Travel (mm)	Lever type	Length of lever (mm)	Total resistance (kΩ)	Resistance taper	Minimum packing unit (pcs.)	Products No.
Single-unit	60	6	15	10	1B	900	RS6011SP6003
				20	15A		RS6011SP6004
10				RS6011DP6002			
20				RS6011DP6003			
Dual-unit							

Packing Specifications

Tray

Number of packages (pcs.)		Export package measurements (mm)
1 case /Japan	1 case /export packing	
900	900	373 × 529 × 273

Dimensions

Unit:mm

Style	PC board mounting hole dimensions
	<p>The RS6011SP uses lug terminals for terminals 1' 2' 3'.</p>

Notes

1. Products other than those listed in above products are also available. Please contact us for details.
2. Please place purchase orders per minimum order unit N (integer).

Refer to P.457 for product varieties.
 Refer to P.457 for details of lever types.
 Refer to P.457, 458, 470 for resistance taper.

Product Varieties

In addition to the recommended products, the following specifications can also be accommodated.

Total Resistance Variety

Total resistance (kΩ)	10	20	50
-----------------------	----	----	----

Resistance Taper

Resistance taper	15A	1B	10A
------------------	-----	----	-----

Lever Types

Unit:mm

Configuration code	6 (Metal lever)
Dimensions	<p>t=1.2</p>
Length L ₁	15

Terminal Layout/Circuit Diagram (Viewed from Mounting Side)

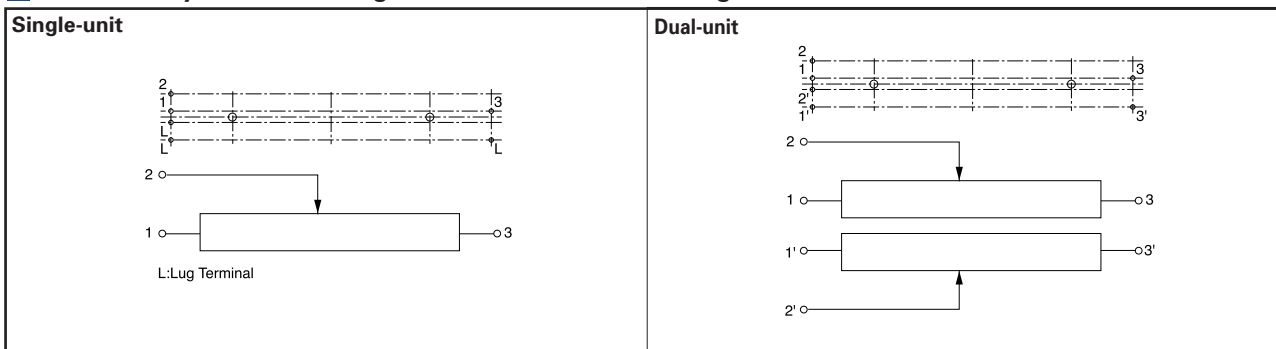

Corresponding Specifications

Dust cover	Available
------------	-----------

Notes

1. [Shaded] marked are specifications recommended by ALPS.
2. Products other than those listed in the above list are also available. Please contact us for details.
3. A variety of operational feels are available, so please inquire if you have a request.

Refer to P.458, 470 for resistance taper.

Rotary Potentiometers
Slide Potentiometers

General-use
Mixer

Orders Other Than Recommended Products

When ordering product varieties that are not listed in the Product Line, please specify by referring to the below example.

Sample Part Number

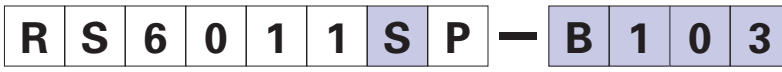

Number of resistor elements

Single-unit	S
Dual-unit	D

Resistance taper

Code	Resistance taper
A	15A
B	1B
D	10A

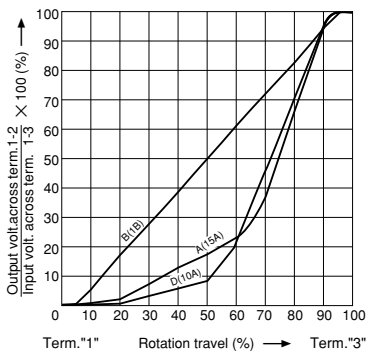

Total resistance







Code	Total resistance (kΩ)
103	10
203	20
503	50

Rotary Potentiometers
Slide Potentiometers

General-use

Mixer

List of Varieties

Item	Master type		Low-profile master type				Motor-driven master type					
	RS□□K□□		RS□□N1		RS□□N11S		RS6011□P		RSA0K1□V		RS□□N1□M	
Photo												
Outlined specifications	Travel (mm)		60 100				60		100		60 100	
	Number of resistor elements		Single-unit	Dual-unit	Single-unit	Dual-unit	Single-unit		Dual-unit	Single-unit		Dual-unit
Electrical Performance	Total resistance (kΩ)		10, 50, 100		RS□□N1 : 10, 50, 100, 250 RS□□N11S : 10, 50, 100, 250 RS6011□P : 10, 20, 50				RS□□N1□M : 10, 50, 100, 250 RSA0K1□V : 10			
	Resistance taper		15A, 1B		RS□□N1 : 15A, 1B, 10A RS□□N1□S : 15A, 1B, 10A RS6011□P : 15A, 1B, 10A				Single-unit : 1B Dual-unit : Servo 1B Audio 15A, 1B, 10A			
Mechanical Performance	Operating force		Standard : 0.1 to 0.6N		RS□□N1□ Single-unit : 0.05 to 0.8N Dual-unit : 0.05 to 0.9N RS6011□P 0.1 to 2.0N RS□□N11S 0.05 to 0.8N				RS□□N1□M 0.3 to 1.3N RSA0K1□V, Single-unit : 0.15 to 0.65N Dual-unit : 0.25 to 0.9N			
	Stopper strength		100N									
	Lever push-pull strength		100N		50N							
	Lever deviation (mm) ※Both Side		$\frac{2(2 \times L)}{25}$									
	Lever deviation		0.5mm max. (One side)									
Soldering	Manual soldering		350°C max. 3s max.									
	Dip soldering		—		260°C max. 5s max. RS□□N1□M (Lead type), RSA0K1□V : not available							
Environmental Performance	Cold		-30±2°C for 96h									
	Dry heat		70±2°C for 240h									
	Damp heat		40±2°C, 90 to 95%RH for 96h									
Page		445		449		453		456		459		

Rotary Potentiometers

Slide Potentiometers

General-use

Mixer

● Slide Volume Control Operations Cautions.....465, 466

Notes

- Attenuation is specified for residual resistance.
- "L" in the "Lever Wobble" column of the above table indicates the length of lever.
- Products other than those listed in the above list are also available. Please contact us for details.

Mouser Electronics

Authorized Distributor

Click to View Pricing, Inventory, Delivery & Lifecycle Information:

ALPS:

[RS6011SP6003](#)