

1.0A SURFACE MOUNT FAST RECOVERY RECTIFIER

Product Summary (@ T_A = +25°C)

V _{RRM} (V)	I _o (A)	V _F Max (V)	I _R Max (μA)
1,000	1	1.3	5

Features and Benefits

- Glass Passivated Die Construction
- Small Form Factor, Low Profile
- Fast Recovery Time for High Efficiency
- Surge Overload Rating to 30A Peak
- Low Reverse Leakage Current
- High Reverse Breakdown Voltage
- **Lead-Free Finish; RoHS Compliant (Notes 1 & 2)**
- **Halogen and Antimony Free. "Green" Device (Note 3)**

Description and Applications

The RS1MWF is a rectifier packaged in the small form factor, low profile SOD123F (Type B). Providing fast recovery time for high efficiency, low reverse leakage current and high surge current capability, this device is ideal for use in general rectification applications such as:

- Switching Mode Power Supplies
- DC-DC Converters
- AC-DC Adaptors/Chargers
- Mobile Devices

Mechanical Data

- Case: SOD123F (Type B)
- Case Material: Molded Plastic, "Green" Molding Compound. UL Flammability Classification Rating 94V-0
- Moisture Sensitivity: Level 1 per J-STD-020
- Terminals: Matte Tin Finish Annealed over Copper Leadframe. Solderable per MIL-STD-202, Method 208 (E3)
- Polarity: Cathode Band
- Weight: 0.018 grams (Approximate)

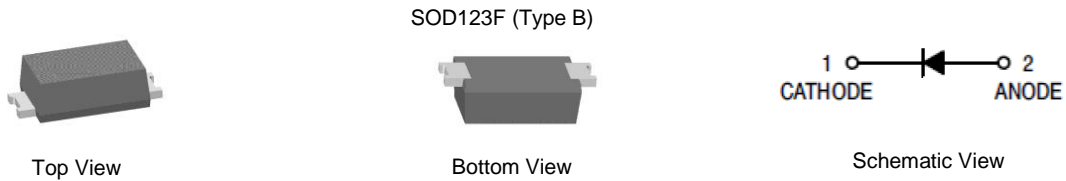

Ordering Information (Note 4)

Part Number	Compliance	Case	Packaging
RS1MWF-7	Commercial	SOD123F (Type B)	3,000/Tape & Reel

- Notes:
1. EU Directive 2002/95/EC (RoHS) & 2011/65/EU (RoHS 2) compliant. All applicable RoHS exemptions applied.
 2. See http://www.diodes.com/quality/lead_free.html for more information about Diodes Incorporated's definitions of Halogen- and Antimony-free, "Green" and Lead-free.
 3. Halogen- and Antimony-free "Green" products are defined as those which contain <900ppm bromine, <900ppm chlorine (<1500ppm total Br + Cl) and <1000ppm antimony compounds.
 4. For packaging details, go to our website at <http://www.diodes.com/products/packages.html>.

Marking Information

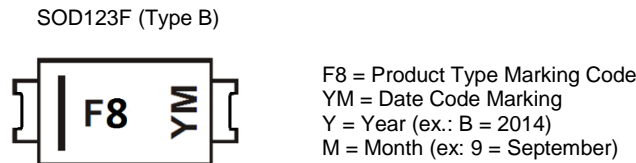

Date Code Key

Year	2014	2015	2016	2017	2018	2019	2020	2021
Code	B	C	D	E	F	G	H	I

Month	Jan	Feb	Mar	Apr	May	Jun	Jul	Aug	Sep	Oct	Nov	Dec
Code	1	2	3	4	5	6	7	8	9	O	N	D

Maximum Ratings (@T_A = +25°C, unless otherwise specified.)

Single phase, half wave, 60Hz, resistive or inductive load.
For capacitance load, derate current by 20%.

Characteristic	Symbol	Value	Unit
Peak Repetitive Reverse Voltage	V _{RRM}	1,000	V
Working Peak Reverse Voltage	V _{RWM}		
DC Blocking Voltage	V _{RM}		
RMS Reverse Voltage	V _{R(RMS)}	700	V
Average Rectified Output Current (@ T _T = +88°C)	I _O	1.0	A
Non-Repetitive Peak Forward Surge Current 8.3ms Single Half Sine-Wave Superimposed on Rated Load	I _{FSM}	30	A

Thermal Characteristics

Characteristic	Symbol	Value	Unit
Typical Thermal Resistance, Junction to Case (Note 5)	R _{θJC}	10	°C/W
Typical Thermal Resistance Junction to Ambient (Note 5)	R _{θJA}	65	°C/W
Operating and Storage Temperature Range	T _J , T _{STG}	-55 to +150	°C

Electrical Characteristics (@T_A = +25°C, unless otherwise specified.)

Characteristic	Symbol	Min	Typ	Max	Unit	Test Condition
Reverse Breakdown Voltage (Note 6)	V _{(BR)R}	1,000	—	—	V	I _R = 5μA
Forward Voltage Drop	V _F	—	1.0 0.9 1.1 1.0	1.3 1.2 — —	V	I _F = 1A, T _J = +25°C I _F = 1A, T _J = +125°C I _F = 2A, T _J = +25°C I _F = 2A, T _J = +125°C
Leakage Current (Note 6)	I _R	—	0.2 24	5.0 200	μA	V _R = 1,000V, T _J = +25°C V _R = 1,000V, T _J = +125°C
Reverse Recovery Time	t _{RR}	—	240	500	ns	I _F = 0.5A, I _R = 1.0A, I _{RR} = 0.25A
Total Capacitance	C _T	—	8	—	pF	V _R = 4.0V _{DC} , f = 1MHz

Notes: 5. Device mounted on FR-4 substrate, 1.0" x 1.0", 2oz, single-sided, PC boards with 0.2" x 0.25" copper pad.
6. Short duration pulse test used to minimize self-heating effect.

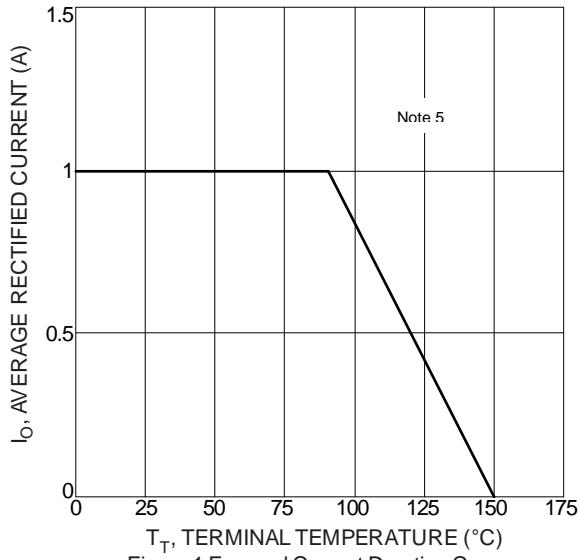

Figure 1 Forward Current Derating Curve

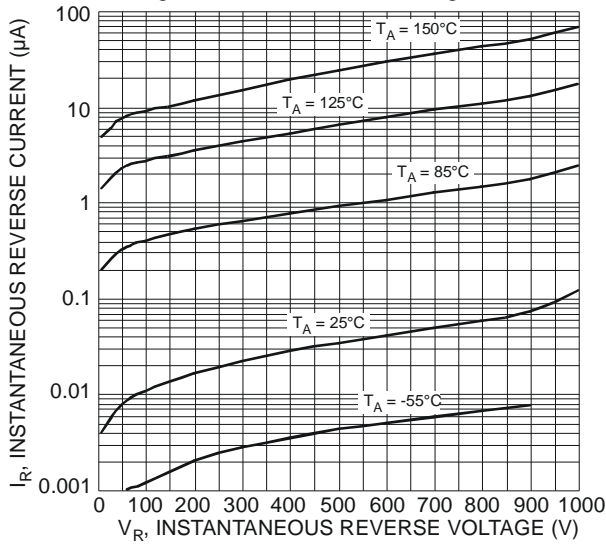

Figure 3 Typical Reverse Characteristics

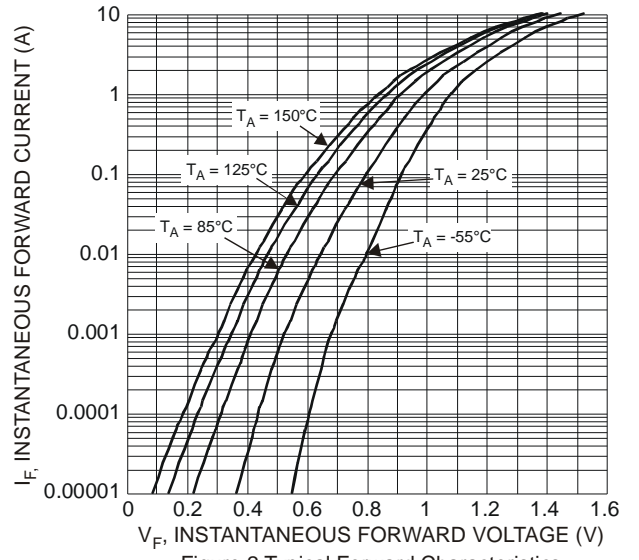

Figure 2 Typical Forward Characteristics

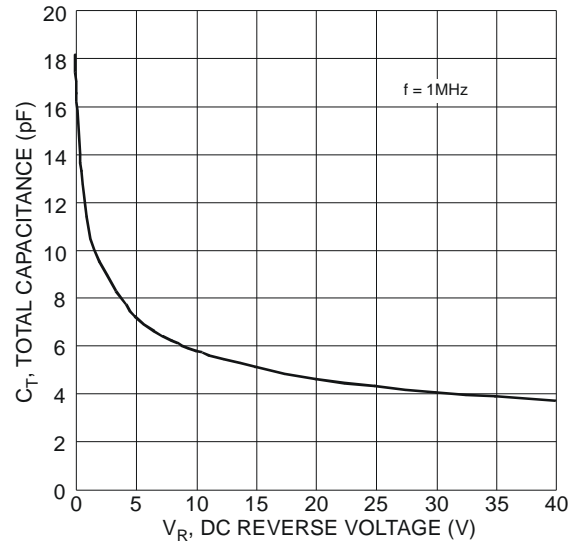
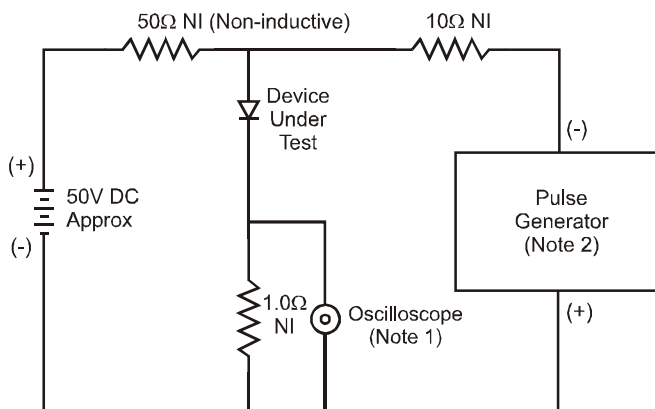
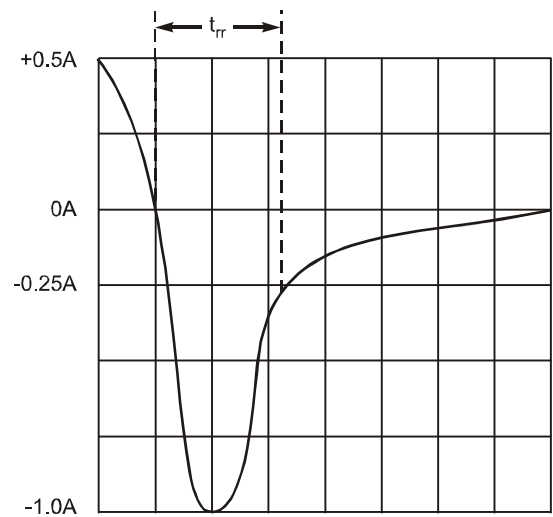

Figure 4 Total Capacitance vs. Reverse Voltage



- Notes:
1. Rise Time = 7.0ns max. Input Impedance = 1.0MΩ, 22pF.
 2. Rise Time = 10ns max. Input Impedance = 50Ω.



Set time base for 50/100 ns/cm

Figure 5 Reverse Recovery Time Characteristic and Test Circuit

Package Outline Dimensions

Please see <http://www.diodes.com/package-outlines.html> for the latest version.

SOD123F (Type B)

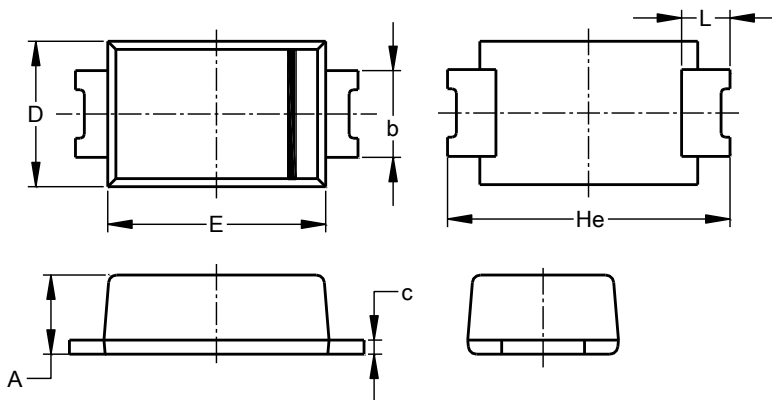

SOD123F (Type B)			
Dim	Min	Max	Typ
A	0.81	1.15	--
b	0.80	1.35	--
c	0.05	0.30	--
D	1.70	1.90	1.80
E	2.60	2.80	2.70
He	3.30	3.70	3.50
L	0.35	0.85	--
All Dimensions in mm			

Suggested Pad Layout

Please see <http://www.diodes.com/package-outlines.html> for the latest version.

SOD123F (Type B)

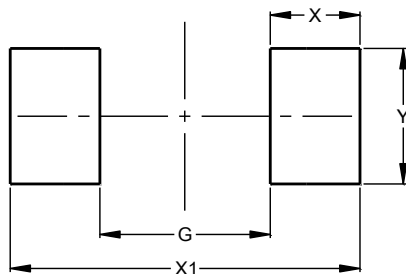

Dimensions	Value (in mm)
G	1.90
X	1.00
X1	3.90
Y	1.50

IMPORTANT NOTICE

DIODES INCORPORATED MAKES NO WARRANTY OF ANY KIND, EXPRESS OR IMPLIED, WITH REGARDS TO THIS DOCUMENT, INCLUDING, BUT NOT LIMITED TO, THE IMPLIED WARRANTIES OF MERCHANTABILITY AND FITNESS FOR A PARTICULAR PURPOSE (AND THEIR EQUIVALENTS UNDER THE LAWS OF ANY JURISDICTION).

Diodes Incorporated and its subsidiaries reserve the right to make modifications, enhancements, improvements, corrections or other changes without further notice to this document and any product described herein. Diodes Incorporated does not assume any liability arising out of the application or use of this document or any product described herein; neither does Diodes Incorporated convey any license under its patent or trademark rights, nor the rights of others. Any Customer or user of this document or products described herein in such applications shall assume all risks of such use and will agree to hold Diodes Incorporated and all the companies whose products are represented on Diodes Incorporated website, harmless against all damages.

Diodes Incorporated does not warrant or accept any liability whatsoever in respect of any products purchased through unauthorized sales channel. Should Customers purchase or use Diodes Incorporated products for any unintended or unauthorized application, Customers shall indemnify and hold Diodes Incorporated and its representatives harmless against all claims, damages, expenses, and attorney fees arising out of, directly or indirectly, any claim of personal injury or death associated with such unintended or unauthorized application.

Products described herein may be covered by one or more United States, international or foreign patents pending. Product names and markings noted herein may also be covered by one or more United States, international or foreign trademarks.

This document is written in English but may be translated into multiple languages for reference. Only the English version of this document is the final and determinative format released by Diodes Incorporated.

LIFE SUPPORT

Diodes Incorporated products are specifically not authorized for use as critical components in life support devices or systems without the express written approval of the Chief Executive Officer of Diodes Incorporated. As used herein:

A. Life support devices or systems are devices or systems which:

1. are intended to implant into the body, or
2. support or sustain life and whose failure to perform when properly used in accordance with instructions for use provided in the labeling can be reasonably expected to result in significant injury to the user.

B. A critical component is any component in a life support device or system whose failure to perform can be reasonably expected to cause the failure of the life support device or to affect its safety or effectiveness.

Customers represent that they have all necessary expertise in the safety and regulatory ramifications of their life support devices or systems, and acknowledge and agree that they are solely responsible for all legal, regulatory and safety-related requirements concerning their products and any use of Diodes Incorporated products in such safety-critical, life support devices or systems, notwithstanding any devices- or systems-related information or support that may be provided by Diodes Incorporated. Further, Customers must fully indemnify Diodes Incorporated and its representatives against any damages arising out of the use of Diodes Incorporated products in such safety-critical, life support devices or systems.

Copyright © 2016, Diodes Incorporated

www.diodes.com

Mouser Electronics

Authorized Distributor

Click to View Pricing, Inventory, Delivery & Lifecycle Information:

[Diodes Incorporated:](#)

[RS1MWF-7](#)