

**20V PNP SILICON LOW SATURATION TRANSISTOR IN SOT23**

**Features and Benefits**

- $BV_{CEO} > -20V$
- $I_C = -1A$  Continuous Collector Current
- $I_{CM} = -2A$  Peak Pulse Current
- Low Saturation Voltage  $V_{CE(sat)} < -320mV @ -1A$
- $h_{FE}$  characterised up to  $-1.5A$  for high current gain hold-up
- 500mW power dissipation
- Complementary part number FMMTL618
- **Lead Free, RoHS Compliant (Note 1)**
- **Halogen and Antimony Free "Green" Device (Note 2)**
- **Qualified to AEC-Q101 Standards for High Reliability**

**Mechanical Data**

- Case: SOT-23
- UL Flammability Rating 94V-0
- Case material: molded Plastic.
- Moisture Sensitivity: Level 1 per J-STD-020D
- Terminals: Matte Tin Finish annealed over Copper plated Alloy 42 leadframe. Solderable per MIL-STD-202, Method 208
- Weight: 0.008 grams (Approximate)

**Applications**

- MOSFET Gate Driving
- DC-DC Converters
- Charging circuit
- Power switches

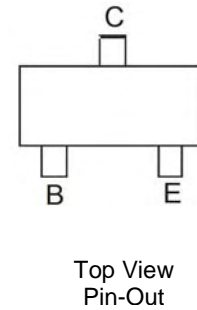
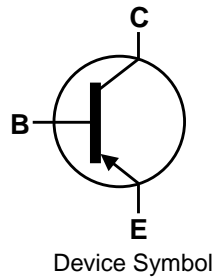

**Ordering Information** (Note 3)

Product	Marking	Reel size (inches)	Tape width (mm)	Quantity per reel
FMMTL718TA	L78	7	8	3,000

- Notes:
1. No purposefully added lead.
  2. Diodes Inc.'s "Green" Policy can be found on our website at <http://www.diodes.com>
  3. For Packaging Details, go to our website at <http://www.diodes.com>.

**Marking Information**

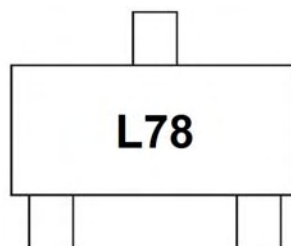

L78 = Product Type Marking Code

**Maximum Ratings** @ $T_A = 25^\circ\text{C}$  unless otherwise specified

Characteristic	Symbol	Value	Unit
Collector-Base Voltage	$V_{CBO}$	-20	V
Collector-Emitter Voltage	$V_{CEO}$	-20	V
Emitter-Base Voltage	$V_{EBO}$	-5	V
Continuous Collector Current	$I_C$	-1	A
Peak Pulse Current	$I_{CM}$	-2	A
Base Current	$I_B$	-200	mA

**Thermal Characteristics** @ $T_A = 25^\circ\text{C}$  unless otherwise specified

Characteristic	Symbol	Value	Unit
Power Dissipation (Note 4)	$P_D$	500	mW
Thermal Resistance, Junction to Ambient (Note 4)	$R_{\theta JA}$	250	$^\circ\text{C/W}$
Thermal Resistance, Junction to Lead (Note 5)	$R_{\theta JL}$	197	$^\circ\text{C/W}$
Operating and Storage Temperature Range	$T_J, T_{STG}$	-55 to +150	$^\circ\text{C}$

- Notes:
4. For a device surface mounted on 15mm X 15mm FR4 PCB with high coverage of single sided 1 oz copper, in still air conditions; the device is measured when operating in a steady-state condition.
  5. Thermal resistance from junction to solder-point (at the end of the collector lead).

**Electrical Characteristics** @ $T_A = 25^\circ\text{C}$  unless otherwise specified

Characteristic	Symbol	Min	Typ	Max	Unit	Test Condition
Collector-Base Breakdown Voltage	$BV_{CBO}$	-20	-65		V	$I_C = -100 \mu\text{A}$
Collector-Emitter Breakdown Voltage (Note 6)	$BV_{CEO}$	-20	-55		V	$I_C = -10 \text{ mA}$
Emitter-Base Breakdown Voltage	$BV_{EBO}$	-5	-8.8		V	$I_E = -100 \mu\text{A}$
Collector Cutoff Current	$I_{CBO}$			-10	nA	$V_{CB} = -15\text{V}$
Emitter Cutoff Current	$I_{EBO}$			-10	nA	$V_{EB} = -4\text{V}$
Collector Emitter Cutoff Current	$I_{CES}$			-10	nA	$V_{CE} = -15\text{V}$
Static Forward Current Transfer Ratio (Note 6)	$h_{FE}$	300 300 200 120 50	500 450 320 200 80			$I_C = -10\text{mA}, V_{CE} = -2\text{V}$ $I_C = -100\text{mA}, V_{CE} = -2\text{V}$ $I_C = -0.5\text{A}, V_{CE} = -2\text{V}$ $I_C = -1\text{A}, V_{CE} = -2\text{V}$ $I_C = -1.5\text{A}, V_{CE} = -2\text{V}$
Collector-Emitter Saturation Voltage (Note 6)	$V_{CE(sat)}$		-33 -130 -230 -315	-50 -180 -320 -450	mV mV mV mV	$I_C = -100\text{mA}, I_B = -10\text{mA}$ $I_C = -500\text{mA}, I_B = -20\text{mA}$ $I_C = -1\text{A}, I_B = -50\text{mA}$ $I_C = -1.5\text{A}, I_B = -100\text{mA}$
Base-Emitter Turn-On Voltage (Note 6)	$V_{BE(on)}$		-0.85	-1.0	V	$I_C = -1.25\text{A}, V_{CE} = -2\text{V}$
Base-Emitter Saturation Voltage (Note 6)	$V_{BE(sat)}$		-0.95	-1.1	V	$I_C = -1.25\text{A}, I_B = -100\text{mA}$
Equivalent On-Resistance	$R_{CE(sat)}$		210		m $\Omega$	$I_C = -1.5\text{A}$
Output Capacitance	$C_{obo}$		9	12	pF	$V_{CB} = -10\text{V}, f = 1\text{MHz}$
Transition Frequency	$f_T$		265		MHz	$V_{CE} = -10\text{V}, I_C = -50\text{mA}, f = 100\text{MHz}$
Turn-On Time	$t_{on}$		108		ns	$V_{CC} = -10\text{V}, I_C = -1\text{A}$
Turn-Off Time	$t_{off}$		121		ns	$I_{B1} = I_{B2} = -10\text{mA}$

- Note: 6. Measured under pulsed conditions. Pulse width  $\leq 300 \mu\text{s}$ . Duty cycle  $\leq 2\%$

**Typical Electrical Characteristics**

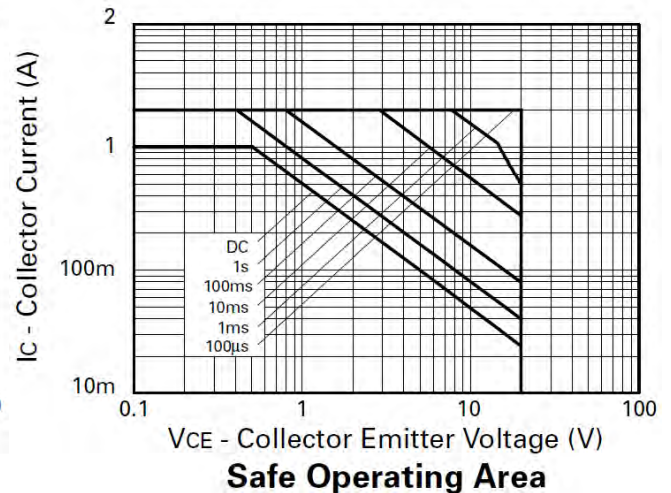
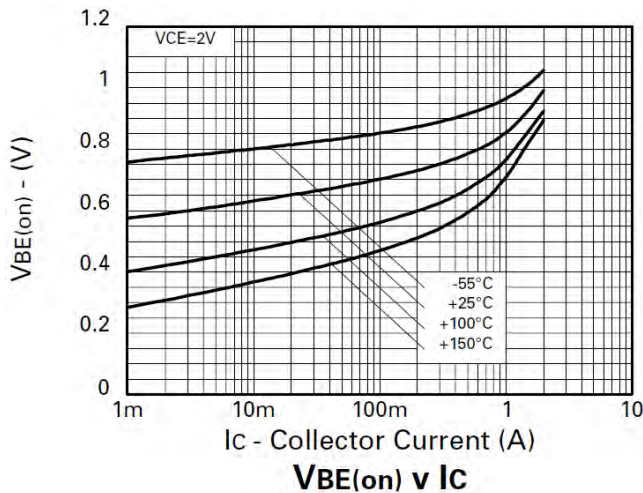
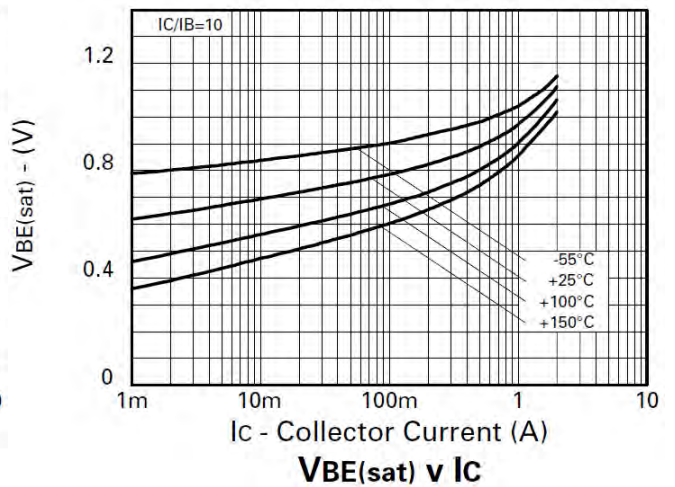
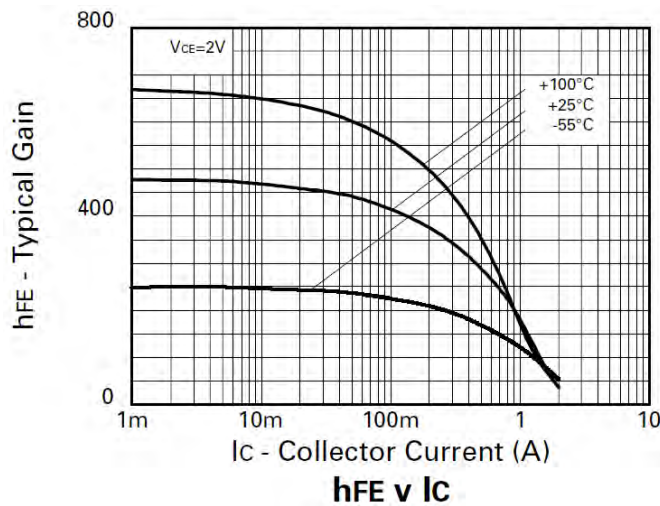
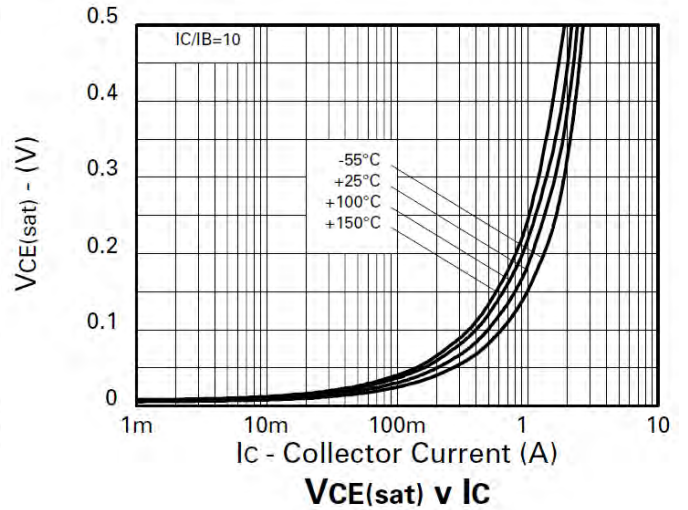
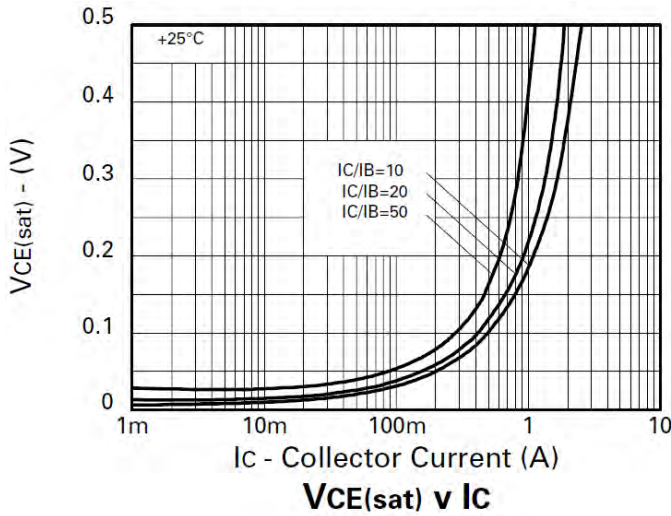

**Package Outline Dimensions**

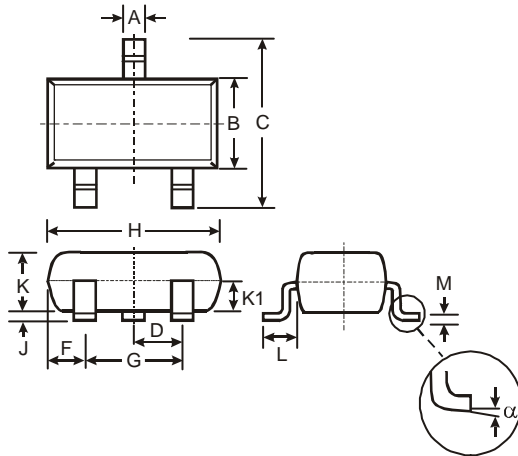

SOT23			
Dim	Min	Max	Typ
A	0.37	0.51	0.40
B	1.20	1.40	1.30
C	2.30	2.50	2.40
D	0.89	1.03	0.915
F	0.45	0.60	0.535
G	1.78	2.05	1.83
H	2.80	3.00	2.90
J	0.013	0.10	0.05
K	0.903	1.10	1.00
K1	-	-	0.400
L	0.45	0.61	0.55
M	0.085	0.18	0.11
α	0°	8°	-
All Dimensions in mm			

**Suggested Pad Layout**

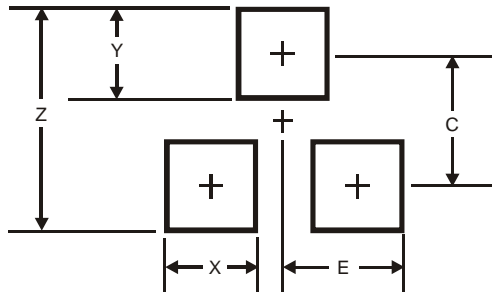

Dimensions	Value (in mm)
Z	2.9
X	0.8
Y	0.9
C	2.0
E	1.35

**IMPORTANT NOTICE**

DIODES INCORPORATED MAKES NO WARRANTY OF ANY KIND, EXPRESS OR IMPLIED, WITH REGARDS TO THIS DOCUMENT, INCLUDING, BUT NOT LIMITED TO, THE IMPLIED WARRANTIES OF MERCHANTABILITY AND FITNESS FOR A PARTICULAR PURPOSE (AND THEIR EQUIVALENTS UNDER THE LAWS OF ANY JURISDICTION).

Diodes Incorporated and its subsidiaries reserve the right to make modifications, enhancements, improvements, corrections or other changes without further notice to this document and any product described herein. Diodes Incorporated does not assume any liability arising out of the application or use of this document or any product described herein; neither does Diodes Incorporated convey any license under its patent or trademark rights, nor the rights of others. Any Customer or user of this document or products described herein in such applications shall assume all risks of such use and will agree to hold Diodes Incorporated and all the companies whose products are represented on Diodes Incorporated website, harmless against all damages.

Diodes Incorporated does not warrant or accept any liability whatsoever in respect of any products purchased through unauthorized sales channel. Should Customers purchase or use Diodes Incorporated products for any unintended or unauthorized application, Customers shall indemnify and hold Diodes Incorporated and its representatives harmless against all claims, damages, expenses, and attorney fees arising out of, directly or indirectly, any claim of personal injury or death associated with such unintended or unauthorized application.

Products described herein may be covered by one or more United States, international or foreign patents pending. Product names and markings noted herein may also be covered by one or more United States, international or foreign trademarks.

**LIFE SUPPORT**

Diodes Incorporated products are specifically not authorized for use as critical components in life support devices or systems without the express written approval of the Chief Executive Officer of Diodes Incorporated. As used herein:

- A. Life support devices or systems are devices or systems which:
1. are intended to implant into the body, or
  2. support or sustain life and whose failure to perform when properly used in accordance with instructions for use provided in the labeling can be reasonably expected to result in significant injury to the user.
- B. A critical component is any component in a life support device or system whose failure to perform can be reasonably expected to cause the failure of the life support device or to affect its safety or effectiveness.

Customers represent that they have all necessary expertise in the safety and regulatory ramifications of their life support devices or systems, and acknowledge and agree that they are solely responsible for all legal, regulatory and safety-related requirements concerning their products and any use of Diodes Incorporated products in such safety-critical, life support devices or systems, notwithstanding any devices- or systems-related information or support that may be provided by Diodes Incorporated. Further, Customers must fully indemnify Diodes Incorporated and its representatives against any damages arising out of the use of Diodes Incorporated products in such safety-critical, life support devices or systems.

Copyright © 2011, Diodes Incorporated

[www.diodes.com](http://www.diodes.com)

# Mouser Electronics

Authorized Distributor

Click to View Pricing, Inventory, Delivery & Lifecycle Information:

[Diodes Incorporated:](#)

[FMRTL718TA](#)