

Rocker Switch

Single and Double Pole

RR Series



Features

- Lighted and non-lighted versions
- Minimum 100,000 operations mechanical life
- RoHS Compliant

Standard Parts¹

North America		North America and Europe		Europe	
RRA22H3BBALN	RRA22H3BBRLN	RRA22H3BBBNN	RRA32H3FBBNN	RRA22H3FBBNN	RRA32H3BBRLN
RRA22H3BBGLN	RRA22H3FBRNN			RRA32H3BBBNN	RRA32H3BBGEN
RRA22H3BBRHN	RRA32H3BBRLN			RRA32H3BBREN	RRA32H3BBGLN

¹The part number configuration matrix below provides details to the part numbers above. For configurable part numbers that are not listed above, not listed in your region, or for custom part numbers, contact the factory or your distributor.

Part Number Breakdown

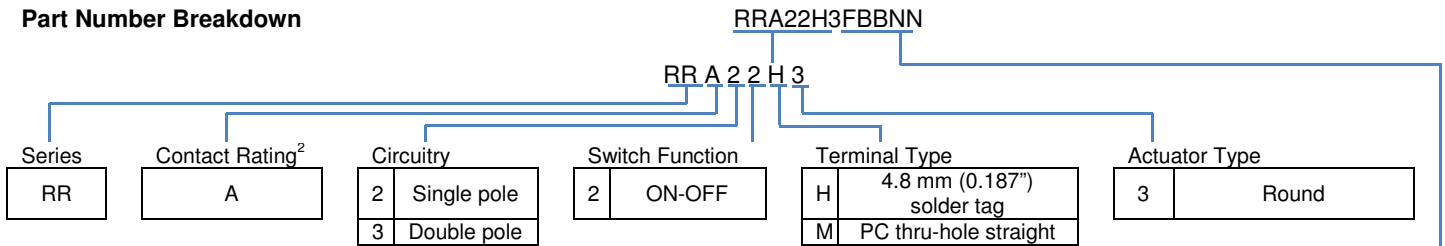

²See Electrical Specifications section

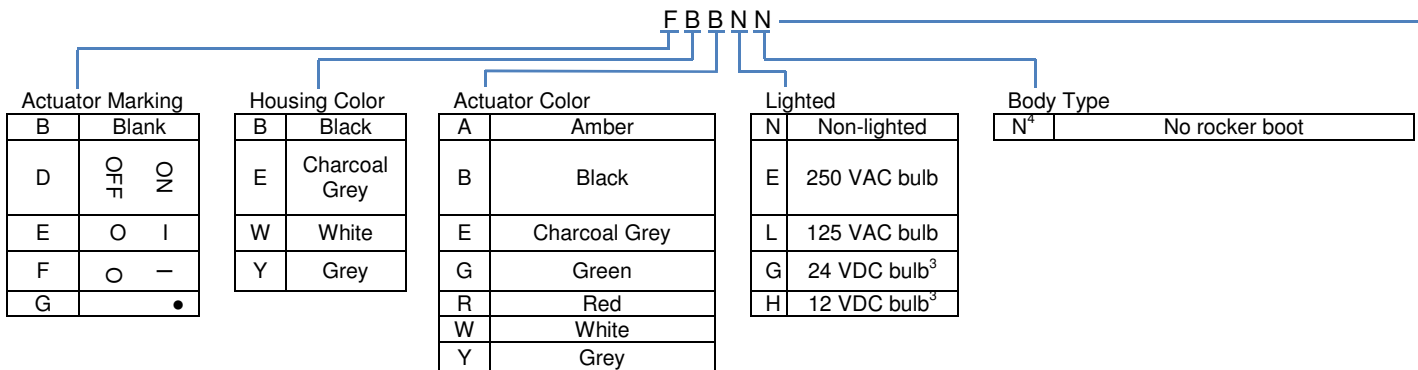

³Switches have no agency DC ratings

⁴A splash-proof boot can be ordered separately as part number 00150751



Electrical Specifications

Inrush Rating	24 A		
Dielectric Strength	1000 VAC for 1 minute		
Insulation Resistance	100 MΩ min at 500 VDC		
Initial Contact Resistance	0.020 Ω max		
Electrical Ratings			
Switch Function	EN61058-1	UL Gen Purpose 1054	UL HP
2	10 (4) A 250 V~ T125/55	10 A 125 VAC / 8 A 250 VAC	¼ HP 125 / 250 VAC
Electrical Life at Rated Load Minimum Operations	VDE 10,000	UL 6,000	
UL File No: E23301			

Material and Environmental Specifications

Actuator	Nylon 66 94V-2
Base	Nylon 66 94V-2
Spring	Steel Wire
Contacts	Silver Alloy
Movable Arm	Copper Alloy
Terminals	Tin-Plated Copper Alloy
Operating Temperature Range	-20 °C to +65 °C (-4 °F to +149 °F)

Circuitry and Switch Functions

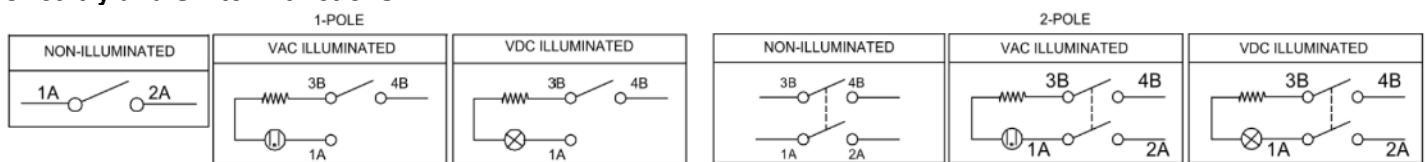

Dimensions mm (inches)

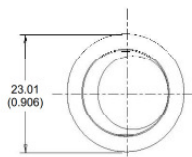
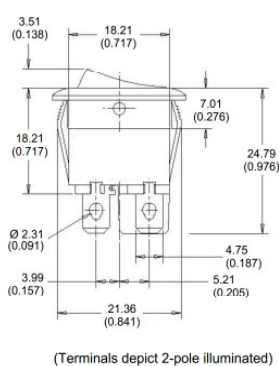

NOTE: ALL TOLERANCES ±0.3 (0.012) UNLESS OTHERWISE SPECIFIED

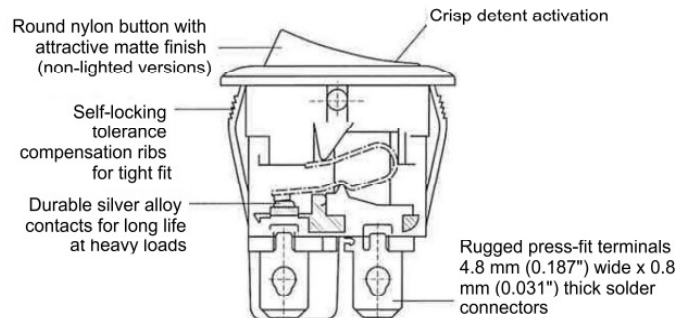

Recommended Panel Cut-Out Dimensions
Panel Thickness 1.0 to 2.0 (0.039 to 0.078)

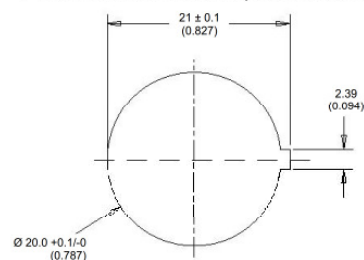

Mouser Electronics

Authorized Distributor

Click to View Pricing, Inventory, Delivery & Lifecycle Information:

ZF Electronics:

[RRA22H3BBGLN](#) [RRA22H3DBBNN](#) [RRA22H3BBRHN](#) [RRA32H3BBRLN](#) [RRA22H3BBALN](#) [RRA22H3BBRLN](#)
[RRA22H3BBBNN](#) [RRA22H3FBRNN](#) [RRA32H3FBBNN](#) [RRA22H3BWWNN](#) [RRA22H3BBRGN](#) [RRA22H3BWRNN](#)
[RRA22H3BBGHN](#)