

# YEV09T10

## 10 A DC-DC POL Converter 4.5 - 13.8 V Input; 0.59 - 5.1 V Output



### Key Features

- RoHS lead free and lead-solder-exempt products are available
- Wide operating temperature range: 0 to 70 °C;
- optional to a range of -40 to 85 °C
- High efficiency synchronous buck topology
- Low noise fixed frequency operation
- Wide input voltage range: 4.5 V–13.8 V
- High continuous output current: 10 A
- Programmable output voltage range: 0.59 V–5.1 V
- Overcurrent, and output overvoltage protections with automatic restart
- Enable input
- Start up into prebiased load
- No minimum load requirements
- High MTBF of 67 million hours
- Industry standard size through-hole single-in-line package and pinout: 0.41 x 0.65 x 0.40 inches (10.4 x 16.51 x 10.16 mm)
- UL94 V-0 flammability rating
- Approved to the latest edition and amendment of ITE Safety standards, UL/CSA 60950-1 and IEC60950-1

Bel Power Solutions point-of-load converters are recommended for use with regulated bus converters in an Intermediate Bus Architecture (IBA). The YEV09T10, non-isolated DC-DC point of load (POL) converter, delivers up to 10A of output current in an industry-standard single-in-line (SIP) through-hole package. The YEV09T10 POL converter is an ideal choice for Intermediate Bus Architectures where point of load conversion is a requirement.

Operating from a 4.5-13.8 V input the POL converter provides an extremely tightly regulated programmable output voltage of 0.59 V to 5.1 V. The POL converter offers exceptional thermal performance, even in high temperature environments with minimal airflow. This performance is accomplished through the use of advanced circuit solutions, packaging and processing techniques. The resulting design possesses ultra-high efficiency, excellent thermal management, and a slim body profile that minimizes impedance to system airflow, thus enhancing cooling for both upstream and downstream devices. The use of automation for assembly, coupled with advanced power electronics and thermal design, results in a product with extremely high reliability.

### Applications

- Low voltage, high density systems with Intermediate Bus Architectures (IBA)
- Point-of-load regulators for high performance DSP, FPGA, ASIC, and microprocessors
- Desktops, servers, and portable computing
- Broadband, networking, optical, and communications systems

### Benefits

- One part that covers many applications
- Reduces board space, system cost and complexity, and time to market

**North America**  
+1 866 513 2839

**Asia-Pacific**  
+86 755 29885888

**Europe, Middle East**  
+353 61 225 977

tech.support@psbel.com  
[belpowersolutions.com](http://belpowersolutions.com)

# YEV09T10

## 1. ABSOLUTE MAXIMUM RATINGS

Stresses in excess of the absolute maximum ratings may cause performance degradation, adversely affect long-term reliability, and cause permanent damage to the converter.

PARAMETER	CONDITIONS / DESCRIPTION	MIN	MAX	UNITS
Input Voltage	Continuous	-0.3	15	VDC
Ambient Temperature Range	Operating	0	70	°C
Storage Temperature (Ts)		-55	125	°C
Case Temperature (Tc)	Measured on the inductor L100		125	°C

## 2. ENVIRONMENTAL AND MECHANICAL SPECIFICATIONS

PARAMETER	CONDITIONS / DESCRIPTION	MIN	NOM	MAX	UNITS
Weight				2.5	grams
MTBF	Calculated Per Telcordia Technologies SR-332, Method I Case 1, 50% electrical stress, 40°C ambient temperature	67			MHrs
Lead Plating	YEV09T10-x and YEV09T10-xG			100% Matte Tin	

## 3. ELECTRICAL SPECIFICATIONS

Specifications apply at the input voltage from 4.5V to 13.8V, output load from 0 to 10A, output voltage from 0.59V to 5.1V, 22µF external output capacitor, and ambient temperature from 0°C to 70°C unless otherwise noted.

### 3.1 INPUT SPECIFICATIONS

PARAMETER	CONDITIONS / DESCRIPTION	MIN	NOM	MAX	UNITS
Input voltage (V <sub>IN</sub> )	0.59 V ≤ V <sub>OUT</sub> ≤ 3.63 V	4.5	12	13.8	VDC
	3.64 V ≤ V <sub>OUT</sub> ≤ 5.1 V	6.5	12	13.8	
Undervoltage Lockout Turn On Threshold	Input Voltage Ramping Up	4.1	4.3	4.5	VDC
Undervoltage Lockout Turn Off Threshold	Input Voltage Ramping Down	3.9	4.1	4.3	VDC
Standby Input Current	V <sub>IN</sub> = 12 V, POL is disabled via ON/OFF		20		mADC
Input Reflected Ripple Current Peak-to-Peak	BW = 5 MHz to 20 MHz, L <sub>SOURCE</sub> = 1 µH, See Figure 21 for setup		60		mA

# YEVO9T10

## 3.2 OUTPUT SPECIFICATIONS

PARAMETER	CONDITIONS / DESCRIPTION	MIN	NOM	MAX	UNITS
Output Voltage Range ( $V_{OUT}$ )	Programmable with a resistor between TRIM and GND pins	0.59		5.1	VDC
Output Voltage Setpoint Accuracy, $V_{OUT} \geq 1$ V	$V_{IN} = 12$ V, $I_{OUT} = I_{OUT\ MAX}$ , 0.1% trim resistor, room temperature	-1.0		1.0	% $V_{OUT}$
Output Voltage Setpoint Accuracy, $V_{OUT} < 1$ V	$V_{IN} = 12$ V, $I_{OUT} = I_{OUT\ MAX}$ , 0.1% trim resistor, room temperature	-10		10	mVDC
Line Regulation, $V_{OUT} \geq 2.5$ V	$V_{IN\ MIN}$ to $V_{IN\ MAX}$			0.5	% $V_{OUT}$
Load Regulation, $V_{OUT} \geq 2.5$ V	0 to $I_{OUT\ MAX}$			0.4	% $V_{OUT}$
Line Regulation, $V_{OUT} < 2.5$ V	$V_{IN\ MIN}$ to $V_{IN\ MAX}$			5	mVDC
Load Regulation, $V_{OUT} < 2.5$ V	0 to $I_{OUT\ MAX}$			10	mVDC
Output Voltage Regulation	Over operating input voltage, resistive load, and temperature conditions until the end of life	-2.0		2.0	% $V_{OUT}$
Output Voltage Peak-to-Peak Ripple and Noise, BW = 20 MHz, Full Load	$V_{IN} = 12$ V, $V_{OUT} = 0.6$ V		10	25	mV
	$V_{IN} = 12$ V, $V_{OUT} = 3.3$ V		15	30	mV
	$V_{IN} = 12$ V, $V_{OUT} = 5.0$ V		25	40	mV
Dynamic Regulation Peak Deviation Settling Time	$V_{IN} = 12$ V, 50 - 100% load step, Slew rate 1A/ $\mu$ s, to 10% of peak deviation		140	250	mV
	$V_{OUT} = 0.6$ V		50	100	$\mu$ s
Efficiency $V_{IN} = 12$ V Full Load Room temperature	$V_{OUT} = 0.6$ V		67		%
	$V_{OUT} = 0.8$ V		75		%
	$V_{OUT} = 1.2$ V		81		%
	$V_{OUT} = 1.5$ V		84		%
	$V_{OUT} = 1.8$ V		85		%
	$V_{OUT} = 2.5$ V		89		%
Switching Frequency	$V_{OUT} = 3.3$ V		91		%
	$V_{OUT} = 5.0$ V		93		%
			500		kHz
Output Current ( $I_{OUT}$ )	$V_{IN\ MIN}$ to $V_{IN\ MAX}$	0		10	ADC
Turn-On Delay Time <sup>1</sup> POL is Enabled	ON/OFF pin is pulled high From $V_{IN} = V_{IN\ MIN}$ to $V_{OUT} = 0.1 \cdot V_{OUT\ SET}$		0.4	1	ms
Turn-On Delay Time <sup>2</sup> POL is Disabled	$V_{IN} = 12$ V From ON/OFF pin changing its state from low to high until $V_{OUT} = 0.1 \cdot V_{OUT\ SET}$		0.3	1	ms
Rise Time <sup>2</sup> $C_{OUT} = 0$ $\mu$ F, Resistive Load	From $V_{OUT} = 0.1 \cdot V_{OUT\ SET}$ to $V_{OUT} = 0.9 \cdot V_{OUT\ SET}$		1.3	2	ms
Admissible Output Capacitance	$I_{OUT} = I_{OUT\ MAX}$ , Resistive load, ESR > 1 m $\Omega$			1140	$\mu$ F

## 3.3 PROTECTION SPECIFICATIONS

PARAMETER	CONDITIONS / DESCRIPTION	MIN	NOM	MAX	UNITS
<b>Output Overcurrent Protection</b>					
Type			Auto-Restart		
Inception Point		105	150	180	% $I_{OUT}$
Output Short Circuit Current (RMS value)	$R_{OUT} < 0.01$ $\Omega$		2	5	A
<b>Output Overvoltage Protection</b>					
Type			Auto-Restart		
Threshold	$I_{OUT} = I_{OUT\ MAX}$ , room temperature	112	115	118	% $V_{O\ SET}$

<sup>1</sup> Total start-up time is the sum of the turn-on delay time and the rise time

## 3.4 FEATURE SPECIFICATIONS

PARAMETER	CONDITIONS / DESCRIPTION	MIN	NOM	MAX	UNITS
<i>Enable (ON/OFF pin)</i>					
ON/OFF Logic	Positive (enables the output when ON/OFF pin is open or pulled high)				
ON/OFF High Input Voltage	POL is ON	2.4		5.5	VDC
ON/OFF High Input Current	POL is ON			1.0	mADC
ON/OFF Low Input Voltage	POL is OFF	-0.3		0.4	VDC
ON/OFF Low Input Current	POL is OFF			0.55	mADC

## 4. TYPICAL PERFORMANCE CHARACTERISTICS

### 4.1 EFFICIENCY CURVES

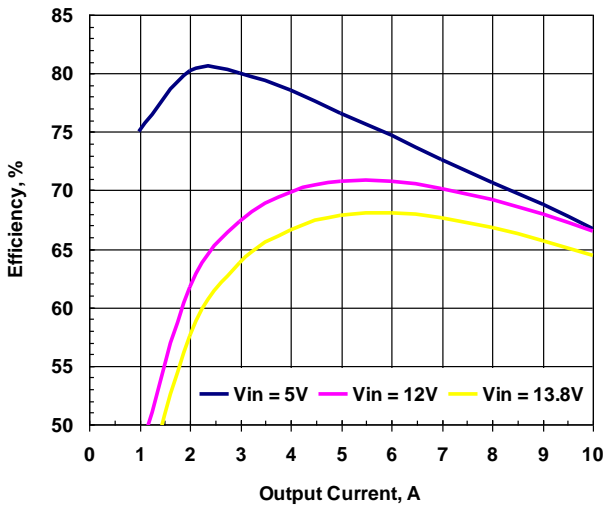

Figure 1. Efficiency vs. Load.  $V_{out}=0.6V$

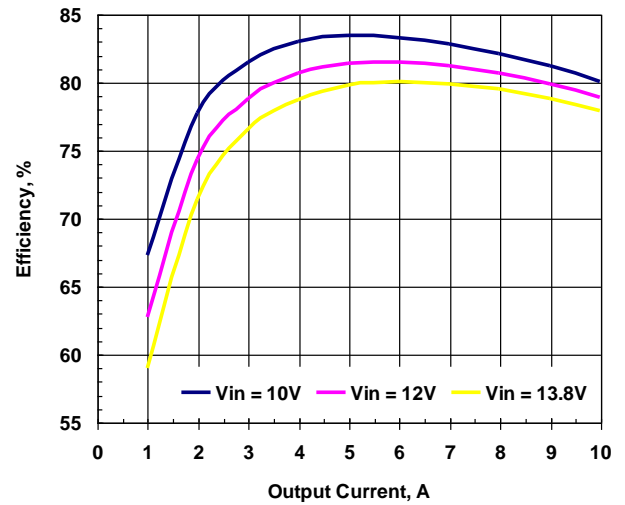

Figure 2. Efficiency vs. Load.  $V_{out}=1.2V$

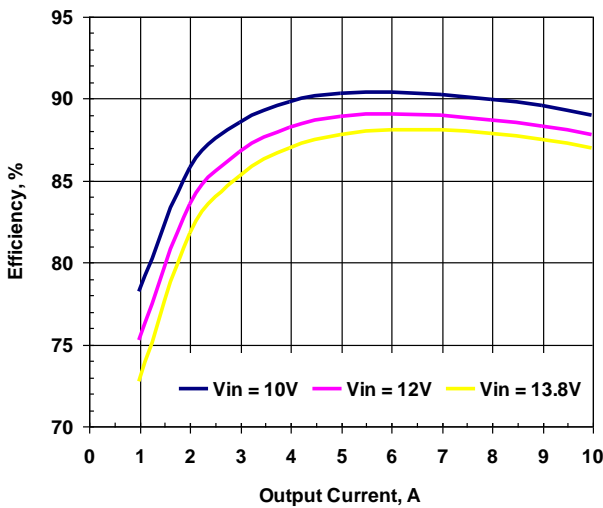

Figure 3. Efficiency vs. Load.  $V_{out}=2.5V$

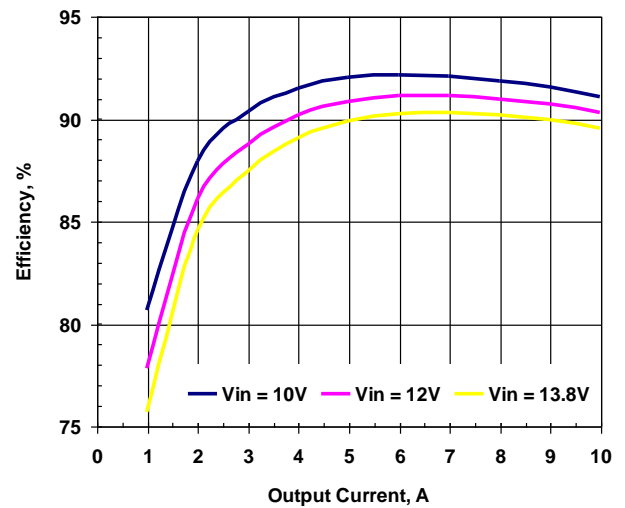

Figure 4. Efficiency vs. Load.  $V_{out}=3.3V$

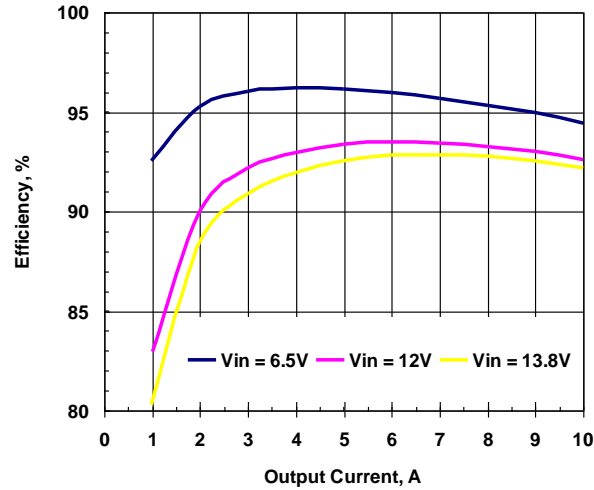

Figure 5. Efficiency vs. Load.  $V_{out}=5.0V$

### 4.2 TURN-ON CHARACTERISTICS

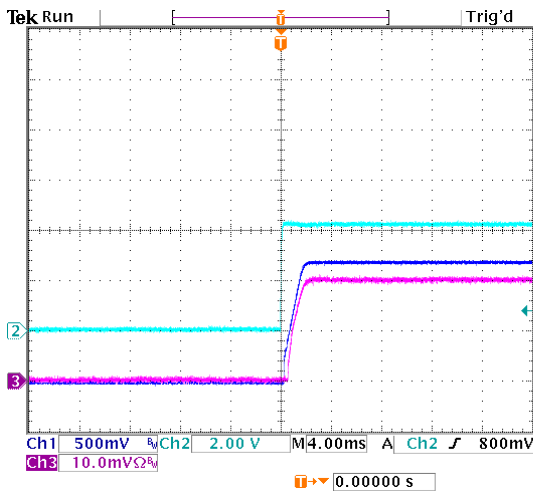

Figure 6. Typical Start-Up Using Remote On/Off ( $V_o = 1.2Vdc$ ,  $I_o=10A$ ). Ch1 -  $V_{out}$ , Ch2 - ON/OFF, Ch3 -  $I_{out}$

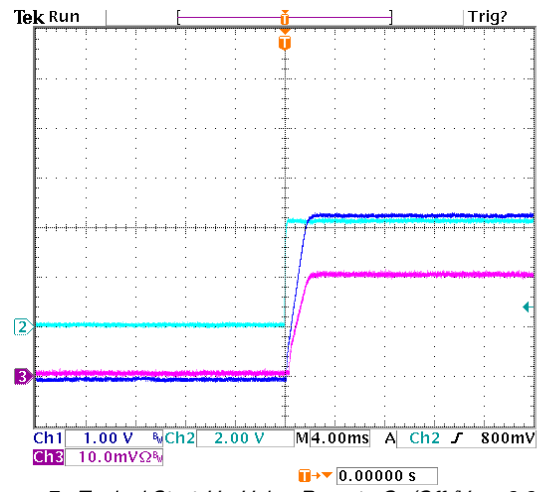

Figure 7. Typical Start-Up Using Remote On/Off ( $V_o = 3.3Vdc$ ,  $I_o=10A$ ). Ch1 -  $V_{out}$ , Ch2 - ON/OFF, Ch3 -  $I_{out}$

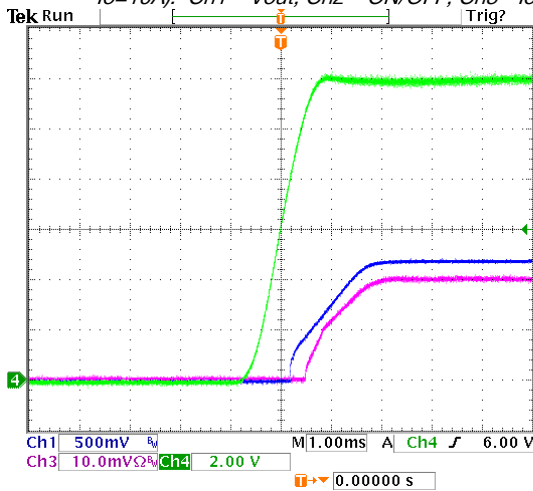

Figure 8. Typical Start-Up with application of  $V_{in}$  ( $V_o = 1.2Vdc$ ,  $I_o = 10A$ ). Ch1 -  $V_{out}$ , Ch3 -  $I_{out}$ , Ch4 -  $V_{in}$ .

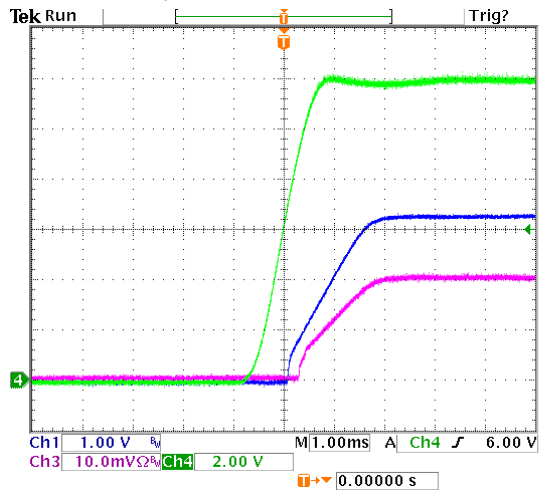

Figure 9. Typical Start-Up with application of  $V_{in}$  ( $V_o = 3.3Vdc$ ,  $I_o = 10A$ ). Ch1 -  $V_{out}$ , Ch3 -  $I_{out}$ , Ch4 -  $V_{in}$ .

4.3 TRANSIENT RESPONSE

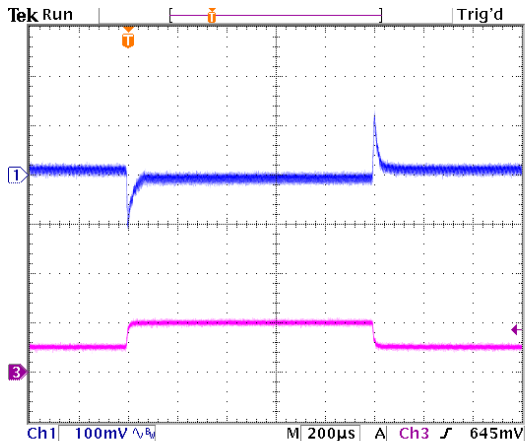

Figure 10. Transient Response to Dynamic Load Change from 50% to 100% of full load ( $V_{in}=12V$ ,  $V_o=0.6Vdc$ ). Ch3 –  $i_{out}$ . Scale=10A/div

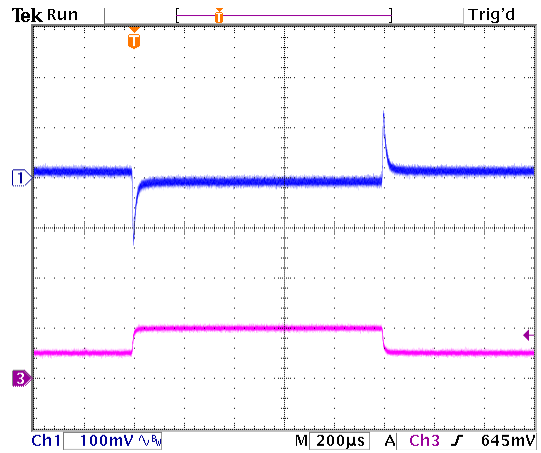

Figure 11. Transient Response to Dynamic Load Change from 50% to 100% of full load ( $V_{in}=12V$ ,  $V_o=3.3Vdc$ ). Ch3 –  $i_{out}$ . Scale=10A/div

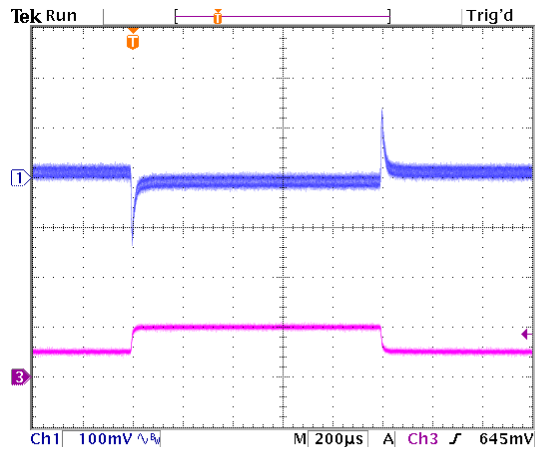

Figure 12. Transient Response to Dynamic Load Change from 50% to 100% of full load ( $V_{in}=12V$ ,  $V_o=5.0Vdc$ ). Ch3 –  $i_{out}$ . Scale=10A/div

## 4.4 DERATING CURVES

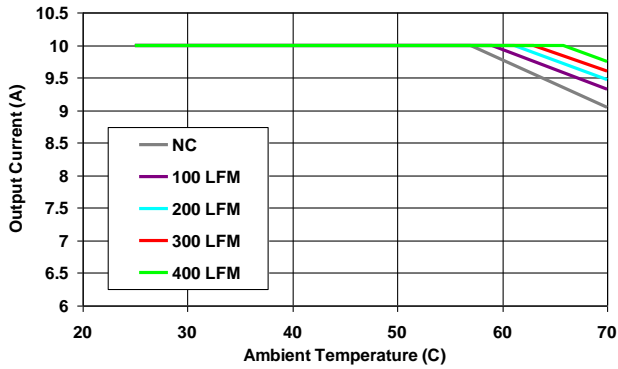

Figure 13. Derating Curves at  $V_o=0.6Vdc$

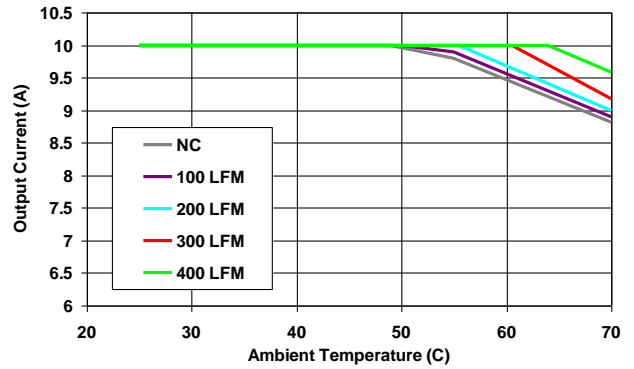

Figure 14. Derating Curves at  $V_o=1.2Vdc$

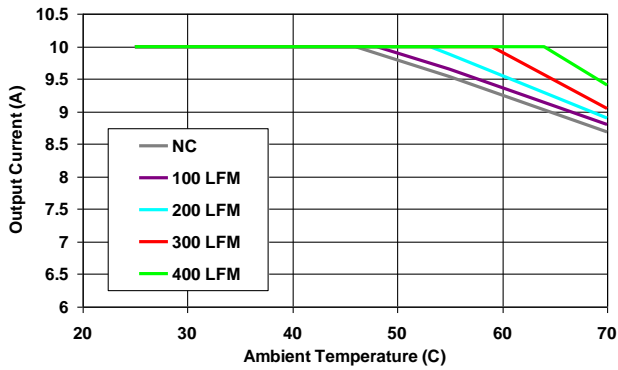

Figure 15. Derating Curves at  $V_o=1.8Vdc$  and 300LFM

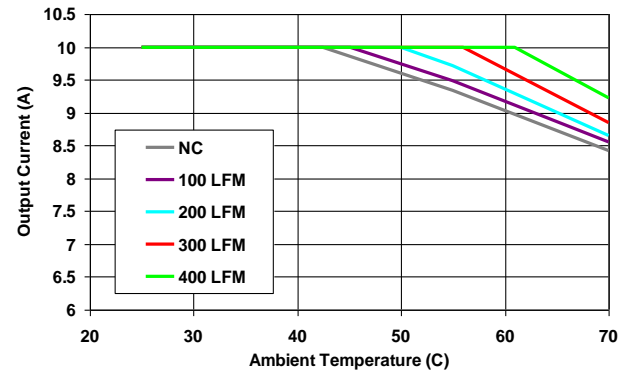

Figure 16. Derating Curves at  $V_o=2.5Vdc$

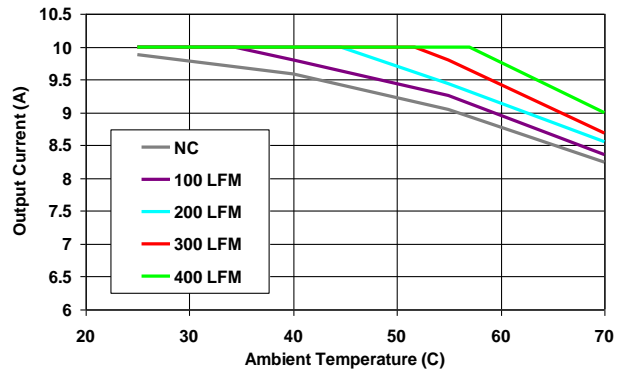

Figure 17. Derating Curves at  $V_o=3.3Vdc$

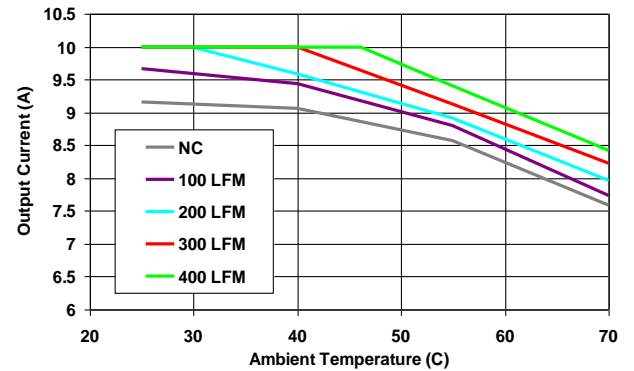

Figure 18. Derating Curves at  $V_o=5.0Vdc$

# YEVO9T10

## 5. APPLICATION INFORMATION

### 5.1 INPUT AND OUTPUT IMPEDANCE

The POL converter should be connected to the DC power source via low impedance. In many applications, the inductance associated with the distribution from the power source to the input of the converter can affect the stability of the converter. Internally, the converter includes 4.7µF (low ESR ceramics) of input capacitance which eliminates the need for external input capacitance. However, if the distribution of the input voltage to the POL converter contains high inductance, it is recommended to add a 100µF decoupling capacitor placed as close as possible to the converter input pins. A low-ESR tantalum or POS capacitor connected across the input pins help ensuring stability of the POL converter and reduce input ripple voltage.

A 22µF ceramic output capacitor is recommended to improve output ripple and dynamic response.

It is important to keep low resistance and low inductance of PCB traces for connecting load to the output pins of the converter in order to maintain good load regulation.

### 5.2 OUTPUT VOLTAGE PROGRAMMING

The output voltage can be programmed from 0.59 V to 5.1 V by connecting an external resistor  $R_{TRIM}$  between TRIM pin (Pin 5) and GND pin (Pin 3), as shown in Figure 19.

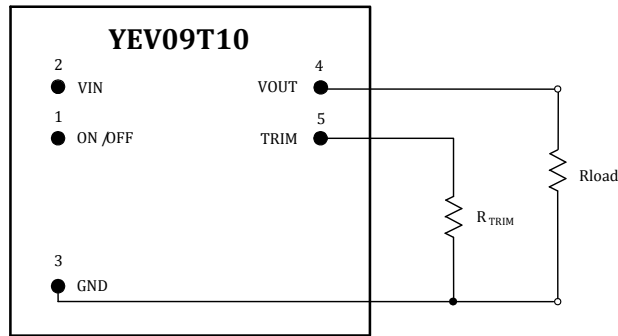

Figure 19. Programming Output Voltage with a Resistor

The trim resistor  $R_{TRIM}$  for a desired output voltage can be calculated using the following equation:

$$R_{TRIM} = \frac{1.182}{V_{OUT} - 0.591}, \text{ k}\Omega$$

where:

$V_{OUT}$  = Desired (trimmed) value of output voltage V

$R_{TRIM}$  = Required value of the trim resistor in kΩ

If the  $R_{TRIM}$  is not used, the output voltage of the POL converter will be 0.591 V.

Note that the trim resistor tolerance directly affects the output voltage accuracy. It is recommended to use ±0.1% trim resistors to meet the output voltage setpoint accuracy specified in p. 1.1.

$V_{OUT}$ , V	Calculated $R_{TRIM}$ , kΩ	Standard Value of 0.1% Resistor, kΩ
0.8	5.65	5.62
1.2	1.94	1.93
1.5	1.3	1.30
1.8	0.98	0.976
2.5	0.62	0.619
3.3	0.44	0.437
5.0	0.27	0.267

Table 1. Trim Resistor Values



# YEV09T10

## 5.3 ON/OFF (PIN 1)

The ON/OFF pin is used to turn the POL converter ON or OFF remotely by a signal from a system controller. For positive logic, the POL converter is ON when the ON/OFF pin is at a logic high (2.4V min) or left open. The POL converter is OFF when the ON/OFF pin is at a logic low (0.4V max) or connected to GND.

The ON/OFF pin should be controlled with an open collector transistor as shown in Figure 20.

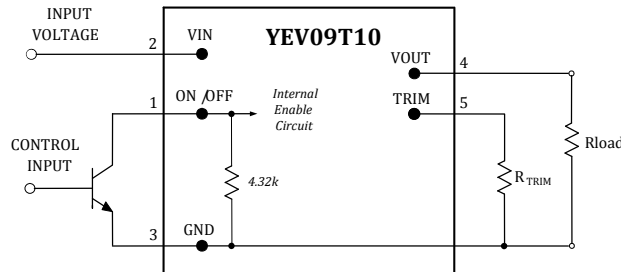

Figure 20. Circuit Configuration For ON/OFF Function

## 5.4 PROTECTIONS

### 5.4.1 INPUT UNDERVOLTAGE LOCKOUT

The POL converter will shut down when the input voltage drops below a predetermined voltage. It will start automatically when the input voltage exceeds the specified threshold.

### 5.4.2 OUTPUT OVERCURRENT PROTECTION

The POL converter is protected against overcurrent and short circuit conditions. Upon sensing an overcurrent condition, the POL converter will enter hiccup mode of operation. Once the overload or short circuit condition is removed, the POL converter will automatically restart and V<sub>out</sub> will return to its nominal value.

### 5.4.3 OUTPUT OVERVOLTAGE PROTECTION

The POL converter is protected against overvoltage on the output. If the output voltage is higher than 115% of its nominal value set by the R<sub>TRIM</sub>, the high side MOSFET will be immediately turned off and the low side MOSFET will be turned on. The POL converter will remain in the state until the output voltage reduces below 115% of its nominal value. At that point the POL converter will automatically restart.

## 6. CHARACTERIZATION

### 6.1 RIPPLE AND NOISE

The output voltage ripple and input reflected ripple current waveforms are measured using the test setup shown in Figure 21.

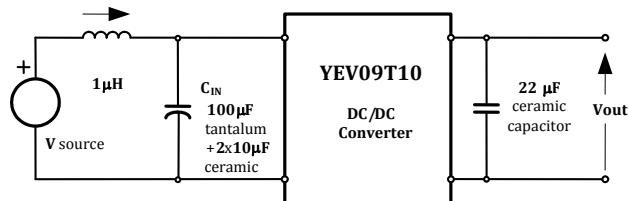

Figure 21. Test Setup for Measuring Input Reflected-Ripple Current and Output Voltage Ripple

# YEVO9T10

## 7. SAFETY

The YEVO9T10 POL converters **do not provide isolation** from input to output. The input devices powering YEVO9T10 must provide relevant isolation requirements according to all IEC60950 based standards. Nevertheless, if the system using the converter needs to receive safety agency approval, certain rules must be followed in the design of the system. In particular, all of the creepage and clearance requirements of the end-use safety requirements must be observed. These requirements are included in CSA/UL60950 and EN60950, although specific applications may have other or additional requirements.

The YEVO9T10 POL converters have no internal fuse. If required, the external fuse needs to be provided to protect the converter from catastrophic failure. Refer to the “Input Fuse Selection for DC/DC converters” application note on [www.belpowersolutions.com](http://www.belpowersolutions.com) for proper selection of the input fuse. Both input traces and the chassis ground trace (if applicable) must be capable of conducting a current of 1.5 times the value of the fuse without opening.

To comply with safety agencies’ requirements, a recognized fuse must be used in series with the input line. The fuse must not be placed in the grounded input line. Abnormal and component failure tests were conducted with the POL input protected by a fast-acting 25 A fuse. If a fuse rated greater than 25 A is used, additional testing may be required.

The maximum DC voltage between any two pins is  $V_{in}$  under all operating conditions. In order for the output of the YEVO9T10 POL converter to be considered as SELV (Safety Extra Low Voltage), according to all IEC60950 based standards, the input to the POL needs to be supplied by an isolated secondary source providing a SELV also.

## 8. PIN ASSIGNMENTS AND DESCRIPTION

PIN NAME	PIN NUMBER	PIN TYPE	BUFFER TYPE	PIN DESCRIPTION	NOTES
ON/OFF	1	I	PU	Enable	Pull high to turn ON the POL
VIN	2	P		Input Voltage	
GND	3	P		Power Ground	
VOUT	4	P		Output Voltage	
TRIM	5	I	A	Output Voltage Trim	Connect a high accuracy resistor between TRIM and GMD pins to set the output voltage

Legend: I=input, O=output, I/O=input/output, P=power, A=analog, PU=internal pull-up

## 9. MECHANICAL DRAWINGS

**NOTE:** All Dimensions are in inches. Tolerances: X.XX:  $\pm 0.02$ " X.XXX:  $\pm 0.01$ "

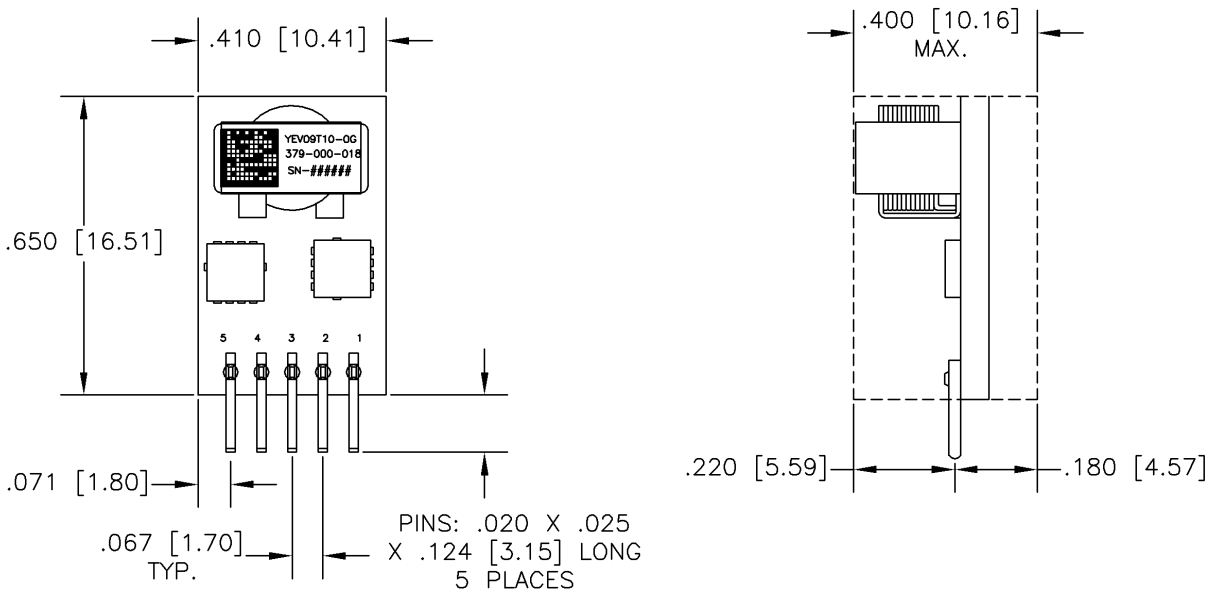

Figure 22. Mechanical Drawing

# YEV09T10

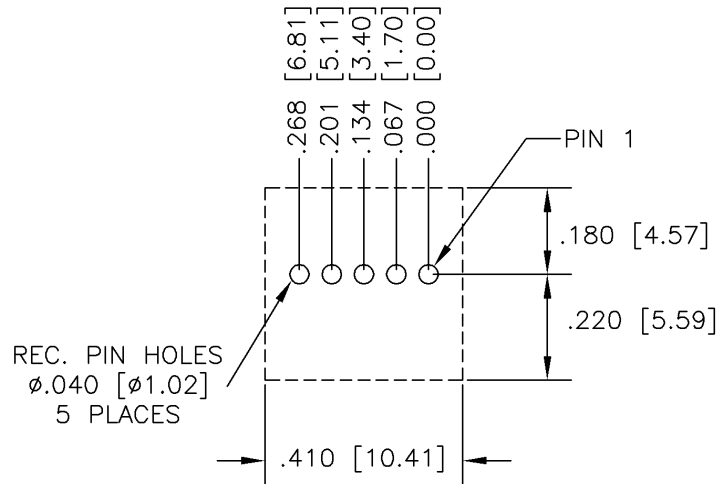

Figure 23. Recommended Footprint – Top View

## 10. ORDERING INFORMATION

YE	V	09	T	10	-	0	z
PRODUCT FAMILY	PROFILE	INPUT VOLTAGE	PCB MOUNTING	OUTPUT CURRENT	DASH	OPTIONS	ROHS COMPLIANCE
POL Converter	Vertical	4.5 V to 13.8 V	Through-hole	10 A		<b>0</b> – 0 to 70 °C operating range. <b>R</b> – -40 to 85 °C operating range.	<b>No suffix</b> - RoHS compliant with Pb solder exemption <sup>2</sup> <b>G</b> - RoHS compliant for all six substances

Example: **YEV09T10-0G**: YEV09T10 POL converter with the commercial temperature range and lead-free solder.

**For more information on these products consult: [tech.support@psbel.com](mailto:tech.support@psbel.com)**

**NUCLEAR AND MEDICAL APPLICATIONS** - Products are not designed or intended for use as critical components in life support systems, equipment used in hazardous environments, or nuclear control systems.

**TECHNICAL REVISIONS** - The appearance of products, including safety agency certifications pictured on labels, may change depending on the date manufactured. Specifications are subject to change without notice.

<sup>2</sup> The solder exemption refers to all the restricted materials except lead in solder. These materials are Cadmium (Cd), Hexavalent chromium (Cr6+), Mercury (Hg), Polybrominated biphenyls (PBB), Polybrominated diphenylethers (PBDE), and Lead (Pb) used anywhere except in solder.

# Mouser Electronics

Authorized Distributor

Click to View Pricing, Inventory, Delivery & Lifecycle Information:

[Bel Power Solutions:](#)

[YEV09T10-0G](#)