

ITEM	Q'TY	PART NUMBER	PART DESCRIPTION
1	1	ORFLP2-XXX	2mm Flexible Light Pipe ORCA Adapter w/ LED
2	1	FLPF-XX.X	Flexible Light Pipe Lens Cap Assembly, Flat

REV.	DESCRIPTION	DATE	APPROVED
A	Engineering Release.	09/14/09	T. Y.
B	Updated Table For Length "X.X"	11/14/12	T. Y.
C	Updated LED Optical Characteristics.	08/29/15	J. C.

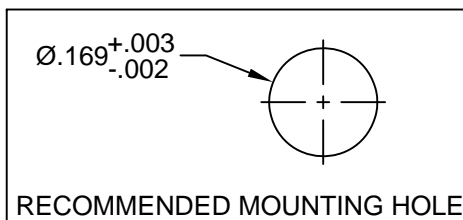

RECOMMENDED MOUNTING HOLE

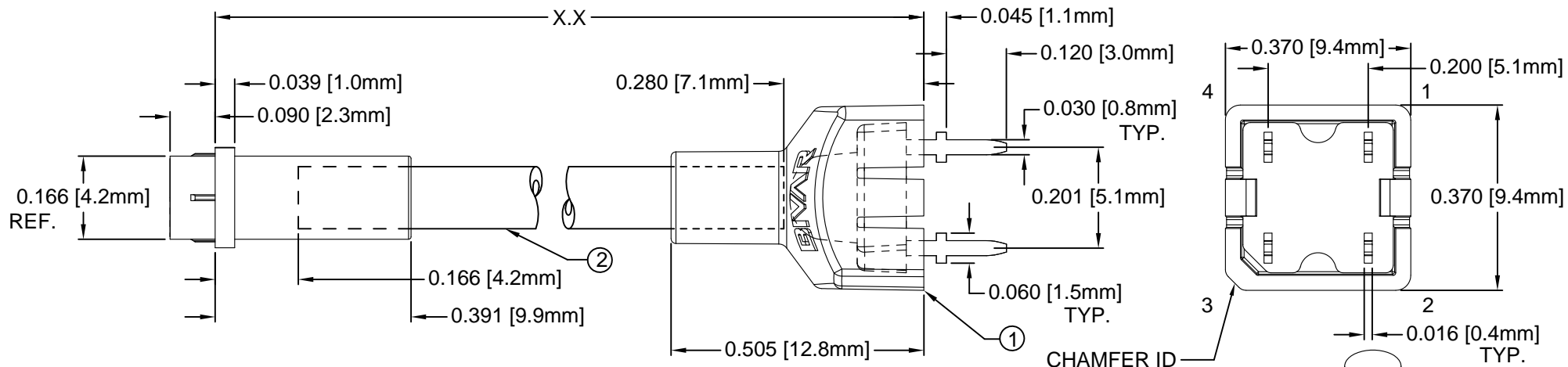
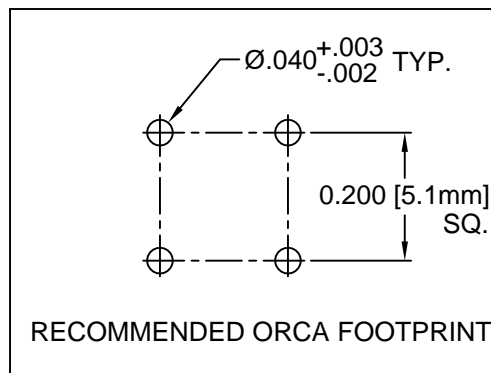

RECOMMENDED ORCA FOOTPRINT

"X.X" *	Tolerance
1.0" ~ 16.0"	±0.050"
16.1" ~ 40.0"	±0.15"
40.1" ~ 80.0"	±0.30"
80.1" ~ 3,940.0"	±0.5%

* Available in 0.1" increments only

NOTE: ORFLP2-XXX ADAPTER SHIPPED SEPARATELY

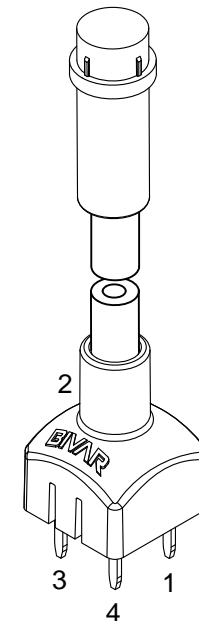

SEE PAGE 2 FOR POLARITY

ABSOLUTE MAXIMUM RATINGS (Ta=25°C)

REVERSE VOLTAGE _____	5V
REVERSE CURRENT _____	10uA
OPERATING TEMPERATURE RANGE _____	-25°C ~ +80°C
STORAGE TEMPERATURE _____	-30°C ~ +80°C
LEAD SOLDERING TEMPERATURE(1/16" FROM BODY) _____	260°C FOR 5 SECONDS

STANDARD TOLERANCE (UNLESS OTHERWISE SPECIFIED)		BIVAR®	
DECIMALS	ANGULAR	4 THOMAS, IRVINE, CA. 92618	
.X ±.2	X° ± 1°	TEL: (949) 951-8808 FAX: (949) 951-3974	
.XX ±.02		TITLE: 2mm FLP ORCA ASSEMBLY, FLAT LENS CAP	
.XXX ±.010		PART NO: R2F-X.X-XXX	
DESIGNED: Raffy Paje	DATE: 09/14/09	REVISION: C	
CHECKED: F. Jensen	DATE: 09/14/09	CAGE CODE : 32559	SHEET # 1 OF 2
CAD GENERATED DOCUMENT. DO NOT MEASURE DRAWING.			

REV.	DESCRIPTION	DATE	APPROVED
	SEE SHEET #1		

Assy P/N	LED P/N	Emitted Color	Dominant Length λ_d (nm) / CCT (K)	Lens Appearance	Absolute Max. Ratings			Vf (V)			Iv (mcd)		Viewing Angle $2\theta_{1/2}$ (Deg)	POLARITY DIAGRAM
					Pd (mW)	If (mA)	Peak If (mA)	MIN	TYP	MAX	MIN	TYP		
SINGLE COLOR LED ASSEMBLIES (20mA)														
R2F-X.X-BLU	R20BLU-4-0045	BLUE	465 - 475	WATER CLEAR	220	50	100	2.7	3.2	3.6	5000	8000	45	FIG. A
R2F-X.X-GRN	R20GRN-4-0045	GREEN	517 - 527		220	50	100	2.7	3.2	3.6	15000	25000	45	FIG. A
R2F-X.X-WHT	R20WHT-4-0045	WHITE	6000K		220	50	100	2.7	3.2	3.6	10000	16000	45	FIG. A
SINGLE COLOR LED ASSEMBLIES (50mA)														
R2F-X.X-RED	R50RED-4-0045	RED	620 - 635	WATER CLEAR	140	80	160	1.8	2.4	2.6	12000	18000	45	FIG. A
R2F-X.X-YLW	R50YLW-4-0045	YELLOW	588 - 596		140	80	160	1.8	2.4	2.6	12000	18000	45	FIG. A
BI-COLOR LED ASSEMBLIES (50mA)														
R2F-X.X-RG	R50RG2-4-0045	RED	617 - 630	WATER CLEAR	150	80	160	1.8	2.4	2.6	3000	4000	45	FIG. B
		GREEN	515 - 525		220	80	150	3.0	3.4	3.8	6000	10000		
R2F-X.X-RB	R50RB2-4-0045	RED	617 - 630	WATER CLEAR	150	80	160	1.8	2.4	2.6	3000	4000	45	FIG. C
		BLUE	460 - 470		220	80	150	3.0	3.4	3.8	1000	3000		
R2F-X.X-BG	R50BG2-4-0045	BLUE	460 - 470	WATER CLEAR	220	80	150	3.0	3.4	3.8	1000	3000	45	FIG. D
		GREEN	515 - 525		220	80	150	3.0	3.4	3.8	6000	10000		
R2F-X.X-RGB	R50RGB-4-0045	RED	617 - 630	WATER CLEAR	150	80	160	1.8	2.4	2.6	3000	4000	45	FIG. E
		GREEN	515 - 525		220	80	150	3.0	3.4	3.8	6000	10000		
		BLUE	460 - 470		220	80	150	3.0	3.4	3.8	1000	3000		

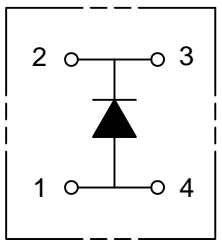

FIG. A

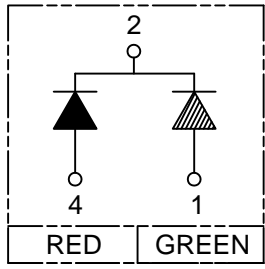

FIG. B

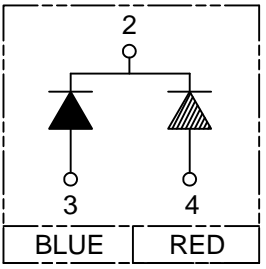

FIG. C

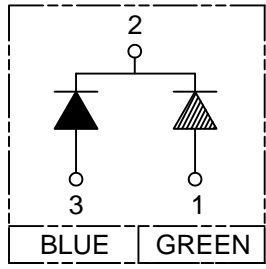

FIG. D

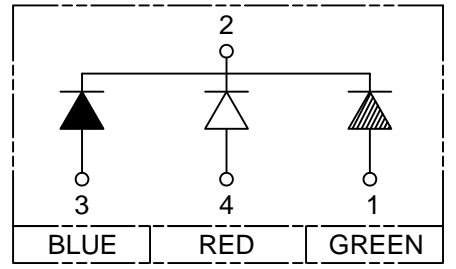

FIG. E

NOTES:
1. INDIVIDUAL LED P/N DATA AVAILABLE @ WWW.BIVAR.COM.

STANDARD TOLERANCE (UNLESS OTHERWISE SPECIFIED) DECIMALS ANGULAR		BIVAR [®] 4 THOMAS, IRVINE, CA. 92618 TEL: (949) 951-8808 FAX: (949) 951-3974	
		TITLE: 2mm FLP ORCA ASSEMBLY, FLAT LENS CAP	
DESIGNED: Raffy Paje	DATE: 09/14/09	PART NO: R2F-X.X-XXX	REVISION: C
CHECKED: F. Jensen	DATE: 09/14/09	CAGE CODE : 32559	SHEET # 2 OF 2
CAD GENERATED DOCUMENT. DO NOT MEASURE DRAWING.			

Mouser Electronics

Authorized Distributor

Click to View Pricing, Inventory, Delivery & Lifecycle Information:

BIVAR:

[R2F-4.0-BLU](#) [R2F-8.0-BLU](#) [R2F-12.0-BLU](#) [R2F-4.0-GRN](#) [R2F-8.0-GRN](#) [R2F-12.0-GRN](#) [R2F-8.0-RED](#) [R2F-4.0-RED](#) [R2F-12.0-RED](#) [R2F-4.0-WHT](#) [R2F-8.0-WHT](#) [R2F-12.0-WHT](#) [R2F-1.5-BLU](#) [R2F-1.5-GRN](#) [R2F-1.5-RED](#) [R2F-1.5-WHT](#) [R2F-10.0-BLU](#) [R2F-10.0-GRN](#) [R2F-10.0-RED](#) [R2F-10.0-WHT](#) [R2F-10.5-BLU](#) [R2F-10.5-GRN](#) [R2F-10.5-RED](#) [R2F-10.5-WHT](#) [R2F-11.0-BLU](#) [R2F-11.0-GRN](#) [R2F-11.0-RED](#) [R2F-11.0-WHT](#) [R2F-11.5-BLU](#) [R2F-11.5-GRN](#) [R2F-11.5-RED](#) [R2F-11.5-WHT](#) [R2F-2.0-BLU](#) [R2F-2.0-GRN](#) [R2F-2.0-RED](#) [R2F-2.0-WHT](#) [R2F-2.5-BLU](#) [R2F-2.5-GRN](#) [R2F-2.5-RED](#) [R2F-2.5-WHT](#) [R2F-3.0-BLU](#) [R2F-3.0-GRN](#) [R2F-3.0-RED](#) [R2F-3.0-WHT](#) [R2F-3.5-BLU](#) [R2F-3.5-GRN](#) [R2F-3.5-RED](#) [R2F-3.5-WHT](#) [R2F-4.5-BLU](#) [R2F-4.5-GRN](#) [R2F-4.5-RED](#) [R2F-4.5-WHT](#) [R2F-5.0-BLU](#) [R2F-5.0-GRN](#) [R2F-5.0-RED](#) [R2F-5.0-WHT](#) [R2F-5.5-BLU](#) [R2F-5.5-GRN](#) [R2F-5.5-RED](#) [R2F-5.5-WHT](#) [R2F-6.0-BLU](#) [R2F-6.0-GRN](#) [R2F-6.0-RED](#) [R2F-6.0-WHT](#) [R2F-6.5-BLU](#) [R2F-6.5-GRN](#) [R2F-6.5-RED](#) [R2F-6.5-WHT](#) [R2F-7.0-BLU](#) [R2F-7.0-GRN](#) [R2F-7.0-RED](#) [R2F-7.0-WHT](#) [R2F-7.5-BLU](#) [R2F-7.5-GRN](#) [R2F-7.5-RED](#) [R2F-7.5-WHT](#) [R2F-8.5-BLU](#) [R2F-8.5-GRN](#) [R2F-8.5-RED](#) [R2F-8.5-WHT](#) [R2F-9.0-BLU](#) [R2F-9.0-GRN](#) [R2F-9.0-RED](#) [R2F-9.0-WHT](#) [R2F-9.5-BLU](#) [R2F-9.5-GRN](#) [R2F-9.5-RED](#) [R2F-9.5-WHT](#)