

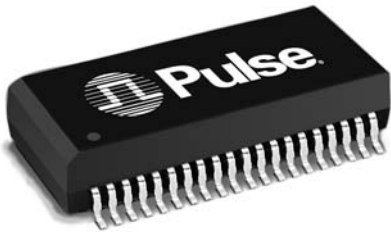







# T1/CEPT/ISDN-PRI TRANSFORMER

## Quad Port SMT Transformer Module with IC Side Protection



-  Eight transformers in a low profile surface mount package
-  Includes IC Side Protection Circuit on each channel to suppress low voltage transients
-  Compatible with PMC-Sierra's Comet chip (PM4354)
-  Patented "Interlock Base" construction for high reliability
-  IC grade transfer-molded package withstands 235°C IR reflow
-  Minimum Isolation voltage: 1500 Vrms
-  UL 1950 recognized

### Electrical Specifications @ 25°C — Operating Temperature 0°C to +70°C

Part Number	Turns Ratio (Pri:Sec ±5%)		OCL (mH MIN)	Cw/w (pF MAX)	LL (µH MAX)	Package/Schematic
	TX	RX				
T9021	1:2.42	1:2.42	0.6 & 0.6	35 & 35	.60 & .60	QTERA

NOTE: TX = Transmit channel. RX = Receive channel

### Mechanical

### Schematic

#### QTERA

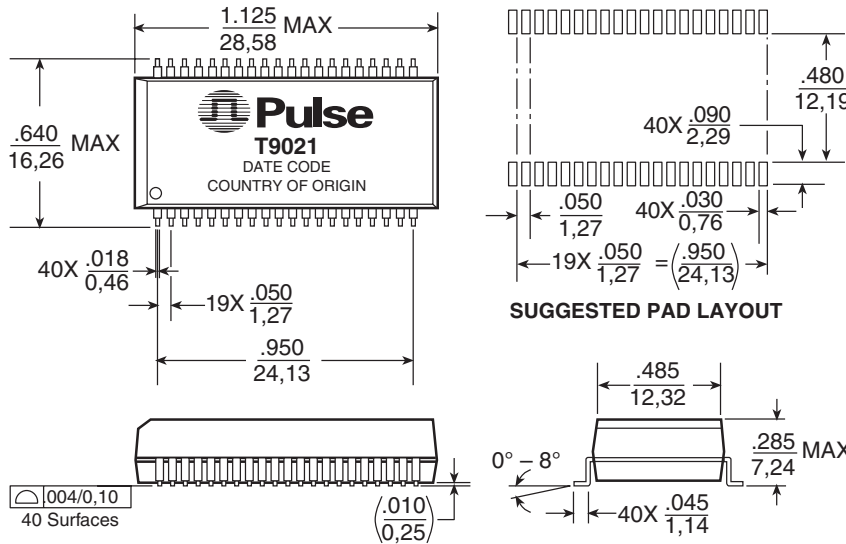

Weight .....5.0 grams  
Tape & Reel.....250/reel  
Tube .....15/tube

Dimensions: Inches  
mm  
Unless otherwise specified, all tolerances are ± .010  
0.25

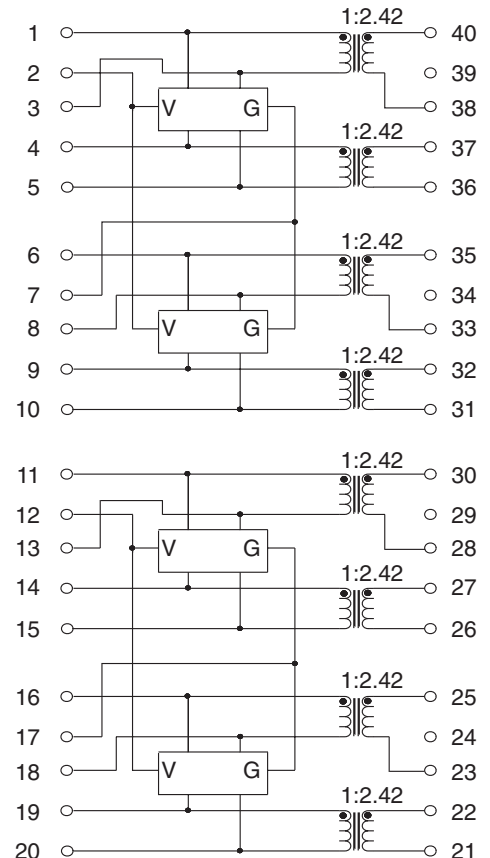

# T1/CEPT/ISDN-PRI TRANSFORMER

## Quad Port SMT Transformer Module with IC Side Protection



### Application Notes

- ET Product** — All coils have an ET product of 10 V- $\mu$ sec minimum.
- Flammability** — Materials used in the products are recognized as UL94-VO approved. Products meet the requirements of IEC 695-2-2 (Needle Flame Test).
- Balance Characteristics** — The transformers meet the requirements for longitudinal balance of FCC part 68.
- Common Mode Rejection Ratio** — the CMRR for all transformers is better than 50 dB at 1 MHz. A typical test circuit is shown below.

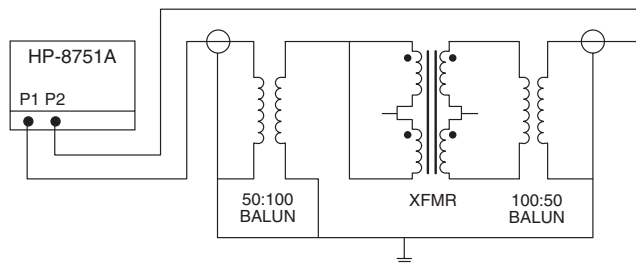

- Crosstalk Attenuation** — In the dual packages, which contain transmit and receive transformers side by side, sufficient crosstalk attenuation is achieved by the inherent characteristics of the toroid cores as well as by their proper positioning. The crosstalk attenuation is typically 50 dB or better from 100 KHz to 10 MHz. This result was established with the test circuit shown below.

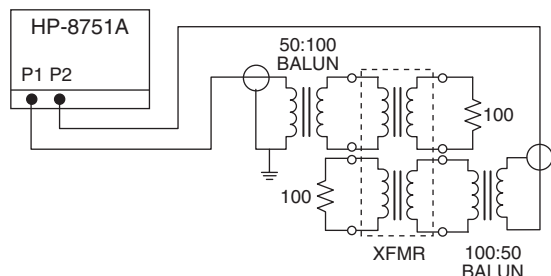

- Return Loss** — ITU-T G.703 and European national regulatory documents specify minimum return loss levels. The transformers will allow these limits to be complied within the situations where they are applicable.

Frequency	50-100 KHz	100 KHz-2 MHz	2-3 MHz
Return Loss			
XMIT	9 dB	15 dB	11 dB
REC	12 dB	18 dB	14 dB

- Surge Voltage Capability** — All transformers and chokes meet surge voltage tests according to the most stringent regulatory documents when system designs include the proper voltage and current suppression devices:

Metallic Voltage: 800 V peak, 10/560  $\mu$ sec  
 Longitudinal Voltage: 2,400 V peak, 10/700  $\mu$ sec

- Isolation Voltage** — 100% of transformers are tested during production to the specified isolation voltage level.
- General Information** — The T9021 is specifically designed for use in 1.544 Mbps (T1), 2.048 Mbps (CEPT) and ISDN Primary rate (PRI) interface applications. They are matched to the majority of the line interface transceiver ICs currently available. Use of the proper transformer allows the interface circuit to comply with ITU-T G.703 and other standards regarding pulse waveform, return loss, and balance.
- Diode Vendor** does not recommend connecting directly to Vcc.

### For More Information:

**Pulse Worldwide Headquarters**  
 12220 World Trade Dr.  
 San Diego, CA 92128  
 U.S.A.  
[www.pulseeng.com](http://www.pulseeng.com)

**Pulse Europe**  
 Einsteinstrasse 1  
 D-71083 Herrenberg  
 Germany

**Pulse China Headquarters**  
 B402, Shenzhen  
 Tech-Innovation International  
 Tenth Kejinan Rd.  
 High-Tech Industrial Park  
 Nanshan District, Shenzhen  
 China

**Pulse North China**  
 Room 1503  
 XinYin Building  
 No. 888 YiShan Rd.  
 Shanghai 200233  
 China

**Pulse South Asia**  
 150 Kampong Ampat  
 #07-01/02  
 KA Centre  
 Singapore 368324

**Pulse North Asia**  
 No. 26  
 Kao Ching Rd.  
 Yang Mei Chen  
 Tao Yuan Hsien  
 Taiwan, R. O. C.

Tel: 858 674 8100  
 Fax: 858 674 8262

Tel: 49 7032 7806 0  
 Fax: 49 7032 7806 12

Tel: 86 755 33966678  
 Fax: 86 755 33966700

Tel: 86 21 54643211/2  
 Fax: 86 21 54643210

Tel: 65 6287 8998  
 Fax: 65 6280 0080

Tel: 886 3 4641811  
 Fax: 886 3 4641911

Performance warranty of products offered on this data sheet is limited to the parameters specified. Data is subject to change without notice. Other brand and product names mentioned herein may be trademarks or registered trademarks of their respective owners. © Copyright, 2007. Pulse Engineering, Inc. All rights reserved.

# Mouser Electronics

Authorized Distributor

Click to View Pricing, Inventory, Delivery & Lifecycle Information:

Pulse:

[T9021](#) [T9021T](#) [T9021NL](#)