



BIPOLAR ANALOG INTEGRATED CIRCUIT

μ PC8230TU

SiGe:C LOW NOISE AMPLIFIER FOR GPS

DESCRIPTION

The μ PC8230TU is a silicon germanium carbon (SiGe:C) monolithic integrated circuit designed as low noise amplifier for GPS. This device exhibits low noise figure and high power gain characteristics, so this IC can improve the sensitivity of GPS receiver. In addition, the μ PC8230TU which is included output matching circuit contributes to reduce external components and system size.

The package is 8-pin lead-less minimold suitable for surface mount.

This IC is manufactured using our UHS4 (Ultra High Speed Process) SiGe:C bipolar process.

FEATURES

- Low noise : NF = 0.85 dB TYP. @ $f_{in} = 1.575$ MHz
- High gain : $G_P = 18.5$ dB TYP. @ $f_{in} = 1.575$ MHz
- Low current consumption : $I_{CC} = 6.0$ mA TYP. @ $V_{CC} = 3.0$ V
- Built-in power-saving function
- High-density surface mounting : 8-pin lead-less minimold package (2.0 × 2.0 × 0.5 mm)
- Included output matching circuit
- Included very robust bandgap regulator (Small V_{CC} and T_A dependence)
- Included protection circuits for ESD

APPLICATION

- Low noise amplifier for GPS

ORDERING INFORMATION

Part Number	Order Number	Package	Marking	Supplying Form
μ PC8230TU-E2	μ PC8230TU-E2-A	8-pin lead-less minimold (Pb-Free)	8230	<ul style="list-style-type: none">• 8 mm wide embossed taping• Pin 5, 6, 7, 8 indicates pull-out direction of tape• Qty 5 kpcs/reel

Remark To order evaluation samples, contact your nearby sales office.

Part number for sample order: μ PC8230TU-A

Caution: Observe precautions when handling because these devices are sensitive to electrostatic discharge

The information in this document is subject to change without notice. Before using this document, please confirm that this is the latest version.

PIN CONNECTIONS AND INTERNAL BLOCK DIAGRAM

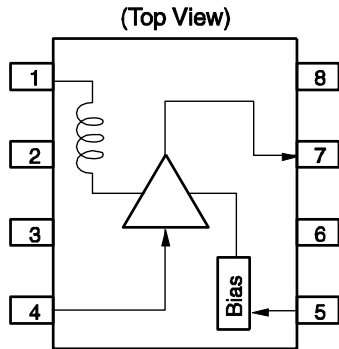

Pin No.	Pin Name
1	Vcc
2	N.C.
3	GND
4	INPUT
5	Power Save
6	GND
7	OUTPUT
8	Vcc

ABSOLUTE MAXIMUM RATINGS

Parameter	Symbol	Test Conditions	Ratings	Unit
Supply Voltage	V _{CC}	T _A = +25°C	4.0	V
Power-Saving Voltage	V _{PS}	T _A = +25°C	4.0	V
Power Dissipation	P _D	T _A = +85°C Note	295	mW
Operating Ambient Temperature	T _A		-40 to +85	°C
Storage Temperature	T _{stg}		-55 to +150	°C
Input Power	P _{in}		+10	dBm

Note Mounted on double-side copper-clad 50 × 50 × 1.6 mm epoxy glass PWB

RECOMMENDED OPERATING RANGE

Parameter	Symbol	MIN.	TYP.	MAX.	Unit
Supply Voltage	V _{CC}	2.7	3.0	3.3	V
Operating Ambient Temperature	T _A	-40	+25	+85	°C
Power Save Turn-on Voltage	V _{PSon}	2.2	-	V _{CC}	V
Power Save Turn-off Voltage	V _{PSoff}	0	-	0.8	V

ELECTRICAL CHARACTERISTICS

($T_A = +25^\circ\text{C}$, $V_{CC} = V_{PS} = 3.0\text{ V}$, $f_{in} = 1\ 575\text{ MHz}$, unless otherwise specified)

Parameter	Symbol	Test Conditions	MIN.	TYP.	MAX.	Unit
Circuit Current	I_{CC}	No Signal ($V_{PS} = 3.0\text{ V}$)	4.5	6.0	8.0	mA
		At Power-Saving Mode ($V_{PS} = 0\text{ V}$)	–	–	1	μA
Power Gain	G_P	$P_{in} = -35\text{ dBm}$	16	18.5	21	dB
Noise Figure	NF		–	0.85	1.15	dB
Input 3rd Order Distortion Intercept Point	IIP_3	$f_{in1} = 1\ 574\text{ MHz}$, $f_{in2} = 1\ 575\text{ MHz}$	–	-5	–	dBm
Input Return Loss	RL_{in}		8	11	–	dB
Output Return Loss	RL_{out}		7	10	–	dB
Isolation	ISL		–	39	–	dB
Gain 1 dB Compression Input Power	$P_{in(1\text{ dB})}$		–	-17	–	dBm

TEST CIRCUIT

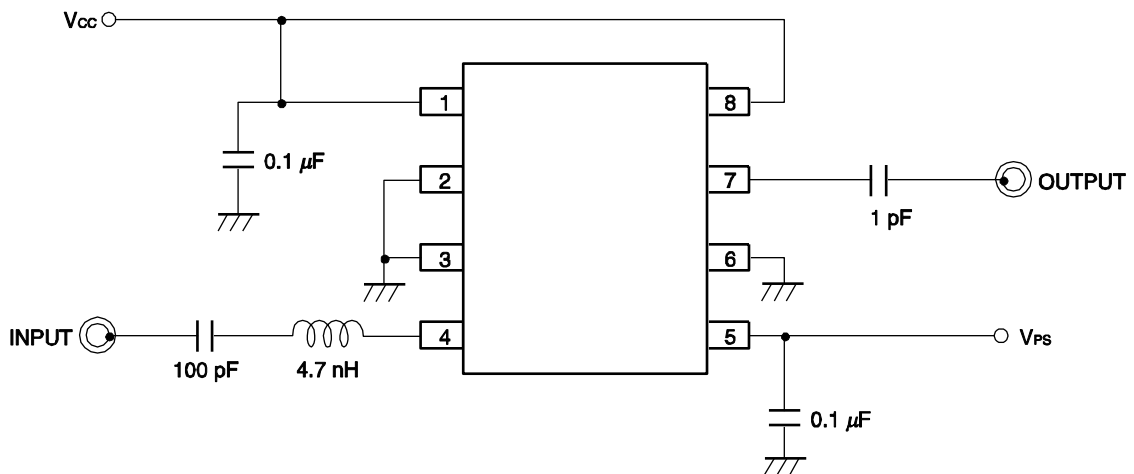

TYPICAL CHARACTERISTICS ($T_A = +25^\circ\text{C}$, unless otherwise specified)

CIRCUIT CURRENT vs. SUPPLY VOLTAGE

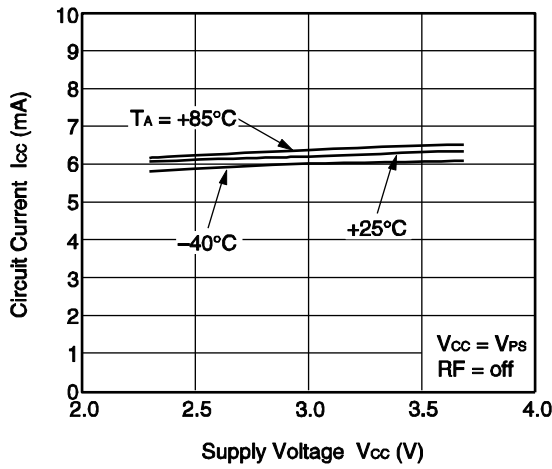

CIRCUIT CURRENT vs. POWER-SAVING VOLTAGE

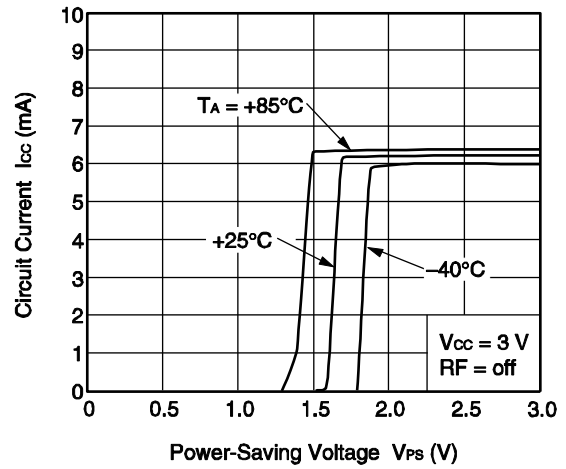

POWER GAIN vs. FREQUENCY

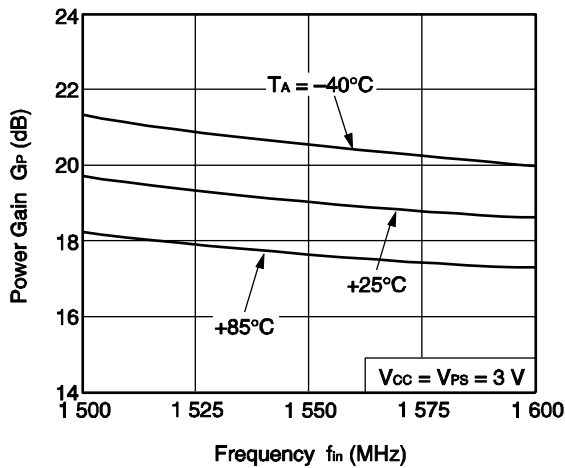

NOISE FIGURE vs. FREQUENCY

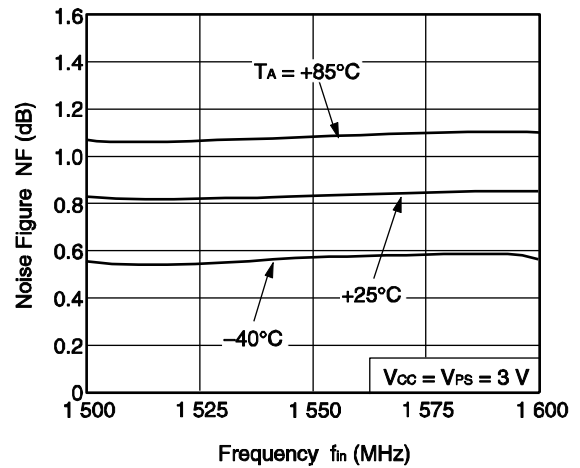

POWER GAIN vs. OPERATING AMBIENT TEMPERATURE

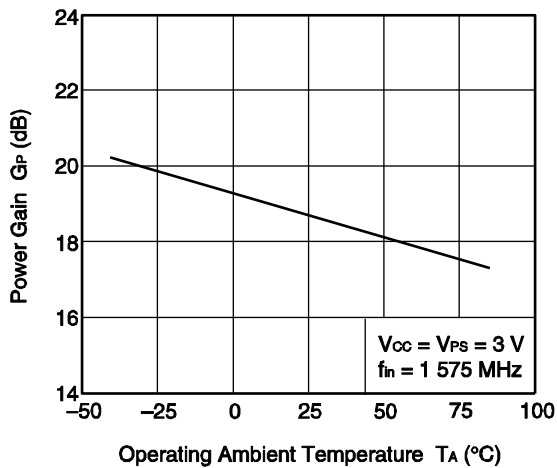

NOISE FIGURE vs. OPERATING AMBIENT TEMPERATURE

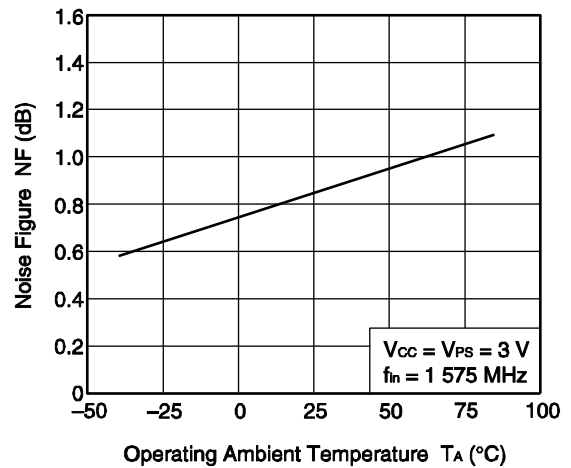

Remark The graphs indicate nominal characteristics.

POWER GAIN vs. SUPPLY VOLTAGE

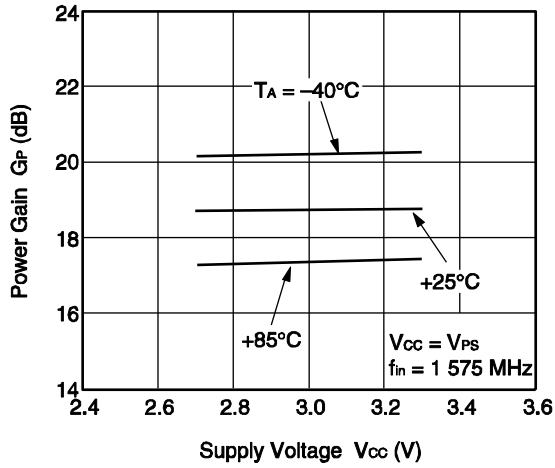

NOISE FIGURE vs. SUPPLY VOLTAGE

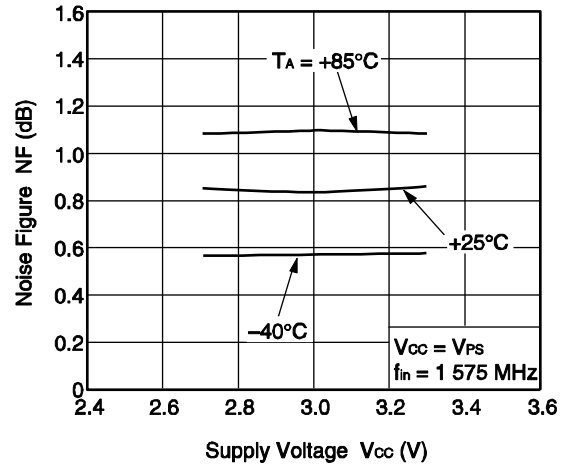

OUTPUT POWER vs. INPUT POWER

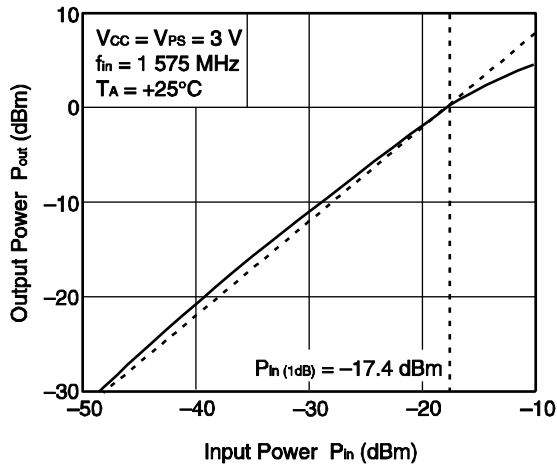

OUTPUT POWER vs. INPUT POWER

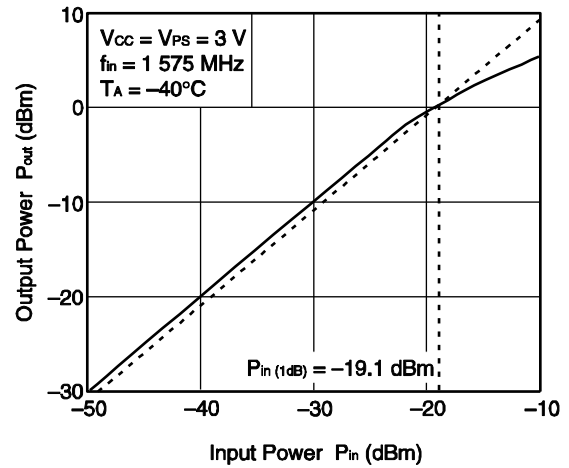

OUTPUT POWER vs. INPUT POWER

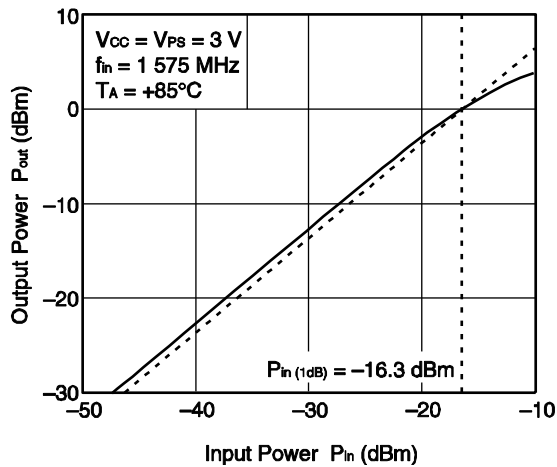

OUTPUT POWER, IM3 vs. INPUT POWER

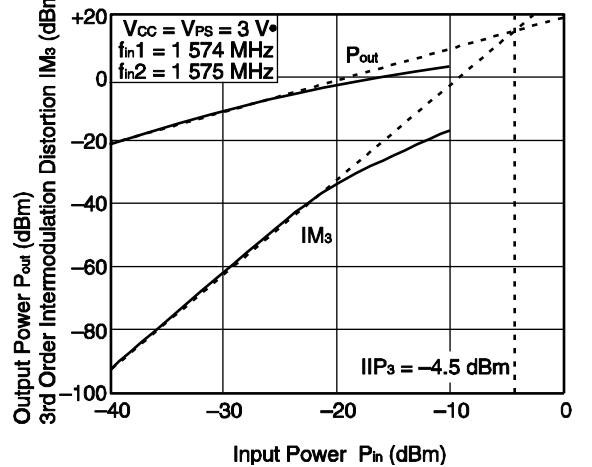

Remark The graphs indicate nominal characteristics.

S-PARAMETERS ($T_A = +25^\circ\text{C}$, $V_{CC} = V_{PS} = 3.0\text{ V}$, monitored at connector on board)

S₁₁-FREQUENCY

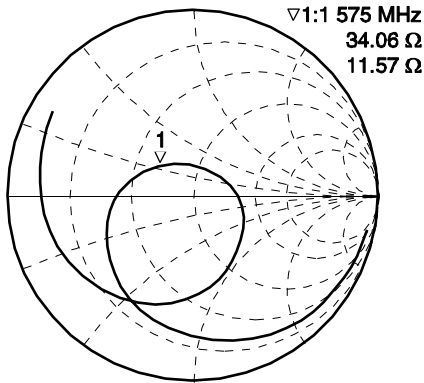

START 100.000 000 MHz STOP 4 000.000 000 MHz

S₂₂-FREQUENCY

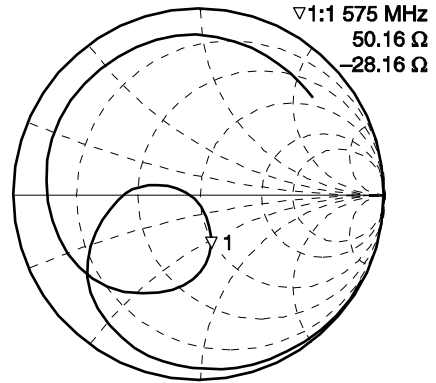

START 100.000 000 MHz STOP 4 000.000 000 MHz

INPUT RETURN LOSS vs. FREQUENCY

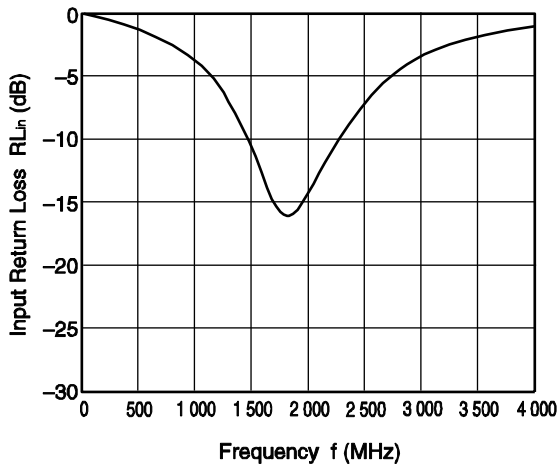

OUTPUT RETURN LOSS vs. FREQUENCY

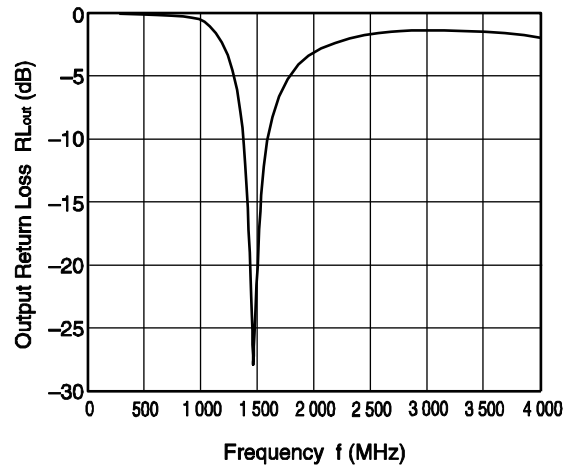

POWER GAIN vs. FREQUENCY

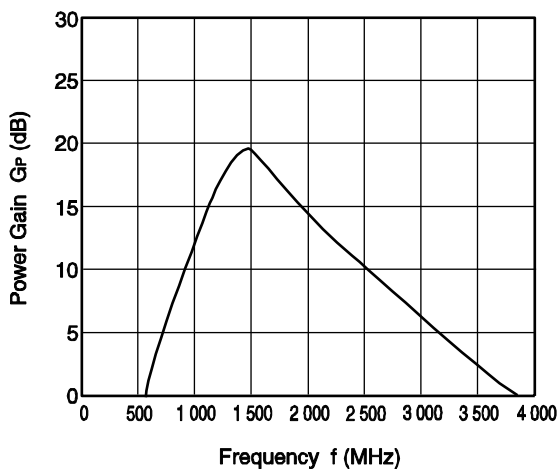

ISOLATION vs. FREQUENCY

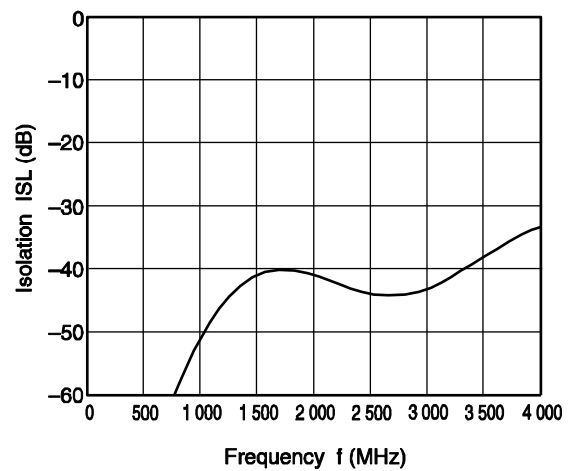

Remark The graphs indicate nominal characteristics.

PACKAGE DIMENSIONS

8-PIN LEAD-LESS MINIMOLD (UNIT: mm)

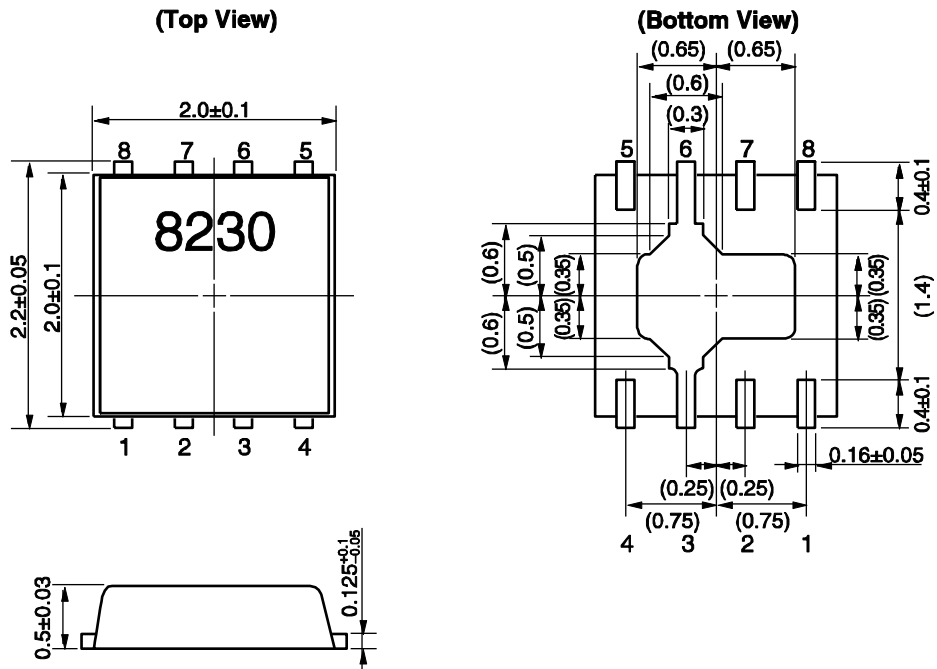

Remark (): Reference value

NOTES ON CORRECT USE

- (1) Observe precautions for handling because of electro-static sensitive devices.
- (2) Form a ground pattern as widely as possible to minimize ground impedance (to prevent undesired oscillation).
All the ground terminals must be connected together with wide ground pattern to decrease impedance difference.
- (3) The bypass capacitor should be attached to Vcc line.
- (4) Do not supply DC voltage to INPUT pin.

RECOMMENDED SOLDERING CONDITIONS

This product should be soldered and mounted under the following recommended conditions. For soldering methods and conditions other than those recommended below, contact your nearby sales office.

Soldering Method	Soldering Conditions	Condition Symbol
Infrared Reflow	Peak temperature (package surface temperature) : 260°C or below Time at peak temperature : 10 seconds or less Time at temperature of 220°C or higher : 60 seconds or less Preheating time at 120 to 180°C : 120±30 seconds Maximum number of reflow processes : 3 times Maximum chlorine content of rosin flux (% mass) : 0.2%(Wt.) or below	IR260
Wave Soldering	Peak temperature (molten solder temperature) : 260°C or below Time at peak temperature : 10 seconds or less Preheating temperature (package surface temperature) : 120°C or below Maximum number of flow processes : 1 time Maximum chlorine content of rosin flux (% mass) : 0.2%(Wt.) or below	WS260
Partial Heating	Peak temperature (terminal temperature) : 350°C or below Soldering time (per side of device) : 3 seconds or less Maximum chlorine content of rosin flux (% mass) : 0.2%(Wt.) or below	HS350

Caution Do not use different soldering methods together (except for partial heating).

Mouser Electronics

Authorized Distributor

Click to View Pricing, Inventory, Delivery & Lifecycle Information:

CEL:

[UPC8230TU-A](#) [UPC8230TU-KB-A](#) [UPC8230TU-KB-E2-A](#)

NEC:

[UPC8182TB](#)