

Chip Multilayer Ceramic Capacitors for General

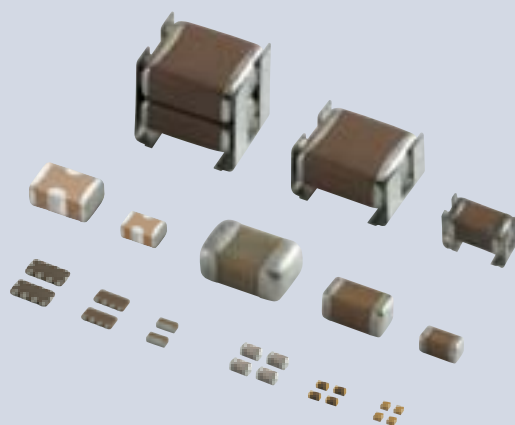

2020

Contents

Product specifications are as of January 2020.

Explanation of Symbols in This Catalog	··· p3	Part Numbering	·········· p6
Selection Guide	·········· p4	Capacitance Table	·········· p10
Catalog information	·········· p5		
		Cap. Table	
<hr/>			
Chip Multilayer Ceramic Capacitors for General Purpose			
GRM Series	·········· p37		p11
High Effective Capacitance & High Ripple Current Chip Multilayer Ceramic Capacitors for General Purpose			
GR3 Series	·········· p59		p25
Soft Termination Chip Multilayer Ceramic Capacitors for General Purpose			
GRJ Series	·········· p61		p25
Chip Multilayer Ceramic Capacitors for Information Devices Only			
GR4 Series	·········· p63		p26
High Q Chip Multilayer Ceramic Capacitors for General Purpose			
GJM Series	·········· p66		p27
High Q and High Power Chip Multilayer Ceramic Capacitors for General Purpose			
GQM Series	·········· p81		p28
Based on the Electrical Appliance and Material Safety Law of Japan Chip Multilayer Ceramic Capacitors for General Purpose			
GA2 Series	·········· p89		p29
Safety Standard Certified Chip Multilayer Ceramic Capacitors for General Purpose / IEC60384-14 Class X2			
GA3 Series Type GB	·········· p91		p29
Safety Standard Certified Chip Multilayer Ceramic Capacitors for General Purpose / Acquired Certifications of UL60950-1			
GA3 Series Type GD	·········· p94		p29
Safety Standard Certified Chip Multilayer Ceramic Capacitors for General Purpose / Acquired Certifications of IEC60384-14 Class X1/Y2 and UL60950-1			
GA3 Series Type GF	p97		p30
LW Reversed Low ESL Chip Multilayer Ceramic Capacitors for General Purpose			
LLL Series	·········· p101		p31
8 Terminals Low ESL Chip Multilayer Ceramic Capacitors for General Purpose			
LLA Series	·········· p103		p31
10 Terminals Low ESL Chip Multilayer Ceramic Capacitors for General Purpose			
LLM Series	·········· p105		p32
LW Reversed Controlled ESR Low ESL Chip Multilayer Ceramic Capacitors for General Purpose			
LLR Series	·········· p107		p32
3 Terminals Low ESL Chip Multilayer Ceramic Capacitors for General Purpose			
NFM Series	·········· p109		p32
Metal Terminal Type Multilayer Ceramic Capacitors for General Purpose			
KRM Series	·········· p112		p32
High Effective Capacitance & High Allowable Ripple Current Metal Terminal Type Multilayer Ceramic Capacitors for General Purpose			
KR3 Series	·········· p116		p34
Wire Bonding Mount Multilayer Microchip Capacitors for General Purpose			
GMA Series	·········· p119		p34
Wire Bonding/AuSn Soldering Mount Chip Multilayer Ceramic Capacitors for General Purpose			
GMD Series	·········· p122		p35
⚠Caution/Notice/Soldering and Mounting	·········· p125		
Introduction of Website	SimSurfing	·········· p151	
Product Information	·········· p152		

Please check the MURATA website (<https://www.murata.com/>) if you cannot find a part number in this catalog.

EU RoHS Compliant

- All the products in this catalog comply with EU RoHS.
- EU RoHS is "the European Directive 2011/65/EU on the Restriction of the Use of Certain Hazardous Substances in Electrical and Electronic Equipment."
- For more details, please refer to our web page, "Murata's Approach for EU RoHS" (<https://www.murata.com/en-eu/support/compliance/rohs>).

Qualified Standards

- The products listed here have been produced by ISO 9001 certified factory.
 <Plant>
 - Fukui Murata Mfg. Co., Ltd.
 - Izumo Murata Mfg. Co., Ltd.
 - Murata Electronics Singapore (Pte.) Ltd.
 - Wuxi Murata Electronics Co., Ltd.
 - PHILIPPINE MANUFACTURING CO. OF MURATA, INC.

GRM
 GR3
 GRJ
 GR4
 GJM
 GQM
 GA2
 GA3 GB
 GA3 GD
 GA3 GF
 LLL
 LLA
 LLM
 LLR
 NFM
 KRM
 KR3
 GMA
 GMD
 ⚠Caution/Notice
 2

Explanation of Symbols in This Catalog



Links are provided to the latest information from the PDF version of the catalog, which is available on the web.

General	For applications that do not require the particular reliability such as the general equipment
Info-tainment	Infotainment for Automotive The product for entertainment equipment like car navigations, car audios, and body control equipment like wipers, power windows.
Power-train	Powertrain/Safety for Automotive Product used for applications (running, turning, stopping and safety devices) which particularly concern human life, such as in devices for automobiles.
Medical Device	Medical-grade products for Implanted Medical Devices These products are intended for use in implanted medical devices such as cardiac pacemakers, cochlear implants, insulin pumps and gastric electrostimulators. They are suitable for use in non-critical circuits. *1 *1 Non-critical circuits This term refers to circuits in implanted medical devices that are not directly linked to life support, i.e. circuits that will not directly endanger the life of the patient should the functionality of the device be reduced or halted by failure of the circuit.
AEC-Q200	AEC-Q200 compliant product
Safety standard	Safety Standard Certified Product Products that acquired safety standard certification IEC60384-14 and products based on the Electrical Appliance and Material Safety Law of Japan.
Japanese Safety Law	Based on the Electrical Appliance and Material Safety Law of Japan Products that are based on the electrical appliance and material safety law of Japan.
High Q	Low dissipation for high frequency By devising ceramic materials and electrode materials, low dissipation is achieved in frequency bands of VHF, UHF and microwave or beyond.
Low ESL	Low inductance This capacitor is designed so that the parasitic inductance component (ESL) that the capacitor has on the high frequency side becomes lower.
Deflecting crack	Product resistant to deflection cracking This capacitor is designed to prevent failures as much as possible by short mode caused by cracking when there is board deflection.
Soldering crack	Product with solder cracking suppression "This capacitor is configured with metal terminals and leads connected to the chip. The metal terminals and leads relieve the stress from expansion and contraction of the solder, to suppress solder cracking."
Anti-noise	Product suitable for acoustic noise reduction and low distortion This product suppresses acoustic noise, which occurs when a ceramic capacitor is used, by devising the materials and configuration.
Effective Cap	No DC bias characteristics Polymer capacitor is no capacitance change with DC bias due to aluminum oxidized film for dielectric.
EMI Filter	Low-inductance product suitable for noise suppression. This product has extremely low ESL and is suitable for suppression of noise, including high frequencies. This product can also be used as a low-ESL, high-performance bypass capacitor.
Bonding	Product for bonding Since gold is used for the external electrodes, the capacitor can be mounted by die bonding/wire bonding.

D1 Derating 1	<p>Derating 1 Murata's General MLCC products are designed for use in devices with a typical lifetime around 10 years. Murata's general MLCC products are designed so that the useful lifetime can be extended longer than 10 years under the following conditions: "80% of the rated voltage or less, Maximum operating temperature -20 degree C or less" Extended useful lifetime, under specific operating conditions, can be estimated from the chart. • The useful lifetime is the time when cumulative failure rate becomes 1%. • Please note that the useful lifetime data is for reference only and not guaranteed.</p>
D2 Derating 2	<p>Derating 2 When the product temperature exceeds 105°C, please use this product within the voltage and temperature derated conditions in the figure below.</p>
D3 Derating 3	<p>Derating 3 Please apply the derating curve according to the operating temperature. Please refer to detailed specifications sheet for details.</p>
D4 Derating 4	<p>Derating 4 When the product temperature exceeds 125°C, please use this product within the voltage and temperature derated conditions in the figure below.</p>
D5 Derating 5	<p>Derating 5 Please apply the rated voltage derating over 150 °C. Please refer to detailed specifications sheet for details.</p>

Selection Guide for Ceramic Capacitors

For general			
General SMD			
Solder mounting			
Chip type			
	GRM		p37
	GR3	Anti-noise	High effective capacitance & high ripple current p59
	GRJ	Deflecting crack	Soft termination p61
	GR4		For information devices only p63
	GJM	High Q	p66
	GQM	High Q	High power p81
	GA2	Japanese Safety Law	Based on the Electrical Appliance and Material Safety Law of Japan p89
	GA3	Safety standard	p91
	LLL	Low ESL	LW reversed p101
	LLA	Low ESL	8 terminals p103
	LLM	Low ESL	10 terminals p105
	LLR	Low ESL	LW reversed controlled ESR p107
	NFM	Low ESL EMI Filter	3 terminals p109
	GJ4	Anti-noise	Low distortion WEB
On interposer board			
	ZRA	Anti-noise	WEB
	ZRB	Anti-noise	WEB
Metal terminal type			
	KRM	Anti-noise Deflecting crack Soldering crack	p112
	KR3	Anti-noise Deflecting crack Soldering crack	High effective capacitance & high ripple current p116
Resin molding SMD type			
	DK1	Safety standard	WEB
Wire bonding mounting			
Bonding Chip type			
	GMA		Microchip p119
	GMD		p122
Lead type			
Solder mounting			
	RDE	Anti-noise Deflecting crack Soldering crack	WEB
	DE1	Safety standard	X1/Y1 Class certified product WEB
	DE2	Safety standard	X1/Y2 Class certified product WEB

Infotainment for automotive		
SMD		
Solder mounting		
Chip type		
	GRT	WEB

Powertrain/Safety for automotive			
SMD			
Solder mounting			
Chip type			
	GCM	WEB	
	GC3	Anti-noise	High effective capacitance & high ripple current WEB
	GCJ	Deflecting crack	Soft termination WEB
	GCQ	High Q	WEB
	GCD	Deflecting crack	MLSC design WEB
	GCE	Deflecting crack	Soft termination MLSC design WEB
	NFM	Low ESL EMI Filter	3 terminals WEB
Metal terminal type			
	KCM	Anti-noise Deflecting crack Soldering crack	WEB
	KC3	Anti-noise Deflecting crack Soldering crack	High effective capacitance & high ripple current WEB
	KCA	Safety standard Anti-noise Deflecting crack Soldering crack	WEB
Limited to Conductive Glue Mounting			
Chip type			
	GCB	Deflecting crack Soldering crack	Ni plating + Pd plating termination conductive glue mounting WEB
	GCG	Deflecting crack Soldering crack	AgPd termination conductive glue mounting WEB
Lead type			
Solder mounting			
	RCE	Anti-noise Deflecting crack Soldering crack	WEB
	RHE	Anti-noise Deflecting crack Soldering crack	150°C operation leaded WEB
	RHS	Anti-noise Deflecting crack Soldering crack	200°C operation leaded WEB
	DE6	Safety standard	WEB

Medical-grade products for implanted medical devices		
SMD		
Solder mounting		
Chip type		
	GCH	WEB

Catalog Information

Catalog relates to a multilayer ceramic capacitor is below.

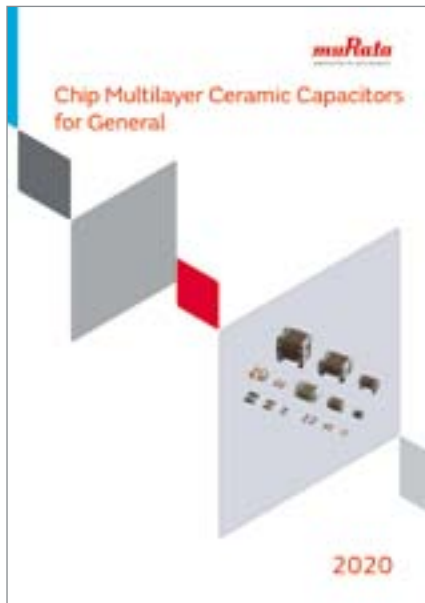

Chip Multilayer Ceramic Capacitors for General

Cat No. C02E-22

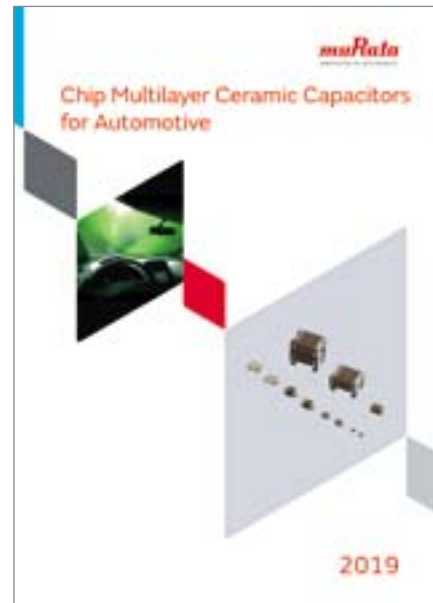

Chip Multilayer Ceramic Capacitors for Automotive

Cat No. C03E-10



**Lead Type Disc Ceramic Capacitors (Safety Standard Certified)
Resin Molding SMD Type Ceramic Capacitors (Safety Standard Certified)**

Cat No. C85E-7



Leaded MLCC

Cat No. C49E-25

● Part Numbering

Chip Multilayer Ceramic Capacitors for General



(Part Number)

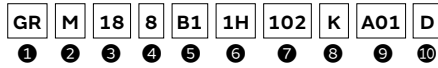

① Product ID ② Series

Product ID	Code	Series
GA	2	Based on the Electrical Appliance and Material Safety Law of Japan Chip Multilayer Ceramic Capacitors for General Purpose
	3	Safety Standard Certified Chip Multilayer Ceramic Capacitors for General Purpose
GJ	M	High Q Chip Multilayer Ceramic Capacitors for General Purpose
GM	A	Wire Bonding Mount Multilayer Microchip Capacitors for General Purpose
	D	Wire Bonding/AuSn Soldering Mount Chip Multilayer Ceramic Capacitors for General Purpose
GQ	M	High Q and High Power Chip Multilayer Ceramic Capacitors for General Purpose
GR	3	High Effective Capacitance & High Ripple Current Chip Multilayer Ceramic Capacitors for General Purpose
	4	Chip Multilayer Ceramic Capacitors for Information Devices only
	J	Soft Termination Chip Multilayer Ceramic Capacitors for General Purpose
	M	Chip Multilayer Ceramic Capacitors for General Purpose
KR	3	High Effective Capacitance & High Allowable Ripple Current Metal Terminal Type Multilayer Ceramic Capacitors for General Purpose
	M	Metal Terminal Type Multilayer Ceramic Capacitors for General Purpose
LL	A	8 Terminals Low ESL Chip Multilayer Ceramic Capacitors for General Purpose
	L	LW Reversed Low ESL Chip Multilayer Ceramic Capacitors for General Purpose
	M	10 Terminals Low ESL Chip Multilayer Ceramic Capacitors for General Purpose
	R	LW Reversed Controlled ESR Low ESL Chip Multilayer Ceramic Capacitors for General Purpose

③ Chip Dimensions (LxW)

Code	Dimensions (LxW)	EIA
01	0.25x0.125mm	008004
02	0.4x0.2mm	01005
0D	0.38x0.38mm	015015
03	0.6x0.3mm	0201
05	0.5x0.5mm	0202
08	0.8x0.8mm	0303
1U	0.6x1.0mm	02404
15	1.0x0.5mm	0402
18	1.6x0.8mm	0603
21	2.0x1.25mm	0805
22	2.8x2.8mm	1111
31	3.2x1.6mm	1206
32	3.2x2.5mm	1210
42	4.5x2.0mm	1808
43	4.5x3.2mm	1812
52	5.7x2.8mm	2211
55	5.7x5.0mm	2220

Continued on the following page. ↗

(Part Number)

GR	M	18	8	B1	1H	102	K	A01	D
①	②	③	④	⑤	⑥	⑦	⑧	⑨	⑩

Continued from the preceding page. ↘

④ Height Dimension (T) (Except KR□)

Code	Dimension (T)
1	0.125mm
2	0.2mm
3	0.3mm
4	0.4mm
5	0.5mm
6	0.6mm
7	0.7mm
8	0.8mm
9	0.85mm
A	1.0mm
B	1.25mm
C	1.6mm
D	2.0mm
E	2.5mm
M	1.15mm
Q	1.5mm
X	Depends on individual standards.

④ Height Dimension (T) (KR□ Only)

Code	Dimension (T)
E	1.8mm
F	1.9mm
K	2.7mm
L	2.8mm
R	3.6mm
Q	3.7mm
T	4.8mm
V	6.2mm
W	6.4mm

⑤ Temperature Characteristics

Temperature Characteristic Codes		Temperature Characteristics				Operating Temperature Range	Capacitance Change Each Temperature (%)					
Code	Public STD Code	Reference Temperature	Temperature Range	Capacitance Change or Temperature Coefficient	-55°C		*4		-10°C			
					Max.		Min.	Max.	Min.	Max.	Min.	
1X	SL	JIS	20°C	20 to 85°C	+350 to -1000ppm/°C	-55 to 125°C	-	-	-	-	-	-
2C	CH	JIS	20°C	20 to 125°C	0±60ppm/°C	-55 to 125°C	0.82	-0.45	0.49	-0.27	0.33	-0.18
3C	CJ	JIS	20°C	20 to 125°C	0±120ppm/°C	-55 to 125°C	1.37	-0.9	0.82	-0.54	0.55	-0.36
3U	UJ	JIS	20°C	20 to 85°C	-750±120ppm/°C	-25 to 85°C	-	-	4.94	2.84	3.29	1.89
4C	CK	JIS	20°C	20 to 125°C	0±250ppm/°C	-55 to 125°C	2.56	-1.88	1.54	-1.13	1.02	-0.75
5C	C0G	EIA	25°C	25 to 125°C	0±30ppm/°C	-55 to 125°C	0.58	-0.24	0.4	-0.17	0.25	-0.11
5G	X8G	*2	25°C	25 to 150°C	0±30ppm/°C	-55 to 150°C	0.58	-0.24	0.4	-0.17	0.25	-0.11
7U	U2J	EIA	25°C	25 to 125°C *3	-750±120ppm/°C	-55 to 125°C	8.78	5.04	6.04	3.47	3.84	2.21
B1	B *1	JIS	20°C	-25 to 85°C	±10%	-25 to 85°C	-	-	-	-	-	-
B3	B	JIS	20°C	-25 to 85°C	±10%	-25 to 85°C	-	-	-	-	-	-
C7	X7S	EIA	25°C	-55 to 125°C	±22%	-55 to 125°C	-	-	-	-	-	-
C8	X6S	EIA	25°C	-55 to 105°C	±22%	-55 to 105°C	-	-	-	-	-	-
D7	X7T	EIA	25°C	-55 to 125°C	+22%, -33%	-55 to 125°C	-	-	-	-	-	-
D8	X6T	EIA	25°C	-55 to 105°C	+22%, -33%	-55 to 105°C	-	-	-	-	-	-
E7	X7U	EIA	25°C	-55 to 125°C	+22%, -56%	-55 to 125°C	-	-	-	-	-	-
R1	R *1	JIS	20°C	-55 to 125°C	±15%	-55 to 125°C	-	-	-	-	-	-
R6	X5R	EIA	25°C	-55 to 85°C	±15%	-55 to 85°C	-	-	-	-	-	-
R7	X7R	EIA	25°C	-55 to 125°C	±15%	-55 to 125°C	-	-	-	-	-	-

*1 Capacitance change is specified with 50% rated voltage applied.

*2 Murata Temperature Characteristic Code.

*3 Rated Voltage 100Vdc max: 25 to 85°C

*4 -25°C (Reference Temperature 20°C) / -30°C (Reference Temperature 25°C)

Continued on the following page. ↗

(Part Number)

GR	M	18	8	B1	1H	102	K	A01	D
1	2	3	4	5	6	7	8	9	10

Continued from the preceding page. ↘

⑥ Rated Voltage

Code	Rated Voltage
OE	DC2.5V
OG	DC4V
OJ	DC6.3V
1A	DC10V
1C	DC16V
1E	DC25V
1H	DC50V
1J	DC63V
2A	DC100V
2D	DC200V
2E	DC250V
2W	DC450V
2H	DC500V
2J	DC630V
3A	DC1kV
3D	DC2kV
3F	DC3.15kV
E2	AC250V
GB	X2; AC250V (Safety Standard Certified Type GB)
GD	Y3; AC250V (Safety Standard Certified Type GD)
GF	Y2, X1/Y2; AC250V (Safety Standard Certified Type GF)
YA	DC35V

⑦ Capacitance

Expressed by three-digit alphanumerics. The unit is picofarad (pF). The first and second figures are significant digits, and the third figure expresses the number of zeros which follow the two numbers. If there is a decimal point, it is expressed by the capital letter "R." In this case, all figures are significant digits. If any alphabet, other than "R", is included, this indicates the specific part number is a non-standard part.

Ex.)

Code	Capacitance
R50	0.50pF
1R0	1.0pF
100	10pF
103	10000pF

⑧ Capacitance Tolerance

Code	Capacitance Tolerance
B	±0.1pF
C	±0.25pF
D	±0.5pF (Less than 10pF) ±0.5% (10pF and over)
F	±1%
G	±2%
J	±5%
K	±10%
M	±20%
W	±0.05pF

⑨ Individual Specification Code (Except LLR)

Expressed by three figures.

⑨ ESR (LLR Only)

Code	ESR
E01	100mΩ
E03	220mΩ
E05	470mΩ
E07	1000mΩ

⑩ Packaging

Code	Packaging
L	ø180mm Embossed Taping
D/E/W	ø180mm Paper Taping
K	ø330mm Embossed Taping
J/F	ø330mm Paper Taping
T	Bulk Tray

Please contact us if you find any part number not provided in this table.

3 Terminal Low ESL Multilayer Ceramic Capacitors



(Part Number)

NF	M	3D	CC	102	R	1H	3	L
①	②	③	④	⑤	⑥	⑦	⑧	⑨

① Product ID ② Series

Product ID	Series
NFM	3 Terminals Low ESL Chip Multilayer Ceramic Capacitors

③ Dimensions (LxW)

Code	Dimensions (LxW)	EIA
15	1.0x0.5mm	0402
18	1.6x0.8mm	0603
21	2.0x1.25mm	0805
3D	3.2x1.25mm	1205
31	3.2x1.6mm	1206
41	4.5x1.6mm	1806

④ Features

Code	Features	
CC	For General	For Signal Lines
PC		For Large Current
PS		High Insertion Loss Type for Large Current
KC		For Very Large Current

⑤ Capacitance

Expressed by three figures. The unit is in pico-farad (pF). The first and second figures are significant digits, and the third figure expresses the number of zeros that follow the two figures.

⑥ Characteristics

Code	Capacitance Temperature Characteristics
B	±10%, ±12.5%, +10/-13%
C	±22%
D	+22/-33%
R	±15%, +15/-18%

⑦ Rated Voltage

Code	Rated Voltage
0E	2.5V
0G	4V
0J	6.3V
1A	10V
1C	16V
1E	25V
1H	50V
2A	100V

⑧ Electrode

Code	Electrode
3	Sn Plating

⑨ Packaging

Code	Packaging
B	Bulk
L	Embossed Taping (ø180mm Reel)
D	Paper Taping (ø180mm Reel)

Capacitance Table

How to read the Capacitance Table

L×W (mm)	0.25×0.125		0.2	
T max. (mm)	0.138		0.1	
Rated Voltage (Vdc)	25	16	50	
Cap. / TC Code	C0G	C0G	C0G	CΔ
0.10pF				
0.20pF	p37	p38	p38	p39
2.0pF	p37	p38	p38	p39
2.1pF	p37	p38	p38	p39
2.3pF	p37	p38	p38	p39

→ The values can be narrowed down in the order of size, rated voltage, and temperature characteristics.

→ Refers to the page of the part number list.
 Check the part number list for the applicable product number.

Temperature Characteristics Table

The Table is colored by temperature characteristic codes.
 Refer to the following Table for the meaning of each code.

EIA:	C0G	U2J	X7R	X7S	X7T	X7U	X6S	X6T	X5R
JIS:	CK	CJ	CH	SL	UJ	R	B		
Murata Temperature Characteristic:	X8G								

Temperature Characteristic Codes		Temperature Characteristics			Operating Temperature Range	Capacitance Change Each Temperature (%)					
Public STD Code	Reference Temperature	Temperature Range	Capacitance Change or Temperature Coefficient	-55°C		*3		-10°C			
				Max.		Min.	Max.	Min.	Max.	Min.	
C0G	EIA	25°C	25 to 125°C	0±30ppm/°C	-55 to 125°C	0.58	-0.24	0.4	-0.17	0.25	-0.11
CK	JIS	20°C	20 to 125°C	0±250ppm/°C	-55 to 125°C	2.56	-1.88	1.54	-1.13	1.02	-0.75
CJ	JIS	20°C	20 to 125°C	0±120ppm/°C	-55 to 125°C	1.37	-0.9	0.82	-0.54	0.55	-0.36
CH	JIS	20°C	20 to 125°C	0±60ppm/°C	-55 to 125°C	0.82	-0.45	0.49	-0.27	0.33	-0.18
SL	JIS	20°C	20 to 85°C	+350 to -1000ppm/°C	-55 to 125°C	-	-	-	-	-	-
U2J	EIA	25°C	25 to 125°C *2	-750±120ppm/°C	-55 to 125°C	8.78	5.04	6.04	3.47	3.84	2.21
UJ	JIS	20°C	20 to 85°C	-750±120ppm/°C	-25 to 85°C	-	-	4.94	2.84	3.29	1.89
X8G	*1	25°C	25 to 150°C	0±30ppm/°C	-55 to 150°C	0.58	-0.24	0.4	-0.17	0.25	-0.11
X7R	EIA	25°C	-55 to 125°C	±15%	-55 to 125°C	-	-	-	-	-	-
X7S	EIA	25°C	-55 to 125°C	±22%	-55 to 125°C	-	-	-	-	-	-
X7T	EIA	25°C	-55 to 125°C	+22%, -33%	-55 to 125°C	-	-	-	-	-	-
X7U	EIA	25°C	-55 to 125°C	+22%, -56%	-55 to 125°C	-	-	-	-	-	-
R	JIS	20°C	-55 to 125°C	±15%	-55 to 125°C	-	-	-	-	-	-
X6S	EIA	25°C	-55 to 105°C	±22%	-55 to 105°C	-	-	-	-	-	-
X6T	EIA	25°C	-55 to 105°C	+22%, -33%	-55 to 105°C	-	-	-	-	-	-
X5R	EIA	25°C	-55 to 85°C	±15%	-55 to 85°C	-	-	-	-	-	-
B	JIS	20°C	-25 to 85°C	±10%	-25 to 85°C	-	-	-	-	-	-

*1 Murata Temperature Characteristic Code.

*2 Rated Voltage 100Vdc max: 25 to 85°C

*3 -25°C (Reference Temperature 20°C) / -30°C (Reference Temperature 25°C)

Capacitance Table

(→ GRM Series Temperature Compensating Type)

p00 ← Part Number List JIS: **CK** **CJ** **CH** **UJ** EIA: **COG** **U2J**

L×W (mm)	1.6×0.8								2.0×1.25							
	0.9		1.0		0.65		0.7		0.95		1.0		1.35			
T max. (mm)	250	100	50	10	100	50	100	50	100	50	10	630	250	200	100	
Rated Voltage (Vdc)	COG	COG	CH	COG	CH	U2J	UJ	COG	COG	COG	CH	COG	CH	U2J	UJ	
Cap. / TC Code	COG	COG	CH	COG	CH	U2J	UJ	COG	COG	COG	CH	COG	CH	U2J	UJ	
0.10pF																
0.20pF																
2.0pF																
2.1pF																
2.3pF																
2.4pF																
3.9pF																
4.0pF																
10pF	p47											p48	p48	p48		
11pF																
12pF																
13pF																
15pF	p47											p48	p48	p48		
16pF																
18pF																
20pF																
22pF	p47											p48	p48	p48		
24pF																
27pF																
30pF																
33pF	p47											p48	p48	p48		
36pF																
39pF																
43pF																
47pF	p47											p48	p48	p48		
51pF																
56pF																
62pF																
68pF												p48	p48	p48		
75pF																
82pF																
91pF																
100pF												p48	p48	p48	p48	
120pF												p48	p48	p48	p48	
150pF												p48	p48	p48	p48	
180pF												p48	p48	p48	p48	
220pF												p48	p48	p48	p48	
270pF												p48	p48	p48	p48	
330pF												p48	p48	p48	p48	
390pF												p48	p48	p48	p48	
470pF												p48	p48	p48	p48	
560pF																
680pF												p48	p48	p48	p48	
820pF																
910pF																
1000pF	p47	p47	p47	p47				p47	p48				p48	p48	p48	
1200pF	p47	p47	p47	p47				p47	p48							
1500pF	p47	p47	p47	p47				p47	p48				p48	p48	p48	
1800pF	p47	p47	p47	p47				p47	p48							
2200pF	p47	p47	p47	p47				p47	p48				p48	p48	p48	
2700pF	p47	p47	p47	p47				p47	p48	p48	p48					
3300pF	p47	p47	p47	p47				p47	p48	p48	p48					
3900pF	p47	p47	p47	p47				p47	p48	p48	p48					
4700pF			p47	p47				p47	p48	p48	p48					
5600pF			p47	p47						p48	p48	p48	p48			
6800pF			p47	p47				p47		p48	p48	p48	p48			
8200pF			p47	p47				p47		p48	p48	p48	p48			
10000pF			p47	p47				p47		p48	p48	p48	p48			
12000pF					p47	p47	p47					p48	p48	p48	p48	
15000pF					p47	p47	p47					p48	p48	p48	p48	
18000pF					p47	p47		p47								
22000pF					p47	p47		p47								
27000pF								p47								
33000pF								p47								
39000pF																
47000pF																
56000pF												p48	p48			
68000pF																
82000pF																
0.10μF																
0.15μF																
0.22μF																

Continued on the following page. ↗

Capacitance Table

(→ GRM Series Temperature Compensating Type)

p00 ← Part Number List JIS: **CK** **CJ** **CH** **UJ** EIA: **COG** **U2J**

L×W (mm)	3.2×1.6																3.2×2.5								
	1.25				1.8				1.0								1.25		1.5						
	500	250	200	100	50				1000	630	500	250	100	50	2000	630	500	2000	1000	630	500				
Rated Voltage (Vdc)	U2J	U2J	U2J	COG	CH	COG	CH	U2J	UJ	COG	U2J	COG	U2J	U2J	COG	CH	COG	CH	U2J	U2J	U2J	U2J	U2J	U2J	U2J
Cap. / TC Code	U2J	U2J	U2J	COG	CH	COG	CH	U2J	UJ	COG	U2J	COG	U2J	U2J	COG	CH	COG	CH	U2J	U2J	U2J	U2J	U2J	U2J	U2J
0.10pF																									
0.20pF																									
2.0pF																									
2.1pF																									
2.3pF																									
2.4pF																									
3.9pF																									
4.0pF																									
10pF																									
11pF																									
12pF																									
13pF																									
15pF																									
16pF																									
18pF																									
20pF																									
22pF																									
24pF																									
27pF																									
30pF																									
33pF																									
36pF																									
39pF																									
43pF																									
47pF																									
51pF																									
56pF																									
62pF																									
68pF																									
75pF																									
82pF																									
91pF																									
100pF																									
120pF																									
150pF																									
180pF																									
220pF																									
270pF																									
330pF																									
390pF																									
470pF																									
560pF																									
680pF																									
820pF																									
910pF																									
1000pF																									
1200pF																									
1500pF																									
1800pF																									
2200pF																									
2700pF																									
3300pF	p50																								
3900pF																									
4700pF																									
5600pF																									
6800pF		p50	p50																						
8200pF																									
10000pF		p50	p50																						
12000pF																									
15000pF																									
18000pF																									
22000pF																									
27000pF																									
33000pF																									
39000pF																									
47000pF																									
56000pF																									
68000pF																									
82000pF																									
0.10μF																									
0.15μF																									
0.22μF																									

Continued on the following page. ↗

Capacitance Table

(→ GRM Series Temperature Compensating Type)

p00 ← Part Number List JIS: **CK** **CJ** **CH** **UJ** EIA: **C0G** **U2J**

L×W (mm)	3.2×2.5			4.5×2.0	4.5×3.2			5.7×5.0					
	2.0		2.7	1.0	1.5	2.0		1.5	2.0				
Rated Voltage (Vdc)	1000	630	500	630	3150	1000	1000	630	500	1000	1000	630	500
Cap. / TC Code	U2J	U2J	U2J	U2J	U2J	U2J	U2J	U2J	U2J	U2J	U2J	U2J	U2J
0.10pF													
0.20pF													
2.0pF													
2.1pF													
2.3pF													
2.4pF													
3.9pF													
4.0pF													
10pF					p51								
11pF													
12pF													
13pF													
15pF					p51								
16pF													
18pF													
20pF													
22pF					p51								
24pF													
27pF													
30pF													
33pF					p51								
36pF													
39pF													
43pF													
47pF					p51								
51pF													
56pF													
62pF													
68pF					p51								
75pF													
82pF													
91pF													
100pF					p51								
120pF													
150pF													
180pF													
220pF													
270pF													
330pF													
390pF													
470pF													
560pF													
680pF													
820pF													
910pF													
1000pF													
1200pF													
1500pF													
1800pF													
2200pF	p50												
2700pF													
3300pF					p51								
3900pF													
4700pF						p51							
5600pF													
6800pF									p51				
8200pF													
10000pF	p50	p50								p51			
12000pF													
15000pF				p50			p51	p51					
18000pF													
22000pF							p51	p51					
27000pF													
33000pF										p51	p51		
39000pF													
47000pF										p51	p51		
56000pF													
68000pF													
82000pF													
0.10μF													
0.15μF													
0.22μF													

Capacitance Table

GRM Series High Dielectric Constant Type

p00 ← Part Number List JIS: R B EIA: X7R X7S X7T X7U X6S X6T X5R

L×W (mm)	0.25×0.125						0.4×0.2						0.6×0.3													
	0.138		0.22						0.25			0.33														
T max. (mm)	10	6.3	16			10			6.3	4	2.5	4	2.5	50		35	25			16						
Rated Voltage (Vdc)	10	6.3	16	10	6.3	4	2.5	4	2.5	50	35	25	16													
Cap. / TC Code	X5R	X5R	X7R	X5R	X7R	X5R	B	X5R	B	X6T	X5R	X6T	X6T	X7T	X6T	X7R	X5R	B	X5R	X7R	R	X6S	X5R	B	X7Δ	R
100pF	p52		p52		p52	p52	p52								p53		p53			p53						
150pF			p52		p52	p52	p52								p53		p53			p53						
220pF	p52		p52		p52	p52	p52								p53		p53			p53						
330pF			p52		p52	p52	p52								p53		p53			p53						
470pF	p52		p52		p52	p52	p52								p53	p53	p53			p53						
680pF					p52	p52	p52								p53		p53			p53						
820pF					p52																					
1000pF	p52	p52	p52	p52	p52	p52	p52	p53	p53						p53		p53			p53	p53			p54		
1500pF	p52				p52	p52	p53	p53							p53		p53			p53	p53			p54		
2200pF	p52		p52		p52	p52	p53	p53												p53				p54	p54	p54
3300pF	p52				p52	p52	p53	p53												p53				p54	p54	p54
4700pF	p52		p52		p52	p52	p53	p53												p53			p53		p54	
6800pF	p52				p52	p52	p53	p53												p53			p53		p54	
10000pF	p52		p52		p52	p52	p53	p53												p53			p53	p54	p54	
15000pF								p53				p53														
22000pF								p53				p53														
33000pF								p53				p53														
47000pF								p53				p53														
68000pF								p53				p53														
0.10μF								p53		p53	p53	p53							p53			p53	p53		p54	
0.15μF																										
0.22μF																								p53		
0.33μF																										
0.47μF													p53	p53	p53											
0.68μF																										
1.0μF																										
2.2μF																										
4.7μF																										
10μF																										
22μF																										
47μF																										
100μF																										
220μF																										

Continued on the following page. ↗

Capacitance Table

(→ GRM Series High Dielectric Constant Type)

p00 ← Part Number List JIS: R B EIA: X7R X7S X7T X7U X6S X6T X5R

L×W (mm)	0.6×0.3												1.0×0.5													
	0.33												0.39				0.22		0.33							
T max. (mm)	0.33												0.39				0.22		0.33							
Rated Voltage (Vdc)	16			10				6.3			4		10	6.3	4	2.5	6.3	4	10		6.3		4			
Cap. / TC Code	X6S	X5R	B	X7Δ	R	X5R	B	X7R	R	X6S	X5R	B	X6S	X5R	X7T	X7T	X7T	X5R	X6T	X5R	X5R	B	X6T	X5R	B	X6T
100pF																										
150pF																										
220pF																										
330pF																										
470pF																										
680pF																										
820pF																										
1000pF																										
1500pF																										
2200pF			p54																							
3300pF			p54																							
4700pF				p54	p54	p54	p54	p54	p54																p55	
6800pF				p54	p54	p54	p54	p54	p54																p55	
10000pF		p54	p54	p54	p54					p54	p54															
15000pF		p54	p54			p54	p54						p55												p55	
22000pF		p54	p54			p54	p54						p55												p55	
33000pF		p54	p54			p54	p54						p55												p55	
47000pF		p54	p54			p54	p54						p55													
68000pF		p54	p54			p54	p54						p55													
0.10μF	p54	p54	p54	p54		p54	p54						p55													
0.15μF																										
0.22μF		p54				p54							p55	p55											p55	
0.33μF																										
0.47μF																										
0.68μF																										
1.0μF																		p55	p55	p55	p55	p55	p55	p55	p55	p55
2.2μF																										
4.7μF																										
10μF																										
22μF																										
47μF																										
100μF																										
220μF																										

Continued on the following page. ↗

Capacitance Table

(→ GRM Series High Dielectric Constant Type)

p00 ← Part Number List JIS: R B EIA: X7R X7S X7T X7U X6S X6T X5R

L×W (mm)	1.0×0.5																										
	0.55																		0.6								
T max. (mm)	0.55																		0.6								
Rated Voltage (Vdc)	100	50				35	25			16			10			6.3			4	50	35	25	16	6.3	4		
Cap. / TC Code	X7R	X7R	R	X5R	B	X6S	X7R	X5R	B	X7R	X5R	B	X7R	X6S	B	X7R	X6S	B	X7R	X5R	X5R	X6S	X6S	X5R	B	X5R	
100pF																											
150pF																											
220pF	p55																										
330pF																											
470pF	p55																										
680pF																											
820pF																											
1000pF	p55																										
1500pF																											
2200pF	p55	p55	p55																								
3300pF																											
4700pF	p55	p55	p55																								
6800pF																											
10000pF		p55	p55																								
15000pF																											
22000pF		p55								p55																	
33000pF																											
47000pF		p55								p55																	
68000pF																											
0.10μF		p55		p55	p55					p55																	
0.15μF																											
0.22μF						p55				p55				p55													
0.33μF																											
0.47μF														p55								p55					
0.68μF																											
1.0μF								p55	p55		p55	p55		p55		p55					p55				p55	p55	p55
2.2μF																p55		p55	p55								
4.7μF																											
10μF																											
22μF																											
47μF																											
100μF																											
220μF																											

Continued on the following page. ↗

Capacitance Table

(→ GRM Series High Dielectric Constant Type)

p00 ← Part Number List JIS: R B EIA: X7R X7S X7T X7U X6S X6T X5R

L×W (mm)	1.0×0.5												1.6×0.8												
	0.6		0.65				0.7						0.5		0.55		0.9								
T max. (mm)	4	2.5	25	16	10	6.3	25	16	10	6.3	4	2.5	6.3	4	16	10	6.3	25	16						
Rated Voltage (Vdc)	4	2.5	25	16	10	6.3	25	16	10	6.3	4	2.5	6.3	4	16	10	6.3	25	16						
Cap. / TC Code	B	X6T	X6T	X7T	X6T	X7T	X5R	X6S	X5R	X6S	X5R	X7S	X6S	X7S	X5R	X5R	X5R	X5R	X6S	X7T	X6S	X5R	B	X6S	
100pF																									
150pF																									
220pF																									
330pF																									
470pF																									
680pF																									
820pF																									
1000pF																									
1500pF																									
2200pF																									
3300pF																									
4700pF																									
6800pF																									
10000pF																									
15000pF																									
22000pF																									
33000pF																									
47000pF																									
68000pF																									
0.10μF																									
0.15μF																									
0.22μF																									
0.33μF																									
0.47μF																									
0.68μF																									
1.0μF																									
2.2μF			p55	p55	p55	p56			p56	p56	p56	p56	p56	p56									p56	p56	p56
4.7μF	p55	p55					p56	p56																	
10μF														p56	p56	p56	p56	p56							
22μF																									
47μF																									
100μF																									
220μF																									

Continued on the following page. ↗

Capacitance Table

(→ GRM Series High Dielectric Constant Type)

p00 ← Part Number List JIS: R B EIA: X7R X7S X7T X7U X6S X6T X5R

L×W (mm)	1.6×0.8																											
	0.9			0.95						1.0																		
T max. (mm)	0.9			0.95						1.0																		
Rated Voltage (Vdc)	10	6.3	4	25	16		10		50	35	25		16	10	6.3		4											
Cap. / TC Code	X7R	X5R	B	X5R	X5R	X6S	X5R	B	X7S	X5R	B	X5R	X6S	X5R	X7S	X6S	X5R	X7S	X6S	X7T	X7T	X5R	B	X6S	X5R	B		
100pF																												
150pF																												
220pF																												
330pF																												
470pF																												
680pF																												
820pF																												
1000pF																												
1500pF																												
2200pF																												
3300pF																												
4700pF																												
6800pF																												
10000pF																												
15000pF																												
22000pF																												
33000pF																												
47000pF																												
68000pF																												
0.10μF																												
0.15μF																												
0.22μF																												
0.33μF																												
0.47μF																												
0.68μF																												
1.0μF																												
2.2μF	p56											p56	p56		p56	p56		p56										
4.7μF				p56	p56	p56	p56	p56					p56		p56		p56											
10μF		p56	p56	p56			p56			p56	p56						p56		p56	p56	p56							
22μF																						p56	p56	p56	p56	p56		
47μF																												
100μF																												
220μF																												

Continued on the following page. ↗

Capacitance Table

(→ GRM Series High Dielectric Constant Type)

p00 ← Part Number List JIS: R B EIA: X7R X7S X7T X7U X6S X6T X5R

L×W (mm)	2.0×1.25																								
T max. (mm)	0.95				1.0				1.35		1.4				1.45										
Rated Voltage (Vdc)	35	25	4	2.5	35	25	16	16	50	25	16	4	100	50	35	25	35	25	16	4	100	50	35	25	
Cap. / TC Code	X5R	X5R	X5R	X6T	X6S	X7S	X6S	X7S	X5R	B	X5R	B	X7R	X5R	B	X6S	X7U	X7S	X7S	X6S	X7S	X6S	X5R	X7S	X6S
100pF																									
150pF																									
220pF																									
330pF																									
470pF																									
680pF																									
820pF																									
1000pF																									
1500pF																									
2200pF																									
3300pF																									
4700pF																									
6800pF																									
10000pF																									
15000pF																									
22000pF																									
33000pF																									
47000pF																									
68000pF																									
0.10μF																									
0.15μF																									
0.22μF																									
0.33μF																									
0.47μF																									
0.68μF																									
1.0μF																								p57	
2.2μF															p57										
4.7μF	p56	p56			p56	p56	p56	p56				p56	p56											p57	
10μF									p56	p56														p57	
22μF									p56															p57	
47μF			p56	p56																					
100μF																									
220μF																									

Continued on the following page. ↗

Capacitance Table

(→ GRM Series High Dielectric Constant Type)

p00 ← Part Number List JIS: R B EIA: X7R X7S X7T X7U X6S X6T X5R

L×W (mm)	2.0×1.25												3.2×1.6															
	1.45												0.95		1.8						1.9							
T max. (mm)	1.45												0.95		1.8						1.9							
Rated Voltage (Vdc)	25	16			10			6.3			4		2.5	16	50	25	10			6.3		4	100	50				
Cap. / TC Code	X5R	X7S	X6S	X5R	X7T	X6S	X5R	X7T	X5R	B	X6S	X5R	B	X6S	X5R	B	X7R	X7R	X7R	X5R	X7R	X7U	X5R	X7U	X7S	X7T		
100pF																												
150pF																												
220pF																												
330pF																												
470pF																												
680pF																												
820pF																												
1000pF																												
1500pF																												
2200pF																												
3300pF																												
4700pF																												
6800pF																												
10000pF																												
15000pF																												
22000pF																												
33000pF																												
47000pF																												
68000pF																												
0.10μF																												
0.15μF																												
0.22μF																												
0.33μF																												
0.47μF																												
0.68μF																												
1.0μF																												
2.2μF																												
4.7μF																												
10μF		p57																										
22μF	p57		p57	p57	p57	p57	p57								p57	p57												
47μF								p57	p57	p57	p57	p57	p57															
100μF									p57																			
220μF																												

Continued on the following page. ↗

Capacitance Table

(→ GRM Series High Dielectric Constant Type)

p00 ← Part Number List JIS: R B EIA: X7R X7S X7T X7U X6S X6T X5R

L×W (mm)	3.2×1.6												3.2×2.5						4.5×3.2													
	1.9												2.7						2.8			1.5										
T max. (mm)	1.9												2.7						2.8			1.5										
Rated Voltage (Vdc)	35	25	16		10		6.3		4		2.5	100	25	16		10	6.3	4	6.3	4	630	500	250									
Cap. / TC Code	X7T	X6S	X7S	X5R	X6S	X5R	X6T	X5R	X7U	X6T	X5R	X5R	X7S	X7R	X7R	X6S	X7R	X5R	X7R	X7U	X7U	X5R	X5R	X7R	X7R	X7R						
100pF																																
150pF																																
220pF																																
330pF																																
470pF																																
680pF																																
820pF																																
1000pF																																
1500pF																																
2200pF																																
3300pF																																
4700pF																																
6800pF																																
10000pF																																
15000pF																																
22000pF																																
33000pF																																
47000pF																																
68000pF																																
0.10μF																											p57					
0.15μF																											p57	p57				
0.22μF																																
0.33μF																																
0.47μF																																
0.68μF																																
1.0μF																																
2.2μF																																
4.7μF																																
10μF	p57																											p57				
22μF		p57	p57																										p57	p57		
47μF				p57	p57																									p57		
100μF																														p57	p57	p57
220μF																														p57	p57	

Continued on the following page. ↗

Capacitance Table

(→ GRM Series High Dielectric Constant Type)

p00 ← Part Number List JIS: R B EIA: X7R X7S X7T X7U X6S X6T X5R

L×W (mm)	4.5×3.2				5.7×5.0				
T max. (mm)	2.0				2.0				
Rated Voltage (Vdc)	1000	630	500	250	1000	630	500	250	200
Cap. / TC Code	X7R	X7R	X7R	X7R	X7R	X7R	X7R	X7R	X7R
100pF									
150pF									
220pF									
330pF									
470pF									
680pF									
820pF									
1000pF									
1500pF									
2200pF									
3300pF									
4700pF									
6800pF									
10000pF									
15000pF									
22000pF									
33000pF	p57								
47000pF	p57								
68000pF					p58				
0.10μF		p57			p58				
0.15μF						p58			
0.22μF			p57	p58		p58			
0.33μF				p58			p58	p58	p58
0.47μF				p58			p58	p58	p58
0.68μF								p58	p58
1.0μF								p58	p58
2.2μF									
4.7μF									
10μF									
22μF									
47μF									
100μF									
220μF									

Capacitance Table

GR3 Series High Dielectric Constant Type

p00 ← Part Number List EIA: X7T

L×W (mm)	2.0×1.25		3.2×1.6						3.2×2.5						4.5×3.2				5.7×5.0				
T max. (mm)	1.0	1.45	1.0		1.25		1.8		1.5		2.0		1.5		2.0		2.0		2.7				
Rated Voltage (Vdc)	250	250	450	250	630	450	250	630	450	250	630	250	630	450	250	630	450	250	630	450	250	630	250
Cap. / TC Code	X7T	X7T	X7T	X7T	X7T	X7T	X7T	X7T	X7T	X7T	X7T	X7T	X7T	X7T	X7T	X7T	X7T	X7T	X7T	X7T	X7T	X7T	X7T
10000pF	p60		p60		p60																		
15000pF	p60		p60				p60																
22000pF		p60			p60				p60														
33000pF			p60		p60						p60												
47000pF					p60		p60				p60												
68000pF							p60				p60				p60								
0.10μF									p60		p60								p60				
0.15μF												p60				p60			p60				
0.22μF														p60				p60		p60			
0.33μF															p60			p60		p60			
0.47μF																	p60	p60					
0.68μF																		p60					
1.0μF																							p60

GRJ Series High Dielectric Constant Type

p00 ← Part Number List EIA: X7R X7S X5R

L×W (mm)	2.0×1.25		3.2×1.6		3.2×2.5						4.5×3.2				5.7×5.0	
T max. (mm)	1.45	1.5	1.9		2.8		2.85		1.5		2.0		2.0			
Rated Voltage (Vdc)	25	100	100	50	10	25	630	250	1000	630	250	1000	630	250		
Cap. / TC Code	X5R	X7S	X7S	X7R	X7R	X7S	X7R	X7R	X7R	X7R	X7R	X7R	X7R	X7R		
33000pF									p62							
47000pF									p62							
68000pF							p62					p62				
0.10μF									p62			p62				
0.15μF								p62				p62				
0.22μF										p62		p62				
0.33μF											p62		p62			
0.47μF												p62		p62		
0.68μF													p62	p62		
1.0μF		p62												p62		
4.7μF			p62	p62												
10μF	p62															
22μF						p62										
47μF					p62											

Capacitance Table

GR4 Series Temperature Compensating Type

p00 ← Part Number List EIA: U2J

L×W (mm)	3.2×1.6			3.2×2.5		
	1.0	1.25	1.8	1.5	2.0	2.7
T max. (mm)	1.0	1.25	1.8	1.5	2.0	2.7
Rated Voltage (Vdc)	630	630	630	630	630	630
Cap. / TC Code	U2J	U2J	U2J	U2J	U2J	U2J
1000pF	p64					
1500pF	p64					
2200pF	p64					
3300pF		p64				
4700pF			p64			
6800pF				p64		
10000pF					p64	
15000pF						p64

GR4 Series High Dielectric Constant Type

p00 ← Part Number List EIA: X7R

L×W (mm)	4.5×2.0	4.5×3.2		5.7×5.0
	1.5	1.5	2.0	2.0
T max. (mm)	1.5	1.5	2.0	2.0
Rated Voltage (Vdc)	2000	2000	2000	2000
Cap. / TC Code	X7R	X7R	X7R	X7R
100pF	p65			
120pF	p65			
150pF	p65			
180pF	p65			
220pF	p65			
270pF	p65			
330pF	p65			
390pF	p65			
470pF	p65			
560pF	p65			
680pF	p65			
820pF	p65			
1000pF	p65			
1200pF	p65			
1500pF	p65			
1800pF		p65		
2200pF		p65		
2700pF		p65		
3300pF		p65		
3900pF		p65		
4700pF			p65	
10000pF				p65

Capacitance Table

GJM Series Temperature Compensating Type

p00 ← Part Number List

JIS: CK CJ CH

EIA: COG

Murata Temperature Characteristic: X8G

L×W (mm)	0.4×0.2			0.6×0.3				1.0×0.5		
	T max. (mm)			0.33				0.55		
Rated Voltage (Vdc)	25			100	50	25	50			
Cap. / TC Code	COG	CA	COG	CA	X8G	COG	COG	CA	COG	CA
0.10pF									p73	p76
0.20pF	p67	p68				p71			p73	p76
0.30pF	p67	p68	p69	p69	p70	p71			p73	p76
0.40pF	p67	p68	p69	p69	p70	p71			p73	p76
0.50pF	p67	p68	p69	p69	p70	p71			p73	p76
0.60pF	p67	p68	p69	p69	p70	p71			p73	p76
0.70pF	p67	p68	p69	p70	p70	p71			p73	p76
0.80pF	p67	p68	p69	p70	p70	p71			p73	p76
0.90pF	p67	p68	p69	p70	p70	p71			p73	p76
1.0pF	p67	p68	p69	p70	p70		p71	p72	p73	p76
1.1pF	p67	p68	p69	p70	p70		p71	p72	p73	p77
1.2pF	p67	p68	p69	p70	p70		p71	p72	p73	p77
1.3pF	p67	p68	p69	p70	p71		p71	p72	p73	p77
1.4pF	p67	p68	p69	p70			p71	p72	p73	p77
1.5pF	p67	p68	p69	p70	p71		p71	p72	p73	p77
1.6pF	p67	p68	p69	p70	p71		p71	p72	p73	p77
1.7pF	p67	p68	p69	p70			p71	p72	p73	p77
1.8pF	p67	p68	p69	p70	p71		p71	p72	p73	p77
1.9pF	p67	p68	p69	p70			p71	p72	p73	p77
2.0pF	p67	p68	p69	p70	p71		p71	p72	p73	p77
2.1pF	p67	p68	p69	p70			p71	p72	p73	p77
2.2pF	p67	p68	p69	p70	p71		p71	p72	p73	p77
2.3pF	p67	p68	p69	p70			p71	p72	p73	p77
2.4pF	p67	p68	p69	p70	p71		p71	p72	p73	p77
2.5pF	p67	p68	p69	p70			p71	p72	p73	p77
2.6pF	p67	p68	p69	p70			p71	p72	p73	p77
2.7pF	p67	p68	p69	p70	p71		p71	p72	p73	p77
2.8pF	p67	p68	p69	p70			p71	p72	p73	p77
2.9pF	p67	p68	p69	p70			p71	p72	p74	p77
3.0pF	p67	p68	p69	p70	p71		p71	p72	p74	p77
3.1pF	p67	p68	p69	p70			p71	p72	p74	p77
3.2pF	p67	p68	p69	p70			p71	p72	p74	p77
3.3pF	p67	p68	p69	p70	p71		p71	p72	p74	p77
3.4pF	p67	p68	p69	p70			p71	p72	p74	p77
3.5pF	p67	p68	p69	p70			p71	p72	p74	p77
3.6pF	p67	p68	p69	p70	p71		p71	p72	p74	p77
3.7pF	p67	p68	p69	p70			p71	p72	p74	p77
3.8pF	p67	p68	p69	p70			p71	p72	p74	p77
3.9pF	p67	p68	p69	p70	p71		p71	p72	p74	p77
4.0pF	p67	p68	p69	p70			p71	p72	p74	p77
4.1pF	p67	p68	p69	p70			p71	p72	p74	p77
4.2pF	p67	p68	p69	p70			p71	p72	p74	p77
4.3pF	p67	p68	p69	p70	p71		p71	p72	p74	p77
4.4pF	p67	p68	p69	p70			p71	p72	p74	p77
4.5pF	p67	p68	p69	p70			p71	p72	p74	p77
4.6pF	p67	p68	p69	p70			p71	p72	p74	p77
4.7pF	p67	p68	p69	p70	p71		p71	p72	p74	p78
4.8pF	p67	p68	p69	p70			p71	p72	p74	p78
4.9pF	p67	p68	p69	p70			p71	p72	p74	p78
5.0pF	p67	p68	p69	p70			p71	p72	p74	p78
5.1pF	p67	p68	p69	p70	p71		p71	p72	p74	p78
5.2pF	p67	p68	p69	p70			p71	p72	p74	p78
5.3pF	p67	p68	p69	p70			p71	p72	p74	p78
5.4pF	p67	p68	p69	p70			p71	p72	p74	p78
5.5pF	p67	p68	p69	p70			p71	p72	p74	p78
5.6pF	p67	p68	p69	p70	p71		p71	p72	p74	p78
5.7pF	p67	p68	p69	p70			p71	p72	p74	p78
5.8pF	p67	p68	p69	p70			p71	p72	p74	p78

L×W (mm)	0.4×0.2			0.6×0.3				1.0×0.5			
	T max. (mm)			0.33				0.55			
Rated Voltage (Vdc)	25			100	50	25	50				
Cap. / TC Code	COG	CA	COG	CA	X8G	COG	COG	CA	COG	CA	
5.9pF	p67	p68	p69	p70				p71	p72	p74	p78
6.0pF	p67	p68	p69	p70				p71	p72	p74	p78
6.1pF	p67	p68	p69	p70				p71	p72	p74	p78
6.2pF	p67	p68	p69	p70	p71			p71	p72	p75	p78
6.3pF	p67	p68	p69	p70				p71	p72	p75	p78
6.4pF	p67	p68	p69	p70				p71	p72	p75	p78
6.5pF	p67	p68	p69	p70				p71	p72	p75	p78
6.6pF	p67	p68	p69	p70				p71	p72	p75	p78
6.7pF	p67	p68	p69	p70				p71	p72	p75	p78
6.8pF	p67	p68	p69	p70	p71			p71	p72	p75	p78
6.9pF	p67	p68	p69	p70				p71	p72	p75	p78
7.0pF	p67	p68	p69	p70				p71	p72	p75	p78
7.1pF	p67	p68	p69	p70				p71	p72	p75	p78
7.2pF	p67	p68	p69	p70				p71	p72	p75	p78
7.3pF	p67	p68	p69	p70				p71	p72	p75	p78
7.4pF	p67	p68	p69	p70				p71	p72	p75	p78
7.5pF	p67	p68	p69	p70	p71	p71	p71	p72	p75	p79	
7.6pF	p67	p68	p69	p70				p71	p72	p75	p79
7.7pF	p67	p68	p69	p70				p71	p72	p75	p79
7.8pF	p67	p68	p69	p70				p71	p72	p75	p79
7.9pF	p67	p68	p69	p70				p71	p72	p75	p79
8.0pF	p67	p68	p69	p70				p72	p72	p75	p79
8.1pF	p67	p68	p69	p70				p72	p72	p75	p79
8.2pF	p67	p68	p69	p70	p71	p71	p72	p72	p75	p79	
8.3pF	p67	p68	p69	p70				p72	p72	p75	p79
8.4pF	p67	p68	p69	p70				p72	p72	p75	p79
8.5pF	p67	p68	p69	p70				p72	p73	p75	p79
8.6pF	p67	p68	p69	p70				p72	p73	p75	p79
8.7pF	p67	p68	p69	p70				p72	p73	p75	p79
8.8pF	p67	p68	p69	p70				p72	p73	p75	p79
8.9pF	p67	p68	p69	p70				p72	p73	p76	p79
9.0pF	p67	p68	p69	p70				p72	p73	p76	p79
9.1pF	p67	p68	p69	p70	p71	p71	p72	p73	p76	p79	
9.2pF	p67	p68	p69	p70				p72	p73	p76	p79
9.3pF	p67	p68	p69	p70				p72	p73	p76	p79
9.4pF	p67	p68	p69	p70				p72	p73	p76	p79
9.5pF	p67	p68	p69	p70				p72	p73	p76	p79
9.6pF	p67	p68	p69	p70				p72	p73	p76	p79
9.7pF	p67	p68	p69	p70				p72	p73	p76	p79
9.8pF	p67	p68	p69	p70				p72	p73	p76	p79
9.9pF	p67	p68	p69	p70				p72	p73	p76	p79
10pF	p67	p68	p69	p70	p71	p71	p72	p73	p76	p79	
11pF	p67	p68	p69	p70				p72	p73	p76	p79
12pF	p67	p68	p69	p70	p71	p71	p72	p73	p76	p79	
13pF	p67	p68	p69	p70				p72	p73	p76	p80
15pF	p67	p68	p69	p70	p71	p71	p72	p73	p76	p80	
16pF	p67	p68						p72	p73	p76	p80
18pF	p67	p68						p72	p73	p76	p80
20pF	p67	p68						p72	p73	p76	p80
22pF	p68	p68						p72	p73	p76	p80
24pF								p72	p73	p76	p80
27pF								p72	p73	p76	p80
30pF								p72	p73	p76	p80
33pF								p72	p73	p76	p80
36pF										p76	p80
39pF										p76	p80
43pF										p76	p80
47pF										p76	p80

Capacitance Table

GQM Series High Dielectric Constant Type

p00 ← Part Number List EIA: COG Murata Temperature Characteristic: X8G

L×W (mm)	1.0×0.5		1.6×0.8		2.0×1.25		2.8×2.8
T max. (mm)	0.55		0.8		1.0		1.35
Rated Voltage (Vdc)	200	100	250	500	250	500	500
Cap. / TC Code	COG	COG	COG	X8G	X8G	COG	X8G
0.10pF	p82						
1.0pF	p82		p83	p83	p84	p85	p86
1.1pF	p82		p83	p83	p84	p85	p86
1.2pF	p82		p83	p84	p84	p85	p86
1.3pF	p82		p83	p84	p84	p85	p86
1.5pF	p82		p83	p84	p84	p85	p86
1.6pF	p82		p83	p84	p84	p85	p86
1.8pF	p82		p83	p84	p84	p85	p86
2.0pF	p82		p83	p84	p84	p85	p86
2.2pF	p82		p83	p84	p84	p85	p86
2.4pF	p82		p83	p84	p84	p85	p86
2.7pF	p82		p83	p84	p84	p85	p86
3.0pF	p82		p83	p84	p85	p85	p86
3.3pF	p82		p83	p84	p85	p85	p86
3.6pF	p82		p83	p84	p85	p85	p86
3.9pF	p82		p83	p84	p85	p85	p86
4.0pF	p82		p83	p84	p85	p85	p86
4.3pF	p82		p83	p84	p85	p85	p86
4.7pF	p82		p83	p84	p85	p85	p86
5.0pF	p82		p83	p84	p85	p85	p86
5.1pF	p82		p83	p84	p85	p85	p86
5.6pF	p82		p83	p84	p85	p85	p86
6.0pF	p82		p83	p84	p85	p85	p86
6.2pF	p82		p83	p84	p85	p85	p86
6.8pF	p82		p83	p84	p85	p85	p86
7.0pF	p82		p83	p84	p85	p85	p86
7.5pF	p82		p83	p84	p85	p85	p87
8.0pF	p82		p83	p84	p85	p86	p87
8.2pF	p82		p83	p84	p85	p86	p87
9.0pF	p82		p83	p84	p85	p86	p87
9.1pF	p82		p83	p84	p85	p86	p87
10pF	p82		p83	p84	p85	p86	p87
11pF	p82		p83	p84	p85	p86	p87
12pF	p82		p83	p84	p85	p86	p87
13pF	p82		p83	p84	p85	p86	p87
15pF	p82		p83	p84	p85	p86	p87
16pF	p82		p83	p84	p85	p86	p87
18pF	p82		p83	p84	p85	p86	p87
20pF	p82		p83	p84	p85	p86	p87
22pF	p82		p83	p84	p85	p86	p87
24pF	p82		p83	p84		p86	p87
27pF	p82		p83	p84		p86	p87
30pF	p82		p83	p84		p86	p87
33pF	p82		p83			p86	p87
36pF		p82	p83			p86	p87
39pF		p83	p83			p86	p87
43pF		p83	p83			p86	p87
47pF		p83	p83			p86	p87
51pF						p86	p87
56pF						p86	p87
62pF						p86	p87
68pF						p86	p87
75pF						p86	p87
82pF						p86	p87
91pF						p86	p88
100pF						p86	p88

The indication for every 0.1 pF has been omitted for less than 1.0 pF. Refer to the Part Number List for details.

Capacitance Table

GA2 Series High Dielectric Constant Type

p00 ← Part Number List EIA: X7R

L×W (mm)	4.5× 2.0	4.5×3.2		5.7× 5.0
T max. (mm)	1.5	1.5	2.0	2.0
Rated Voltage (Vac(r.m.s.))	250	250	250	250
Cap. / TC Code	X7R	X7R	X7R	X7R
470pF	p90			
1000pF	p90			
2200pF		p90		
3300pF		p90		
4700pF			p90	
10000pF		p90		
22000pF		p90		
47000pF			p90	
0.10μF				p90

GA3 Series Type GB High Dielectric Constant Type

p00 ← Part Number List EIA: X7R

L×W (mm)	5.7×5.0			
T max. (mm)	1.5	2.0	2.5	2.9
Rated Voltage (Vac(r.m.s.))	250	250	250	250
Cap. / TC Code	X7R	X7R	X7R	X7R
10000pF	p93			
15000pF	p93			
22000pF		p93		
33000pF			p93	
47000pF			p93	
56000pF				p93

GA3 Series Type GD Temperature Compensating Type

p00 ← Part Number List JIS: SL

L×W (mm)	4.5× 2.0
T max. (mm)	1.0
Rated Voltage (Vac(r.m.s.))	250
Cap. / TC Code	SL
10pF	p95
12pF	p95
15pF	p95
18pF	p95
22pF	p95
27pF	p95
33pF	p95
39pF	p95
47pF	p95
56pF	p95
68pF	p95
82pF	p95

GA3 Series Type GD High Dielectric Constant Type

p00 ← Part Number List EIA: X7R

L×W (mm)	4.5× 2.0	4.5×3.2	
T max. (mm)	1.5	1.5	2.0
Rated Voltage (Vac(r.m.s.))	250	250	250
Cap. / TC Code	X7R	X7R	X7R
100pF	p96		
150pF	p96		
220pF	p96		
330pF	p96		
470pF	p96		
680pF	p96		
1000pF	p96		
1500pF	p96		
1800pF		p96	
2200pF		p96	
4700pF			p96

Capacitance Table

GA3 Series Type GF Temperature Compensating Type

p00 ← Part Number List JIS: SL

L×W (mm)	4.5×2.0
T max. (mm)	1.0
Rated Voltage (Vac(r.m.s.))	250
Cap. / TC Code	SL
10pF	p99
12pF	p99
15pF	p99
18pF	p99
22pF	p99
27pF	p99
33pF	p99
39pF	p99
47pF	p99
56pF	p99
68pF	p99
82pF	p99

GA3 Series Type GF High Dielectric Constant Type

p00 ← Part Number List EIA: X7R

L×W (mm)	4.5×2.0		5.7×2.8		5.7×5.0	
T max. (mm)	1.5	2.2	1.5	1.5	2.0	
Rated Voltage (Vac(r.m.s.))	250	250	250	250	250	250
Cap. / TC Code	X7R	X7R	X7R	X7R	X7R	X7R
100pF	p100		p100			
150pF	p100		p100			
220pF		p100	p100			
330pF		p100	p100			
470pF	p100		p100			
680pF	p100		p100			
1000pF		p100	p100			
1500pF			p100			
1800pF				p100		
2200pF				p100		
3300pF				p100		
4700pF					p100	

Capacitance Table

LLL Series High Dielectric Constant Type

p00 ← Part Number List EIA: X7R X7S X6S X5R

L×W (mm)	0.5×1.0			0.8×1.6										1.25×2.0													
	0.35			0.45			0.5				0.55		0.6				0.5					0.7			0.95		
Rated Voltage (Vdc)	6.3	4		4	25	16	10	4	4	50	25	16	10	4	50	25	16	10	6.3	4	50	25	10	16	10	4	
Cap. / TC Code	X6S	X7S	X6S	X5R	X7R	X7R	X7R	X7S	X7S	X7R	X7R	X7R	X7R	X7S	X7R	X7R	X7R	X7R	X7R	X7R	X7S	X7R	X7R	X7R	X7R	X7S	
2200pF															p102												
4700pF															p102												
10000pF															p102												
22000pF															p102												
47000pF															p102												
0.10μF	p102																										
0.22μF	p102																										
0.47μF		p102																									
1.0μF			p102																								
2.2μF																											
4.3μF																											
4.7μF																											
10μF																											

Continued to the following table. ↗

L×W (mm)	1.6×3.2														
	0.5				0.8					1.25					
Rated Voltage (Vdc)	50	25	16	10	50	25	16	10	6.3	50	25	16	10	6.3	
Cap. / TC Code	X7R	X7R	X7R	X7R	X7R	X7R	X7R	X7R	X7R	X7R	X7R	X7R	X7R	X7R	X5R
2200pF															
4700pF															
10000pF															
22000pF															
47000pF															
0.10μF															
0.22μF															
0.47μF															
1.0μF															
2.2μF															
4.3μF															
4.7μF															
10μF															

LLA Series High Dielectric Constant Type

p00 ← Part Number List EIA: X7R X7S

L×W (mm)	2.0×1.25										
	0.55					0.95					
Rated Voltage (Vdc)	4	25	16	10	6.3	4	25	16	10	6.3	4
Cap. / TC Code	X7S	X7R	X7R	X7R	X7R	X7S	X7R	X7R	X7R	X7R	X7S
10000pF											
22000pF											
47000pF											
0.10μF											
0.22μF											
0.47μF											
1.0μF											
2.2μF											
4.7μF											

Capacitance Table

LLM Series High Dielectric Constant Type

p00 ← Part Number List EIA: X7R X7S

L×W (mm)	2.0×1.25			
T max. (mm)	0.55			
Rated Voltage (Vdc)	25	16	6.3	4
Cap. / TC Code	X7R	X7R	X7R	X7S
10000pF	p106			
22000pF	p106			
47000pF		p106		
0.10μF		p106		
0.22μF			p106	
0.47μF			p106	
1.0μF				p106

LLR Series High Dielectric Constant Type

p00 ← Part Number List EIA: X7S

L×W (mm)	0.8×1.6			
T max. (mm)	0.55			
Rated Voltage (Vdc)	4			
TC Code	X7S			
Cap. / ESR (mΩ)	100	220	470	1000
1.0μF	p108	p108	p108	p108

NFM Series

p00 ← Part Number List

L×W (mm)	1.0×0.5								1.6×0.8				2.0×1.25					3.2×1.25	3.2×1.6			4.5×1.6			
T max. (mm)	0.35		0.5			0.65	0.7	0.7	0.9	0.95				0.9	1.5			1.2							
Rated Voltage (Vdc)	6.3	4	16	10	6.3	2.5	2.5	2.5	16	6.3	10	6.3	50	25	16	10	6.3	50	100	50	6.3	100	50	25	
Cap. / TC Code	-	-	-	-	-	-	-	-	-	-	-	-	-	-	-	-	-	-	-	-	-	-	-	-	
100pF																									
220pF																									
470pF																									
1000pF																									
2200pF																									
10000pF																									
15000pF																									
22000pF																									
47000pF																									
0.10μF																									
0.22μF																									
0.47μF																									
1.0μF																									
1.5μF																									
2.2μF																									
4.3μF																									
4.7μF																									
7.5μF																									
9.1μF																									
10μF																									
27μF																									

KRM Series Temperature Compensating Type

p00 ← Part Number List EIA: COG

L×W (mm)	6.1×5.1			
T max. (mm)	3.1	3.9	5.1	6.6
Rated Voltage (Vdc)	630	630	630	630
Cap. / TC Code	COG	COG	COG	COG
0.015μF	p114			
0.018μF	p114			
0.022μF		p114		
0.027μF		p114		
0.030μF			p114	
0.036μF			p114	
0.044μF				p114
0.054μF				p114

Capacitance Table

KRM Series High Dielectric Constant Type

p00 ← Part Number List EIA: X7R X7S X6S X5R

L×W (mm)	2.2×1.25					3.5×1.7					3.6×1.7	3.7×1.85	6.1×5.3														
T max. (mm)	1.9		2.0			2.9					2.9		3.0										3.9				
Rated Voltage (Vdc)	25	16	25			25	100	50	35	25	50	100	1000	630	450	250	100	63	50	35	25	100	63	50	35	25	
Cap. / TC Code	X5R	X5R	X7S	X6S	X5R	X5R	X7R	X7R	X6S	X6S	X7R	X7R	X7R	X7R	X7R	X7R	X7R	X7R	X7R	X7R	X7R	X7R	X7R	X7R	X7R	X7R	
68000pF																											
0.10μF																											
0.15μF																											
0.22μF																											
0.33μF																											
0.47μF																											
0.68μF																											
1.0μF																											
1.5μF																											
2.2μF																											
4.7μF																											
6.8μF																											
10μF	p115	p115	p115	p115																							
15μF																											
17μF																											
22μF																											
33μF																											
47μF																											
68μF																											
100μF																											

Continued to the following table. ↙

L×W (mm)	6.1×5.3													
T max. (mm)	3.9		5.0										6.7	
Rated Voltage (Vdc)	25	1000	630	450	250	100	50	35	25	100	63	50	35	25
Cap. / TC Code	X7S	X7R	X7R	X7R	X7R	X7R	X7R	X7R	X7R	X7R	X7R	X7R	X7R	X7S
68000pF														
0.10μF														
0.15μF														
0.22μF														
0.33μF														
0.47μF														
0.68μF														
1.0μF														
1.5μF														
2.2μF														
4.7μF														
6.8μF														
10μF														
15μF														
17μF														
22μF														
33μF														
47μF														
68μF														
100μF														

Capacitance Table

KR3 Series High Dielectric Constant Type

p00 ← Part Number List EIA: X7T

L×W (mm)	6.1×5.3									
	3.0			3.9			5.0		6.7	
T max. (mm)	3.0			3.9			5.0		6.7	
Rated Voltage (Vdc)	630	450	250	630	450	450	250	630	450	250
Cap. / TC Code	X7T	X7T	X7T	X7T	X7T	X7T	X7T	X7T	X7T	X7T
0.10μF	p118									
0.15μF	p118									
0.22μF		p118		p118						
0.27μF				p118						
0.33μF		p118								
0.47μF		p118	p118						p118	
0.56μF					p118				p118	
0.68μF			p118			p118				
1.0μF					p118	p118				
1.2μF									p118	
1.5μF							p118			
2.2μF										p118

GMA Series High Dielectric Constant Type

p00 ← Part Number List JIS: R B EIA: X7R X5R

L×W (mm)	0.38×0.38			0.5×0.5						0.8×0.8									
	0.35			0.4						0.6									
Rated Voltage (Vdc)	10			100	25	10	6.3	100	25	10	6.3	100	25	10	6.3				
Cap. / TC Code	X7R	R	B	X7R	X7R	B	X7R	R	B	X5R	B	X7R	X7R	B	X7R	R	B	X5R	B
100pF				p121															
150pF				p121															
220pF				p121															
330pF				p121															
470pF				p121															
680pF				p121															
1000pF	p121	p121	p121	p121															
1500pF	p121	p121	p121		p121	p121						p121							
1800pF	p121	p121	p121																
2200pF					p121	p121						p121							
3300pF					p121	p121						p121							
4700pF					p121	p121						p121							
6800pF							p121	p121	p121			p121							
10000pF	p121	p121					p121	p121	p121				p121	p121					
15000pF							p121	p121	p121				p121	p121					
22000pF							p121	p121	p121				p121	p121					
33000pF															p121	p121	p121		
47000pF															p121	p121	p121		
68000pF															p121	p121	p121		
0.10μF												p121	p121						
0.47μF																		p121	p121

Capacitance Table

GMD Series High Dielectric Constant Type

p00 ← Part Number List JIS: R B EIA: X7R X5R

L×W (mm)	0.6×0.3											1.0×0.5										
	0.33											0.55										
	25			16			10			6.3		50			25			16			10	
Rated Voltage (Vdc)	X7R	R	B	X7R	R	B	X7R	R	B	X5R	B	X7R	R	B	X7R	R	B	X7R	R	B	X5R	B
Cap. / TC Code	X7R	R	B	X7R	R	B	X7R	R	B	X5R	B	X7R	R	B	X7R	R	B	X7R	R	B	X5R	B
100pF	p123	p123	p123																			
120pF	p123	p123	p123																			
150pF	p123	p123	p123																			
180pF	p123	p123	p123																			
220pF	p123	p123	p123									p123	p123	p124								
270pF	p123	p123	p123									p123	p124	p124								
330pF	p123	p123	p123									p123	p124	p124								
390pF	p123	p123	p123									p123	p124	p124								
470pF	p123	p123	p123									p123	p124	p124								
560pF	p123	p123	p123									p123	p124	p124								
680pF	p123	p123	p123									p123	p124	p124								
820pF	p123	p123	p123									p123	p124	p124								
1000pF	p123	p123	p123									p123	p124	p124								
1200pF	p123	p123	p123									p123	p124	p124								
1500pF	p123	p123	p123									p123	p124	p124								
1800pF				p123	p123	p123						p123	p124	p124								
2200pF				p123	p123	p123						p123	p124	p124								
2700pF				p123	p123	p123						p123	p124	p124								
3300pF				p123	p123	p123						p123	p124	p124								
3900pF							p123	p123	p123			p123	p124	p124								
4700pF							p123	p123	p123			p123	p124	p124								
5600pF							p123	p123	p123						p124	p124	p124					
6800pF							p123	p123	p123						p124	p124	p124					
8200pF							p123	p123	p123						p124	p124	p124					
10000pF							p123	p123	p123						p124	p124	p124					
12000pF															p124	p124	p124					
15000pF															p124	p124	p124					
18000pF															p124	p124	p124					
22000pF															p124	p124	p124					
27000pF															p124	p124	p124					
33000pF															p124	p124	p124					
39000pF															p124	p124	p124					
47000pF															p124	p124	p124					
56000pF										p123	p123							p124	p124	p124		
68000pF										p123	p123							p124	p124	p124		
82000pF										p123	p123							p124	p124	p124		
0.10μF										p123	p123							p124	p124	p124		
0.12μF																					p124	p124
0.15μF																					p124	p124
0.18μF																					p124	p124
0.22μF																					p124	p124
0.27μF																					p124	p124
0.33μF																					p124	p124
0.39μF																					p124	p124
0.47μF																					p124	p124

Search Capacitors

Specifications and Test Methods, Package, Chart of Characteristic Data, please refer to the search web page.
<https://www.murata.com/en-global/products/capacitor>

Links are provided to the product detail pages on the web, and are shown below in the product number table from the PDF version of the catalog which is available on the web.

GRM Series Temperature Compensating

0.25×0.125mm

T max.	Rated Voltage	TC Code	Cap.	Tol.	Part Number
0.138mm	25Vdc	COG	0.20pF	±0.1pF	GRM015C1ER20BE11#
			0.30pF	±0.1pF	GRM015C1ER30BE11#
			0.40pF	±0.1pF	GRM015C1ER40BE11#
			0.50pF	±0.1pF	GRM015C1ER50BE11#
			0.60pF	±0.1pF	GRM015C1ER60BE11#
			0.70pF	±0.1pF	GRM015C1ER70BE11#
			0.80pF	±0.1pF	GRM015C1ER80BE11#
			0.90pF	±0.1pF	GRM015C1ER90BE11#

The screenshot shows a detailed product page for GRM0332C1E102JA01#. Key sections include:

- Appearance & Shape:** Shows a 3D model of the capacitor and its physical appearance.
- Specifications:** Lists technical parameters such as capacitance, tolerance, and temperature characteristics.
- References:** Provides links to related documents and standards.
- Characteristic Data:** Contains multiple graphs showing the relationship between capacitance, impedance, and other properties under various conditions.

Status and Features Icons

The status and features of products can be checked at once. When ? is clicked, a description of each icon will be displayed

Stock Check (Where to buy)

Some products can request free samples. Reference inventory information from agents and web-based companies.

Data Sheet

The product details page can be output in PDF.

How to read part numbers

Describes the meaning of the part number

Series Information

This links to the introduction page of each series.

Detailed Specifications Sheet

- Rated value
- Specifications and Test Methods
- Package
- Caution, Notice (Storage, Soldering and Mounting,etc.)

Characteristics Data

The following characteristics data of the main products can be acquired.

- SPICE Netlist (mod type)
- S parameter (S2P type)
- Reliability Test Data *Typical data

- Shape (Dimensions)
- Rated Values

- Specification by Packaging Code/ Minimum Order Quantity
- Weight (1 pc/ø180mm reel)

Chart of Characteristic Data

The main products published characteristic data.

- Frequency characteristics (ESR, Impedance)
- DC bias characteristics
- AC voltage characteristics
- Capacitance - temperature characteristics
- Calorific property by ripple current

Chip Multilayer Ceramic Capacitors for General Purpose

GRM Series



This is Murata primary products renowned for both small size and large capacitance value with latest advanced technology.

Features

① Achieves large-capacity and small size in a multilayer structure.

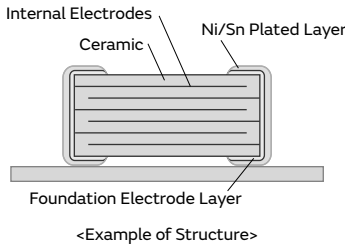

"Thin Layer Technology" for thinner layers

"Fine Particle Technology" for finer particles

"High Precision Lamination Technology" for more accuracy

ceramic thickness: 1µm
 Internal electrode thickness: 0.7µm

ceramic thickness: 0.5µm
 Internal electrode thickness: 0.4µm

② Sn plating is applied to the external electrodes; excellent solderability.

③ High reliability with no polarity.

	Ceramic Capacitors	Tantalum Capacitor	Aluminum Electrolytic Capacitor	Conductive Polymer Capacitor
Price	○	○	◎	○
Comparison between Impedance Frequency Characteristics	◎	△	△	○
Capacitance temperature characteristics	○	◎	○	○
DC breakdown voltage	◎	△	△	△
Polarity	No	Yes	Yes	Yes
Pulse response	◎	△	△	○
Allowable ripple current	◎	△	△	△
Reliability	◎	○	○	○
DC bias characteristics	△	◎	◎	◎

◎: Particularly excellent ○: Excellent △: Inferior

Specifications

Size (mm)	0.25×0.125mm to 5.7×5.0mm
Rated Voltage	2.5Vdc to 3150Vdc
Capacitance	0.10pF to 330µF
Main Applications	1. Rated voltage 100V Max. High Dielectric Constant Type . . . For decoupling and smoothing circuits Temperature Compensating Type . . . For tuning circuits, oscillating circuits, and high frequency filter circuits 2. Rated voltage 200V min. High Dielectric Constant Type . . . For clamp snubber circuits and smoothing circuits Temperature Compensating Type . . . Power supply damper snubber

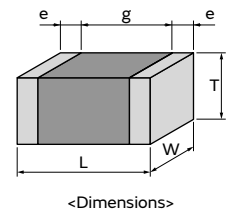

This catalog contains only a portion of the product lineup.
 Please refer to the capacitor search tool on the Murata Web site for details.

GRM Series Temperature Compensating Type Part Number List

0.25×0.125mm

T max.	Rated Voltage	TC Code	Cap.	Tol.	Part Number
0.138mm	25Vdc	COG	0.20pF	±0.1pF	GRM0115C1ER20BE11#
			0.30pF	±0.1pF	GRM0115C1ER30BE11#
			0.40pF	±0.1pF	GRM0115C1ER40BE11#
			0.50pF	±0.1pF	GRM0115C1ER50BE11#
			0.60pF	±0.1pF	GRM0115C1ER60BE11#
			0.70pF	±0.1pF	GRM0115C1ER70BE11#
			0.80pF	±0.1pF	GRM0115C1ER80BE11#
			0.90pF	±0.1pF	GRM0115C1ER90BE11#
			1.0pF	±0.25pF	GRM0115C1E1R0CE11#
			1.1pF	±0.25pF	GRM0115C1E1R1CE11#
			1.2pF	±0.25pF	GRM0115C1E1R2CE11#
			1.3pF	±0.25pF	GRM0115C1E1R3CE11#
			1.4pF	±0.25pF	GRM0115C1E1R4CE11#
			1.5pF	±0.25pF	GRM0115C1E1R5CE11#
			1.6pF	±0.25pF	GRM0115C1E1R6CE11#
			1.7pF	±0.25pF	GRM0115C1E1R7CE11#
			1.8pF	±0.25pF	GRM0115C1E1R8CE11#
			1.9pF	±0.25pF	GRM0115C1E1R9CE11#
			2.0pF	±0.25pF	GRM0115C1E2R0CE11#
			2.1pF	±0.25pF	GRM0115C1E2R1CE11#
			2.2pF	±0.25pF	GRM0115C1E2R2CE11#
			2.3pF	±0.25pF	GRM0115C1E2R3CE11#
			2.4pF	±0.25pF	GRM0115C1E2R4CE01#
			2.5pF	±0.25pF	GRM0115C1E2R5CE01#
			2.6pF	±0.25pF	GRM0115C1E2R6CE01#
			2.7pF	±0.25pF	GRM0115C1E2R7CE01#
			2.8pF	±0.25pF	GRM0115C1E2R8CE01#
			2.9pF	±0.25pF	GRM0115C1E2R9CE01#
			3.0pF	±0.25pF	GRM0115C1E3R0CE01#
			3.1pF	±0.25pF	GRM0115C1E3R1CE01#
			3.2pF	±0.25pF	GRM0115C1E3R2CE01#
			3.3pF	±0.25pF	GRM0115C1E3R3CE01#
			3.4pF	±0.25pF	GRM0115C1E3R4CE01#
			3.5pF	±0.25pF	GRM0115C1E3R5CE01#
			3.6pF	±0.25pF	GRM0115C1E3R6CE01#
			3.7pF	±0.25pF	GRM0115C1E3R7CE01#
			3.8pF	±0.25pF	GRM0115C1E3R8CE01#
			3.9pF	±0.25pF	GRM0115C1E3R9CE01#
			4.0pF	±0.25pF	GRM0115C1E4R0CE01#
			4.1pF	±0.25pF	GRM0115C1E4R1CE01#
			4.2pF	±0.25pF	GRM0115C1E4R2CE01#
			4.3pF	±0.25pF	GRM0115C1E4R3CE01#
			4.4pF	±0.25pF	GRM0115C1E4R4CE01#
			4.5pF	±0.25pF	GRM0115C1E4R5CE01#
			4.6pF	±0.25pF	GRM0115C1E4R6CE01#
			4.7pF	±0.25pF	GRM0115C1E4R7CE01#
			4.8pF	±0.25pF	GRM0115C1E4R8CE01#
			4.9pF	±0.25pF	GRM0115C1E4R9CE01#
			5.0pF	±0.25pF	GRM0115C1E5R0CE01#
			5.1pF	±0.5pF	GRM0115C1E5R1DE01#
			5.2pF	±0.5pF	GRM0115C1E5R2DE01#
			5.3pF	±0.5pF	GRM0115C1E5R3DE01#

T max.	Rated Voltage	TC Code	Cap.	Tol.	Part Number
0.138mm	25Vdc	COG	5.4pF	±0.5pF	GRM0115C1E5R4DE01#
			5.5pF	±0.5pF	GRM0115C1E5R5DE01#
			5.6pF	±0.5pF	GRM0115C1E5R6DE01#
			5.7pF	±0.5pF	GRM0115C1E5R7DE01#
			5.8pF	±0.5pF	GRM0115C1E5R8DE01#
			5.9pF	±0.5pF	GRM0115C1E5R9DE01#
			6.0pF	±0.5pF	GRM0115C1E6R0DE01#
			6.1pF	±0.5pF	GRM0115C1E6R1DE01#
			6.2pF	±0.5pF	GRM0115C1E6R2DE01#
			6.3pF	±0.5pF	GRM0115C1E6R3DE01#
			6.4pF	±0.5pF	GRM0115C1E6R4DE01#
			6.5pF	±0.5pF	GRM0115C1E6R5DE01#
			6.6pF	±0.5pF	GRM0115C1E6R6DE01#
			6.7pF	±0.5pF	GRM0115C1E6R7DE01#
			6.8pF	±0.5pF	GRM0115C1E6R8DE01#
			6.9pF	±0.5pF	GRM0115C1E6R9DE01#
			7.0pF	±0.5pF	GRM0115C1E7R0DE01#
			7.1pF	±0.5pF	GRM0115C1E7R1DE01#
			7.2pF	±0.5pF	GRM0115C1E7R2DE01#
			7.3pF	±0.5pF	GRM0115C1E7R3DE01#
			7.4pF	±0.5pF	GRM0115C1E7R4DE01#
			7.5pF	±0.5pF	GRM0115C1E7R5DE01#
			7.6pF	±0.5pF	GRM0115C1E7R6DE01#
			7.7pF	±0.5pF	GRM0115C1E7R7DE01#
			7.8pF	±0.5pF	GRM0115C1E7R8DE01#
			7.9pF	±0.5pF	GRM0115C1E7R9DE01#
			8.0pF	±0.5pF	GRM0115C1E8R0DE01#
			8.1pF	±0.5pF	GRM0115C1E8R1DE01#
			8.2pF	±0.5pF	GRM0115C1E8R2DE01#
			8.3pF	±0.5pF	GRM0115C1E8R3DE01#
			8.4pF	±0.5pF	GRM0115C1E8R4DE01#
			8.5pF	±0.5pF	GRM0115C1E8R5DE01#
			8.6pF	±0.5pF	GRM0115C1E8R6DE01#
			8.7pF	±0.5pF	GRM0115C1E8R7DE01#
			8.8pF	±0.5pF	GRM0115C1E8R8DE01#
			8.9pF	±0.5pF	GRM0115C1E8R9DE01#
			9.0pF	±0.5pF	GRM0115C1E9R0DE01#
			9.1pF	±0.5pF	GRM0115C1E9R1DE01#
			9.2pF	±0.5pF	GRM0115C1E9R2DE01#
			9.3pF	±0.5pF	GRM0115C1E9R3DE01#
			9.4pF	±0.5pF	GRM0115C1E9R4DE01#
			9.5pF	±0.5pF	GRM0115C1E9R5DE01#
			9.6pF	±0.5pF	GRM0115C1E9R6DE01#
			9.7pF	±0.5pF	GRM0115C1E9R7DE01#
			9.8pF	±0.5pF	GRM0115C1E9R8DE01#
			9.9pF	±0.5pF	GRM0115C1E9R9DE01#
			10pF	±5%	GRM0115C1E100JE01#
			11pF	±5%	GRM0115C1E110JE01#
			12pF	±5%	GRM0115C1E120JE01#
			13pF	±5%	GRM0115C1E130JE01#
			15pF	±5%	GRM0115C1E150JE01#
			16pF	±5%	GRM0115C1E160JE01#
			18pF	±5%	GRM0115C1E180JE01#
			20pF	±5%	GRM0115C1E200JE01#

- GRM
- GR3
- GRJ
- GR4
- GJM
- GQM
- GA2
- GA3 GB
- GA3 GD
- GA3 GF
- LLL
- LLA
- LLM
- LLR
- NFM
- KRM
- KR3
- GMA
- GMD
- ⚠Caution /Notice

Part number # indicates the package specification code.

GRM Series Temperature Compensating Type Part Number List

(→ 0.25×0.125mm)

T max.	Rated Voltage	TC Code	Cap.	Tol.	Part Number
0.138mm	25Vdc	COG	22pF	±5%	GRM0115C1E220JE01#
			24pF	±5%	GRM0115C1E240JE01#
			27pF	±5%	GRM0115C1E270JE01#
			30pF	±5%	GRM0115C1E300JE01#
			33pF	±5%	GRM0115C1E330JE01#
			36pF	±5%	GRM0115C1E360JE01#
			39pF	±5%	GRM0115C1E390JE01#
			43pF	±5%	GRM0115C1E430JE01#
			47pF	±5%	GRM0115C1E470JE01#
			51pF	±5%	GRM0115C1E510JE01#
			56pF	±5%	GRM0115C1E560JE01#
			62pF	±5%	GRM0115C1E620JE01#
			68pF	±5%	GRM0115C1E680JE01#
			75pF	±5%	GRM0115C1E750JE01#
			82pF	±5%	GRM0115C1E820JE01#
			91pF	±5%	GRM0115C1E910JE01#
			100pF	±5%	GRM0115C1E101JE01#
			16Vdc	COG	0.20pF
0.30pF	±0.1pF	GRM0115C1CR30BE11#			
0.40pF	±0.1pF	GRM0115C1CR40BE11#			
0.50pF	±0.1pF	GRM0115C1CR50BE11#			
0.60pF	±0.1pF	GRM0115C1CR60BE11#			
0.70pF	±0.1pF	GRM0115C1CR70BE11#			
0.80pF	±0.1pF	GRM0115C1CR80BE11#			
0.90pF	±0.1pF	GRM0115C1CR90BE11#			
1.0pF	±0.25pF	GRM0115C1C1R0CE11#			
1.1pF	±0.25pF	GRM0115C1C1R1CE11#			
1.2pF	±0.25pF	GRM0115C1C1R2CE11#			
1.3pF	±0.25pF	GRM0115C1C1R3CE11#			
1.4pF	±0.25pF	GRM0115C1C1R4CE11#			
1.5pF	±0.25pF	GRM0115C1C1R5CE11#			
1.6pF	±0.25pF	GRM0115C1C1R6CE11#			
1.7pF	±0.25pF	GRM0115C1C1R7CE11#			
1.8pF	±0.25pF	GRM0115C1C1R8CE11#			
1.9pF	±0.25pF	GRM0115C1C1R9CE11#			
2.0pF	±0.25pF	GRM0115C1C2R0CE11#			
2.1pF	±0.25pF	GRM0115C1C2R1CE11#			
2.2pF	±0.25pF	GRM0115C1C2R2CE11#			
2.3pF	±0.25pF	GRM0115C1C2R3CE11#			
11pF	±5%	GRM0115C1C110JE01#			
12pF	±5%	GRM0115C1C120JE01#			
13pF	±5%	GRM0115C1C130JE01#			
15pF	±5%	GRM0115C1C150JE01#			
16pF	±5%	GRM0115C1C160JE01#			
18pF	±5%	GRM0115C1C180JE01#			
20pF	±5%	GRM0115C1C200JE01#			
22pF	±5%	GRM0115C1C220JE01#			
24pF	±5%	GRM0115C1C240JE01#			
27pF	±5%	GRM0115C1C270JE01#			
30pF	±5%	GRM0115C1C300JE01#			
33pF	±5%	GRM0115C1C330JE01#			
36pF	±5%	GRM0115C1C360JE01#			
39pF	±5%	GRM0115C1C390JE01#			
43pF	±5%	GRM0115C1C430JE01#			

T max.	Rated Voltage	TC Code	Cap.	Tol.	Part Number
0.138mm	16Vdc	COG	47pF	±5%	GRM0115C1C470JE01#
			51pF	±5%	GRM0115C1C510JE01#
			56pF	±5%	GRM0115C1C560JE01#
			62pF	±5%	GRM0115C1C620JE01#
			68pF	±5%	GRM0115C1C680JE01#
			75pF	±5%	GRM0115C1C750JE01#
			82pF	±5%	GRM0115C1C820JE01#
			91pF	±5%	GRM0115C1C910JE01#
			100pF	±5%	GRM0115C1C101JE01#

0.4×0.2mm

T max.	Rated Voltage	TC Code	Cap.	Tol.	Part Number
0.22mm	50Vdc	COG	0.20pF	±0.1pF	GRM0225C1HR20BA03#
			0.30pF	±0.1pF	GRM0225C1HR30BA03#
			0.40pF	±0.1pF	GRM0225C1HR40BA03#
			0.50pF	±0.1pF	GRM0225C1HR50BA03#
			0.60pF	±0.1pF	GRM0225C1HR60BA03#
			0.70pF	±0.1pF	GRM0225C1HR70BA03#
			0.80pF	±0.1pF	GRM0225C1HR80BA03#
			0.90pF	±0.1pF	GRM0225C1HR90BA03#
			1.0pF	±0.25pF	GRM0225C1H1R0CA03#
			1.1pF	±0.25pF	GRM0225C1H1R1CA03#
			1.2pF	±0.25pF	GRM0225C1H1R2CA03#
			1.3pF	±0.25pF	GRM0225C1H1R3CA03#
			1.4pF	±0.25pF	GRM0225C1H1R4CA03#
			1.5pF	±0.25pF	GRM0225C1H1R5CA03#
			1.6pF	±0.25pF	GRM0225C1H1R6CA03#
			1.7pF	±0.25pF	GRM0225C1H1R7CA03#
			1.8pF	±0.25pF	GRM0225C1H1R8CA03#
			1.9pF	±0.25pF	GRM0225C1H1R9CA03#
			2.0pF	±0.25pF	GRM0225C1H2R0CA03#
			2.1pF	±0.25pF	GRM0225C1H2R1CA03#
			2.2pF	±0.25pF	GRM0225C1H2R2CA03#
			2.3pF	±0.25pF	GRM0225C1H2R3CA03#
			2.4pF	±0.25pF	GRM0225C1H2R4CA03#
			2.5pF	±0.25pF	GRM0225C1H2R5CA03#
			2.6pF	±0.25pF	GRM0225C1H2R6CA03#
			2.7pF	±0.25pF	GRM0225C1H2R7CA03#
			2.8pF	±0.25pF	GRM0225C1H2R8CA03#
			2.9pF	±0.25pF	GRM0225C1H2R9CA03#
			3.0pF	±0.25pF	GRM0225C1H3R0CA03#
			3.1pF	±0.25pF	GRM0225C1H3R1CA03#
			3.2pF	±0.25pF	GRM0225C1H3R2CA03#
			3.3pF	±0.25pF	GRM0225C1H3R3CA03#
			3.4pF	±0.25pF	GRM0225C1H3R4CA03#
			3.5pF	±0.25pF	GRM0225C1H3R5CA03#
			3.6pF	±0.25pF	GRM0225C1H3R6CA03#
			3.7pF	±0.25pF	GRM0225C1H3R7CA03#
			3.8pF	±0.25pF	GRM0225C1H3R8CA03#
			3.9pF	±0.25pF	GRM0225C1H3R9CA03#
			4.0pF	±0.25pF	GRM0225C1H4R0CA03#
			4.1pF	±0.25pF	GRM0225C1H4R1CA03#

Part number # indicates the package specification code.

GRM
 GR3
 GRJ
 GR4
 GJM
 GQM
 GA2
 GA3 GB
 GA3 GD
 GA3 GF
 LLL
 LLA
 LLM
 LLR
 NFM
 KRM
 KR3
 GMA
 GMD
 ⚠Caution / Notice

GRM Series Temperature Compensating Type Part Number List

(→ 0.4×0.2mm)

T max.	Rated Voltage	TC Code	Cap.	Tol.	Part Number	T max.	Rated Voltage	TC Code	Cap.	Tol.	Part Number	
0.22mm	50Vdc	COG	4.2pF	±0.25pF	GRM0225C1H4R2CA03#	0.22mm	50Vdc	COG	9.6pF	±0.5pF	GRM0225C1H9R6DA03#	
			4.3pF	±0.25pF	GRM0225C1H4R3CA03#				9.7pF	±0.5pF	GRM0225C1H9R7DA03#	
			4.4pF	±0.25pF	GRM0225C1H4R4CA03#				9.8pF	±0.5pF	GRM0225C1H9R8DA03#	
			4.5pF	±0.25pF	GRM0225C1H4R5CA03#				9.9pF	±0.5pF	GRM0225C1H9R9DA03#	
			4.6pF	±0.25pF	GRM0225C1H4R6CA03#				10pF	±5%	GRM0225C1H100JA03#	
			4.7pF	±0.25pF	GRM0225C1H4R7CA03#				11pF	±5%	GRM0225C1H110JA03#	
			4.8pF	±0.25pF	GRM0225C1H4R8CA03#				12pF	±5%	GRM0225C1H120JA03#	
			4.9pF	±0.25pF	GRM0225C1H4R9CA03#				13pF	±5%	GRM0225C1H130JA03#	
			5.0pF	±0.25pF	GRM0225C1H5R0CA03#				15pF	±5%	GRM0225C1H150JA03#	
			5.1pF	±0.5pF	GRM0225C1H5R1DA03#				16pF	±5%	GRM0225C1H160JA03#	
			5.2pF	±0.5pF	GRM0225C1H5R2DA03#				18pF	±5%	GRM0225C1H180JA02#	
			5.3pF	±0.5pF	GRM0225C1H5R3DA03#				20pF	±5%	GRM0225C1H200JA02#	
			5.4pF	±0.5pF	GRM0225C1H5R4DA03#				22pF	±5%	GRM0225C1H220JA02#	
			5.5pF	±0.5pF	GRM0225C1H5R5DA03#				24pF	±5%	GRM0225C1H240JA02#	
			5.6pF	±0.5pF	GRM0225C1H5R6DA03#				27pF	±5%	GRM0225C1H270JA02#	
			5.7pF	±0.5pF	GRM0225C1H5R7DA03#				30pF	±5%	GRM0225C1H300JA02#	
			5.8pF	±0.5pF	GRM0225C1H5R8DA03#				33pF	±5%	GRM0225C1H330JA02#	
			5.9pF	±0.5pF	GRM0225C1H5R9DA03#				36pF	±5%	GRM0225C1H360JA02#	
			6.0pF	±0.5pF	GRM0225C1H6R0DA03#				39pF	±5%	GRM0225C1H390JA02#	
			6.1pF	±0.5pF	GRM0225C1H6R1DA03#				43pF	±5%	GRM0225C1H430JA02#	
			6.2pF	±0.5pF	GRM0225C1H6R2DA03#				47pF	±5%	GRM0225C1H470JA02#	
			6.3pF	±0.5pF	GRM0225C1H6R3DA03#				51pF	±5%	GRM0225C1H510JA02#	
			6.4pF	±0.5pF	GRM0225C1H6R4DA03#				56pF	±5%	GRM0225C1H560JA02#	
			6.5pF	±0.5pF	GRM0225C1H6R5DA03#				62pF	±5%	GRM0225C1H620JA02#	
			6.6pF	±0.5pF	GRM0225C1H6R6DA03#				68pF	±5%	GRM0225C1H680JA02#	
			6.7pF	±0.5pF	GRM0225C1H6R7DA03#				75pF	±5%	GRM0225C1H750JA02#	
			6.8pF	±0.5pF	GRM0225C1H6R8DA03#				82pF	±5%	GRM0225C1H820JA02#	
			6.9pF	±0.5pF	GRM0225C1H6R9DA03#				91pF	±5%	GRM0225C1H910JA02#	
			7.0pF	±0.5pF	GRM0225C1H7R0DA03#				100pF	±5%	GRM0225C1H101JA02#	
			7.1pF	±0.5pF	GRM0225C1H7R1DA03#				CK	0.20pF	±0.1pF	GRM0224C1HR20BA03#
			7.2pF	±0.5pF	GRM0225C1H7R2DA03#					0.30pF	±0.1pF	GRM0224C1HR30BA03#
			7.3pF	±0.5pF	GRM0225C1H7R3DA03#					0.40pF	±0.1pF	GRM0224C1HR40BA03#
			7.4pF	±0.5pF	GRM0225C1H7R4DA03#					0.50pF	±0.1pF	GRM0224C1HR50BA03#
			7.5pF	±0.5pF	GRM0225C1H7R5DA03#					0.60pF	±0.1pF	GRM0224C1HR60BA03#
			7.6pF	±0.5pF	GRM0225C1H7R6DA03#					0.70pF	±0.1pF	GRM0224C1HR70BA03#
			7.7pF	±0.5pF	GRM0225C1H7R7DA03#					0.80pF	±0.1pF	GRM0224C1HR80BA03#
			7.8pF	±0.5pF	GRM0225C1H7R8DA03#					0.90pF	±0.1pF	GRM0224C1HR90BA03#
			7.9pF	±0.5pF	GRM0225C1H7R9DA03#					1.0pF	±0.25pF	GRM0224C1H1R0CA03#
			8.0pF	±0.5pF	GRM0225C1H8R0DA03#					1.1pF	±0.25pF	GRM0224C1H1R1CA03#
			8.1pF	±0.5pF	GRM0225C1H8R1DA03#				1.2pF	±0.25pF	GRM0224C1H1R2CA03#	
			8.2pF	±0.5pF	GRM0225C1H8R2DA03#				1.3pF	±0.25pF	GRM0224C1H1R3CA03#	
			8.3pF	±0.5pF	GRM0225C1H8R3DA03#				1.4pF	±0.25pF	GRM0224C1H1R4CA03#	
			8.4pF	±0.5pF	GRM0225C1H8R4DA03#				1.5pF	±0.25pF	GRM0224C1H1R5CA03#	
			8.5pF	±0.5pF	GRM0225C1H8R5DA03#				1.6pF	±0.25pF	GRM0224C1H1R6CA03#	
			8.6pF	±0.5pF	GRM0225C1H8R6DA03#				1.7pF	±0.25pF	GRM0224C1H1R7CA03#	
8.7pF	±0.5pF	GRM0225C1H8R7DA03#	1.8pF	±0.25pF	GRM0224C1H1R8CA03#							
8.8pF	±0.5pF	GRM0225C1H8R8DA03#	1.9pF	±0.25pF	GRM0224C1H1R9CA03#							
8.9pF	±0.5pF	GRM0225C1H8R9DA03#	2.0pF	±0.25pF	GRM0224C1H2R0CA03#							
9.0pF	±0.5pF	GRM0225C1H9R0DA03#	CJ	2.1pF	±0.25pF	GRM0223C1H2R1CA03#						
9.1pF	±0.5pF	GRM0225C1H9R1DA03#		2.2pF	±0.25pF	GRM0223C1H2R2CA03#						
9.2pF	±0.5pF	GRM0225C1H9R2DA03#		2.3pF	±0.25pF	GRM0223C1H2R3CA03#						
9.3pF	±0.5pF	GRM0225C1H9R3DA03#		2.4pF	±0.25pF	GRM0223C1H2R4CA03#						
9.4pF	±0.5pF	GRM0225C1H9R4DA03#		2.5pF	±0.25pF	GRM0223C1H2R5CA03#						
9.5pF	±0.5pF	GRM0225C1H9R5DA03#		2.6pF	±0.25pF	GRM0223C1H2R6CA03#						

Part number # indicates the package specification code.

⚠Caution /Notice

GRM
 GR3
 GRJ
 GR4
 GJM
 GQM
 GA2
 GA3 GB
 GA3 GD
 GA3 GF
 LLL
 LLA
 LLM
 LLR
 NFM
 KRM
 KR3
 GMA
 GMD

GRM Series Temperature Compensating Type Part Number List

(→ 0.4×0.2mm)

T max.	Rated Voltage	TC Code	Cap.	Tol.	Part Number	T max.	Rated Voltage	TC Code	Cap.	Tol.	Part Number
0.22mm	50Vdc	CJ	2.7pF	±0.25pF	GRM0223C1H2R7CA03#	0.22mm	50Vdc	CH	8.1pF	±0.5pF	GRM0222C1H8R1DA03#
			2.8pF	±0.25pF	GRM0223C1H2R8CA03#				8.2pF	±0.5pF	GRM0222C1H8R2DA03#
			2.9pF	±0.25pF	GRM0223C1H2R9CA03#				8.3pF	±0.5pF	GRM0222C1H8R3DA03#
			3.0pF	±0.25pF	GRM0223C1H3R0CA03#				8.4pF	±0.5pF	GRM0222C1H8R4DA03#
			3.1pF	±0.25pF	GRM0223C1H3R1CA03#				8.5pF	±0.5pF	GRM0222C1H8R5DA03#
			3.2pF	±0.25pF	GRM0223C1H3R2CA03#				8.6pF	±0.5pF	GRM0222C1H8R6DA03#
			3.3pF	±0.25pF	GRM0223C1H3R3CA03#				8.7pF	±0.5pF	GRM0222C1H8R7DA03#
			3.4pF	±0.25pF	GRM0223C1H3R4CA03#				8.8pF	±0.5pF	GRM0222C1H8R8DA03#
			3.5pF	±0.25pF	GRM0223C1H3R5CA03#				8.9pF	±0.5pF	GRM0222C1H8R9DA03#
			3.6pF	±0.25pF	GRM0223C1H3R6CA03#				9.0pF	±0.5pF	GRM0222C1H9R0DA03#
			3.7pF	±0.25pF	GRM0223C1H3R7CA03#				9.1pF	±0.5pF	GRM0222C1H9R1DA03#
			3.8pF	±0.25pF	GRM0223C1H3R8CA03#				9.2pF	±0.5pF	GRM0222C1H9R2DA03#
			3.9pF	±0.25pF	GRM0223C1H3R9CA03#				9.3pF	±0.5pF	GRM0222C1H9R3DA03#
		4.0pF	±0.25pF	GRM0222C1H4R0CA03#	9.4pF				±0.5pF	GRM0222C1H9R4DA03#	
		4.1pF	±0.25pF	GRM0222C1H4R1CA03#	9.5pF				±0.5pF	GRM0222C1H9R5DA03#	
		4.2pF	±0.25pF	GRM0222C1H4R2CA03#	9.6pF				±0.5pF	GRM0222C1H9R6DA03#	
		4.3pF	±0.25pF	GRM0222C1H4R3CA03#	9.7pF				±0.5pF	GRM0222C1H9R7DA03#	
		4.4pF	±0.25pF	GRM0222C1H4R4CA03#	9.8pF				±0.5pF	GRM0222C1H9R8DA03#	
		4.5pF	±0.25pF	GRM0222C1H4R5CA03#	9.9pF				±0.5pF	GRM0222C1H9R9DA03#	
		4.6pF	±0.25pF	GRM0222C1H4R6CA03#	10pF				±5%	GRM0222C1H100JA03#	
		4.7pF	±0.25pF	GRM0222C1H4R7CA03#	11pF				±5%	GRM0222C1H110JA03#	
		4.8pF	±0.25pF	GRM0222C1H4R8CA03#	12pF				±5%	GRM0222C1H120JA03#	
		4.9pF	±0.25pF	GRM0222C1H4R9CA03#	13pF				±5%	GRM0222C1H130JA03#	
		5.0pF	±0.25pF	GRM0222C1H5R0CA03#	15pF				±5%	GRM0222C1H150JA03#	
		5.1pF	±0.5pF	GRM0222C1H5R1DA03#	16pF				±5%	GRM0222C1H160JA03#	
		5.2pF	±0.5pF	GRM0222C1H5R2DA03#	18pF				±5%	GRM0222C1H180JA02#	
		5.3pF	±0.5pF	GRM0222C1H5R3DA03#	20pF				±5%	GRM0222C1H200JA02#	
		5.4pF	±0.5pF	GRM0222C1H5R4DA03#	22pF				±5%	GRM0222C1H220JA02#	
		5.5pF	±0.5pF	GRM0222C1H5R5DA03#	24pF				±5%	GRM0222C1H240JA02#	
		5.6pF	±0.5pF	GRM0222C1H5R6DA03#	27pF				±5%	GRM0222C1H270JA02#	
		5.7pF	±0.5pF	GRM0222C1H5R7DA03#	30pF				±5%	GRM0222C1H300JA02#	
		5.8pF	±0.5pF	GRM0222C1H5R8DA03#	33pF				±5%	GRM0222C1H330JA02#	
		5.9pF	±0.5pF	GRM0222C1H5R9DA03#	36pF				±5%	GRM0222C1H360JA02#	
		6.0pF	±0.5pF	GRM0222C1H6R0DA03#	39pF				±5%	GRM0222C1H390JA02#	
		6.1pF	±0.5pF	GRM0222C1H6R1DA03#	43pF				±5%	GRM0222C1H430JA02#	
		6.2pF	±0.5pF	GRM0222C1H6R2DA03#	47pF				±5%	GRM0222C1H470JA02#	
		6.3pF	±0.5pF	GRM0222C1H6R3DA03#	51pF				±5%	GRM0222C1H510JA02#	
		6.4pF	±0.5pF	GRM0222C1H6R4DA03#	56pF				±5%	GRM0222C1H560JA02#	
		6.5pF	±0.5pF	GRM0222C1H6R5DA03#	62pF				±5%	GRM0222C1H620JA02#	
		6.6pF	±0.5pF	GRM0222C1H6R6DA03#	68pF				±5%	GRM0222C1H680JA02#	
		6.7pF	±0.5pF	GRM0222C1H6R7DA03#	75pF				±5%	GRM0222C1H750JA02#	
		6.8pF	±0.5pF	GRM0222C1H6R8DA03#	82pF				±5%	GRM0222C1H820JA02#	
		6.9pF	±0.5pF	GRM0222C1H6R9DA03#	91pF				±5%	GRM0222C1H910JA02#	
		7.0pF	±0.5pF	GRM0222C1H7R0DA03#	100pF			±5%	GRM0222C1H101JA02#		
		7.1pF	±0.5pF	GRM0222C1H7R1DA03#	25Vdc			COG	120pF	±5%	GRM0225C1E121JA02#
		7.2pF	±0.5pF	GRM0222C1H7R2DA03#					150pF	±5%	GRM0225C1E151JA02#
		7.3pF	±0.5pF	GRM0222C1H7R3DA03#					180pF	±5%	GRM0225C1E181JA02#
		7.4pF	±0.5pF	GRM0222C1H7R4DA03#					220pF	±5%	GRM0225C1E221JA02#
		7.5pF	±0.5pF	GRM0222C1H7R5DA03#					CH	120pF	±5%
		7.6pF	±0.5pF	GRM0222C1H7R6DA03#	150pF			±5%		GRM0222C1E151JA02#	
		7.7pF	±0.5pF	GRM0222C1H7R7DA03#	180pF			±5%		GRM0222C1E181JA02#	
		7.8pF	±0.5pF	GRM0222C1H7R8DA03#	220pF			±5%		GRM0222C1E221JA02#	
7.9pF	±0.5pF	GRM0222C1H7R9DA03#	16Vdc	COG	120pF	±5%	GRM0225C1C121JA02#				
8.0pF	±0.5pF	GRM0222C1H8R0DA03#			150pF	±5%	GRM0225C1C151JA02#				

Part number # indicates the package specification code.



GRM Series Temperature Compensating Type Part Number List

(→ 0.4×0.2mm)

T max.	Rated Voltage	TC Code	Cap.	Tol.	Part Number
0.22mm	16Vdc	COG	180pF	±5%	GRM0225C1C181JA02#
			220pF	±5%	GRM0225C1C221JA02#
		CH	120pF	±5%	GRM0222C1C121JA02#
			150pF	±5%	GRM0222C1C151JA02#
			180pF	±5%	GRM0222C1C181JA02#
			220pF	±5%	GRM0222C1C221JA02#

T max.	Rated Voltage	TC Code	Cap.	Tol.	Part Number
0.33mm	100Vdc	COG	4.4pF	±0.25pF	GRM0335C2A4R4CA01#
			4.5pF	±0.25pF	GRM0335C2A4R5CA01#
			4.6pF	±0.25pF	GRM0335C2A4R6CA01#
			4.7pF	±0.25pF	GRM0335C2A4R7CA01#
			4.8pF	±0.25pF	GRM0335C2A4R8CA01#
			4.9pF	±0.25pF	GRM0335C2A4R9CA01#
			5.0pF	±0.25pF	GRM0335C2A5R0CA01#
			5.1pF	±0.5pF	GRM0335C2A5R1DA01#
			5.2pF	±0.5pF	GRM0335C2A5R2DA01#
			5.3pF	±0.5pF	GRM0335C2A5R3DA01#
			5.4pF	±0.5pF	GRM0335C2A5R4DA01#
			5.5pF	±0.5pF	GRM0335C2A5R5DA01#
			5.6pF	±0.5pF	GRM0335C2A5R6DA01#
			5.7pF	±0.5pF	GRM0335C2A5R7DA01#
			5.8pF	±0.5pF	GRM0335C2A5R8DA01#
			5.9pF	±0.5pF	GRM0335C2A5R9DA01#
			6.0pF	±0.5pF	GRM0335C2A6R0DA01#
			6.1pF	±0.5pF	GRM0335C2A6R1DA01#
			6.2pF	±0.5pF	GRM0335C2A6R2DA01#
			6.3pF	±0.5pF	GRM0335C2A6R3DA01#
			6.4pF	±0.5pF	GRM0335C2A6R4DA01#
			6.5pF	±0.5pF	GRM0335C2A6R5DA01#
			6.6pF	±0.5pF	GRM0335C2A6R6DA01#
			6.7pF	±0.5pF	GRM0335C2A6R7DA01#
			6.8pF	±0.5pF	GRM0335C2A6R8DA01#
			6.9pF	±0.5pF	GRM0335C2A6R9DA01#
			7.0pF	±0.5pF	GRM0335C2A7R0DA01#
7.1pF	±0.5pF	GRM0335C2A7R1DA01#			
7.2pF	±0.5pF	GRM0335C2A7R2DA01#			
7.3pF	±0.5pF	GRM0335C2A7R3DA01#			
7.4pF	±0.5pF	GRM0335C2A7R4DA01#			
7.5pF	±0.5pF	GRM0335C2A7R5DA01#			
7.6pF	±0.5pF	GRM0335C2A7R6DA01#			
7.7pF	±0.5pF	GRM0335C2A7R7DA01#			
7.8pF	±0.5pF	GRM0335C2A7R8DA01#			
7.9pF	±0.5pF	GRM0335C2A7R9DA01#			
8.0pF	±0.5pF	GRM0335C2A8R0DA01#			
8.1pF	±0.5pF	GRM0335C2A8R1DA01#			
8.2pF	±0.5pF	GRM0335C2A8R2DA01#			
8.3pF	±0.5pF	GRM0335C2A8R3DA01#			
8.4pF	±0.5pF	GRM0335C2A8R4DA01#			
8.5pF	±0.5pF	GRM0335C2A8R5DA01#			
8.6pF	±0.5pF	GRM0335C2A8R6DA01#			
8.7pF	±0.5pF	GRM0335C2A8R7DA01#			
8.8pF	±0.5pF	GRM0335C2A8R8DA01#			
8.9pF	±0.5pF	GRM0335C2A8R9DA01#			
9.0pF	±0.5pF	GRM0335C2A9R0DA01#			
9.1pF	±0.5pF	GRM0335C2A9R1DA01#			
9.2pF	±0.5pF	GRM0335C2A9R2DA01#			
9.3pF	±0.5pF	GRM0335C2A9R3DA01#			
9.4pF	±0.5pF	GRM0335C2A9R4DA01#			
9.5pF	±0.5pF	GRM0335C2A9R5DA01#			
9.6pF	±0.5pF	GRM0335C2A9R6DA01#			
9.7pF	±0.5pF	GRM0335C2A9R7DA01#			

0.6×0.3mm

T max.	Rated Voltage	TC Code	Cap.	Tol.	Part Number
0.33mm	100Vdc	COG	0.10pF	±0.05pF	GRM0335C2AR10WA01#
			0.20pF	±0.1pF	GRM0335C2AR20BA01#
			0.30pF	±0.1pF	GRM0335C2AR30BA01#
			0.40pF	±0.1pF	GRM0335C2AR40BA01#
			0.50pF	±0.1pF	GRM0335C2AR50BA01#
			0.60pF	±0.1pF	GRM0335C2AR60BA01#
			0.70pF	±0.1pF	GRM0335C2AR70BA01#
			0.80pF	±0.1pF	GRM0335C2AR80BA01#
			0.90pF	±0.1pF	GRM0335C2AR90BA01#
			1.0pF	±0.25pF	GRM0335C2A1R0CA01#
			1.1pF	±0.25pF	GRM0335C2A1R1CA01#
			1.2pF	±0.25pF	GRM0335C2A1R2CA01#
			1.3pF	±0.25pF	GRM0335C2A1R3CA01#
			1.4pF	±0.25pF	GRM0335C2A1R4CA01#
			1.5pF	±0.25pF	GRM0335C2A1R5CA01#
			1.6pF	±0.25pF	GRM0335C2A1R6CA01#
			1.7pF	±0.25pF	GRM0335C2A1R7CA01#
			1.8pF	±0.25pF	GRM0335C2A1R8CA01#
			1.9pF	±0.25pF	GRM0335C2A1R9CA01#
			2.0pF	±0.25pF	GRM0335C2A2R0CA01#
			2.1pF	±0.25pF	GRM0335C2A2R1CA01#
			2.2pF	±0.25pF	GRM0335C2A2R2CA01#
			2.3pF	±0.25pF	GRM0335C2A2R3CA01#
			2.4pF	±0.25pF	GRM0335C2A2R4CA01#
			2.5pF	±0.25pF	GRM0335C2A2R5CA01#
			2.6pF	±0.25pF	GRM0335C2A2R6CA01#
			2.7pF	±0.25pF	GRM0335C2A2R7CA01#
			2.8pF	±0.25pF	GRM0335C2A2R8CA01#
			2.9pF	±0.25pF	GRM0335C2A2R9CA01#
			3.0pF	±0.25pF	GRM0335C2A3R0CA01#
			3.1pF	±0.25pF	GRM0335C2A3R1CA01#
			3.2pF	±0.25pF	GRM0335C2A3R2CA01#
			3.3pF	±0.25pF	GRM0335C2A3R3CA01#
			3.4pF	±0.25pF	GRM0335C2A3R4CA01#
			3.5pF	±0.25pF	GRM0335C2A3R5CA01#
			3.6pF	±0.25pF	GRM0335C2A3R6CA01#
			3.7pF	±0.25pF	GRM0335C2A3R7CA01#
			3.8pF	±0.25pF	GRM0335C2A3R8CA01#
			3.9pF	±0.25pF	GRM0335C2A3R9CA01#
			4.0pF	±0.25pF	GRM0335C2A4R0CA01#
			4.1pF	±0.25pF	GRM0335C2A4R1CA01#
			4.2pF	±0.25pF	GRM0335C2A4R2CA01#
			4.3pF	±0.25pF	GRM0335C2A4R3CA01#

GRM
 GR3
 GRJ
 GR4
 GJM
 GQM
 GA2
 GA3 GB
 GA3 GD
 GA3 GF
 LLL
 LLA
 LLM
 LLR
 NFM
 KRM
 KR3
 GMA
 GMD
 ⚠Caution /Notice

Part number # indicates the package specification code.

GRM Series Temperature Compensating Type Part Number List

(→ 0.6×0.3mm)

T max.	Rated Voltage	TC Code	Cap.	Tol.	Part Number	T max.	Rated Voltage	TC Code	Cap.	Tol.	Part Number	
0.33mm	100Vdc	COG	9.8pF	±0.5pF	GRM0335C2A9R8DA01#	0.33mm	100Vdc	CJ	3.1pF	±0.25pF	GRM0333C2A3R1CA01#	
			9.9pF	±0.5pF	GRM0335C2A9R9DA01#				3.2pF	±0.25pF	GRM0333C2A3R2CA01#	
			10pF	±5%	GRM0335C2A100JA01#				3.3pF	±0.25pF	GRM0333C2A3R3CA01#	
			12pF	±5%	GRM0335C2A120JA01#				3.4pF	±0.25pF	GRM0333C2A3R4CA01#	
			15pF	±5%	GRM0335C2A150JA01#				3.5pF	±0.25pF	GRM0333C2A3R5CA01#	
			18pF	±5%	GRM0335C2A180JA01#				3.6pF	±0.25pF	GRM0333C2A3R6CA01#	
			20pF	±5%	GRM0335C2A200JA01#				3.7pF	±0.25pF	GRM0333C2A3R7CA01#	
			22pF	±5%	GRM0335C2A220JA01#				3.8pF	±0.25pF	GRM0333C2A3R8CA01#	
			24pF	±5%	GRM0335C2A240JA01#				3.9pF	±0.25pF	GRM0333C2A3R9CA01#	
			27pF	±5%	GRM0335C2A270JA01#				CH	4.0pF	±0.25pF	GRM0332C2A4R0CA01#
			30pF	±5%	GRM0335C2A300JA01#					4.1pF	±0.25pF	GRM0332C2A4R1CA01#
			33pF	±5%	GRM0335C2A330JA01#					4.2pF	±0.25pF	GRM0332C2A4R2CA01#
			36pF	±5%	GRM0335C2A360JA01#					4.3pF	±0.25pF	GRM0332C2A4R3CA01#
			39pF	±5%	GRM0335C2A390JA01#					4.4pF	±0.25pF	GRM0332C2A4R4CA01#
			43pF	±5%	GRM0335C2A430JA01#					4.5pF	±0.25pF	GRM0332C2A4R5CA01#
			47pF	±5%	GRM0335C2A470JA01#					4.6pF	±0.25pF	GRM0332C2A4R6CA01#
			51pF	±5%	GRM0335C2A510JA01#					4.7pF	±0.25pF	GRM0332C2A4R7CA01#
			56pF	±5%	GRM0335C2A560JA01#					4.8pF	±0.25pF	GRM0332C2A4R8CA01#
			62pF	±5%	GRM0335C2A620JA01#			4.9pF		±0.25pF	GRM0332C2A4R9CA01#	
			68pF	±5%	GRM0335C2A680JA01#			5.0pF		±0.25pF	GRM0332C2A5R0CA01#	
			75pF	±5%	GRM0335C2A750JA01#			5.1pF		±0.5pF	GRM0332C2A5R1DA01#	
			82pF	±5%	GRM0335C2A820JA01#			5.2pF		±0.5pF	GRM0332C2A5R2DA01#	
			91pF	±5%	GRM0335C2A910JA01#			5.3pF		±0.5pF	GRM0332C2A5R3DA01#	
			100pF	±5%	GRM0335C2A101JA01#			5.4pF		±0.5pF	GRM0332C2A5R4DA01#	
			CK	0.10pF	±0.05pF			GRM0334C2AR10WA01#		5.5pF	±0.5pF	GRM0332C2A5R5DA01#
				0.20pF	±0.1pF			GRM0334C2AR20BA01#		5.6pF	±0.5pF	GRM0332C2A5R6DA01#
				0.30pF	±0.1pF			GRM0334C2AR30BA01#		5.7pF	±0.5pF	GRM0332C2A5R7DA01#
				0.40pF	±0.1pF			GRM0334C2AR40BA01#	5.8pF	±0.5pF	GRM0332C2A5R8DA01#	
				0.50pF	±0.1pF			GRM0334C2AR50BA01#	5.9pF	±0.5pF	GRM0332C2A5R9DA01#	
				0.60pF	±0.1pF			GRM0334C2AR60BA01#	6.0pF	±0.5pF	GRM0332C2A6R0DA01#	
				0.70pF	±0.1pF			GRM0334C2AR70BA01#	6.1pF	±0.5pF	GRM0332C2A6R1DA01#	
				0.80pF	±0.1pF			GRM0334C2AR80BA01#	6.2pF	±0.5pF	GRM0332C2A6R2DA01#	
				0.90pF	±0.1pF			GRM0334C2AR90BA01#	6.3pF	±0.5pF	GRM0332C2A6R3DA01#	
				1.0pF	±0.25pF			GRM0334C2A1R0CA01#	6.4pF	±0.5pF	GRM0332C2A6R4DA01#	
				1.1pF	±0.25pF			GRM0334C2A1R1CA01#	6.5pF	±0.5pF	GRM0332C2A6R5DA01#	
				1.2pF	±0.25pF			GRM0334C2A1R2CA01#	6.6pF	±0.5pF	GRM0332C2A6R6DA01#	
		1.3pF		±0.25pF	GRM0334C2A1R3CA01#			6.7pF	±0.5pF	GRM0332C2A6R7DA01#		
		1.4pF		±0.25pF	GRM0334C2A1R4CA01#			6.8pF	±0.5pF	GRM0332C2A6R8DA01#		
		1.5pF		±0.25pF	GRM0334C2A1R5CA01#			6.9pF	±0.5pF	GRM0332C2A6R9DA01#		
		1.6pF		±0.25pF	GRM0334C2A1R6CA01#			7.0pF	±0.5pF	GRM0332C2A7R0DA01#		
		1.7pF		±0.25pF	GRM0334C2A1R7CA01#			7.1pF	±0.5pF	GRM0332C2A7R1DA01#		
		1.8pF		±0.25pF	GRM0334C2A1R8CA01#			7.2pF	±0.5pF	GRM0332C2A7R2DA01#		
		1.9pF		±0.25pF	GRM0334C2A1R9CA01#			7.3pF	±0.5pF	GRM0332C2A7R3DA01#		
		2.0pF		±0.25pF	GRM0334C2A2R0CA01#			7.4pF	±0.5pF	GRM0332C2A7R4DA01#		
		CJ		2.1pF	±0.25pF			GRM0333C2A2R1CA01#	7.5pF	±0.5pF	GRM0332C2A7R5DA01#	
				2.2pF	±0.25pF			GRM0333C2A2R2CA01#	7.6pF	±0.5pF	GRM0332C2A7R6DA01#	
				2.3pF	±0.25pF			GRM0333C2A2R3CA01#	7.7pF	±0.5pF	GRM0332C2A7R7DA01#	
				2.4pF	±0.25pF			GRM0333C2A2R4CA01#	7.8pF	±0.5pF	GRM0332C2A7R8DA01#	
				2.5pF	±0.25pF			GRM0333C2A2R5CA01#	7.9pF	±0.5pF	GRM0332C2A7R9DA01#	
				2.6pF	±0.25pF			GRM0333C2A2R6CA01#	8.0pF	±0.5pF	GRM0332C2A8R0DA01#	
				2.7pF	±0.25pF			GRM0333C2A2R7CA01#	8.1pF	±0.5pF	GRM0332C2A8R1DA01#	
				2.8pF	±0.25pF			GRM0333C2A2R8CA01#	8.2pF	±0.5pF	GRM0332C2A8R2DA01#	
				2.9pF	±0.25pF			GRM0333C2A2R9CA01#	8.3pF	±0.5pF	GRM0332C2A8R3DA01#	
				3.0pF	±0.25pF			GRM0333C2A3R0CA01#	8.4pF	±0.5pF	GRM0332C2A8R4DA01#	

Part number # indicates the package specification code.

⚠Caution / Notice

GRM
 GR3
 GRJ
 GR4
 GJM
 GQM
 GA2
 GA3 GB
 GA3 GD
 GA3 GF
 LLL
 LLA
 LLM
 LLR
 NFM
 KRM
 KR3
 GMA
 GMD

GRM Series Temperature Compensating Type Part Number List

(→ 0.6×0.3mm)

T max.	Rated Voltage	TC Code	Cap.	Tol.	Part Number	T max.	Rated Voltage	TC Code	Cap.	Tol.	Part Number		
0.33mm	100Vdc	CH	8.5pF	±0.5pF	GRM0332C2A8R5DA01#	0.33mm	50Vdc	COG	1.8pF	±0.25pF	GRM0335C1H1R8CA01#		
			8.6pF	±0.5pF	GRM0332C2A8R6DA01#				1.9pF	±0.25pF	GRM0335C1H1R9CA01#		
			8.7pF	±0.5pF	GRM0332C2A8R7DA01#				2.0pF	±0.25pF	GRM0335C1H2R0CA01#		
			8.8pF	±0.5pF	GRM0332C2A8R8DA01#				2.1pF	±0.25pF	GRM0335C1H2R1CA01#		
			8.9pF	±0.5pF	GRM0332C2A8R9DA01#				2.2pF	±0.25pF	GRM0335C1H2R2CA01#		
			9.0pF	±0.5pF	GRM0332C2A9R0DA01#				2.3pF	±0.25pF	GRM0335C1H2R3CA01#		
			9.1pF	±0.5pF	GRM0332C2A9R1DA01#				2.4pF	±0.25pF	GRM0335C1H2R4CA01#		
			9.2pF	±0.5pF	GRM0332C2A9R2DA01#				2.5pF	±0.25pF	GRM0335C1H2R5CA01#		
			9.3pF	±0.5pF	GRM0332C2A9R3DA01#				2.6pF	±0.25pF	GRM0335C1H2R6CA01#		
			9.4pF	±0.5pF	GRM0332C2A9R4DA01#				2.7pF	±0.25pF	GRM0335C1H2R7CA01#		
			9.5pF	±0.5pF	GRM0332C2A9R5DA01#				2.8pF	±0.25pF	GRM0335C1H2R8CA01#		
			9.6pF	±0.5pF	GRM0332C2A9R6DA01#				2.9pF	±0.25pF	GRM0335C1H2R9CA01#		
			9.7pF	±0.5pF	GRM0332C2A9R7DA01#				3.0pF	±0.25pF	GRM0335C1H3R0CA01#		
			9.8pF	±0.5pF	GRM0332C2A9R8DA01#				3.1pF	±0.25pF	GRM0335C1H3R1CA01#		
			9.9pF	±0.5pF	GRM0332C2A9R9DA01#				3.2pF	±0.25pF	GRM0335C1H3R2CA01#		
			10pF	±5%	GRM0332C2A100JA01#				3.3pF	±0.25pF	GRM0335C1H3R3CA01#		
			12pF	±5%	GRM0332C2A120JA01#				3.4pF	±0.25pF	GRM0335C1H3R4CA01#		
			15pF	±5%	GRM0332C2A150JA01#				3.5pF	±0.25pF	GRM0335C1H3R5CA01#		
			18pF	±5%	GRM0332C2A180JA01#				3.6pF	±0.25pF	GRM0335C1H3R6CA01#		
			20pF	±5%	GRM0332C2A200JA01#				3.7pF	±0.25pF	GRM0335C1H3R7CA01#		
			22pF	±5%	GRM0332C2A220JA01#				3.8pF	±0.25pF	GRM0335C1H3R8CA01#		
			24pF	±5%	GRM0332C2A240JA01#				3.9pF	±0.25pF	GRM0335C1H3R9CA01#		
			27pF	±5%	GRM0332C2A270JA01#				4.0pF	±0.25pF	GRM0335C1H4R0CA01#		
			30pF	±5%	GRM0332C2A300JA01#				4.1pF	±0.25pF	GRM0335C1H4R1CA01#		
			33pF	±5%	GRM0332C2A330JA01#				4.2pF	±0.25pF	GRM0335C1H4R2CA01#		
			36pF	±5%	GRM0332C2A360JA01#				4.3pF	±0.25pF	GRM0335C1H4R3CA01#		
			39pF	±5%	GRM0332C2A390JA01#				4.4pF	±0.25pF	GRM0335C1H4R4CA01#		
			43pF	±5%	GRM0332C2A430JA01#				4.5pF	±0.25pF	GRM0335C1H4R5CA01#		
			47pF	±5%	GRM0332C2A470JA01#				4.6pF	±0.25pF	GRM0335C1H4R6CA01#		
			51pF	±5%	GRM0332C2A510JA01#				4.7pF	±0.25pF	GRM0335C1H4R7CA01#		
			56pF	±5%	GRM0332C2A560JA01#				4.8pF	±0.25pF	GRM0335C1H4R8CA01#		
			62pF	±5%	GRM0332C2A620JA01#				4.9pF	±0.25pF	GRM0335C1H4R9CA01#		
			68pF	±5%	GRM0332C2A680JA01#				5.0pF	±0.25pF	GRM0335C1H5R0CA01#		
			75pF	±5%	GRM0332C2A750JA01#				5.1pF	±0.5pF	GRM0335C1H5R1DA01#		
			82pF	±5%	GRM0332C2A820JA01#				5.2pF	±0.5pF	GRM0335C1H5R2DA01#		
			91pF	±5%	GRM0332C2A910JA01#				5.3pF	±0.5pF	GRM0335C1H5R3DA01#		
			100pF	±5%	GRM0332C2A101JA01#				5.4pF	±0.5pF	GRM0335C1H5R4DA01#		
			50Vdc	COG	0.10pF				±0.05pF	GRM0335C1HR10WA01#	5.5pF	±0.5pF	GRM0335C1H5R5DA01#
					0.20pF				±0.1pF	GRM0335C1HR20BA01#	5.6pF	±0.5pF	GRM0335C1H5R6DA01#
					0.30pF				±0.1pF	GRM0335C1HR30BA01#	5.7pF	±0.5pF	GRM0335C1H5R7DA01#
0.40pF	±0.1pF	GRM0335C1HR40BA01#			5.8pF	±0.5pF	GRM0335C1H5R8DA01#						
0.50pF	±0.1pF	GRM0335C1HR50BA01#			5.9pF	±0.5pF	GRM0335C1H5R9DA01#						
0.60pF	±0.1pF	GRM0335C1HR60BA01#			6.0pF	±0.5pF	GRM0335C1H6R0DA01#						
0.70pF	±0.1pF	GRM0335C1HR70BA01#			6.1pF	±0.5pF	GRM0335C1H6R1DA01#						
0.80pF	±0.1pF	GRM0335C1HR80BA01#			6.2pF	±0.5pF	GRM0335C1H6R2DA01#						
0.90pF	±0.1pF	GRM0335C1HR90BA01#			6.3pF	±0.5pF	GRM0335C1H6R3DA01#						
1.0pF	±0.25pF	GRM0335C1H1R0CA01#			6.4pF	±0.5pF	GRM0335C1H6R4DA01#						
1.1pF	±0.25pF	GRM0335C1H1R1CA01#			6.5pF	±0.5pF	GRM0335C1H6R5DA01#						
1.2pF	±0.25pF	GRM0335C1H1R2CA01#			6.6pF	±0.5pF	GRM0335C1H6R6DA01#						
1.3pF	±0.25pF	GRM0335C1H1R3CA01#			6.7pF	±0.5pF	GRM0335C1H6R7DA01#						
1.4pF	±0.25pF	GRM0335C1H1R4CA01#			6.8pF	±0.5pF	GRM0335C1H6R8DA01#						
1.5pF	±0.25pF	GRM0335C1H1R5CA01#			6.9pF	±0.5pF	GRM0335C1H6R9DA01#						
1.6pF	±0.25pF	GRM0335C1H1R6CA01#			7.0pF	±0.5pF	GRM0335C1H7R0DA01#						
1.7pF	±0.25pF	GRM0335C1H1R7CA01#			7.1pF	±0.5pF	GRM0335C1H7R1DA01#						

Part number # indicates the package specification code.

⚠Caution / Notice

GRM
 GR3
 GRJ
 GR4
 GJM
 GQM
 GA2
 GA3 GB
 GA3 GD
 GA3 GF
 LLL
 LLA
 LLM
 LLR
 NFM
 KRM
 KR3
 GMA
 GMD

GRM Series Temperature Compensating Type Part Number List

(→ 0.6×0.3mm)

T max.	Rated Voltage	TC Code	Cap.	Tol.	Part Number	T max.	Rated Voltage	TC Code	Cap.	Tol.	Part Number	
0.33mm	50Vdc	COG	7.2pF	±0.5pF	GRM0335C1H7R2DA01#	0.33mm	50Vdc	CK	1.0pF	±0.25pF	GRM0334C1H1R0CA01#	
			7.3pF	±0.5pF	GRM0335C1H7R3DA01#				1.1pF	±0.25pF	GRM0334C1H1R1CA01#	
			7.4pF	±0.5pF	GRM0335C1H7R4DA01#				1.2pF	±0.25pF	GRM0334C1H1R2CA01#	
			7.5pF	±0.5pF	GRM0335C1H7R5DA01#				1.3pF	±0.25pF	GRM0334C1H1R3CA01#	
			7.6pF	±0.5pF	GRM0335C1H7R6DA01#				1.4pF	±0.25pF	GRM0334C1H1R4CA01#	
			7.7pF	±0.5pF	GRM0335C1H7R7DA01#				1.5pF	±0.25pF	GRM0334C1H1R5CA01#	
			7.8pF	±0.5pF	GRM0335C1H7R8DA01#				1.6pF	±0.25pF	GRM0334C1H1R6CA01#	
			7.9pF	±0.5pF	GRM0335C1H7R9DA01#				1.7pF	±0.25pF	GRM0334C1H1R7CA01#	
			8.0pF	±0.5pF	GRM0335C1H8R0DA01#				1.8pF	±0.25pF	GRM0334C1H1R8CA01#	
			8.1pF	±0.5pF	GRM0335C1H8R1DA01#				1.9pF	±0.25pF	GRM0334C1H1R9CA01#	
			8.2pF	±0.5pF	GRM0335C1H8R2DA01#				2.0pF	±0.25pF	GRM0334C1H2R0CA01#	
			8.3pF	±0.5pF	GRM0335C1H8R3DA01#				CJ	2.1pF	±0.25pF	GRM0333C1H2R1CA01#
			8.4pF	±0.5pF	GRM0335C1H8R4DA01#					2.2pF	±0.25pF	GRM0333C1H2R2CA01#
			8.5pF	±0.5pF	GRM0335C1H8R5DA01#					2.3pF	±0.25pF	GRM0333C1H2R3CA01#
			8.6pF	±0.5pF	GRM0335C1H8R6DA01#					2.4pF	±0.25pF	GRM0333C1H2R4CA01#
			8.7pF	±0.5pF	GRM0335C1H8R7DA01#					2.5pF	±0.25pF	GRM0333C1H2R5CA01#
			8.8pF	±0.5pF	GRM0335C1H8R8DA01#					2.6pF	±0.25pF	GRM0333C1H2R6CA01#
			8.9pF	±0.5pF	GRM0335C1H8R9DA01#					2.7pF	±0.25pF	GRM0333C1H2R7CA01#
			9.0pF	±0.5pF	GRM0335C1H9R0DA01#					2.8pF	±0.25pF	GRM0333C1H2R8CA01#
			9.1pF	±0.5pF	GRM0335C1H9R1DA01#					2.9pF	±0.25pF	GRM0333C1H2R9CA01#
			9.2pF	±0.5pF	GRM0335C1H9R2DA01#			3.0pF		±0.25pF	GRM0333C1H3R0CA01#	
			9.3pF	±0.5pF	GRM0335C1H9R3DA01#			3.1pF		±0.25pF	GRM0333C1H3R1CA01#	
			9.4pF	±0.5pF	GRM0335C1H9R4DA01#			3.2pF		±0.25pF	GRM0333C1H3R2CA01#	
			9.5pF	±0.5pF	GRM0335C1H9R5DA01#			3.3pF		±0.25pF	GRM0333C1H3R3CA01#	
			9.6pF	±0.5pF	GRM0335C1H9R6DA01#			3.4pF		±0.25pF	GRM0333C1H3R4CA01#	
			9.7pF	±0.5pF	GRM0335C1H9R7DA01#			3.5pF		±0.25pF	GRM0333C1H3R5CA01#	
			9.8pF	±0.5pF	GRM0335C1H9R8DA01#			3.6pF		±0.25pF	GRM0333C1H3R6CA01#	
			9.9pF	±0.5pF	GRM0335C1H9R9DA01#			3.7pF		±0.25pF	GRM0333C1H3R7CA01#	
			10pF	±5%	GRM0335C1H100JA01#			3.8pF		±0.25pF	GRM0333C1H3R8CA01#	
			12pF	±5%	GRM0335C1H120JA01#			3.9pF		±0.25pF	GRM0333C1H3R9CA01#	
			15pF	±5%	GRM0335C1H150JA01#			CH		4.0pF	±0.25pF	GRM0332C1H4R0CA01#
			18pF	±5%	GRM0335C1H180JA01#				4.1pF	±0.25pF	GRM0332C1H4R1CA01#	
			22pF	±5%	GRM0335C1H220JA01#				4.2pF	±0.25pF	GRM0332C1H4R2CA01#	
			27pF	±5%	GRM0335C1H270JA01#				4.3pF	±0.25pF	GRM0332C1H4R3CA01#	
			33pF	±5%	GRM0335C1H330JA01#				4.4pF	±0.25pF	GRM0332C1H4R4CA01#	
			39pF	±5%	GRM0335C1H390JA01#				4.5pF	±0.25pF	GRM0332C1H4R5CA01#	
			47pF	±5%	GRM0335C1H470JA01#				4.6pF	±0.25pF	GRM0332C1H4R6CA01#	
			56pF	±5%	GRM0335C1H560JA01#				4.7pF	±0.25pF	GRM0332C1H4R7CA01#	
			68pF	±5%	GRM0335C1H680JA01#				4.8pF	±0.25pF	GRM0332C1H4R8CA01#	
			82pF	±5%	GRM0335C1H820JA01#				4.9pF	±0.25pF	GRM0332C1H4R9CA01#	
			100pF	±5%	GRM0335C1H101JA01#				5.0pF	±0.25pF	GRM0332C1H5R0CA01#	
			120pF	±5%	GRM0335C1H121JA01#				5.1pF	±0.5pF	GRM0332C1H5R1DA01#	
			150pF	±5%	GRM0335C1H151JA01#				5.2pF	±0.5pF	GRM0332C1H5R2DA01#	
			180pF	±5%	GRM0335C1H181JA01#			5.3pF	±0.5pF	GRM0332C1H5R3DA01#		
			220pF	±5%	GRM0335C1H221JA01#			5.4pF	±0.5pF	GRM0332C1H5R4DA01#		
			CK	0.10pF	±0.05pF			GRM0334C1HR10WA01#	5.5pF	±0.5pF	GRM0332C1H5R5DA01#	
				0.20pF	±0.1pF			GRM0334C1HR20BA01#	5.6pF	±0.5pF	GRM0332C1H5R6DA01#	
				0.30pF	±0.1pF			GRM0334C1HR30BA01#	5.7pF	±0.5pF	GRM0332C1H5R7DA01#	
				0.40pF	±0.1pF			GRM0334C1HR40BA01#	5.8pF	±0.5pF	GRM0332C1H5R8DA01#	
				0.50pF	±0.1pF			GRM0334C1HR50BA01#	5.9pF	±0.5pF	GRM0332C1H5R9DA01#	
0.60pF	±0.1pF	GRM0334C1HR60BA01#		6.0pF	±0.5pF	GRM0332C1H6R0DA01#						
0.70pF	±0.1pF	GRM0334C1HR70BA01#		6.1pF	±0.5pF	GRM0332C1H6R1DA01#						
0.80pF	±0.1pF	GRM0334C1HR80BA01#		6.2pF	±0.5pF	GRM0332C1H6R2DA01#						
0.90pF	±0.1pF	GRM0334C1HR90BA01#		6.3pF	±0.5pF	GRM0332C1H6R3DA01#						

Part number # indicates the package specification code.

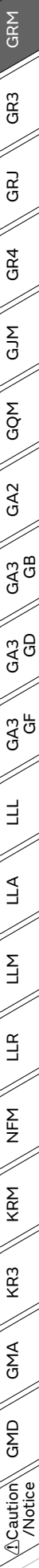

GRM Series Temperature Compensating Type Part Number List

(→ 0.6×0.3mm)

T max.	Rated Voltage	TC Code	Cap.	Tol.	Part Number
0.33mm	50Vdc	CH	6.4pF	±0.5pF	GRM0332C1H6R4DA01#
			6.5pF	±0.5pF	GRM0332C1H6R5DA01#
			6.6pF	±0.5pF	GRM0332C1H6R6DA01#
			6.7pF	±0.5pF	GRM0332C1H6R7DA01#
			6.8pF	±0.5pF	GRM0332C1H6R8DA01#
			6.9pF	±0.5pF	GRM0332C1H6R9DA01#
			7.0pF	±0.5pF	GRM0332C1H7R0DA01#
			7.1pF	±0.5pF	GRM0332C1H7R1DA01#
			7.2pF	±0.5pF	GRM0332C1H7R2DA01#
			7.3pF	±0.5pF	GRM0332C1H7R3DA01#
			7.4pF	±0.5pF	GRM0332C1H7R4DA01#
			7.5pF	±0.5pF	GRM0332C1H7R5DA01#
			7.6pF	±0.5pF	GRM0332C1H7R6DA01#
			7.7pF	±0.5pF	GRM0332C1H7R7DA01#
			7.8pF	±0.5pF	GRM0332C1H7R8DA01#
			7.9pF	±0.5pF	GRM0332C1H7R9DA01#
			8.0pF	±0.5pF	GRM0332C1H8R0DA01#
			8.1pF	±0.5pF	GRM0332C1H8R1DA01#
			8.2pF	±0.5pF	GRM0332C1H8R2DA01#
			8.3pF	±0.5pF	GRM0332C1H8R3DA01#
			8.4pF	±0.5pF	GRM0332C1H8R4DA01#
			8.5pF	±0.5pF	GRM0332C1H8R5DA01#
			8.6pF	±0.5pF	GRM0332C1H8R6DA01#
			8.7pF	±0.5pF	GRM0332C1H8R7DA01#
			8.8pF	±0.5pF	GRM0332C1H8R8DA01#
			8.9pF	±0.5pF	GRM0332C1H8R9DA01#
			9.0pF	±0.5pF	GRM0332C1H9R0DA01#
			9.1pF	±0.5pF	GRM0332C1H9R1DA01#
			9.2pF	±0.5pF	GRM0332C1H9R2DA01#
			9.3pF	±0.5pF	GRM0332C1H9R3DA01#
			9.4pF	±0.5pF	GRM0332C1H9R4DA01#
			9.5pF	±0.5pF	GRM0332C1H9R5DA01#
			9.6pF	±0.5pF	GRM0332C1H9R6DA01#
			9.7pF	±0.5pF	GRM0332C1H9R7DA01#
			9.8pF	±0.5pF	GRM0332C1H9R8DA01#
			9.9pF	±0.5pF	GRM0332C1H9R9DA01#
			10pF	±5%	GRM0332C1H100JA01#
			12pF	±5%	GRM0332C1H120JA01#
			15pF	±5%	GRM0332C1H150JA01#
			18pF	±5%	GRM0332C1H180JA01#
			22pF	±5%	GRM0332C1H220JA01#
			27pF	±5%	GRM0332C1H270JA01#
33pF	±5%	GRM0332C1H330JA01#			
39pF	±5%	GRM0332C1H390JA01#			
47pF	±5%	GRM0332C1H470JA01#			
56pF	±5%	GRM0332C1H560JA01#			
68pF	±5%	GRM0332C1H680JA01#			
82pF	±5%	GRM0332C1H820JA01#			
100pF	±5%	GRM0332C1H101JA01#			
120pF	±5%	GRM0332C1H121JA01#			
150pF	±5%	GRM0332C1H151JA01#			
180pF	±5%	GRM0332C1H181JA01#			
220pF	±5%	GRM0332C1H221JA01#			
25Vdc	COG	270pF	±5%	GRM0335C1E271JA01#	

T max.	Rated Voltage	TC Code	Cap.	Tol.	Part Number	
0.33mm	25Vdc	COG	330pF	±5%	GRM0335C1E331JA01#	
			390pF	±5%	GRM0335C1E391JA01#	
			470pF	±5%	GRM0335C1E471JA01#	
			560pF	±5%	GRM0335C1E561JA01#	
			680pF	±5%	GRM0335C1E681JA01#	
			820pF	±5%	GRM0335C1E821JA01#	
			910pF	±5%	GRM0335C1E911JA01#	
			1000pF	±5%	GRM0335C1E102JA01#	
			CH	270pF	±5%	GRM0332C1E271JA01#
				330pF	±5%	GRM0332C1E331JA01#
		390pF		±5%	GRM0332C1E391JA01#	
		470pF		±5%	GRM0332C1E471JA01#	
		560pF		±5%	GRM0332C1E561JA01#	
		680pF		±5%	GRM0332C1E681JA01#	
		820pF		±5%	GRM0332C1E821JA01#	
		1000pF		±5%	GRM0332C1E102JA01#	

1.0×0.5mm

T max.	Rated Voltage	TC Code	Cap.	Tol.	Part Number		
0.55mm	100Vdc	COG	150pF	±5%	GRM1555C2A151JE01#		
			220pF	±5%	GRM1555C2A221JE01#		
			330pF	±5%	GRM1555C2A331JE01#		
			470pF	±5%	GRM1555C2A471JE01#		
			680pF	±5%	GRM1555C2A681JE01#		
			1000pF	±5%	GRM1555C2A102JE01#		
			50Vdc	COG	270pF	±5%	GRM1555C1H271JA01#
					330pF	±5%	GRM1555C1H331JA01#
					390pF	±5%	GRM1555C1H391JA01#
					470pF	±5%	GRM1555C1H471JA01#
		560pF			±5%	GRM1555C1H561JA01#	
		680pF			±5%	GRM1555C1H681JA01#	
		820pF			±5%	GRM1555C1H821JA01#	
		1000pF			±5%	GRM1555C1H102JA01#	
		1200pF			±5%	GRM1555C1H122JA01#	
		1500pF			±5%	GRM1555C1H152JA01#	
		1800pF			±5%	GRM1555C1H182JA01#	
		10Vdc	U2J	270pF	±5%	GRM1557U1A272JA01#	
				330pF	±5%	GRM1557U1A332JA01#	
				390pF	±5%	GRM1557U1A392JA01#	
				470pF	±5%	GRM1557U1A472JA01#	
	560pF			±5%	GRM1557U1A562JA01#		
	680pF			±5%	GRM1557U1A682JA01#		
	UJ		2700pF	±5%	GRM1553U1A272JA01#		
			3300pF	±5%	GRM1553U1A332JA01#		
			3900pF	±5%	GRM1553U1A392JA01#		
			4700pF	±5%	GRM1553U1A472JA01#		
			3300pF	±5%	GRM1553U1A332JA01#		

Part number # indicates the package specification code.

GRM
 GR3
 GRJ
 GR4
 GJM
 GQM
 GA2
 GA3 GB
 GA3 GD
 GA3 GF
 LLL
 LLA
 LLM
 LLR
 NFM
 KRM
 KR3
 GMA
 GMD
 ⚠Caution /Notice

GRM Series Temperature Compensating Type Part Number List

(→ 1.0×0.5mm)

T max.	Rated Voltage	TC Code	Cap.	Tol.	Part Number
0.55mm	10Vdc	UJ	3900pF	±5%	GRM1553U1A392JA01#
			4700pF	±5%	GRM1553U1A472JA01#
0.65mm	50Vdc	COG	4700pF	±5%	GRM1555C1H472JE01#
			6800pF	±5%	GRM1555C1H682JE01#
	35Vdc	COG	10000pF	±5%	GRM1555CYA103JE01#
			25Vdc	COG	10000pF

1.6×0.8mm

T max.	Rated Voltage	TC Code	Cap.	Tol.	Part Number		
0.5mm	50Vdc	U2J	2200pF	±5%	GRM1857U1H222JA44#		
			2700pF	±5%	GRM1857U1H272JA44#		
			3300pF	±5%	GRM1857U1H332JA44#		
			3900pF	±5%	GRM1857U1H392JA44#		
			4700pF	±5%	GRM1857U1H472JA44#		
		UJ	2200pF	±5%	GRM1853U1H222JA44#		
			2700pF	±5%	GRM1853U1H272JA44#		
			3300pF	±5%	GRM1853U1H332JA44#		
			3900pF	±5%	GRM1853U1H392JA44#		
			4700pF	±5%	GRM1853U1H472JA44#		
	10Vdc	U2J	5600pF	±5%	GRM1857U1A562JA44#		
			6800pF	±5%	GRM1857U1A682JA44#		
			8200pF	±5%	GRM1857U1A822JA44#		
			10000pF	±5%	GRM1857U1A103JA44#		
			UJ	5600pF	±5%	GRM1853U1A562JA44#	
		6800pF		±5%	GRM1853U1A682JA44#		
		8200pF		±5%	GRM1853U1A822JA44#		
		10000pF		±5%	GRM1853U1A103JA44#		
		0.9mm		250Vdc	COG	10pF	±5%
			15pF			±5%	GRM1885C2E150JW07#
22pF	±5%		GRM1885C2E220JW07#				
33pF	±5%		GRM1885C2E330JW07#				
47pF	±5%		GRM1885C2E470JW07#				
100Vdc	COG		1000pF	±5%	GRM1885C2A102JA01#		
			1200pF	±5%	GRM1885C2A122JA01#		
			1500pF	±5%	GRM1885C2A152JA01#		
			1800pF	±5%	GRM1885C2A182JA01#		
			2200pF	±5%	GRM1885C2A222JA01#		
		2700pF	±5%	GRM1885C2A272JA01#			
		3300pF	±5%	GRM1885C2A332JA01#			
		3900pF	±5%	GRM1885C2A392JA01#			
		CH	1000pF	±5%	GRM1882C2A102JA01#		
			1200pF	±5%	GRM1882C2A122JA01#		
	1500pF		±5%	GRM1882C2A152JA01#			
	1800pF		±5%	GRM1882C2A182JA01#			
	2200pF		±5%	GRM1882C2A222JA01#			
	50Vdc	COG	1000pF	±5%	GRM1885C1H102JA01#		
			1200pF	±5%	GRM1885C1H122JA01#		
1500pF			±5%	GRM1885C1H152JA01#			
1800pF			±5%	GRM1885C1H182JA01#			

T max.	Rated Voltage	TC Code	Cap.	Tol.	Part Number	
0.9mm	50Vdc	COG	2200pF	±5%	GRM1885C1H222JA01#	
			2700pF	±5%	GRM1885C1H272JA01#	
			3300pF	±5%	GRM1885C1H332JA01#	
			3900pF	±5%	GRM1885C1H392JA01#	
			4700pF	±5%	GRM1885C1H472JA01#	
			5600pF	±5%	GRM1885C1H562JA01#	
			6800pF	±5%	GRM1885C1H682JA01#	
			8200pF	±5%	GRM1885C1H822JA01#	
			10000pF	±5%	GRM1885C1H103JA01#	
			CH	1000pF	±5%	GRM1882C1H102JA01#
				1200pF	±5%	GRM1882C1H122JA01#
				1500pF	±5%	GRM1882C1H152JA01#
				1800pF	±5%	GRM1882C1H182JA01#
				2200pF	±5%	GRM1882C1H222JA01#
				2700pF	±5%	GRM1882C1H272JA01#
		3300pF		±5%	GRM1882C1H332JA01#	
		3900pF		±5%	GRM1882C1H392JA01#	
		4700pF		±5%	GRM1882C1H472JA01#	
		5600pF		±5%	GRM1882C1H562JA01#	
		10Vdc	U2J	12000pF	±5%	GRM1887U1A123JA01#
				15000pF	±5%	GRM1887U1A153JA01#
				18000pF	±5%	GRM1887U1A183JA01#
				22000pF	±5%	GRM1887U1A223JA01#
				UJ	12000pF	±5%
			15000pF		±5%	GRM1883U1A153JA01#
18000pF	±5%		GRM1883U1A183JA01#			
22000pF	±5%		GRM1883U1A223JA01#			

2.0×1.25mm

T max.	Rated Voltage	TC Code	Cap.	Tol.	Part Number		
0.65mm	100Vdc	COG	5600pF	±5%	GRM2165C2A562JA01#		
			6800pF	±5%	GRM2165C2A682JA01#		
			8200pF	±5%	GRM2165C2A822JA01#		
			10000pF	±5%	GRM2165C2A103JA01#		
			12000pF	±5%	GRM2165C2A123JA01#		
			15000pF	±5%	GRM2165C2A153JA01#		
			50Vdc	COG	18000pF	±5%	GRM2165C1H183JA01#
					22000pF	±5%	GRM2165C1H223JA01#
					27000pF	±5%	GRM2165C1H273JA01#
					33000pF	±5%	GRM2165C1H333JA01#
0.7mm	100Vdc	COG			1000pF	±5%	GRM2165C2A102JA01#
			1200pF	±5%	GRM2165C2A122JA01#		
			1500pF	±5%	GRM2165C2A152JA01#		
			1800pF	±5%	GRM2165C2A182JA01#		
			2200pF	±5%	GRM2165C2A222JA01#		
			2700pF	±5%	GRM2165C2A272JA01#		
			3300pF	±5%	GRM2165C2A332JA01#		
			3900pF	±5%	GRM2165C2A392JA01#		
			4700pF	±5%	GRM2165C2A472JA01#		

Part number # indicates the package specification code.

GRM
 GR3
 GRJ
 GR4
 GJM
 GQM
 GA2
 GA3 GB
 GA3 GD
 GA3 GF
 LLL
 LLA
 LLM
 LLR
 NFM
 KRM
 KR3
 GMA
 GMD
 ⚠Caution /Notice

GRM Series Temperature Compensating Type Part Number List

(→ 2.0×1.25mm)

T max.	Rated Voltage	TC Code	Cap.	Tol.	Part Number	T max.	Rated Voltage	TC Code	Cap.	Tol.	Part Number	
0.7mm	100Vdc	CH	1000pF	±5%	GRM2162C2A102JA01#	1.0mm	250Vdc	COG	22pF	±5%	GRM21A5C2E220JW01#	
			1200pF	±5%	GRM2162C2A122JA01#				33pF	±5%	GRM21A5C2E330JW01#	
			1500pF	±5%	GRM2162C2A152JA01#				47pF	±5%	GRM21A5C2E470JW01#	
			1800pF	±5%	GRM2162C2A182JA01#				68pF	±5%	GRM21A5C2E680JW01#	
			2200pF	±5%	GRM2162C2A222JA01#				100pF	±5%	GRM21A5C2E101JW01#	
			2700pF	±5%	GRM2162C2A272JA01#				150pF	±5%	GRM21A5C2E151JW01#	
			3300pF	±5%	GRM2162C2A332JA01#				220pF	±5%	GRM21A5C2E221JW01#	
			3900pF	±5%	GRM2162C2A392JA01#				330pF	±5%	GRM21A5C2E331JW01#	
			4700pF	±5%	GRM2162C2A472JA01#				470pF	±5%	GRM21A5C2E471JWA1#	
			50Vdc	COG	2700pF				±5%	GRM2165C1H272JA01#	680pF	±5%
	3300pF	±5%			GRM2165C1H332JA01#				1000pF	±5%	GRM21A5C2E102JWA1#	
	3900pF	±5%			GRM2165C1H392JA01#				1500pF	±5%	GRM21A5C2E152JWA1#	
	4700pF	±5%			GRM2165C1H472JA01#				2200pF	±5%	GRM21A5C2E222JWA1#	
	CH	2700pF			±5%				GRM2162C1H272JA01#	100pF	±5%	GRM21A7U2E101JW31#
		3300pF		±5%	GRM2162C1H332JA01#				150pF	±5%	GRM21A7U2E151JW31#	
		3900pF		±5%	GRM2162C1H392JA01#				220pF	±5%	GRM21A7U2E221JW31#	
		4700pF		±5%	GRM2162C1H472JA01#				330pF	±5%	GRM21A7U2E331JW31#	
		470pF		±5%	GRM21A7U2E471JW31#							
	0.95mm	100Vdc		COG	5600pF				±5%	GRM2195C2A562JA01#	680pF	±5%
			6800pF		±5%				GRM2195C2A682JA01#	1000pF	±5%	GRM21A7U2E102JW31#
8200pF			±5%		GRM2195C2A822JA01#	1500pF	±5%	GRM21A7U2E152JW31#				
10000pF			±5%		GRM2195C2A103JA01#	2200pF	±5%	GRM21A7U2E222JW31#				
15000pF			±5%		GRM2195C2A153JA01#	200Vdc	COG	10pF	±5%	GRM21A5C2D100JW01#		
5600pF			±5%	GRM2192C2A562JA01#	15pF			±5%	GRM21A5C2D150JW01#			
6800pF			±5%	GRM2192C2A682JA01#	22pF			±5%	GRM21A5C2D220JW01#			
8200pF			±5%	GRM2192C2A822JA01#	33pF			±5%	GRM21A5C2D330JW01#			
10000pF			±5%	GRM2192C2A103JA01#	47pF			±5%	GRM21A5C2D470JW01#			
15000pF			±5%	GRM2192C2A153JA01#	68pF		±5%	GRM21A5C2D680JW01#				
50Vdc		COG	5600pF	±5%	GRM2195C1H562JA01#		100pF	±5%	GRM21A5C2D101JW01#			
			6800pF	±5%	GRM2195C1H682JA01#		150pF	±5%	GRM21A5C2D151JW01#			
			8200pF	±5%	GRM2195C1H822JA01#		220pF	±5%	GRM21A5C2D221JW01#			
			10000pF	±5%	GRM2195C1H103JA01#		330pF	±5%	GRM21A5C2D331JW01#			
			12000pF	±5%	GRM2195C1H123JA01#	U2J	100pF	±5%	GRM21A7U2D101JW31#			
		15000pF	±5%	GRM2195C1H153JA01#	150pF		±5%	GRM21A7U2D151JW31#				
		5600pF	±5%	GRM2192C1H562JA01#	220pF		±5%	GRM21A7U2D221JW31#				
		6800pF	±5%	GRM2192C1H682JA01#	330pF		±5%	GRM21A7U2D331JW31#				
		8200pF	±5%	GRM2192C1H822JA01#	470pF		±5%	GRM21A7U2D471JW31#				
		10Vdc	U2J	5600pF	±5%	GRM2197U1A563JA01#	680pF	±5%	GRM21A7U2D681JW31#			
5600pF	±5%			GRM2193U1A563JA01#	1000pF	±5%	GRM21A7U2D102JW31#					
UJ	5600pF		±5%	GRM2193U1A563JA01#	1500pF	±5%	GRM21A7U2D152JW31#					
	5600pF		±5%	GRM2193U1A563JA01#	2200pF	±5%	GRM21A7U2D222JW31#					
	10pF		±5%	GRM21A5C2J100JWA1#	1.35mm	100Vdc	COG	22000pF	±5%	GRM21B5C2A223JA01#		
	15pF		±5%	GRM21A5C2J150JWA1#				CH	22000pF	±5%	GRM21B2C2A223JA01#	
	22pF		±5%	GRM21A5C2J220JWA1#			50Vdc		COG	18000pF	±5%	GRM21B5C1H183JA01#
	33pF		±5%	GRM21A5C2J330JWA1#						CH	22000pF	±5%
	47pF		±5%	GRM21A5C2J470JWA1#				U2J	18000pF		±5%	GRM21B2C1H183JA01#
	68pF		±5%	GRM21A5C2J680JWA1#		22000pF			±5%		GRM21B2C1H223JA01#	
100pF	±5%	GRM21A5C2J101JWA1#	UJ	39000pF		±5%		GRM21B7U1H393JA01#				
150pF	±5%	GRM21A5C2J151JWA1#		47000pF		±5%	GRM21B7U1H473JA01#					
220pF	±5%	GRM21A5C2J221JWA1#		UJ		39000pF	±5%	GRM21B3U1H393JA01#				
330pF	±5%	GRM21A5C2J331JWA1#				47000pF	±5%	GRM21B3U1H473JA01#				
470pF	±5%	GRM21A5C2J471JWA1#		10Vdc	U2J	68000pF	±5%	GRM21B7U1A683JA01#				
250Vdc	COG	10pF	±5%			GRM21A5C2E100JW01#	82000pF	±5%	GRM21B7U1A823JA01#			
		15pF	±5%			GRM21A5C2E150JW01#	0.10μF	±5%	GRM21B7U1A104JA01#			

Part number # indicates the package specification code.

GRM
 GR3
 GRJ
 GR4
 GJM
 GQM
 GA2
 GA3 GB
 GA3 GD
 GA3 GF
 LLL
 LLA
 LLM
 LLR
 NFM
 KRM
 KR3
 GMA
 GMD
 ⚠Caution /Notice

GRM Series Temperature Compensating Type Part Number List

(→ 2.0×1.25mm)

T max.	Rated Voltage	TC Code	Cap.	Tol.	Part Number
1.35mm	10Vdc	UJ	6800pF	±5%	GRM21B3U1A683JA01#
			8200pF	±5%	GRM21B3U1A823JA01#
			0.10μF	±5%	GRM21B3U1A104JA01#
1.45mm	630Vdc	COG	680pF	±5%	GRM21B5C2J681JWA3#
			1000pF	±5%	GRM21B5C2J102JWA3#
			1500pF	±5%	GRM21B5C2J152JWAA#
			2200pF	±5%	GRM21B5C2J222JWAA#
	250Vdc	COG	3300pF	±5%	GRM21B5C2E332JWA1#
			4700pF	±5%	GRM21B5C2E472JWA1#
			6800pF	±5%	GRM21B5C2E682JWAA#
		U2J	10000pF	±5%	GRM21B5C2E103JWAA#
			3300pF	±5%	GRM21B7U2E332JW32#
			4700pF	±5%	GRM21B7U2E472JW32#
200Vdc	U2J	3300pF	±5%	GRM21B7U2D332JW32#	
		4700pF	±5%	GRM21B7U2D472JW32#	

3.2×1.6mm

T max.	Rated Voltage	TC Code	Cap.	Tol.	Part Number	
0.95mm	100Vdc	COG	4700pF	±5%	GRM3195C2A472JA01#	
			5600pF	±5%	GRM3195C2A562JA01#	
			6800pF	±5%	GRM3195C2A682JA01#	
			8200pF	±5%	GRM3195C2A822JA01#	
			10000pF	±5%	GRM3195C2A103JA01#	
			12000pF	±5%	GRM3195C2A123JA01#	
			15000pF	±5%	GRM3195C2A153JA01#	
			18000pF	±5%	GRM3195C2A183JA01#	
			22000pF	±5%	GRM3195C2A223JA01#	
			27000pF	±5%	GRM3195C2A273JA01#	
			33000pF	±5%	GRM3195C2A333JA01#	
			39000pF	±5%	GRM3195C2A393JA01# D1	
			CH	5600pF	±5%	GRM3192C2A562JA01#
				6800pF	±5%	GRM3192C2A682JA01#
				8200pF	±5%	GRM3192C2A822JA01#
				10000pF	±5%	GRM3192C2A103JA01#
				12000pF	±5%	GRM3192C2A123JA01#
				15000pF	±5%	GRM3192C2A153JA01#
		18000pF		±5%	GRM3192C2A183JA01#	
		22000pF		±5%	GRM3192C2A223JA01#	
		27000pF		±5%	GRM3192C2A273JA01#	
		33000pF		±5%	GRM3192C2A333JA01#	
		39000pF		±5%	GRM3192C2A393JA01# D1	
		50Vdc		COG	12000pF	±5%
			15000pF		±5%	GRM3195C1H153JA01#
			18000pF		±5%	GRM3195C1H183JA01#
			22000pF		±5%	GRM3195C1H223JA01#
			27000pF		±5%	GRM3195C1H273JA01#
			33000pF		±5%	GRM3195C1H333JA01#
			39000pF		±5%	GRM3195C1H393JA01#
			47000pF		±5%	GRM3195C1H473JA05#
			56000pF		±5%	GRM3195C1H563JA05#
			68000pF		±5%	GRM3195C1H683JA05#
			82000pF		±5%	GRM3195C1H823JA05#

T max.	Rated Voltage	TC Code	Cap.	Tol.	Part Number				
0.95mm	50Vdc	COG	0.10μF	±5%	GRM3195C1H104JA05#				
			CH	12000pF	±5%	GRM3192C1H123JA01#			
		1.0mm	2000Vdc	U2J	15000pF	±5%	GRM3192C1H153JA01#		
					18000pF	±5%	GRM3192C1H183JA01#		
					22000pF	±5%	GRM3192C1H223JA01#		
					27000pF	±5%	GRM3192C1H273JA01#		
					33000pF	±5%	GRM3192C1H333JA01#		
					39000pF	±5%	GRM3192C1H393JA01#		
					1000Vdc	COG	10pF	±5%	GRM31A7U3D100JW31#
							15pF	±5%	GRM31A7U3D150JW31#
		22pF	±5%	GRM31A7U3D220JW31#					
		33pF	±5%	GRM31A7U3D330JW31#					
47pF	±5%	GRM31A7U3D470JW31#							
68pF	±5%	GRM31A7U3D680JW31#							
630Vdc	COG	10pF	±5%	GRM31A5C3A100JW01#					
		15pF	±5%	GRM31A5C3A150JW01#					
		22pF	±5%	GRM31A5C3A220JW01#					
		33pF	±5%	GRM31A5C3A330JW01#					
		47pF	±5%	GRM31A5C3A470JW01#					
		68pF	±5%	GRM31A5C3A680JW01#					
		U2J	100pF	±5%	GRM31A5C3A101JW01#				
			150pF	±5%	GRM31A5C3A151JW01#				
			220pF	±5%	GRM31A5C3A221JW01#				
			330pF	±5%	GRM31A5C3A331JWA1#				
470pF	±5%		GRM31A5C3A471JWA1#						
10pF	±5%		GRM31A7U3A100JW31#						
15pF	±5%		GRM31A7U3A150JW31#						
22pF	±5%		GRM31A7U3A220JW31#						
33pF	±5%		GRM31A7U3A330JW31#						
47pF	±5%		GRM31A7U3A470JW31#						
68pF	±5%	GRM31A7U3A680JW31#							
100pF	±5%	GRM31A7U3A101JW31#							
150pF	±5%	GRM31A7U3A151JW31#							
220pF	±5%	GRM31A7U3A221JW31#							
330pF	±5%	GRM31A7U3A331JW31#							
U2J	COG	10pF	±5%	GRM31A5C2J100JW01#					
		15pF	±5%	GRM31A5C2J150JW01#					
		22pF	±5%	GRM31A5C2J220JW01#					
		33pF	±5%	GRM31A5C2J330JW01#					
		47pF	±5%	GRM31A5C2J470JW01#					
		68pF	±5%	GRM31A5C2J680JW01#					
		100pF	±5%	GRM31A5C2J101JW01#					
		150pF	±5%	GRM31A5C2J151JW01#					
		220pF	±5%	GRM31A5C2J221JW01#					
		330pF	±5%	GRM31A5C2J331JW01#					
U2J	U2J	470pF	±5%	GRM31A5C2J471JW01#					
		1500pF	±5%	GRM31A5C2J152JWA1#					
		10pF	±5%	GRM31A7U2J100JW31#					
		15pF	±5%	GRM31A7U2J150JW31#					
		22pF	±5%	GRM31A7U2J220JW31#					
		33pF	±5%	GRM31A7U2J330JW31#					
		47pF	±5%	GRM31A7U2J470JW31#					
		68pF	±5%	GRM31A7U2J680JW31#					
		100pF	±5%	GRM31A7U2J101JW31#					

Part number # indicates the package specification code.

GRM
 GR3
 GRJ
 GR4
 GJM
 GQM
 GA2
 GA3 GB
 GA3 GD
 GA3 GF
 LLL
 LLA
 LLM
 LLR
 NFM
 KRM
 KR3
 GMA
 GMD
 ⚠Caution /Notice

GRM Series Temperature Compensating Type Part Number List

(→ 3.2×1.6mm)

T max.	Rated Voltage	TC Code	Cap.	Tol.	Part Number
1.0mm	630Vdc	U2J	150pF	±5%	GRM31A7U2J151JW31#
			220pF	±5%	GRM31A7U2J221JW31#
			330pF	±5%	GRM31A7U2J331JW31#
			470pF	±5%	GRM31A7U2J471JW31#
			680pF	±5%	GRM31A7U2J681JW31#
			1000pF	±5%	GRM31A7U2J102JW31#
			1500pF	±5%	GRM31A7U2J152JW31#
			2200pF	±5%	GRM31A7U2J222JW31#
	500Vdc	COG	10pF	±5%	GRM31A5C2H100JW01#
			15pF	±5%	GRM31A5C2H150JW01#
			22pF	±5%	GRM31A5C2H220JW01#
			33pF	±5%	GRM31A5C2H330JW01#
			47pF	±5%	GRM31A5C2H470JW01#
			68pF	±5%	GRM31A5C2H680JW01#
			100pF	±5%	GRM31A5C2H101JW01#
			150pF	±5%	GRM31A5C2H151JW01#
			220pF	±5%	GRM31A5C2H221JW01#
			330pF	±5%	GRM31A5C2H331JW01#
		470pF	±5%	GRM31A5C2H471JW01#	
		U2J	10pF	±5%	GRM31A7U2H100JW31#
			15pF	±5%	GRM31A7U2H150JW31#
			22pF	±5%	GRM31A7U2H220JW31#
			33pF	±5%	GRM31A7U2H330JW31#
			47pF	±5%	GRM31A7U2H470JW31#
			68pF	±5%	GRM31A7U2H680JW31#
			100pF	±5%	GRM31A7U2H101JW31#
			150pF	±5%	GRM31A7U2H151JW31#
			220pF	±5%	GRM31A7U2H221JW31#
330pF	±5%		GRM31A7U2H331JW31#		
470pF	±5%	GRM31A7U2H471JW31#			
680pF	±5%	GRM31A7U2H681JW31#			
1000pF	±5%	GRM31A7U2H102JW31#			
1500pF	±5%	GRM31A7U2H152JW31#			
2200pF	±5%	GRM31A7U2H222JW31#			
1.25mm	1000Vdc	COG	680pF	±5%	GRM31B5C3A681JWA1#
			470pF	±5%	GRM31B7U3A471JW31#
		U2J	680pF	±5%	GRM31B7U3A681JW31#
	630Vdc	COG	680pF	±5%	GRM31B5C2J681JW01#
			1000pF	±5%	GRM31B5C2J102JW01#
			2200pF	±5%	GRM31B5C2J222JWA1#
	500Vdc	COG	680pF	±5%	GRM31B5C2H681JW01#
			1000pF	±5%	GRM31B5C2H102JW01#
			U2J	3300pF	±5%
	250Vdc	U2J	6800pF	±5%	GRM31B7U2E682JW31#
			10000pF	±5%	GRM31B7U2E103JW31#
	200Vdc	U2J	6800pF	±5%	GRM31B7U2D682JW31#
			10000pF	±5%	GRM31B7U2D103JW31#
	100Vdc	COG	4700pF	±5%	GRM31M5C2A473JA01#
			5600pF	±5%	GRM31M5C2A563JA01# D1
		CH	4700pF	±5%	GRM31M2C2A473JA01#
			5600pF	±5%	GRM31M2C2A563JA01# D1
	50Vdc	COG	47000pF	±5%	GRM31M5C1H473JA01#
			56000pF	±5%	GRM31M5C1H563JA01#

T max.	Rated Voltage	TC Code	Cap.	Tol.	Part Number			
1.25mm	50Vdc	CH	47000pF	±5%	GRM31M2C1H473JA01#			
			56000pF	±5%	GRM31M2C1H563JA01#			
			U2J	68000pF	±5%	GRM31M7U1H683JA01#		
				82000pF	±5%	GRM31M7U1H823JA01#		
			UJ	0.10μF	±5%	GRM31M7U1H104JA01#		
		68000pF		±5%	GRM31M3U1H683JA01#			
		1.8mm	1000Vdc	COG	1000pF	±5%	GRM31C5C3A102JWA3#	
					U2J	1000pF	±5%	GRM31C7U3A102JW32#
				630Vdc	COG	3300pF	±5%	GRM31C5C2J332JWA3#
						4700pF	±5%	GRM31C5C2J472JWA3#
6800pF	±5%					GRM31C5C2J682JWA3#		
500Vdc	U2J	4700pF	±5%	GRM31C7U2H472JW32#				
		250Vdc	COG	15000pF	±5%	GRM31C5C2E153JWA3#		
100Vdc	COG	22000pF		±5%	GRM31C5C2E223JWA3#			
		68000pF	±5%	GRM31C5C2A683JA01# D1				
		82000pF	±5%	GRM31C5C2A823JA01# D1				
		0.10μF	±5%	GRM31C5C2A104JA01# D1				
		CH	68000pF	±5%	GRM31C2C2A683JA01# D1			
	50Vdc	COG	82000pF	±5%	GRM31C2C2A823JA01# D1			
			0.10μF	±5%	GRM31C2C2A104JA01# D1			
			68000pF	±5%	GRM31C5C1H683JA01#			
			82000pF	±5%	GRM31C5C1H823JA01#			
			0.10μF	±5%	GRM31C5C1H104JA01#			
1.0mm	2000Vdc	U2J	100pF	±5%	GRM32A7U3D101JW31#			
			150pF	±5%	GRM32A7U3D151JW31#			
			630Vdc	1500pF	±5%	GRM32A7U2J152JW31#		
				2200pF	±5%	GRM32A7U2J222JW31#		
			500Vdc	U2J	1500pF	±5%	GRM32A7U2H152JW31#	
		2200pF			±5%	GRM32A7U2H222JW31#		
		1.25mm	2000Vdc	U2J	220pF	±5%	GRM32B7U3D221JW31#	
					1.5mm	1000Vdc	U2J	1500pF
		630Vdc	U2J	6800pF				±5%
		500Vdc	U2J	6800pF		±5%	GRM32Q7U2H682JW31#	
2.0mm	1000Vdc	U2J	2200pF	±5%	GRM32D7U3A222JW31#			
			630Vdc	U2J	10000pF	±5%	GRM32D7U2J103JW31#	
	500Vdc	U2J	10000pF	±5%	GRM32D7U2H103JW31#			
			630Vdc	U2J	15000pF	±5%	GRM32E7U2J153JW32#	

3.2×2.5mm

T max.	Rated Voltage	TC Code	Cap.	Tol.	Part Number	
1.0mm	2000Vdc	U2J	100pF	±5%	GRM32A7U3D101JW31#	
			150pF	±5%	GRM32A7U3D151JW31#	
			630Vdc	1500pF	±5%	GRM32A7U2J152JW31#
				2200pF	±5%	GRM32A7U2J222JW31#
			500Vdc	U2J	1500pF	±5%
	2200pF	±5%			GRM32A7U2H222JW31#	
	1.25mm	2000Vdc	U2J	220pF	±5%	GRM32B7U3D221JW31#
				1.5mm	1000Vdc	U2J
	630Vdc	U2J	6800pF			
	500Vdc	U2J	6800pF		±5%	GRM32Q7U2H682JW31#
2.0mm	1000Vdc	U2J	2200pF	±5%	GRM32D7U3A222JW31#	
			630Vdc	U2J	10000pF	±5%
	500Vdc	U2J	10000pF	±5%	GRM32D7U2H103JW31#	
			630Vdc	U2J	15000pF	±5%

Part number # indicates the package specification code.

GRM
 GR3
 GRJ
 GR4
 GJM
 GQM
 GA2
 GA3 GB
 GA3 GD
 GA3 GF
 LLL
 LLA
 LLM
 LLR
 NFM
 KRM
 KR3
 GMA
 GMD
 ⚠Caution / Notice

GRM Series Temperature Compensating Type Part Number List

4.5×2.0mm

T max.	Rated Voltage	TC Code	Cap.	Tol.	Part Number
1.0mm	3150Vdc	U2J	10pF	±5%	GRM42A7U3F100JW31#
			15pF	±5%	GRM42A7U3F150JW31#
			22pF	±5%	GRM42A7U3F220JW31#
			33pF	±5%	GRM42A7U3F330JW31#
			47pF	±5%	GRM42A7U3F470JW31#
			68pF	±5%	GRM42A7U3F680JW31#
			100pF	±5%	GRM42A7U3F101JW31#

4.5×3.2mm

T max.	Rated Voltage	TC Code	Cap.	Tol.	Part Number
1.5mm	1000Vdc	U2J	3300pF	±5%	GRM43Q7U3A332JW31#
2.0mm	1000Vdc	U2J	4700pF	±5%	GRM43D7U3A472JW31#
			630Vdc	U2J	15000pF
	500Vdc	U2J	22000pF	±5%	GRM43D7U2J223JW31#
			15000pF	±5%	GRM43D7U2H153JW31#
			22000pF	±5%	GRM43D7U2H223JW31#

5.7×5.0mm

T max.	Rated Voltage	TC Code	Cap.	Tol.	Part Number
1.5mm	1000Vdc	U2J	6800pF	±5%	GRM55Q7U3A682JW31#
2.0mm	1000Vdc	U2J	10000pF	±5%	GRM55D7U3A103JW31#
			630Vdc	U2J	33000pF
	500Vdc	U2J	47000pF	±5%	GRM55D7U2J473JW31#
			33000pF	±5%	GRM55D7U2H333JW31#
			47000pF	±5%	GRM55D7U2H473JW31#

GRM
 GR3
 GRJ
 GR4
 GJM
 GQM
 GA2
 GA3 GB
 GA3 GD
 GA3 GF
 LLL
 LLA
 LLM
 LLR
 NFM
 KRM
 KR3
 GMA
 GMD
 △Caution /Notice

GRM Series High Dielectric Constant Type Part Number List

0.25×0.125mm

T max.	Rated Voltage	TC Code	Cap.	Tol.	Part Number	
0.138mm	10Vdc	X5R	100pF	±10%	GRM011R61A101KE01#	
				±20%	GRM011R61A101ME01#	
			220pF	±10%	GRM011R61A221KE01#	
				±20%	GRM011R61A221ME01#	
			470pF	±10%	GRM011R61A471KE01#	
				±20%	GRM011R61A471ME01#	
		6.3Vdc	X5R	1000pF	±10%	GRM011R60J102KE01#
					±20%	GRM011R60J102ME01#
				1500pF	±10%	GRM011R60J152KE01#
					±20%	GRM011R60J152ME01#
				2200pF	±10%	GRM011R60J222KE01#
					±20%	GRM011R60J222ME01#
	10000pF	X5R	3300pF	±10%	GRM011R60J332KE01# D1	
				±20%	GRM011R60J332ME01#	
			4700pF	±10%	GRM011R60J472KE01# D1	
				±20%	GRM011R60J472ME01#	
	6800pF	X5R	6800pF	±10%	GRM011R60J682KE01# D1	
				±20%	GRM011R60J682ME01#	
10000pF	X5R	10000pF	±10%	GRM011R60J103KE01# D1		
			±20%	GRM011R60J103ME01#		

0.4×0.2mm

T max.	Rated Voltage	TC Code	Cap.	Tol.	Part Number	
0.22mm	16Vdc	X7R	100pF	±10%	GRM022R71C101KE14#	
				±20%	GRM022R71C101ME14#	
			150pF	±10%	GRM022R71C151KE14#	
				±20%	GRM022R71C151ME14#	
			220pF	±10%	GRM022R71C221KE14#	
				±20%	GRM022R71C221ME14#	
			330pF	±10%	GRM022R71C331KE14#	
				±20%	GRM022R71C331ME14#	
			470pF	±10%	GRM022R71C471KE14#	
				±20%	GRM022R71C471ME14#	
			1000pF	±10%	GRM022R71C102KE14#	
				±20%	GRM022R71C102ME14#	
			X5R	1000pF	±10%	GRM022R61C102KE01# D1
					±20%	GRM022R61C102ME01# D1
				2200pF	±10%	GRM022R61C222KE01# D1
					±20%	GRM022R61C222ME01# D1
				4700pF	±10%	GRM022R61C472KE01# D1
					±20%	GRM022R61C472ME01# D1
		10000pF	±10%	GRM022R61C103KE01# D1		
			±20%	GRM022R61C103ME01# D1		
		10Vdc	X7R	100pF	±10%	GRM022R71A101KA01#
					±20%	GRM022R71A101MA01#
				150pF	±10%	GRM022R71A151KA01#
					±20%	GRM022R71A151MA01#
				220pF	±10%	GRM022R71A221KA01#
					±20%	GRM022R71A221MA01#
				330pF	±10%	GRM022R71A331KA01#
					±20%	GRM022R71A331MA01#
				470pF	±10%	GRM022R71A471KA01#
					±20%	GRM022R71A471MA01#
				680pF	±10%	GRM022R71A681KA12#
					±20%	GRM022R71A681MA12#
				820pF	±10%	GRM022R71A821KA12#
					±20%	GRM022R71A821MA12#

T max.	Rated Voltage	TC Code	Cap.	Tol.	Part Number	
0.22mm	10Vdc	X7R	1000pF	±10%	GRM022R71A102KA12#	
				±20%	GRM022R71A102MA12#	
			X5R	100pF	±10%	GRM022R61A101KA01#
					±20%	GRM022R61A101MA01#
			150pF	±10%	GRM022R61A151KA01#	
				±20%	GRM022R61A151MA01#	
			220pF	±10%	GRM022R61A221KA01#	
				±20%	GRM022R61A221MA01#	
			330pF	±10%	GRM022R61A331KA01#	
				±20%	GRM022R61A331MA01#	
			470pF	±10%	GRM022R61A471KA01#	
				±20%	GRM022R61A471MA01#	
			680pF	±10%	GRM022R61A681KE19#	
				±20%	GRM022R61A681ME19#	
			1000pF	±10%	GRM022R61A102KE19#	
				±20%	GRM022R61A102ME19#	
			1500pF	±10%	GRM022R61A152KE19#	
				±20%	GRM022R61A152ME19#	
		2200pF	±10%	GRM022R61A222KE19#		
			±20%	GRM022R61A222ME19#		
		3300pF	±10%	GRM022R61A332KE19#		
			±20%	GRM022R61A332ME19#		
		4700pF	±10%	GRM022R61A472KE19#		
			±20%	GRM022R61A472ME19#		
		6800pF	±10%	GRM022R61A682KE19#		
			±20%	GRM022R61A682ME19#		
		10000pF	±10%	GRM022R61A103KE19#		
			±20%	GRM022R61A103ME19#		
		B	10Vdc	100pF	±10%	GRM022B11A101KA01#
					±20%	GRM022B11A101MA01#
				150pF	±10%	GRM022B11A151KA01#
					±20%	GRM022B11A151MA01#
				220pF	±10%	GRM022B11A221KA01#
					±20%	GRM022B11A221MA01#
				330pF	±10%	GRM022B11A331KA01#
					±20%	GRM022B11A331MA01#
				470pF	±10%	GRM022B11A471KA01#
					±20%	GRM022B11A471MA01#
				680pF	±10%	GRM022B31A681KE19#
					±20%	GRM022B31A681ME19#
				1000pF	±10%	GRM022B31A102KE19#
					±20%	GRM022B31A102ME19#
				1500pF	±10%	GRM022B31A152KE19#
					±20%	GRM022B31A152ME19#
				2200pF	±10%	GRM022B31A222KE19#
					±20%	GRM022B31A222ME19#
		3300pF	±10%	GRM022B31A332KE19#		
			±20%	GRM022B31A332ME19#		
		4700pF	±10%	GRM022B31A472KE19#		
			±20%	GRM022B31A472ME19#		
		6800pF	±10%	GRM022B31A682KE19#		
			±20%	GRM022B31A682ME19#		
		10000pF	±10%	GRM022B31A103KE19#		
			±20%	GRM022B31A103ME19#		

Part number # indicates the package specification code.

GRM
 GR3
 GRJ
 GR4
 GJM
 GQM
 GA2
 GA3 GB
 GA3 GD
 GA3 GF
 LLL
 LLA
 LLM
 LLR
 NFM
 KRM
 KR3
 GMA
 GMD
 ⚠Caution / Notice

GRM Series High Dielectric Constant Type Part Number List

(→ 0.4×0.2mm)

T max.	Rated Voltage	TC Code	Cap.	Tol.	Part Number		
0.22mm	6.3Vdc	X5R	1000pF	±20%	GRM022R60J102ME19#		
			1500pF	±20%	GRM022R60J152ME19#		
			2200pF	±20%	GRM022R60J222ME19#		
			3300pF	±20%	GRM022R60J332ME19#		
			4700pF	±20%	GRM022R60J472ME19#		
			6800pF	±20%	GRM022R60J682ME19#		
			10000pF	±20%	GRM022R60J103ME19#		
			15000pF	±20%	GRM022R60J153ME15#	D1	
			22000pF	±10%	GRM022R60J223KE15#	D1	
				±20%	GRM022R60J223ME15#	D1	
			33000pF	±20%	GRM022R60J333ME15#	D1	
			47000pF	±20%	GRM022R60J473ME15#	D1	
		68000pF	±20%	GRM022R60J683ME15#	D1		
		0.10μF	±20%	GRM022R60J104ME15#	D1		
		B	1000pF	±20%	GRM022B30J102ME19#		
			1500pF	±20%	GRM022B30J152ME19#		
			2200pF	±20%	GRM022B30J222ME19#		
			3300pF	±20%	GRM022B30J332ME19#		
	4700pF		±20%	GRM022B30J472ME19#			
	6800pF		±20%	GRM022B30J682ME19#			
	10000pF		±20%	GRM022B30J103ME19#			
	4Vdc		X6T	0.10μF	±20%	GRM022D80G104ME15#	D1
				X5R	15000pF	±10%	GRM022R60G153KE15#
			±20%		GRM022R60G153ME15#		
		22000pF	±10%		GRM022R60G223KE15#		
		±20%	GRM022R60G223ME15#				
		33000pF	±10%	GRM022R60G333KE15#			
	±20%	GRM022R60G333ME15#					
	47000pF	±10%	GRM022R60G473KE15#				
	±20%	GRM022R60G473ME15#					
	68000pF	±20%	GRM022R60G683ME15#				
	0.10μF	±20%	GRM022R60G104ME15#				
	2.5Vdc	X6T	0.10μF	±20%	GRM022D80E104ME15#		
0.25mm	4Vdc	X6T	0.47μF	±20%	GRM022D80G474ME01#	D1	
			2.5Vdc	X7T	0.47μF	±20%	GRM022D70E474ME01#
	X6T	0.47μF			±20%	GRM022D80E474ME01#	

0.6×0.3mm

T max.	Rated Voltage	TC Code	Cap.	Tol.	Part Number
0.33mm	50Vdc	X7R	100pF	±10%	GRM033R71H101KA12#
				±20%	GRM033R71H101MA12#
			150pF	±10%	GRM033R71H151KA12#
				±20%	GRM033R71H151MA12#
			220pF	±10%	GRM033R71H221KA12#
				±20%	GRM033R71H221MA12#
			330pF	±10%	GRM033R71H331KA12#
				±20%	GRM033R71H331MA12#
			470pF	±10%	GRM033R71H471KA12#
				±20%	GRM033R71H471MA12#
			680pF	±10%	GRM033R71H681KA12#
				±20%	GRM033R71H681MA12#
			1000pF	±10%	GRM033R71H102KA12#

T max.	Rated Voltage	TC Code	Cap.	Tol.	Part Number		
0.33mm	50Vdc	X7R	1000pF	±20%	GRM033R71H102MA12#		
				±10%	GRM033R71H152KA12#		
			1500pF	±20%	GRM033R71H152MA12#		
				±10%	GRM033R61H471KA12#		
			X5R	470pF	±10%	GRM033R61H471KA12#	
				B	100pF	±10%	GRM033B31H101KA12#
		±20%	GRM033B31H101MA12#				
		150pF	±10%		GRM033B31H151KA12#		
			±20%		GRM033B31H151MA12#		
		220pF	±10%		GRM033B31H221KA12#		
			±20%		GRM033B31H221MA12#		
		330pF	±10%	GRM033B31H331KA12#			
			±20%	GRM033B31H331MA12#			
		470pF	±10%	GRM033B31H471KA12#			
			±20%	GRM033B31H471MA12#			
		680pF	±10%	GRM033B31H681KA12#			
			±20%	GRM033B31H681MA12#			
		1000pF	±10%	GRM033B31H102KA12#			
			±20%	GRM033B31H102MA12#			
		1500pF	±10%	GRM033B31H152KA12#			
			±20%	GRM033B31H152MA12#			
		35Vdc	X5R	0.10μF	±10%	GRM033R6YA104KE14#	D1
					±20%	GRM033R6YA104ME14#	D1
			25Vdc	X7R	1000pF	±10%	GRM033R71E102KA01#
	1500pF				±10%	GRM033R71E152KA01#	
	2200pF				±10%	GRM033R71E222KA12#	
	±20%				GRM033R71E222MA12#		
	3300pF	±10%	GRM033R71E332KA12#				
		±20%	GRM033R71E332MA12#				
	4700pF	±10%	GRM033R71E472KE14#	D1			
		±20%	GRM033R71E472ME14#	D1			
	6800pF	±10%	GRM033R71E682KE14#	D1			
		±20%	GRM033R71E682ME14#	D1			
	10000pF	±10%	GRM033R71E103KE14#	D1			
		±20%	GRM033R71E103ME14#	D1			
	R	100pF	±10%	GRM033R11E101KA01#			
			±10%	GRM033R11E151KA01#			
			±10%	GRM033R11E221KA01#			
			±10%	GRM033R11E331KA01#			
			±10%	GRM033R11E471KA01#			
			±10%	GRM033R11E681KA01#			
		1000pF	±10%	GRM033R11E102KA01#			
			±10%	GRM033R11E152KA01#			
			X6S	0.10μF	±10%	GRM033C81E104KE14#	D1
					±20%	GRM033C81E104ME14#	D1
			X5R	4700pF	±10%	GRM033R61E472KA12#	D1
					±20%	GRM033R61E472MA12#	D1
		6800pF	±10%	GRM033R61E682KA12#	D1		
±20%			GRM033R61E682MA12#	D1			
10000pF		±10%	GRM033R61E103KA12#	D1			
		±20%	GRM033R61E103MA12#	D1			
0.10μF		±10%	GRM033R61E104KE14#	D1			
		±20%	GRM033R61E104ME14#	D1			
0.22μF	±10%	GRM033R61E224KE01#	D1				
	±20%	GRM033R61E224ME01#	D1				

Part number # indicates the package specification code.

GRM
 GR3
 GRJ
 GR4
 GJM
 GQM
 GA2
 GA3 GB
 GA3 GD
 GA3 GF
 LLL
 LLA
 LLM
 LLR
 NFM
 KRM
 KR3
 GMA
 GMD
 ⚠Caution /Notice

GRM Series High Dielectric Constant Type Part Number List

(→ 0.6×0.3mm)

T max.	Rated Voltage	TC Code	Cap.	Tol.	Part Number			
0.33mm	25Vdc	B	1000pF	±10%	GRM033B11E102KA01#			
				±20%	GRM033B11E102MA01#			
			1500pF	±10%	GRM033B11E152KA01#			
				±20%	GRM033B11E152MA01#			
			2200pF	±10%	GRM033B31E222KA12#			
				±20%	GRM033B31E222MA12#			
			3300pF	±10%	GRM033B31E332KA12#			
				±20%	GRM033B31E332MA12#			
			10000pF	±10%	GRM033B31E103KA12#	D1		
				±20%	GRM033B31E103MA12#	D1		
			16Vdc	X7R	2200pF	±10%	GRM033R71C222KA88#	
						±20%	GRM033R71C222MA88#	
					3300pF	±10%	GRM033R71C332KA88#	
						±20%	GRM033R71C332MA88#	
					4700pF	±10%	GRM033R71C472KE14#	
						±20%	GRM033R71C472ME14#	
	6800pF	±10%		GRM033R71C682KE14#				
		±20%		GRM033R71C682ME14#				
	10000pF	±10%		GRM033R71C103KE14#				
		±20%		GRM033R71C103ME14#				
	X7S	0.10μF		±10%	GRM033C71C104KE14#	D1		
				±20%	GRM033C71C104ME14#	D1		
	R	2200pF		±10%	GRM033R11C222KA88#			
				±20%	GRM033R11C222MA88#			
	X6S	0.10μF		±10%	GRM033C81C104KE14#			
				±20%	GRM033C81C104ME14#			
	X5R	10000pF	±10%	GRM033R61C103KA12#				
			±20%	GRM033R61C103MA12#				
		15000pF	±10%	GRM033R61C153KE84#	D1			
			±20%	GRM033R61C153ME84#	D1			
		22000pF	±10%	GRM033R61C223KE84#	D1			
			±20%	GRM033R61C223ME84#	D1			
		33000pF	±10%	GRM033R61C333KE84#	D1			
			±20%	GRM033R61C333ME84#	D1			
		47000pF	±10%	GRM033R61C473KE84#	D1			
			±20%	GRM033R61C473ME84#	D1			
		68000pF	±10%	GRM033R61C683KE84#	D1			
			±20%	GRM033R61C683ME84#	D1			
	0.10μF	±10%	GRM033R61C104KE14#					
		±20%	GRM033R61C104ME14#					
	0.22μF	±10%	GRM033R61C224KE14#					
		±20%	GRM033R61C224ME14#					
	B	2200pF	±10%	GRM033B31C222KA87#				
			±20%	GRM033B31C222MA87#				
		3300pF	±10%	GRM033B31C332KA87#				
			±20%	GRM033B31C332MA87#				
		10000pF	±10%	GRM033B31C103KA12#				
			±20%	GRM033B31C103MA12#				
15000pF		±10%	GRM033B31C153KE84#	D1				
		±20%	GRM033B31C153ME84#	D1				
22000pF		±10%	GRM033B31C223KE84#	D1				
		±20%	GRM033B31C223ME84#	D1				
33000pF		±10%	GRM033B31C333KE84#	D1				
		±20%	GRM033B31C333ME84#	D1				
47000pF	±10%	GRM033B31C473KE84#	D1					
	±20%	GRM033B31C473ME84#	D1					
68000pF	±10%	GRM033B31C683KE84#	D1					
	±20%	GRM033B31C683ME84#	D1					

T max.	Rated Voltage	TC Code	Cap.	Tol.	Part Number			
0.33mm	16Vdc	B	6800pF	±20%	GRM033B31C683ME84#	D1		
				±10%	GRM033B31C104KE84#	D1		
			0.10μF	±20%	GRM033B31C104ME84#	D1		
				±10%	GRM033B31C104ME84#			
			10Vdc	X7R	4700pF	±10%	GRM033R71A472KA01#	
						±20%	GRM033R71A472MA01#	
	6800pF	±10%			GRM033R71A682KA01#			
		±20%			GRM033R71A682MA01#			
	10000pF	±10%			GRM033R71A103KA01#			
		±20%			GRM033R71A103MA01#			
	X7S	0.10μF		±10%	GRM033C71A104KE14#			
				±20%	GRM033C71A104ME14#			
	R	4700pF		±10%	GRM033R11A472KA01#			
				±20%	GRM033R11A472MA01#			
		6800pF		±10%	GRM033R11A682KA01#			
				±20%	GRM033R11A682MA01#			
		10000pF	±10%	GRM033R11A103KA01#				
			±20%	GRM033R11A103MA01#				
	X5R	4700pF	±10%	GRM033R61A472KA01#				
			±20%	GRM033R61A472MA01#				
		6800pF	±10%	GRM033R61A682KA01#				
			±20%	GRM033R61A682MA01#				
		15000pF	±10%	GRM033R61A153KE84#				
			±20%	GRM033R61A153ME84#				
		22000pF	±10%	GRM033R61A223KE84#				
			±20%	GRM033R61A223ME84#				
		33000pF	±10%	GRM033R61A333KE84#				
			±20%	GRM033R61A333ME84#				
		47000pF	±10%	GRM033R61A473KE84#				
			±20%	GRM033R61A473ME84#				
	68000pF	±10%	GRM033R61A683KE84#					
		±20%	GRM033R61A683ME84#					
	0.10μF	±10%	GRM033R61A104KE84#					
		±20%	GRM033R61A104ME84#					
	0.22μF	±20%	GRM033R61A224ME90#	D1				
		±10%	GRM033R61A224ME90#					
	6.3Vdc	X7R	4700pF	±10%	GRM033B11A472KA01#			
				±20%	GRM033B11A472MA01#			
			6800pF	±10%	GRM033B11A682KA01#			
				±20%	GRM033B11A682MA01#			
			15000pF	±10%	GRM033B31A153KE84#			
				±20%	GRM033B31A153ME84#			
		22000pF	±10%	GRM033B31A223KE84#				
			±20%	GRM033B31A223ME84#				
		33000pF	±10%	GRM033B31A333KE84#				
			±20%	GRM033B31A333ME84#				
		47000pF	±10%	GRM033B31A473KE84#				
			±20%	GRM033B31A473ME84#				
68000pF	±10%	GRM033B31A683KE84#						
	±20%	GRM033B31A683ME84#						
0.10μF	±10%	GRM033B31A104KE84#						
	±20%	GRM033B31A104ME84#						
R	4700pF	±10%	GRM033R70J472KA01#					
		±20%	GRM033R70J682KA01#					
		±10%	GRM033R70J103KA01#					
	4700pF	±10%	GRM033R10J472KA01#					

Part number # indicates the package specification code.

GRM
 GR3
 GRJ
 GR4
 GJM
 GQM
 GA2
 GA3 GB
 GA3 GD
 GA3 GF
 LLL
 LLA
 LLM
 LLR
 NFM
 KRM
 KR3
 GMA
 GMD
 ⚠Caution /Notice

GRM Series High Dielectric Constant Type Part Number List

(→ 0.6×0.3mm)

T max.	Rated Voltage	TC Code	Cap.	Tol.	Part Number		
0.33mm	6.3Vdc	R	6800pF	±10%	GRM033R10J682KA01#		
			10000pF	±10%	GRM033R10J103KA01#		
		X6S	15000pF	±10%	GRM033C80J153KE01#		
				±20%	GRM033C80J153ME01#		
			22000pF	±10%	GRM033C80J223KE01#		
				±20%	GRM033C80J223ME01#		
			33000pF	±10%	GRM033C80J333KE01#		
				±20%	GRM033C80J333ME01#		
		47000pF	±10%	GRM033C80J473KE19#			
			±20%	GRM033C80J473ME19#			
		68000pF	±10%	GRM033C80J683KE84#	D1		
			±20%	GRM033C80J683ME84#	D1		
		0.10μF	±10%	GRM033C80J104KE84#	D1		
			±20%	GRM033C80J104ME84#	D1		
		0.22μF	±20%	GRM033C80J224ME90#	D1		
		4Vdc	X6S	0.22μF	±20%	GRM033C80G224ME90#	
	X5R		1.0μF	±20%	GRM033R61A105ME15#		
	X7T		1.0μF	±20%	GRM033D70J105ME01#	D1	
	X7T		1.0μF	±20%	GRM033D70G105ME01#		
	2.5Vdc		X7T	1.0μF	±20%	GRM033D70E105ME15#	

1.0×0.5mm

T max.	Rated Voltage	TC Code	Cap.	Tol.	Part Number	
0.22mm	6.3Vdc	X5R	1.0μF	±20%	GRM152R60J105ME15#	D1
	4Vdc	X6T	1.0μF	±20%	GRM152D80G105ME15#	D1
0.33mm	10Vdc	X5R	1.0μF	±20%	GRM153R61A105ME95#	D1
	6.3Vdc	X6T	1.0μF	±20%	GRM153D80J105ME95#	D1
	4Vdc	X6T	1.0μF	±20%	GRM153D80G105ME95#	
0.55mm	100Vdc	X7R	220pF	±10%	GRM155R72A221KA01#	
			470pF	±10%	GRM155R72A471KA01#	
			1000pF	±10%	GRM155R72A102KA01#	
			2200pF	±10%	GRM155R72A222KA01#	
			4700pF	±10%	GRM155R72A472KA01#	
			2200pF	±10%	GRM155R71H222KA01#	
	50Vdc	X7R	4700pF	±10%	GRM155R71H472KA01#	
			10000pF	±10%	GRM155R71H103KA88#	
			22000pF	±10%	GRM155R71H223KA12#	
			47000pF	±10%	GRM155R71H473KE14#	
			±20%	GRM155R71H473ME14#		

T max.	Rated Voltage	TC Code	Cap.	Tol.	Part Number		
0.55mm	50Vdc	X7R	0.10μF	±10%	GRM155R71H104KE14#		
				±20%	GRM155R71H104ME14#		
			R	2200pF	±10%	GRM155R11H222KA01#	
					±10%	GRM155R11H472KA01#	
			X5R	0.10μF	±10%	GRM155R61H104KE14#	
					±20%	GRM155R61H104ME14#	
		B	0.10μF	±10%	GRM155B31H104KE14#		
				±20%	GRM155B31H104ME14#		
		35Vdc	X6S	0.22μF	±10%	GRM155C8YA224KE01#	D1
					±20%	GRM155C8YA224ME01#	D1
		25Vdc	X7R	22000pF	±10%	GRM155R71E223KA61#	
					±10%	GRM155R71E473KA88#	
	0.10μF			±10%	GRM155R71E104KE14#		
			±20%	GRM155R71E104ME14#			
	X5R		1.0μF	±10%	GRM155R61E105KA12#	D1	
				±20%	GRM155R61E105MA12#	D1	
	B	1.0μF	±10%	GRM155B31E105KA12#	D1		
			±20%	GRM155B31E105MA12#	D1		
	16Vdc	X7R	0.22μF	±10%	GRM155R71C224KA12#		
		X5R	1.0μF	±10%	GRM155R61C105KA12#		
				±20%	GRM155R61C105MA12#		
		B	1.0μF	±10%	GRM155B31C105KA12#		
				±20%	GRM155B31C105MA12#		
10Vdc	X7R	0.22μF	±10%	GRM155R71A224KE01#			
			±20%	GRM155R71A224ME01#			
		0.47μF	±10%	GRM155R71A474KE01#			
			±20%	GRM155R71A474ME01#			
		X6S	1.0μF	±10%	GRM155C81A105KA12#		
				±20%	GRM155C81A105MA12#		
	B	2.2μF	±10%	GRM155B31A225KE95#	D1		
			±20%	GRM155B31A225ME95#	D1		
	6.3Vdc	X7R	1.0μF	±10%	GRM155R70J105KA12#	D1	
				±20%	GRM155R70J105MA12#	D1	
		X6S	2.2μF	±10%	GRM155C80J225KE95#	D1	
				±20%	GRM155C80J225ME95#	D1	
B		2.2μF	±10%	GRM155B30J225KE95#			
			±20%	GRM155B30J225ME95#			
4Vdc	X7R	1.0μF	±10%	GRM155R70G105KA12#			
			±20%	GRM155R70G105MA12#			
0.6mm	50Vdc	X5R	0.47μF	±10%	GRM155R61H474KE11#	D1	
		35Vdc	X5R	1.0μF	±10%	GRM155R6YA105KE11#	D1
	25Vdc	X6S	1.0μF	±10%	GRM155C81E105KE11#	D1	
				±20%	GRM155C81E105ME11#	D1	
	16Vdc	X6S	1.0μF	±10%	GRM155C81C105KE11#		
				±20%	GRM155C81C105ME11#		
	6.3Vdc	X5R	4.7μF	±20%	GRM155R60J475ME47#	D1	
	4Vdc	X5R	4.7μF	±20%	GRM155R60G475ME47#		
	2.5Vdc	X6T	4.7μF	±20%	GRM155D80E475ME47#	D1	
0.65mm	25Vdc	X6T	2.2μF	±20%	GRM155D81E225ME11#	D1	
	16Vdc	X7T	2.2μF	±20%	GRM155D71C225ME11#	D1	
X6T	2.2μF	±20%	GRM155D81C225ME11#				

Part number # indicates the package specification code.

GRM Series High Dielectric Constant Type Part Number List

(→ 1.0×0.5mm)

T max.	Rated Voltage	TC Code	Cap.	Tol.	Part Number	
0.65mm	10Vdc	X7T	2.2µF	±20%	GRM155D71A225ME11#	
		X5R	4.7µF	±20%	GRM155R61A475MEAA#	D1
	6.3Vdc	X6S	4.7µF	±20%	GRM155C80J475MEAA#	D1
0.7mm	25Vdc	X5R	2.2µF	±10%	GRM155R61E225KE11#	
				±20%	GRM155R61E225ME11#	
	16Vdc	X6S	2.2µF	±10%	GRM155C81C225KE11#	
				±20%	GRM155C81C225ME11#	
		X5R	2.2µF	±10%	GRM155R61C225KE11#	
				±20%	GRM155R61C225ME11#	
	10Vdc	X7S	2.2µF	±10%	GRM155C71A225KE11#	
				±20%	GRM155C71A225ME11#	
	6.3Vdc	X6S	2.2µF	±10%	GRM155C81A225KE11#	
				±20%	GRM155C81A225ME11#	
		X7S	2.2µF	±10%	GRM155C70J225KE11#	
	4Vdc	X5R	10µF	±20%	GRM155R60J106ME05#	D1
±20%				GRM155R60G106ME01#		
X5R		10µF	±20%	GRM155R60E106ME16#		
			±20%	GRM155R60E106ME16#		
			±20%	GRM155R60E106ME16#		

1.6×0.8mm

T max.	Rated Voltage	TC Code	Cap.	Tol.	Part Number	
0.5mm	6.3Vdc	X5R	10µF	±20%	GRM185R60J106ME15#	D1
	4Vdc	X5R	10µF	±20%	GRM185R60G106ME15#	
0.55mm	16Vdc	X5R	4.7µF	±10%	GRM185R61C475KE11#	
				±20%	GRM185R61C475ME11#	
	10Vdc	X6S	4.7µF	±10%	GRM185C81A475KE11#	D1
0.9mm	25Vdc	X5R	2.2µF	±10%	GRM188R61E225KA12#	
				±20%	GRM188R61E225MA12#	
	B	2.2µF	±10%	GRM188B31E225KA12#		
0.95mm	16Vdc	X6S	2.2µF	±10%	GRM188C81C225KA12#	
				±20%	GRM188C81C225MA12#	
	10Vdc	X7R	2.2µF	±10%	GRM188R71A225KE15#	
				±20%	GRM188R71A225ME15#	
	6.3Vdc	X5R	10µF	±20%	GRM188R60J106ME47#	
				B	10µF	±20%
4Vdc	X5R	10µF	±20%	GRM188R60G106ME47#		
0.95mm	25Vdc	X5R	4.7µF	±10%	GRM188R61E475KE11#	
				±20%	GRM188R61E475ME11#	
	16Vdc	X6S	4.7µF	±10%	GRM188C81C475KE11#	
				±20%	GRM188C81C475ME11#	
	X5R	4.7µF	±10%	GRM188R61C475KE11#		
			±20%	GRM188R61C475ME11#		
			10µF	±10%	GRM188R61C106KAAL#	
B	4.7µF	±10%	GRM188B31C475KAAJ#	D1		
±20%	GRM188B31C475MAAJ#	D1				
10Vdc	X7S	4.7µF	±10%	GRM188C71A475KE11#		
±20%	GRM188C71A475ME11#					

T max.	Rated Voltage	TC Code	Cap.	Tol.	Part Number	
0.95mm	10Vdc	X5R	10µF	±10%	GRM188R61A106KAAL#	
				±20%	GRM188R61A106MAAL#	
		B	10µF	±20%	GRM188B31A106ME69#	D1
1.0mm	50Vdc	X5R	2.2µF	±10%	GRM188R61H225KE11#	
				±20%	GRM188R61H225ME11#	
	35Vdc	X6S	2.2µF	±10%	GRM188C8YA225KE11#	
				±20%	GRM188C8YA225ME11#	
		X5R	4.7µF	±10%	GRM188R6YA475KE15#	
				±20%	GRM188R6YA475ME15#	
	25Vdc	X7S	2.2µF	±10%	GRM188C71E225KE11#	
				±20%	GRM188C71E225ME11#	
		X6S	2.2µF	±10%	GRM188C81E225KE11#	
	±20%			GRM188C81E225ME11#		
	4.7µF			±10%	GRM188C81E475KE11#	D1
	16Vdc	X5R	10µF	±20%	GRM188R61E106MA73#	
±20%				GRM188R61E106MA73#		
X7S		2.2µF	±10%	GRM188C71C225KE11#		
			±20%	GRM188C71C225ME11#		
X6S		10µF	±10%	GRM188C71C475KE21#		
	±20%		GRM188C71C475KE21#			
10Vdc	X7T	10µF	±20%	GRM188D71A106MA73#		
6.3Vdc	X7T	10µF	±20%	GRM188D70J106MA73#		
			±20%	GRM188D70J106MA73#		
	X5R	22µF	±20%	GRM188R60J226MEA0#	D1	
			B	22µF	±20%	GRM188B30J226MEA0#
4Vdc	X6S	22µF	±20%	GRM188C80G226MEA0#	D1	
			X5R	22µF	±20%	GRM188R60G226MEA0#
B	22µF	±20%	GRM188B30G226MEA0#			

2.0×1.25mm

T max.	Rated Voltage	TC Code	Cap.	Tol.	Part Number	
0.95mm	35Vdc	X5R	4.7µF	±10%	GRM219R6YA475KA73#	D1
				±20%	GRM219R6YA475MA73#	D1
	25Vdc	X5R	4.7µF	±10%	GRM219R61E475KA73#	
				±20%	GRM219R61E475MA73#	
1.0mm	35Vdc	X6S	4.7µF	±10%	GRM219C8YA475KE21#	D1
				±20%	GRM219C8YA475ME21#	D1
1.0mm	25Vdc	X7S	4.7µF	±10%	GRM219C71E475KE21#	D1
				±20%	GRM219C71E475ME21#	D1
	X6S	4.7µF	±10%	GRM219C81E475KE21#	D1	
			±20%	GRM219C81E475ME21#	D1	
	16Vdc	X7S	4.7µF	±10%	GRM219C71C475KE21#	
				±20%	GRM219C71C475ME21#	
X5R	22µF	±20%	GRM219R61C226ME15#	D1		
1.35mm	16Vdc	X5R	10µF	±10%	GRM21BR61C106KE15#	
				±20%	GRM21BR61C106ME15#	
	B	10µF	±10%	GRM21BB31C106KE15#		
			±20%	GRM21BB31C106ME15#		
1.4mm	50Vdc	X5R	4.7µF	±10%	GRM21BR61H475KE51#	
				±20%	GRM21BR61H475ME51#	
B	4.7µF	±10%	GRM21BB31H475KE51#			

Part number # indicates the package specification code.



GRM Series High Dielectric Constant Type Part Number List

(→ 2.0×1.25mm)

T max.	Rated Voltage	TC Code	Cap.	Tol.	Part Number	
1.4mm	50Vdc	B	4.7μF	±20%	GRM21BB31H475ME51#	
		X7R	2.2μF	±10%	GRM21BR71E225KE11#	
				±20%	GRM21BR71E225ME11#	
				X5R	10μF	±10%
		±20%	GRM21BR61E106MA73#			
		B	10μF			±10%
	±20%			GRM21BB31E106MA73#		
	16Vdc	X6S	10μF	±10%	GRM21BC81C106KA73#	
				±20%	GRM21BC81C106MA73#	
	4Vdc	X7U	22μF	±20%	GRM21BE70G226ME51#	
	1.45mm	100Vdc	X7S	1.0μF	±10%	GRM21BC72A105KE01#
					±20%	GRM21BC72A105ME11#
50Vdc		X7S	4.7μF	±10%	GRM21BC71H475KE11#	
				±20%	GRM21BC71H475ME11#	
				X6S	4.7μF	±10%
		±20%	GRM21BC81H475ME11#			
		X7S	4.7μF			±10%
				±20%	GRM21BC7YA475ME11#	
X6S		10μF	±10%	GRM21BC8YA106KE11# D1		
			±20%	GRM21BC8YA106ME11# D1		
			X5R	10μF	±10%	GRM21BR6YA106KE43# D1
±20%		GRM21BR6YA106ME43# D1				
25Vdc		X7S	4.7μF	±10%	GRM21BC71E475KE11#	
				±20%	GRM21BC71E475ME11#	
				10μF	±10%	GRM21BC71E106KE11# D1
		±20%	GRM21BC71E106ME11# D1			
		X6S	10μF		±10%	GRM21BC81E106KE11# D1
				±20%	GRM21BC81E106ME11# D1	
X5R		22μF	±20%	GRM21BR61E226ME44#		
			16Vdc	X7S	10μF	±10%
±20%		GRM21BC71C106ME11#				
X6S		22μF		±20%	GRM21BC81C226ME44# D1	
			X5R	22μF	±20%	GRM21BR61C226ME44#
10Vdc		X7T			22μF	±20%
	X6S		22μF	±20%		GRM21BC81A226ME44#
		X5R		22μF	±20%	GRM21BR61A226ME44#
	47μF		±20%		GRM21BR61A476ME15# D1	
6.3Vdc	X7T	22μF	±20%	GRM21BD70J226ME44#		
			X5R	47μF	±20%	GRM21BR60J476ME01# D1
	100μF	±20%			GRM21BR60J107ME15# D1	
		B	47μF	±20%	GRM21BB30J476ME15# D1	
4Vdc	X6S			47μF	±20%	GRM21BC80G476ME15# D1
		100μF	±20%		GRM21BC80G107ME15# D1	
	X5R		47μF	±20%	GRM21BR60G476ME01#	
		B		47μF	±20%	GRM21BB30G476ME15#
2.5Vdc	X6S		100μF		±20%	GRM21BC80E107ME15#

3.2×1.6mm

T max.	Rated Voltage	TC Code	Cap.	Tol.	Part Number
0.95mm	16Vdc	X5R	22μF	±20%	GRM319R61C226ME15# D1
				±20%	GRM319B31C226ME15# D1
1.8mm	50Vdc	X7R	4.7μF	±10%	GRM31CR71H475KA12#
				±20%	GRM31CR71H475MA12#

T max.	Rated Voltage	TC Code	Cap.	Tol.	Part Number	
1.8mm	25Vdc	X7R	10μF	±10%	GRM31CR71E106KA12#	
				±20%	GRM31CR71E106MA12#	
		X7R	22μF	±20%	GRM31CR71A226ME15#	
				X5R	47μF	±20%
		6.3Vdc	X7R			22μF
				X7U	47μF	
	X5R	47μF	±20%			GRM31CR60J476ME19#
			4Vdc	X7U	47μF	±20%
	1.9mm	100Vdc				X7S
			±20%	GRM31CC72A475ME11#		
		50Vdc	X7T	10μF	±10%	GRM31CD71H106KE11# D1
					±10%	GRM31CD71A106KE11#
35Vdc		X7T	10μF	±10%	GRM31CD7YA106KE11#	
				25Vdc	X6S	22μF
16Vdc		X7S	22μF			
				X5R	47μF	±20%
10Vdc		X6S	47μF			±20%
				X5R	100μF	±20%
6.3Vdc		X6T	100μF			±20%
				X5R	100μF	±20%
220μF	±20%	GRM31CR60J227ME11# D1				
	4Vdc	X7U	100μF	±20%	GRM31CE70G107ME48# D1	
X6T				100μF	±20%	GRM31CD80G107ME48#
		X5R	100μF		±20%	GRM31CR60G107ME48#
220μF				±20%	GRM31CR60G227ME11#	
2.5Vdc	X5R	220μF	±20%	GRM31CR60E227ME11#		

3.2×2.5mm

T max.	Rated Voltage	TC Code	Cap.	Tol.	Part Number	
2.7mm	100Vdc	X7S	10μF	±10%	GRM32EC72A106KE05#	
				±20%	GRM32EC72A106ME05#	
	25Vdc	X7R	22μF	±20%	GRM32ER71E226ME15#	
				16Vdc	X7R	22μF
	X6S	47μF	±20%			
			10Vdc	X7R	47μF	±20%
	X5R	100μF				±20%
			6.3Vdc	X7R	47μF	±20%
	X7U	100μF				±20%
			4Vdc	X7U	100μF	±20%
	2.8mm	6.3Vdc				X5R
			4Vdc	X5R	220μF	

4.5×3.2mm

T max.	Rated Voltage	TC Code	Cap.	Tol.	Part Number
1.5mm	630Vdc	X7R	68000pF	±10%	GRM43QR72J683KW01#
				±10%	GRM43QR72H154KW10#
				±10%	GRM43QR72E154KW01#
2.0mm	1000Vdc	X7R	33000pF	±10%	GRM43DR73A333KW01#
				±10%	GRM43DR73A473KW01#
	630Vdc	X7R	0.10μF	±10%	GRM43DR72J104KW01#
				±10%	GRM43DR72H224KW10#

Part number # indicates the package specification code.

GRM Series High Dielectric Constant Type Part Number List

(→ 4.5×3.2mm)

T max.	Rated Voltage	TC Code	Cap.	Tol.	Part Number
2.0mm	250Vdc	X7R	0.22μF	±10%	GRM43DR72E224KW01#
			0.33μF	±10%	GRM43DR72E334KW01#
			0.47μF	±10%	GRM43DR72E474KW01#

5.7×5.0mm

T max.	Rated Voltage	TC Code	Cap.	Tol.	Part Number
2.0mm	1000Vdc	X7R	68000pF	±10%	GRM55DR73A683KW01#
			0.10μF	±10%	GRM55DR73A104KW01#
	630Vdc	X7R	0.15μF	±10%	GRM55DR72J154KW01#
			0.22μF	±10%	GRM55DR72J224KW01#
	500Vdc	X7R	0.33μF	±10%	GRM55DR72H334KW10#
			0.47μF	±10%	GRM55DR72H474KW10#
	250Vdc	X7R	0.33μF	±10%	GRM55DR72E334KW01#
			0.47μF	±10%	GRM55DR72E474KW01#
			0.68μF	±10%	GRM55DR72E684KW01#
			1.0μF	±10%	GRM55DR72E105KW01#
	200Vdc	X7R	0.33μF	±10%	GRM55DR72D334KW01#
			0.47μF	±10%	GRM55DR72D474KW01#
			0.68μF	±10%	GRM55DR72D684KW01#
			1.0μF	±10%	GRM55DR72D105KW01#

- GRM
- GR3
- GRJ
- GR4
- GJM
- GQM
- GA2
- GA3 GB
- GA3 GD
- GA3 GF
- LLL
- LLA
- LLM
- LLR
- NFM
- KRM
- KR3
- GMA
- GMD
- ⚠Caution /Notice

Part number # indicates the package specification code.

High Effective Capacitance & High Ripple Current Chip Multilayer Ceramic Capacitors for General Purpose

GR3 Series



Anti-noise

WEB

This is a general purpose high ripple resistance product excellent in DC bias characteristics.

Features

- 1 When a DC bias is applied, a capacitance higher than conventional products (X7R characteristics) can be acquired.

About twice the capacitance can be secured when DC200V is applied.

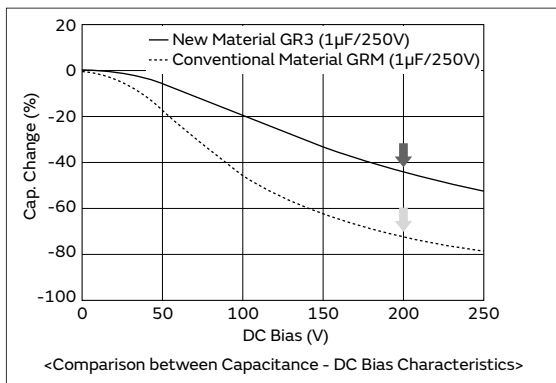

- 2 Improved ripple resistance performance compared to conventional products (X7R characteristics).

In the case of a product with a capacitance of 1μF, when the exothermic temperature reaches 20°C at frequency f=300kHz, the amount of resistance of a product with conventional material is 2.9Arms; however, the new material is 4.7Arms.

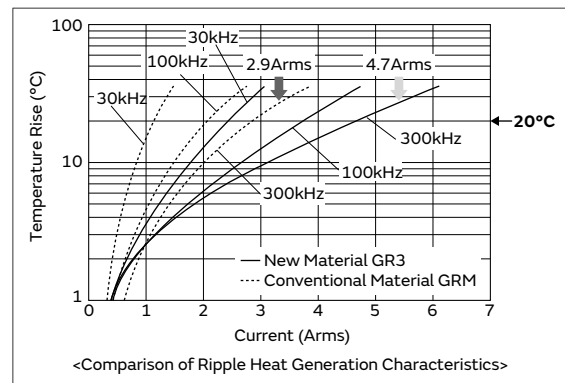

- 3 This product has a noise reduction effect.

Since dielectric materials which enable a reduction of noise are used, this product is more effective for reducing noise compared to the general purpose GRM series.

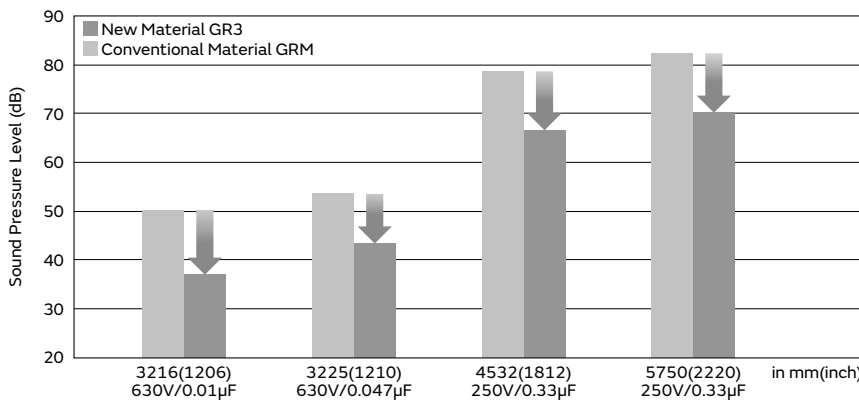

Specifications

Size (mm)	2.0×1.25mm to 5.7×5.0mm
Rated Voltage	250Vdc to 630Vdc
Capacitance	10000pF to 1.0μF
Main Applications	For PFC (Power Factor Correction) Circuits of Power Supplies, EMI Suppression and Smoothing Circuits

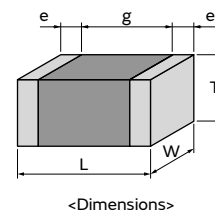

This catalog contains only a portion of the product lineup. Please refer to the capacitor search tool on the Murata Web site for details.

GRM
 GR3
 GRJ
 GR4
 GJM
 GQM
 GA2
 GA3 GB
 GA3 GD
 GA3 GF
 LLL
 LLA
 LLM
 LLR
 NFM
 KRM
 KR3
 GMA
 GMD
 ⚠Caution / Notice

GR3 Series High Dielectric Constant Type Anti-noise Part Number List

2.0×1.25mm

T max.	Rated Voltage	TC Code	Cap.	Tol.	Part Number
1.0mm	250Vdc	X7T	10000pF	±10%	GR321AD72E103KW01#
			15000pF	±10%	GR321AD72E153KW01#
1.45mm	250Vdc	X7T	22000pF	±10%	GR321BD72E223KW03#

T max.	Rated Voltage	TC Code	Cap.	Tol.	Part Number
2.7mm	250Vdc	X7T	1.0μF	±10%	GR355XD72E105KW05#

3.2×1.6mm

T max.	Rated Voltage	TC Code	Cap.	Tol.	Part Number
1.0mm	450Vdc	X7T	10000pF	±10%	GR331AD72W103KW01#
			15000pF	±10%	GR331AD72W153KW01#
	250Vdc	X7T	33000pF	±10%	GR331AD72E333KW01#
1.25mm	630Vdc	X7T	10000pF	±10%	GR331BD72J103KW01#
	450Vdc	X7T	22000pF	±10%	GR331BD72W223KW01#
			33000pF	±10%	GR331BD72W333KW01#
	250Vdc	X7T	47000pF	±10%	GR331BD72E473KW01#
1.8mm	630Vdc	X7T	15000pF	±10%	GR331CD72J153KW03#
	450Vdc	X7T	47000pF	±10%	GR331CD72W473KW03#
	250Vdc	X7T	68000pF	±10%	GR331CD72E683KW03#

3.2×2.5mm

T max.	Rated Voltage	TC Code	Cap.	Tol.	Part Number
1.5mm	630Vdc	X7T	22000pF	±10%	GR332QD72J223KW01#
	250Vdc	X7T	0.10μF	±10%	GR332QD72E104KW01#
2.0mm	630Vdc	X7T	33000pF	±10%	GR332DD72J333KW01#
			47000pF	±10%	GR332DD72J473KW01#
	450Vdc	X7T	68000pF	±10%	GR332DD72W683KW01#
			0.10μF	±10%	GR332DD72W104KW01#
	250Vdc	X7T	0.15μF	±10%	GR332DD72E154KW01#

4.5×3.2mm

T max.	Rated Voltage	TC Code	Cap.	Tol.	Part Number
1.5mm	250Vdc	X7T	0.22μF	±10%	GR343QD72E224KW01#
2.0mm	630Vdc	X7T	68000pF	±10%	GR343DD72J683KW01#
	450Vdc	X7T	0.15μF	±10%	GR343DD72W154KW01#
	250Vdc	X7T	0.33μF	±10%	GR343DD72E334KW01#

5.7×5.0mm

T max.	Rated Voltage	TC Code	Cap.	Tol.	Part Number
2.0mm	630Vdc	X7T	0.10μF	±10%	GR355DD72J104KW01#
			0.15μF	±10%	GR355DD72J154KW01#
	450Vdc	X7T	0.22μF	±10%	GR355DD72W224KW01#
			0.33μF	±10%	GR355DD72W334KW01#
			0.47μF	±10%	GR355DD72W474KW01#
	250Vdc	X7T	0.47μF	±10%	GR355DD72E474KW01#
0.68μF			±10%	GR355DD72E684KW01#	
2.7mm	630Vdc	X7T	0.22μF	±10%	GR355XD72J224KW05#

Part number # indicates the package specification code.

GRM
 GR3
 GRJ
 GR4
 GJM
 GQM
 GA2
 GA3 GB
 GA3 GD
 GA3 GF
 LLL
 LLA
 LLM
 LLR
 NFM
 KRM
 KR3
 GMA
 GMD
 ⚠Caution /Notice

Soft Termination Chip Multilayer Ceramic Capacitors for General Purpose

GRJ Series



Cracking caused by flexing stress after board mounting is minimized due to resin external electrodes!

Features

① The resin external electrodes suppress cracks by board deflection.

Cracking of the ceramic element is suppressed by the resin of the external electrodes, which releases the stress.

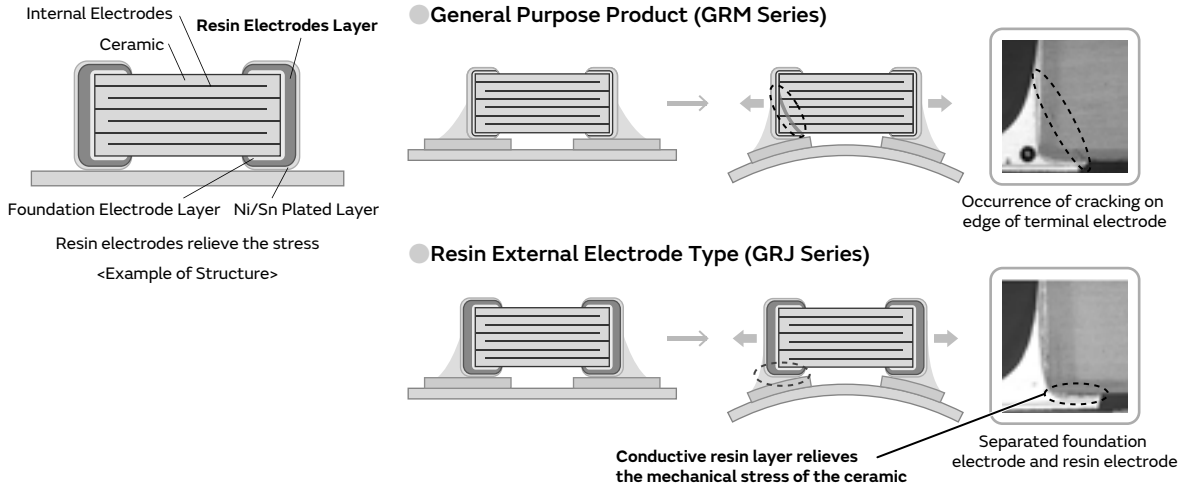

Note: Cracks may occur in the capacitor body if excessive stress beyond the "guaranteed range of board bending strength (*)" provided in the specifications is applied. Capacitors with cracks in them may cause a drop in insulation resistance, which could lead to a short circuit.
 (*) For details on the guaranteed range of board bending strength, check the "Detailed Specification Sheet" on the Product Details Page.

② Suppresses the occurrence of cracking caused by deflection stress at the time of board mounting, etc.

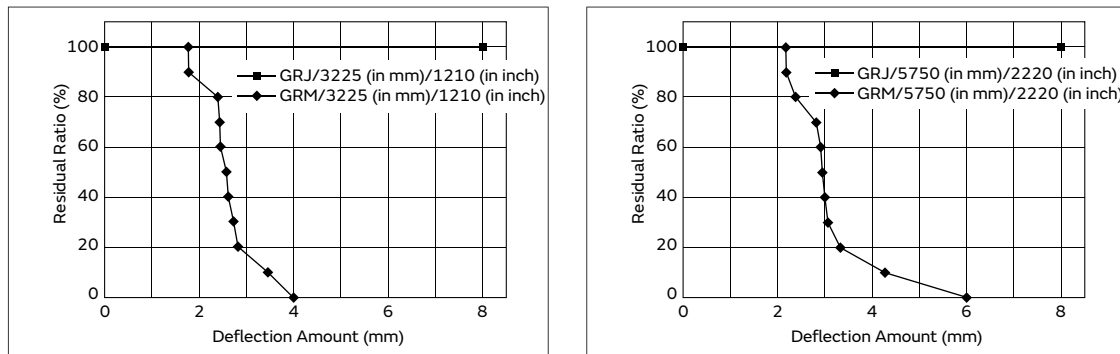

Due to the specification of the measuring instrument, measurements can be performed up to 8mm.

③ Ideal for consumer and industrial electronic equipment, etc. where there heat stress, vibration and impact are applied.

Specifications

Size (mm)	0.6×0.3mm to 5.7×5.0mm
Rated Voltage	6.3Vdc to 1000Vdc
Capacitance	33000pF to 47μF
Main Applications	Consumer & Industrial Electronic Equipment

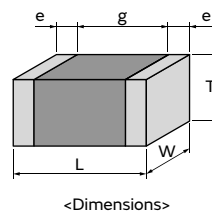

This catalog contains only a portion of the product lineup.
 Please refer to the capacitor search tool on the Murata Web site for details.

GRJ Series High Dielectric Constant Type Part Number List

2.0×1.25mm

T max.	Rated Voltage	TC Code	Cap.	Tol.	Part Number	
1.45mm	25Vdc	X5R	10µF	±10%	GRJ21BR61E106KE01#	D1
1.5mm	100Vdc	X7S	1.0µF	±10%	GRJ21BC72A105KE11#	

3.2×1.6mm

T max.	Rated Voltage	TC Code	Cap.	Tol.	Part Number	
1.9mm	100Vdc	X7S	4.7µF	±10%	GRJ31CC72A475KE01#	
				±20%	GRJ31CC72A475ME01#	
	50Vdc	X7R	4.7µF	±10%	GRJ31CR71H475KE11#	

3.2×2.5mm

T max.	Rated Voltage	TC Code	Cap.	Tol.	Part Number	
2.8mm	10Vdc	X7R	47µF	±20%	GRJ32ER71A476ME11#	
2.85mm	25Vdc	X7S	22µF	±10%	GRJ32EC71E226KE11#	

4.5×3.2mm

T max.	Rated Voltage	TC Code	Cap.	Tol.	Part Number	
1.5mm	630Vdc	X7R	68000pF	±10%	GRJ43QR72J683KWJ1#	
	250Vdc	X7R	0.15µF	±10%	GRJ43QR72E154KWJ1#	
2.0mm	1000Vdc	X7R	33000pF	±10%	GRJ43DR73A333KWJ1#	
			47000pF	±10%	GRJ43DR73A473KWJ1#	
	630Vdc	X7R	0.10µF	±10%	GRJ43DR72J104KWJ1#	
	250Vdc	X7R	0.22µF	±10%	GRJ43DR72E224KWJ1#	
			0.33µF	±10%	GRJ43DR72E334KWJ1#	
			0.47µF	±10%	GRJ43DR72E474KWJ1#	

5.7×5.0mm

T max.	Rated Voltage	TC Code	Cap.	Tol.	Part Number	
2.0mm	1000Vdc	X7R	68000pF	±10%	GRJ55DR73A683KWJ1#	
			0.10µF	±10%	GRJ55DR73A104KWJ1#	
	630Vdc	X7R	0.15µF	±10%	GRJ55DR72J154KWJ1#	
			0.22µF	±10%	GRJ55DR72J224KWJ1#	
	250Vdc	X7R	0.33µF	±10%	GRJ55DR72E334KWJ1#	
			0.47µF	±10%	GRJ55DR72E474KWJ1#	
			0.68µF	±10%	GRJ55DR72E684KWJ1#	
			1.0µF	±10%	GRJ55DR72E105KWJ1#	

- GRM
- GR3
- GRJ**
- GR4
- GJM
- GQM
- GA2
- GA3 GB
- GA3 GD
- GA3 GF
- LLL
- LLA
- LLM
- LLR
- NFM
- KRM
- KR3
- GMA
- GMD
- ⚠Caution /Notice

Chip Multilayer Ceramic Capacitors for Information Devices Only

GR4 Series



Size (L*W) : 4.5x2.0mm - 5.7x5.0mm / X7R Char. / DC2kV
Realized large capacity and small size while maintaining high withstand voltages by the multilayer structure.

Features

- 1 For information devices of Ethernet LAN (IEEE802.3.) and primary - secondary couplings of DC-DC converters.

ex) DC-DC Converter

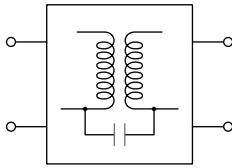

ex) LAN Connector

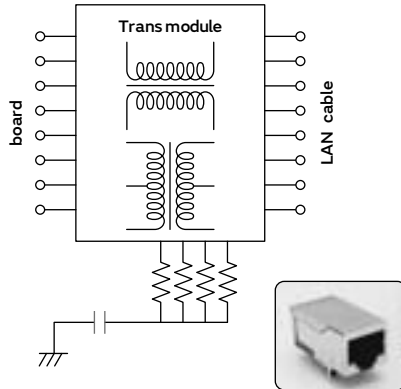

- 2 Realized large capacity and small size while maintaining high withstand voltages by the multilayer structure.

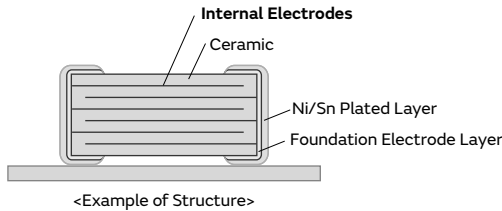

- 3 Dedicated for reflow soldering.

Specifications

Size (mm)	4.5×2.0mm to 5.7×5.0mm
Rated Voltage	2000Vdc
Capacitance	100pF to 10000pF
Main Applications	For Ethernet LAN, Primary-secondary coupling for DC-DC converters

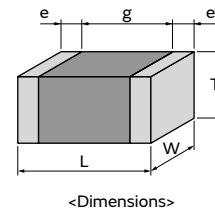

This catalog contains only a portion of the product lineup.
 Please refer to the capacitor search tool on the Murata Web site for details.

- GRM
- GR3
- GRJ
- GR4**
- GJM
- GQM
- GA2
- GA3 GB
- GA3 GD
- GA3 GF
- LLL
- LLA
- LLM
- LLR
- NFM
- KRM
- KR3
- GMA
- GMD
- ⚠Caution / Notice

GR4 Series Temperature Compensating Type Part Number List

3.2×1.6mm

T max.	Rated Voltage	TC Code	Cap.	Tol.	Part Number	
1.0mm	630Vdc	U2J	1000pF	±5%	GR431A7U2J102JWC2#	
			1500pF	±5%	GR431A7U2J152JWC2#	
			2200pF	±5%	GR431A7U2J222JWC2#	
1.25mm	630Vdc	U2J	3300pF	±5%	GR431B7U2J332JWC2#	
1.8mm	630Vdc	U2J	4700pF	±5%	GR431C7U2J472JWC1#	

3.2×2.5mm

T max.	Rated Voltage	TC Code	Cap.	Tol.	Part Number	
1.5mm	630Vdc	U2J	6800pF	±5%	GR432Q7U2J682JWC2#	
2.0mm	630Vdc	U2J	10000pF	±5%	GR432D7U2J103JWC2#	
2.7mm	630Vdc	U2J	15000pF	±5%	GR432E7U2J153JWC1#	

GRM

GR3

GRJ

GR4

GJM

GQM

GA2

GA3
GB

GA3
GD

GA3
GF

LLL

LLA

LLM

LLR

NFM

KRM

KR3

GMA

GMD

⚠Caution
/Notice

GR4 Series High Dielectric Constant Type Part Number List

4.5×2.0mm

T max.	Rated Voltage	TC Code	Cap.	Tol.	Part Number
1.5mm	2000Vdc	X7R	100pF	±10%	GR442QR73D101KW01#
			120pF	±10%	GR442QR73D121KW01#
			150pF	±10%	GR442QR73D151KW01#
			180pF	±10%	GR442QR73D181KW01#
			220pF	±10%	GR442QR73D221KW01#
			270pF	±10%	GR442QR73D271KW01#
			330pF	±10%	GR442QR73D331KW01#
			390pF	±10%	GR442QR73D391KW01#
			470pF	±10%	GR442QR73D471KW01#
			560pF	±10%	GR442QR73D561KW01#
			680pF	±10%	GR442QR73D681KW01#
			820pF	±10%	GR442QR73D821KW01#
			1000pF	±10%	GR442QR73D102KW01#
1200pF	±10%	GR442QR73D122KW01#			
1500pF	±10%	GR442QR73D152KW01#			

4.5×3.2mm

T max.	Rated Voltage	TC Code	Cap.	Tol.	Part Number
1.5mm	2000Vdc	X7R	1800pF	±10%	GR443QR73D182KW01#
			2200pF	±10%	GR443QR73D222KW01#
			2700pF	±10%	GR443QR73D272KW01#
			3300pF	±10%	GR443QR73D332KW01#
			3900pF	±10%	GR443QR73D392KW01#
2.0mm	2000Vdc	X7R	4700pF	±10%	GR443DR73D472KW01#

5.7×5.0mm

T max.	Rated Voltage	TC Code	Cap.	Tol.	Part Number
2.0mm	2000Vdc	X7R	10000pF	±10%	GR455DR73D103KW01#

- GRM
- GR3
- GRJ
- GR4**
- GJM
- GQM
- GA2
- GA3 GB
- GA3 GD
- GA3 GF
- LLL
- LLA
- LLM
- LLR
- NFM
- KRM
- KR3
- GMA
- GMD
- ⚠Caution /Notice

High Q Chip Multilayer Ceramic Capacitors for General Purpose

GJM Series



This product improves the high frequency characteristics and contributes to a reduction of power consumption by the High Q and low ESR.

Features

① **Mainly ideal for mobile communication devices and temperature compensation of related modules.**

This product is ideal for temperature compensation of high frequency circuits, such as resonant circuits, tuning circuits, and impedance matching circuits where the operating characteristics of the device are greatly affected by the capacitance fluctuation.

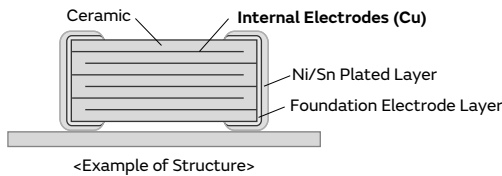

② **High Q and low ESR in VHF, UHF and microwave frequency bands.**

High Q and low ESR were achieved at a high frequency by adopting ceramic material as the dielectric material which enables an extremely low loss at high frequency, and base metal electrodes as the internal electrodes.

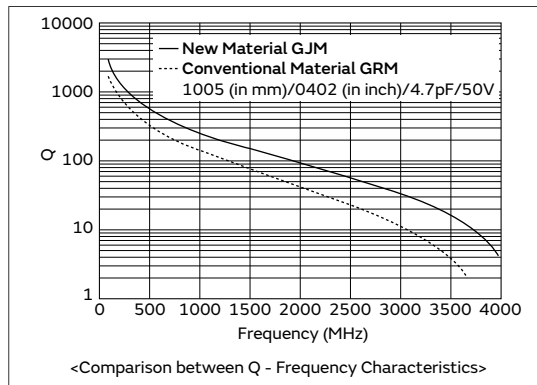
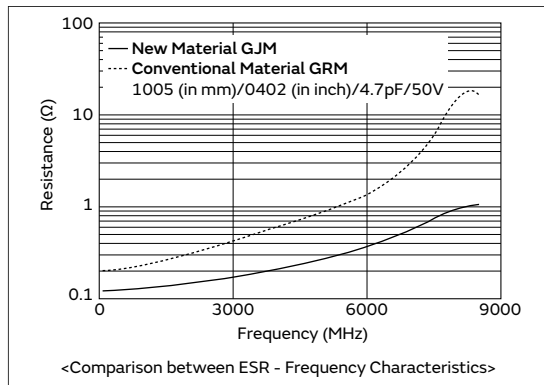

③ **Can be used for tight tolerance.**

In addition to standard tolerance, the allowable range of this product is also suitable for the following tight tolerance.

Capacitance Range	Standard Capacitance Tolerance (Capacitance Tolerance Symbol)	Narrow Capacitance Tolerance (Capacitance Tolerance Symbol)
to 0.9pF	±0.1pF (B)	±0.05pF (W)
1.0 to 5.0pF	±0.25pF (C)	±0.05pF (W), ±0.1pF (B)
5.1 to 9.9pF	±0.5pF (D)	±0.05pF (W), ±0.1pF (B), ±0.25pF (C)
10pF to	±5% (J)	±2% (G)

Specifications

Size (mm)	0.4×0.2mm to 1.0×0.5mm
Rated Voltage	6.3Vdc to 100Vdc
Capacitance	0.10pF to 47pF
Main Applications	Small communication devices, such as mobile phones and high frequency communication modules

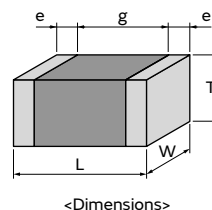

This catalog contains only a portion of the product lineup.
 Please refer to the capacitor search tool on the Murata Web site for details.

GJM Series Temperature Compensating Type High Q Part Number List

0.4×0.2mm

T max.	Rated Voltage	TC Code	Cap.	Tol.	Part Number
0.22mm	25Vdc	COG	0.20pF	±0.1pF	GJM0225C1ER20BB01#
			0.30pF	±0.1pF	GJM0225C1ER30BB01#
			0.40pF	±0.1pF	GJM0225C1ER40BB01#
			0.50pF	±0.1pF	GJM0225C1ER50BB01#
			0.60pF	±0.1pF	GJM0225C1ER60BB01#
			0.70pF	±0.1pF	GJM0225C1ER70BB01#
			0.80pF	±0.1pF	GJM0225C1ER80BB01#
			0.90pF	±0.1pF	GJM0225C1ER90BB01#
			1.0pF	±0.25pF	GJM0225C1E1R0CB01#
			1.1pF	±0.25pF	GJM0225C1E1R1CB01#
			1.2pF	±0.25pF	GJM0225C1E1R2CB01#
			1.3pF	±0.25pF	GJM0225C1E1R3CB01#
			1.4pF	±0.25pF	GJM0225C1E1R4CB01#
			1.5pF	±0.25pF	GJM0225C1E1R5CB01#
			1.6pF	±0.25pF	GJM0225C1E1R6CB01#
			1.7pF	±0.25pF	GJM0225C1E1R7CB01#
			1.8pF	±0.25pF	GJM0225C1E1R8CB01#
			1.9pF	±0.25pF	GJM0225C1E1R9CB01#
			2.0pF	±0.25pF	GJM0225C1E2R0CB01#
			2.1pF	±0.25pF	GJM0225C1E2R1CB01#
			2.2pF	±0.25pF	GJM0225C1E2R2CB01#
			2.3pF	±0.25pF	GJM0225C1E2R3CB01#
			2.4pF	±0.25pF	GJM0225C1E2R4CB01#
			2.5pF	±0.25pF	GJM0225C1E2R5CB01#
			2.6pF	±0.25pF	GJM0225C1E2R6CB01#
			2.7pF	±0.25pF	GJM0225C1E2R7CB01#
			2.8pF	±0.25pF	GJM0225C1E2R8CB01#
			2.9pF	±0.25pF	GJM0225C1E2R9CB01#
			3.0pF	±0.25pF	GJM0225C1E3R0CB01#
			3.1pF	±0.25pF	GJM0225C1E3R1CB01#
			3.2pF	±0.25pF	GJM0225C1E3R2CB01#
			3.3pF	±0.25pF	GJM0225C1E3R3CB01#
			3.4pF	±0.25pF	GJM0225C1E3R4CB01#
			3.5pF	±0.25pF	GJM0225C1E3R5CB01#
			3.6pF	±0.25pF	GJM0225C1E3R6CB01#
			3.7pF	±0.25pF	GJM0225C1E3R7CB01#
			3.8pF	±0.25pF	GJM0225C1E3R8CB01#
			3.9pF	±0.25pF	GJM0225C1E3R9CB01#
			4.0pF	±0.25pF	GJM0225C1E4R0CB01#
			4.1pF	±0.25pF	GJM0225C1E4R1CB01#
			4.2pF	±0.25pF	GJM0225C1E4R2CB01#
			4.3pF	±0.25pF	GJM0225C1E4R3CB01#
			4.4pF	±0.25pF	GJM0225C1E4R4CB01#
			4.5pF	±0.25pF	GJM0225C1E4R5CB01#
			4.6pF	±0.25pF	GJM0225C1E4R6CB01#
			4.7pF	±0.25pF	GJM0225C1E4R7CB01#
			4.8pF	±0.25pF	GJM0225C1E4R8CB01#
			4.9pF	±0.25pF	GJM0225C1E4R9CB01#
			5.0pF	±0.25pF	GJM0225C1E5R0CB01#
			5.1pF	±0.5pF	GJM0225C1E5R1DB01#
			5.2pF	±0.5pF	GJM0225C1E5R2DB01#
			5.3pF	±0.5pF	GJM0225C1E5R3DB01#

T max.	Rated Voltage	TC Code	Cap.	Tol.	Part Number
0.22mm	25Vdc	COG	5.4pF	±0.5pF	GJM0225C1E5R4DB01#
			5.5pF	±0.5pF	GJM0225C1E5R5DB01#
			5.6pF	±0.5pF	GJM0225C1E5R6DB01#
			5.7pF	±0.5pF	GJM0225C1E5R7DB01#
			5.8pF	±0.5pF	GJM0225C1E5R8DB01#
			5.9pF	±0.5pF	GJM0225C1E5R9DB01#
			6.0pF	±0.5pF	GJM0225C1E6R0DB01#
			6.1pF	±0.5pF	GJM0225C1E6R1DB01#
			6.2pF	±0.5pF	GJM0225C1E6R2DB01#
			6.3pF	±0.5pF	GJM0225C1E6R3DB01#
			6.4pF	±0.5pF	GJM0225C1E6R4DB01#
			6.5pF	±0.5pF	GJM0225C1E6R5DB01#
			6.6pF	±0.5pF	GJM0225C1E6R6DB01#
			6.7pF	±0.5pF	GJM0225C1E6R7DB01#
			6.8pF	±0.5pF	GJM0225C1E6R8DB01#
			6.9pF	±0.5pF	GJM0225C1E6R9DB01#
			7.0pF	±0.5pF	GJM0225C1E7R0DB01#
			7.1pF	±0.5pF	GJM0225C1E7R1DB01#
			7.2pF	±0.5pF	GJM0225C1E7R2DB01#
			7.3pF	±0.5pF	GJM0225C1E7R3DB01#
			7.4pF	±0.5pF	GJM0225C1E7R4DB01#
			7.5pF	±0.5pF	GJM0225C1E7R5DB01#
			7.6pF	±0.5pF	GJM0225C1E7R6DB01#
			7.7pF	±0.5pF	GJM0225C1E7R7DB01#
			7.8pF	±0.5pF	GJM0225C1E7R8DB01#
			7.9pF	±0.5pF	GJM0225C1E7R9DB01#
			8.0pF	±0.5pF	GJM0225C1E8R0DB01#
			8.1pF	±0.5pF	GJM0225C1E8R1DB01#
			8.2pF	±0.5pF	GJM0225C1E8R2DB01#
			8.3pF	±0.5pF	GJM0225C1E8R3DB01#
			8.4pF	±0.5pF	GJM0225C1E8R4DB01#
			8.5pF	±0.5pF	GJM0225C1E8R5DB01#
			8.6pF	±0.5pF	GJM0225C1E8R6DB01#
			8.7pF	±0.5pF	GJM0225C1E8R7DB01#
			8.8pF	±0.5pF	GJM0225C1E8R8DB01#
			8.9pF	±0.5pF	GJM0225C1E8R9DB01#
			9.0pF	±0.5pF	GJM0225C1E9R0DB01#
			9.1pF	±0.5pF	GJM0225C1E9R1DB01#
			9.2pF	±0.5pF	GJM0225C1E9R2DB01#
			9.3pF	±0.5pF	GJM0225C1E9R3DB01#
			9.4pF	±0.5pF	GJM0225C1E9R4DB01#
			9.5pF	±0.5pF	GJM0225C1E9R5DB01#
			9.6pF	±0.5pF	GJM0225C1E9R6DB01#
			9.7pF	±0.5pF	GJM0225C1E9R7DB01#
			9.8pF	±0.5pF	GJM0225C1E9R8DB01#
			9.9pF	±0.5pF	GJM0225C1E9R9DB01#
			10pF	±5%	GJM0225C1E100JB01#
			11pF	±5%	GJM0225C1E110JB01#
			12pF	±5%	GJM0225C1E120JB01#
			13pF	±5%	GJM0225C1E130JB01#
			15pF	±5%	GJM0225C1E150JB01#
			16pF	±5%	GJM0225C1E160JB01#
			18pF	±5%	GJM0225C1E180JB01#
			20pF	±5%	GJM0225C1E200JB01#

- GRM
- GR3
- GRJ
- GR4
- GJM
- GQM
- GA2
- GA3 GB
- GA3 GD
- GA3 GF
- LLL
- LLA
- LLM
- LLR
- NFM
- KRM
- KR3
- GMA
- GMD
- ⚠Caution /Notice

Part number # indicates the package specification code.

GJM Series Temperature Compensating Type High Q Part Number List

(→ 0.4×0.2mm)

T max.	Rated Voltage	TC Code	Cap.	Tol.	Part Number	T max.	Rated Voltage	TC Code	Cap.	Tol.	Part Number
0.22mm	25Vdc	COG	22pF	±5%	GJM0225C1E220JB01#	0.22mm	25Vdc	CH	5.5pF	±0.5pF	GJM0222C1E5R5DB01#
			0.20pF	±0.1pF	GJM0224C1ER20BB01#				5.6pF	±0.5pF	GJM0222C1E5R6DB01#
		0.30pF	±0.1pF	GJM0224C1ER30BB01#	5.7pF				±0.5pF	GJM0222C1E5R7DB01#	
		0.40pF	±0.1pF	GJM0224C1ER40BB01#	5.8pF				±0.5pF	GJM0222C1E5R8DB01#	
		0.50pF	±0.1pF	GJM0224C1ER50BB01#	5.9pF				±0.5pF	GJM0222C1E5R9DB01#	
		0.60pF	±0.1pF	GJM0224C1ER60BB01#	6.0pF				±0.5pF	GJM0222C1E6R0DB01#	
		0.70pF	±0.1pF	GJM0224C1ER70BB01#	6.1pF				±0.5pF	GJM0222C1E6R1DB01#	
		0.80pF	±0.1pF	GJM0224C1ER80BB01#	6.2pF				±0.5pF	GJM0222C1E6R2DB01#	
		0.90pF	±0.1pF	GJM0224C1ER90BB01#	6.3pF				±0.5pF	GJM0222C1E6R3DB01#	
		1.0pF	±0.25pF	GJM0224C1E1R0CB01#	6.4pF				±0.5pF	GJM0222C1E6R4DB01#	
		1.1pF	±0.25pF	GJM0224C1E1R1CB01#	6.5pF				±0.5pF	GJM0222C1E6R5DB01#	
		1.2pF	±0.25pF	GJM0224C1E1R2CB01#	6.6pF				±0.5pF	GJM0222C1E6R6DB01#	
		1.3pF	±0.25pF	GJM0224C1E1R3CB01#	6.7pF				±0.5pF	GJM0222C1E6R7DB01#	
		1.4pF	±0.25pF	GJM0224C1E1R4CB01#	6.8pF				±0.5pF	GJM0222C1E6R8DB01#	
		1.5pF	±0.25pF	GJM0224C1E1R5CB01#	6.9pF				±0.5pF	GJM0222C1E6R9DB01#	
		1.6pF	±0.25pF	GJM0224C1E1R6CB01#	7.0pF				±0.5pF	GJM0222C1E7R0DB01#	
		1.7pF	±0.25pF	GJM0224C1E1R7CB01#	7.1pF				±0.5pF	GJM0222C1E7R1DB01#	
		1.8pF	±0.25pF	GJM0224C1E1R8CB01#	7.2pF				±0.5pF	GJM0222C1E7R2DB01#	
		1.9pF	±0.25pF	GJM0224C1E1R9CB01#	7.3pF				±0.5pF	GJM0222C1E7R3DB01#	
		2.0pF	±0.25pF	GJM0224C1E2R0CB01#	7.4pF				±0.5pF	GJM0222C1E7R4DB01#	
		CJ	2.1pF	±0.25pF	GJM0223C1E2R1CB01#				7.5pF	±0.5pF	GJM0222C1E7R5DB01#
			2.2pF	±0.25pF	GJM0223C1E2R2CB01#				7.6pF	±0.5pF	GJM0222C1E7R6DB01#
			2.3pF	±0.25pF	GJM0223C1E2R3CB01#				7.7pF	±0.5pF	GJM0222C1E7R7DB01#
			2.4pF	±0.25pF	GJM0223C1E2R4CB01#				7.8pF	±0.5pF	GJM0222C1E7R8DB01#
			2.5pF	±0.25pF	GJM0223C1E2R5CB01#				7.9pF	±0.5pF	GJM0222C1E7R9DB01#
			2.6pF	±0.25pF	GJM0223C1E2R6CB01#				8.0pF	±0.5pF	GJM0222C1E8R0DB01#
			2.7pF	±0.25pF	GJM0223C1E2R7CB01#				8.1pF	±0.5pF	GJM0222C1E8R1DB01#
			2.8pF	±0.25pF	GJM0223C1E2R8CB01#				8.2pF	±0.5pF	GJM0222C1E8R2DB01#
			2.9pF	±0.25pF	GJM0223C1E2R9CB01#				8.3pF	±0.5pF	GJM0222C1E8R3DB01#
			3.0pF	±0.25pF	GJM0223C1E3R0CB01#				8.4pF	±0.5pF	GJM0222C1E8R4DB01#
			3.1pF	±0.25pF	GJM0223C1E3R1CB01#				8.5pF	±0.5pF	GJM0222C1E8R5DB01#
			3.2pF	±0.25pF	GJM0223C1E3R2CB01#				8.6pF	±0.5pF	GJM0222C1E8R6DB01#
			3.3pF	±0.25pF	GJM0223C1E3R3CB01#				8.7pF	±0.5pF	GJM0222C1E8R7DB01#
			3.4pF	±0.25pF	GJM0223C1E3R4CB01#				8.8pF	±0.5pF	GJM0222C1E8R8DB01#
			3.5pF	±0.25pF	GJM0223C1E3R5CB01#				8.9pF	±0.5pF	GJM0222C1E8R9DB01#
			3.6pF	±0.25pF	GJM0223C1E3R6CB01#				9.0pF	±0.5pF	GJM0222C1E9R0DB01#
			3.7pF	±0.25pF	GJM0223C1E3R7CB01#				9.1pF	±0.5pF	GJM0222C1E9R1DB01#
			3.8pF	±0.25pF	GJM0223C1E3R8CB01#				9.2pF	±0.5pF	GJM0222C1E9R2DB01#
			3.9pF	±0.25pF	GJM0223C1E3R9CB01#				9.3pF	±0.5pF	GJM0222C1E9R3DB01#
			CH	4.0pF	±0.25pF				GJM0222C1E4R0CB01#	9.4pF	±0.5pF
		4.1pF		±0.25pF	GJM0222C1E4R1CB01#				9.5pF	±0.5pF	GJM0222C1E9R5DB01#
		4.2pF		±0.25pF	GJM0222C1E4R2CB01#				9.6pF	±0.5pF	GJM0222C1E9R6DB01#
		4.3pF		±0.25pF	GJM0222C1E4R3CB01#				9.7pF	±0.5pF	GJM0222C1E9R7DB01#
		4.4pF		±0.25pF	GJM0222C1E4R4CB01#				9.8pF	±0.5pF	GJM0222C1E9R8DB01#
		4.5pF		±0.25pF	GJM0222C1E4R5CB01#				9.9pF	±0.5pF	GJM0222C1E9R9DB01#
		4.6pF		±0.25pF	GJM0222C1E4R6CB01#				10pF	±5%	GJM0222C1E100JB01#
		4.7pF		±0.25pF	GJM0222C1E4R7CB01#				11pF	±5%	GJM0222C1E110JB01#
		4.8pF		±0.25pF	GJM0222C1E4R8CB01#				12pF	±5%	GJM0222C1E120JB01#
		4.9pF		±0.25pF	GJM0222C1E4R9CB01#				13pF	±5%	GJM0222C1E130JB01#
		5.0pF		±0.25pF	GJM0222C1E5R0CB01#				15pF	±5%	GJM0222C1E150JB01#
		5.1pF		±0.5pF	GJM0222C1E5R1DB01#				16pF	±5%	GJM0222C1E160JB01#
		5.2pF		±0.5pF	GJM0222C1E5R2DB01#				18pF	±5%	GJM0222C1E180JB01#
		5.3pF		±0.5pF	GJM0222C1E5R3DB01#				20pF	±5%	GJM0222C1E200JB01#
		5.4pF		±0.5pF	GJM0222C1E5R4DB01#				22pF	±5%	GJM0222C1E220JB01#

Part number # indicates the package specification code.

GRM
 GR3
 GRJ
 GR4
 GJM
 GQM
 GA2
 GA3 GB
 GA3 GD
 GA3 GF
 LLL
 LLA
 LLM
 LLR
 NFM
 KRM
 KR3
 GMA
 GMD
 ⚠Caution /Notice

GJM Series Temperature Compensating Type High Q Part Number List

0.6×0.3mm

T max.	Rated Voltage	TC Code	Cap.	Tol.	Part Number
0.33mm	100Vdc	COG	0.30pF	±0.1pF	GJM0335C2AR30BB01#
			0.40pF	±0.1pF	GJM0335C2AR40BB01#
			0.50pF	±0.1pF	GJM0335C2AR50BB01#
			0.60pF	±0.1pF	GJM0335C2AR60BB01#
			0.70pF	±0.1pF	GJM0335C2AR70BB01#
			0.80pF	±0.1pF	GJM0335C2AR80BB01#
			0.90pF	±0.1pF	GJM0335C2AR90BB01#
			1.0pF	±0.25pF	GJM0335C2A1R0CB01#
			1.1pF	±0.25pF	GJM0335C2A1R1CB01#
			1.2pF	±0.25pF	GJM0335C2A1R2CB01#
			1.3pF	±0.25pF	GJM0335C2A1R3CB01#
			1.4pF	±0.25pF	GJM0335C2A1R4CB01#
			1.5pF	±0.25pF	GJM0335C2A1R5CB01#
			1.6pF	±0.25pF	GJM0335C2A1R6CB01#
			1.7pF	±0.25pF	GJM0335C2A1R7CB01#
			1.8pF	±0.25pF	GJM0335C2A1R8CB01#
			1.9pF	±0.25pF	GJM0335C2A1R9CB01#
			2.0pF	±0.25pF	GJM0335C2A2R0CB01#
			2.1pF	±0.25pF	GJM0335C2A2R1CB01#
			2.2pF	±0.25pF	GJM0335C2A2R2CB01#
			2.3pF	±0.25pF	GJM0335C2A2R3CB01#
			2.4pF	±0.25pF	GJM0335C2A2R4CB01#
			2.5pF	±0.25pF	GJM0335C2A2R5CB01#
			2.6pF	±0.25pF	GJM0335C2A2R6CB01#
			2.7pF	±0.25pF	GJM0335C2A2R7CB01#
			2.8pF	±0.25pF	GJM0335C2A2R8CB01#
			2.9pF	±0.25pF	GJM0335C2A2R9CB01#
			3.0pF	±0.25pF	GJM0335C2A3R0CB01#
			3.1pF	±0.25pF	GJM0335C2A3R1CB01#
			3.2pF	±0.25pF	GJM0335C2A3R2CB01#
			3.3pF	±0.25pF	GJM0335C2A3R3CB01#
			3.4pF	±0.25pF	GJM0335C2A3R4CB01#
			3.5pF	±0.25pF	GJM0335C2A3R5CB01#
			3.6pF	±0.25pF	GJM0335C2A3R6CB01#
			3.7pF	±0.25pF	GJM0335C2A3R7CB01#
			3.8pF	±0.25pF	GJM0335C2A3R8CB01#
			3.9pF	±0.25pF	GJM0335C2A3R9CB01#
			4.0pF	±0.25pF	GJM0335C2A4R0CB01#
			4.1pF	±0.25pF	GJM0335C2A4R1CB01#
			4.2pF	±0.25pF	GJM0335C2A4R2CB01#
			4.3pF	±0.25pF	GJM0335C2A4R3CB01#
			4.4pF	±0.25pF	GJM0335C2A4R4CB01#
			4.5pF	±0.25pF	GJM0335C2A4R5CB01#
			4.6pF	±0.25pF	GJM0335C2A4R6CB01#
			4.7pF	±0.25pF	GJM0335C2A4R7CB01#
			4.8pF	±0.25pF	GJM0335C2A4R8CB01#
			4.9pF	±0.25pF	GJM0335C2A4R9CB01#
			5.0pF	±0.25pF	GJM0335C2A5R0CB01#
			5.1pF	±0.5pF	GJM0335C2A5R1DB01#
			5.2pF	±0.5pF	GJM0335C2A5R2DB01#
			5.3pF	±0.5pF	GJM0335C2A5R3DB01#
			5.4pF	±0.5pF	GJM0335C2A5R4DB01#

T max.	Rated Voltage	TC Code	Cap.	Tol.	Part Number			
0.33mm	100Vdc	COG	5.5pF	±0.5pF	GJM0335C2A5R5DB01#			
			5.6pF	±0.5pF	GJM0335C2A5R6DB01#			
			5.7pF	±0.5pF	GJM0335C2A5R7DB01#			
			5.8pF	±0.5pF	GJM0335C2A5R8DB01#			
			5.9pF	±0.5pF	GJM0335C2A5R9DB01#			
			6.0pF	±0.5pF	GJM0335C2A6R0DB01#			
			6.1pF	±0.5pF	GJM0335C2A6R1DB01#			
			6.2pF	±0.5pF	GJM0335C2A6R2DB01#			
			6.3pF	±0.5pF	GJM0335C2A6R3DB01#			
			6.4pF	±0.5pF	GJM0335C2A6R4DB01#			
			6.5pF	±0.5pF	GJM0335C2A6R5DB01#			
			6.6pF	±0.5pF	GJM0335C2A6R6DB01#			
			6.7pF	±0.5pF	GJM0335C2A6R7DB01#			
			6.8pF	±0.5pF	GJM0335C2A6R8DB01#			
			6.9pF	±0.5pF	GJM0335C2A6R9DB01#			
			7.0pF	±0.5pF	GJM0335C2A7R0DB01#			
			7.1pF	±0.5pF	GJM0335C2A7R1DB01#			
			7.2pF	±0.5pF	GJM0335C2A7R2DB01#			
			7.3pF	±0.5pF	GJM0335C2A7R3DB01#			
			7.4pF	±0.5pF	GJM0335C2A7R4DB01#			
			7.5pF	±0.5pF	GJM0335C2A7R5DB01#			
			7.6pF	±0.5pF	GJM0335C2A7R6DB01#			
			7.7pF	±0.5pF	GJM0335C2A7R7DB01#			
			7.8pF	±0.5pF	GJM0335C2A7R8DB01#			
			7.9pF	±0.5pF	GJM0335C2A7R9DB01#			
			8.0pF	±0.5pF	GJM0335C2A8R0DB01#			
			8.1pF	±0.5pF	GJM0335C2A8R1DB01#			
			8.2pF	±0.5pF	GJM0335C2A8R2DB01#			
			8.3pF	±0.5pF	GJM0335C2A8R3DB01#			
			8.4pF	±0.5pF	GJM0335C2A8R4DB01#			
			8.5pF	±0.5pF	GJM0335C2A8R5DB01#			
			8.6pF	±0.5pF	GJM0335C2A8R6DB01#			
			8.7pF	±0.5pF	GJM0335C2A8R7DB01#			
			8.8pF	±0.5pF	GJM0335C2A8R8DB01#			
			8.9pF	±0.5pF	GJM0335C2A8R9DB01#			
			9.0pF	±0.5pF	GJM0335C2A9R0DB01#			
			9.1pF	±0.5pF	GJM0335C2A9R1DB01#			
			9.2pF	±0.5pF	GJM0335C2A9R2DB01#			
			9.3pF	±0.5pF	GJM0335C2A9R3DB01#			
			9.4pF	±0.5pF	GJM0335C2A9R4DB01#			
			9.5pF	±0.5pF	GJM0335C2A9R5DB01#			
			9.6pF	±0.5pF	GJM0335C2A9R6DB01#			
			9.7pF	±0.5pF	GJM0335C2A9R7DB01#			
			9.8pF	±0.5pF	GJM0335C2A9R8DB01#			
			9.9pF	±0.5pF	GJM0335C2A9R9DB01#			
			10pF	±5%	GJM0335C2A100JB01#			
			11pF	±5%	GJM0335C2A110JB01#			
			12pF	±5%	GJM0335C2A120JB01#			
			13pF	±5%	GJM0335C2A130JB01#			
			15pF	±5%	GJM0335C2A150JB01#			
					CK	0.30pF	±0.1pF	GJM0334C2AR30BB01#
						0.40pF	±0.1pF	GJM0334C2AR40BB01#
						0.50pF	±0.1pF	GJM0334C2AR50BB01#
						0.60pF	±0.1pF	GJM0334C2AR60BB01#

Part number # indicates the package specification code.

GRM
GR3
GRJ
GR4
GJM
GQM
GA2
GA3 GB
GA3 GD
GA3 GF
LLL
LLA
LLM
LLR
NFM
KRM
KR3
GMA
GMD
⚠Caution /Notice

GJM Series Temperature Compensating Type High Q Part Number List

(→ 0.6×0.3mm)

T max.	Rated Voltage	TC Code	Cap.	Tol.	Part Number	T max.	Rated Voltage	TC Code	Cap.	Tol.	Part Number	
0.33mm	100Vdc	CK	0.70pF	±0.1pF	GJM0334C2AR70BB01#	0.33mm	100Vdc	CH	6.1pF	±0.5pF	GJM0332C2A6R1DB01#	
			0.80pF	±0.1pF	GJM0334C2AR80BB01#				6.2pF	±0.5pF	GJM0332C2A6R2DB01#	
			0.90pF	±0.1pF	GJM0334C2AR90BB01#				6.3pF	±0.5pF	GJM0332C2A6R3DB01#	
			1.0pF	±0.25pF	GJM0334C2A1R0CB01#				6.4pF	±0.5pF	GJM0332C2A6R4DB01#	
			1.1pF	±0.25pF	GJM0334C2A1R1CB01#				6.5pF	±0.5pF	GJM0332C2A6R5DB01#	
			1.2pF	±0.25pF	GJM0334C2A1R2CB01#				6.6pF	±0.5pF	GJM0332C2A6R6DB01#	
			1.3pF	±0.25pF	GJM0334C2A1R3CB01#				6.7pF	±0.5pF	GJM0332C2A6R7DB01#	
			1.4pF	±0.25pF	GJM0334C2A1R4CB01#				6.8pF	±0.5pF	GJM0332C2A6R8DB01#	
			1.5pF	±0.25pF	GJM0334C2A1R5CB01#				6.9pF	±0.5pF	GJM0332C2A6R9DB01#	
			1.6pF	±0.25pF	GJM0334C2A1R6CB01#				7.0pF	±0.5pF	GJM0332C2A7R0DB01#	
			1.7pF	±0.25pF	GJM0334C2A1R7CB01#				7.1pF	±0.5pF	GJM0332C2A7R1DB01#	
			1.8pF	±0.25pF	GJM0334C2A1R8CB01#				7.2pF	±0.5pF	GJM0332C2A7R2DB01#	
			1.9pF	±0.25pF	GJM0334C2A1R9CB01#				7.3pF	±0.5pF	GJM0332C2A7R3DB01#	
			2.0pF	±0.25pF	GJM0334C2A2R0CB01#				7.4pF	±0.5pF	GJM0332C2A7R4DB01#	
			CJ	2.1pF	±0.25pF				GJM0333C2A2R1CB01#	7.5pF	±0.5pF	GJM0332C2A7R5DB01#
				2.2pF	±0.25pF				GJM0333C2A2R2CB01#	7.6pF	±0.5pF	GJM0332C2A7R6DB01#
				2.3pF	±0.25pF				GJM0333C2A2R3CB01#	7.7pF	±0.5pF	GJM0332C2A7R7DB01#
				2.4pF	±0.25pF				GJM0333C2A2R4CB01#	7.8pF	±0.5pF	GJM0332C2A7R8DB01#
				2.5pF	±0.25pF				GJM0333C2A2R5CB01#	7.9pF	±0.5pF	GJM0332C2A7R9DB01#
				2.6pF	±0.25pF				GJM0333C2A2R6CB01#	8.0pF	±0.5pF	GJM0332C2A8R0DB01#
		2.7pF		±0.25pF	GJM0333C2A2R7CB01#			8.1pF	±0.5pF	GJM0332C2A8R1DB01#		
		2.8pF		±0.25pF	GJM0333C2A2R8CB01#			8.2pF	±0.5pF	GJM0332C2A8R2DB01#		
		2.9pF		±0.25pF	GJM0333C2A2R9CB01#			8.3pF	±0.5pF	GJM0332C2A8R3DB01#		
		3.0pF		±0.25pF	GJM0333C2A3R0CB01#			8.4pF	±0.5pF	GJM0332C2A8R4DB01#		
		3.1pF		±0.25pF	GJM0333C2A3R1CB01#			8.5pF	±0.5pF	GJM0332C2A8R5DB01#		
		3.2pF		±0.25pF	GJM0333C2A3R2CB01#			8.6pF	±0.5pF	GJM0332C2A8R6DB01#		
		3.3pF		±0.25pF	GJM0333C2A3R3CB01#			8.7pF	±0.5pF	GJM0332C2A8R7DB01#		
		3.4pF		±0.25pF	GJM0333C2A3R4CB01#			8.8pF	±0.5pF	GJM0332C2A8R8DB01#		
		3.5pF		±0.25pF	GJM0333C2A3R5CB01#			8.9pF	±0.5pF	GJM0332C2A8R9DB01#		
		3.6pF		±0.25pF	GJM0333C2A3R6CB01#			9.0pF	±0.5pF	GJM0332C2A9R0DB01#		
		3.7pF		±0.25pF	GJM0333C2A3R7CB01#			9.1pF	±0.5pF	GJM0332C2A9R1DB01#		
		3.8pF		±0.25pF	GJM0333C2A3R8CB01#			9.2pF	±0.5pF	GJM0332C2A9R2DB01#		
		3.9pF		±0.25pF	GJM0333C2A3R9CB01#			9.3pF	±0.5pF	GJM0332C2A9R3DB01#		
		CH		4.0pF	±0.25pF			GJM0332C2A4R0CB01#	9.4pF	±0.5pF	GJM0332C2A9R4DB01#	
			4.1pF	±0.25pF	GJM0332C2A4R1CB01#			9.5pF	±0.5pF	GJM0332C2A9R5DB01#		
			4.2pF	±0.25pF	GJM0332C2A4R2CB01#			9.6pF	±0.5pF	GJM0332C2A9R6DB01#		
			4.3pF	±0.25pF	GJM0332C2A4R3CB01#			9.7pF	±0.5pF	GJM0332C2A9R7DB01#		
			4.4pF	±0.25pF	GJM0332C2A4R4CB01#			9.8pF	±0.5pF	GJM0332C2A9R8DB01#		
			4.5pF	±0.25pF	GJM0332C2A4R5CB01#			9.9pF	±0.5pF	GJM0332C2A9R9DB01#		
			4.6pF	±0.25pF	GJM0332C2A4R6CB01#			10pF	±5%	GJM0332C2A100JB01#		
			4.7pF	±0.25pF	GJM0332C2A4R7CB01#			11pF	±5%	GJM0332C2A110JB01#		
			4.8pF	±0.25pF	GJM0332C2A4R8CB01#			12pF	±5%	GJM0332C2A120JB01#		
			4.9pF	±0.25pF	GJM0332C2A4R9CB01#			13pF	±5%	GJM0332C2A130JB01#		
			5.0pF	±0.25pF	GJM0332C2A5R0CB01#			15pF	±5%	GJM0332C2A150JB01#		
			5.1pF	±0.5pF	GJM0332C2A5R1DB01#			X8G	0.30pF	±0.1pF	GJM0335G2AR30BB01#	
			5.2pF	±0.5pF	GJM0332C2A5R2DB01#				0.40pF	±0.1pF	GJM0335G2AR40BB01#	
			5.3pF	±0.5pF	GJM0332C2A5R3DB01#				0.50pF	±0.1pF	GJM0335G2AR50BB01#	
			5.4pF	±0.5pF	GJM0332C2A5R4DB01#				0.60pF	±0.1pF	GJM0335G2AR60BB01#	
			5.5pF	±0.5pF	GJM0332C2A5R5DB01#				0.70pF	±0.1pF	GJM0335G2AR70BB01#	
			5.6pF	±0.5pF	GJM0332C2A5R6DB01#				0.80pF	±0.1pF	GJM0335G2AR80BB01#	
			5.7pF	±0.5pF	GJM0332C2A5R7DB01#				0.90pF	±0.1pF	GJM0335G2AR90BB01#	
			5.8pF	±0.5pF	GJM0332C2A5R8DB01#				1.0pF	±0.25pF	GJM0335G2A1R0CB01#	
			5.9pF	±0.5pF	GJM0332C2A5R9DB01#				1.1pF	±0.25pF	GJM0335G2A1R1CB01#	
		6.0pF	±0.5pF	GJM0332C2A6R0DB01#	1.2pF				±0.25pF	GJM0335G2A1R2CB01#		

Part number # indicates the package specification code.

GRM
 GR3
 GRJ
 GR4
 GJM
 GQM
 GA2
 GA3 GB
 GA3 GD
 GA3 GF
 LLL
 LLA
 LLM
 LLR
 NFM
 KRM
 KR3
 GMA
 GMD
 ⚠Caution /Notice

GJM Series Temperature Compensating Type High Q Part Number List

(→ 0.6×0.3mm)

T max.	Rated Voltage	TC Code	Cap.	Tol.	Part Number		T max.	Rated Voltage	TC Code	Cap.	Tol.	Part Number			
0.33mm	100Vdc	X8G	1.3pF	±0.25pF	GJM0335G2A1R3CB01#		0.33mm	25Vdc	COG	2.6pF	±0.25pF	GJM0335C1E2R6CB01#			
			1.5pF	±0.25pF	GJM0335G2A1R5CB01#					2.7pF	±0.25pF	GJM0335C1E2R7CB01#			
			1.6pF	±0.25pF	GJM0335G2A1R6CB01#					2.8pF	±0.25pF	GJM0335C1E2R8CB01#			
			1.8pF	±0.25pF	GJM0335G2A1R8CB01#					2.9pF	±0.25pF	GJM0335C1E2R9CB01#			
			2.0pF	±0.25pF	GJM0335G2A2R0CB01#					3.0pF	±0.25pF	GJM0335C1E3R0CB01#			
			2.2pF	±0.25pF	GJM0335G2A2R2CB01#					3.1pF	±0.25pF	GJM0335C1E3R1CB01#			
			2.4pF	±0.25pF	GJM0335G2A2R4CB01#					3.2pF	±0.25pF	GJM0335C1E3R2CB01#			
			2.7pF	±0.25pF	GJM0335G2A2R7CB01#					3.3pF	±0.25pF	GJM0335C1E3R3CB01#			
			3.0pF	±0.25pF	GJM0335G2A3R0CB01#					3.4pF	±0.25pF	GJM0335C1E3R4CB01#			
			3.3pF	±0.25pF	GJM0335G2A3R3CB01#					3.5pF	±0.25pF	GJM0335C1E3R5CB01#			
			3.6pF	±0.25pF	GJM0335G2A3R6CB01#					3.6pF	±0.25pF	GJM0335C1E3R6CB01#			
			3.9pF	±0.25pF	GJM0335G2A3R9CB01#					3.7pF	±0.25pF	GJM0335C1E3R7CB01#			
			4.3pF	±0.25pF	GJM0335G2A4R3CB01#					3.8pF	±0.25pF	GJM0335C1E3R8CB01#			
			4.7pF	±0.25pF	GJM0335G2A4R7CB01#					3.9pF	±0.25pF	GJM0335C1E3R9CB01#			
			5.1pF	±0.5pF	GJM0335G2A5R1DB01#					4.0pF	±0.25pF	GJM0335C1E4R0CB01#			
			5.6pF	±0.5pF	GJM0335G2A5R6DB01#					4.1pF	±0.25pF	GJM0335C1E4R1CB01#			
			6.2pF	±0.5pF	GJM0335G2A6R2DB01#					4.2pF	±0.25pF	GJM0335C1E4R2CB01#			
			6.8pF	±0.5pF	GJM0335G2A6R8DB01#					4.3pF	±0.25pF	GJM0335C1E4R3CB01#			
			7.5pF	±0.5pF	GJM0335G2A7R5DB01#					4.4pF	±0.25pF	GJM0335C1E4R4CB01#			
			8.2pF	±0.5pF	GJM0335G2A8R2DB01#					4.5pF	±0.25pF	GJM0335C1E4R5CB01#			
	9.1pF	±0.5pF	GJM0335G2A9R1DB01#		4.6pF	±0.25pF				GJM0335C1E4R6CB01#					
	10pF	±5%	GJM0335G2A100JB01#	D1	4.7pF	±0.25pF				GJM0335C1E4R7CB01#					
	12pF	±5%	GJM0335G2A120JB01#	D1	4.8pF	±0.25pF				GJM0335C1E4R8CB01#					
	15pF	±5%	GJM0335G2A150JB01#	D1	4.9pF	±0.25pF				GJM0335C1E4R9CB01#					
		50Vdc	COG	0.20pF	±0.1pF	GJM0335C1HR20BB01#				D1	5.0pF	±0.25pF	GJM0335C1E5R0CB01#		
					0.30pF	±0.1pF				GJM0335C1HR30BB01#	D1	5.1pF	±0.5pF	GJM0335C1E5R1DB01#	
					0.40pF	±0.1pF				GJM0335C1HR40BB01#	D1	5.2pF	±0.5pF	GJM0335C1E5R2DB01#	
					0.50pF	±0.1pF				GJM0335C1HR50BB01#	D1	5.3pF	±0.5pF	GJM0335C1E5R3DB01#	
					0.60pF	±0.1pF				GJM0335C1HR60BB01#	D1	5.4pF	±0.5pF	GJM0335C1E5R4DB01#	
					0.70pF	±0.1pF				GJM0335C1HR70BB01#	D1	5.5pF	±0.5pF	GJM0335C1E5R5DB01#	
					0.80pF	±0.1pF				GJM0335C1HR80BB01#	D1	5.6pF	±0.5pF	GJM0335C1E5R6DB01#	
					0.90pF	±0.1pF				GJM0335C1HR90BB01#	D1	5.7pF	±0.5pF	GJM0335C1E5R7DB01#	
					7.5pF	±0.5pF				GJM0335C1H7R5DB01#		5.8pF	±0.5pF	GJM0335C1E5R8DB01#	
					8.2pF	±0.5pF				GJM0335C1H8R2DB01#		5.9pF	±0.5pF	GJM0335C1E5R9DB01#	
					9.1pF	±0.5pF				GJM0335C1H9R1DB01#		6.0pF	±0.5pF	GJM0335C1E6R0DB01#	
					10pF	±5%				GJM0335C1H100JB01#		6.1pF	±0.5pF	GJM0335C1E6R1DB01#	
					12pF	±5%				GJM0335C1H120JB01#		6.2pF	±0.5pF	GJM0335C1E6R2DB01#	
					15pF	±5%				GJM0335C1H150JB01#		6.3pF	±0.5pF	GJM0335C1E6R3DB01#	
				25Vdc	COG	1.0pF				±0.25pF	GJM0335C1E1R0CB01#		6.4pF	±0.5pF	GJM0335C1E6R4DB01#
			1.1pF			±0.25pF				GJM0335C1E1R1CB01#		6.5pF	±0.5pF	GJM0335C1E6R5DB01#	
			1.2pF			±0.25pF				GJM0335C1E1R2CB01#		6.6pF	±0.5pF	GJM0335C1E6R6DB01#	
			1.3pF			±0.25pF				GJM0335C1E1R3CB01#		6.7pF	±0.5pF	GJM0335C1E6R7DB01#	
			1.4pF			±0.25pF				GJM0335C1E1R4CB01#		6.8pF	±0.5pF	GJM0335C1E6R8DB01#	
			1.5pF			±0.25pF				GJM0335C1E1R5CB01#		6.9pF	±0.5pF	GJM0335C1E6R9DB01#	
			1.6pF			±0.25pF				GJM0335C1E1R6CB01#		7.0pF	±0.5pF	GJM0335C1E7R0DB01#	
		1.7pF	±0.25pF			GJM0335C1E1R7CB01#		7.1pF	±0.5pF	GJM0335C1E7R1DB01#					
		1.8pF	±0.25pF			GJM0335C1E1R8CB01#		7.2pF	±0.5pF	GJM0335C1E7R2DB01#					
		1.9pF	±0.25pF			GJM0335C1E1R9CB01#		7.3pF	±0.5pF	GJM0335C1E7R3DB01#					
		2.0pF	±0.25pF			GJM0335C1E2R0CB01#		7.4pF	±0.5pF	GJM0335C1E7R4DB01#					
		2.1pF	±0.25pF			GJM0335C1E2R1CB01#		7.5pF	±0.5pF	GJM0335C1E7R5DB01#					
		2.2pF	±0.25pF			GJM0335C1E2R2CB01#		7.6pF	±0.5pF	GJM0335C1E7R6DB01#					
		2.3pF	±0.25pF			GJM0335C1E2R3CB01#		7.7pF	±0.5pF	GJM0335C1E7R7DB01#					
		2.4pF	±0.25pF			GJM0335C1E2R4CB01#		7.8pF	±0.5pF	GJM0335C1E7R8DB01#					
		2.5pF	±0.25pF	GJM0335C1E2R5CB01#		7.9pF	±0.5pF	GJM0335C1E7R9DB01#							

- GRM
- GR3
- GRJ
- GR4
- GJM
- GQM
- GA2
- GA3 GB
- GA3 GD
- GA3 GF
- LLL
- LLA
- LLM
- LLR
- NFM
- KRM
- KR3
- GMA
- GMD
- ⚠Caution /Notice

Part number # indicates the package specification code.

GJM Series Temperature Compensating Type High Q Part Number List

(→ 0.6×0.3mm)

T max.	Rated Voltage	TC Code	Cap.	Tol.	Part Number	T max.	Rated Voltage	TC Code	Cap.	Tol.	Part Number	
0.33mm	25Vdc	COG	8.0pF	±0.5pF	GJM0335C1E8R0DB01#	0.33mm	25Vdc	CJ	3.1pF	±0.25pF	GJM0333C1E3R1CB01#	
			8.1pF	±0.5pF	GJM0335C1E8R1DB01#				3.2pF	±0.25pF	GJM0333C1E3R2CB01#	
			8.2pF	±0.5pF	GJM0335C1E8R2DB01#				3.3pF	±0.25pF	GJM0333C1E3R3CB01#	
			8.3pF	±0.5pF	GJM0335C1E8R3DB01#				3.4pF	±0.25pF	GJM0333C1E3R4CB01#	
			8.4pF	±0.5pF	GJM0335C1E8R4DB01#				3.5pF	±0.25pF	GJM0333C1E3R5CB01#	
			8.5pF	±0.5pF	GJM0335C1E8R5DB01#				3.6pF	±0.25pF	GJM0333C1E3R6CB01#	
			8.6pF	±0.5pF	GJM0335C1E8R6DB01#				3.7pF	±0.25pF	GJM0333C1E3R7CB01#	
			8.7pF	±0.5pF	GJM0335C1E8R7DB01#				3.8pF	±0.25pF	GJM0333C1E3R8CB01#	
			8.8pF	±0.5pF	GJM0335C1E8R8DB01#				3.9pF	±0.25pF	GJM0333C1E3R9CB01#	
			8.9pF	±0.5pF	GJM0335C1E8R9DB01#				CH	4.0pF	±0.25pF	GJM0332C1E4R0CB01#
			9.0pF	±0.5pF	GJM0335C1E9R0DB01#					4.1pF	±0.25pF	GJM0332C1E4R1CB01#
			9.1pF	±0.5pF	GJM0335C1E9R1DB01#					4.2pF	±0.25pF	GJM0332C1E4R2CB01#
			9.2pF	±0.5pF	GJM0335C1E9R2DB01#					4.3pF	±0.25pF	GJM0332C1E4R3CB01#
			9.3pF	±0.5pF	GJM0335C1E9R3DB01#					4.4pF	±0.25pF	GJM0332C1E4R4CB01#
			9.4pF	±0.5pF	GJM0335C1E9R4DB01#					4.5pF	±0.25pF	GJM0332C1E4R5CB01#
			9.5pF	±0.5pF	GJM0335C1E9R5DB01#					4.6pF	±0.25pF	GJM0332C1E4R6CB01#
			9.6pF	±0.5pF	GJM0335C1E9R6DB01#			4.7pF		±0.25pF	GJM0332C1E4R7CB01#	
			9.7pF	±0.5pF	GJM0335C1E9R7DB01#			4.8pF		±0.25pF	GJM0332C1E4R8CB01#	
			9.8pF	±0.5pF	GJM0335C1E9R8DB01#			4.9pF		±0.25pF	GJM0332C1E4R9CB01#	
			9.9pF	±0.5pF	GJM0335C1E9R9DB01#			5.0pF		±0.25pF	GJM0332C1E5R0CB01#	
			10pF	±5%	GJM0335C1E100JB01#			5.1pF		±0.5pF	GJM0332C1E5R1DB01#	
			11pF	±5%	GJM0335C1E110JB01#			5.2pF		±0.5pF	GJM0332C1E5R2DB01#	
			12pF	±5%	GJM0335C1E120JB01#			5.3pF		±0.5pF	GJM0332C1E5R3DB01#	
			13pF	±5%	GJM0335C1E130JB01#			5.4pF	±0.5pF	GJM0332C1E5R4DB01#		
			15pF	±5%	GJM0335C1E150JB01#			5.5pF	±0.5pF	GJM0332C1E5R5DB01#		
			16pF	±5%	GJM0335C1E160JB01#			5.6pF	±0.5pF	GJM0332C1E5R6DB01#		
			18pF	±5%	GJM0335C1E180JB01#			5.7pF	±0.5pF	GJM0332C1E5R7DB01#		
			20pF	±5%	GJM0335C1E200JB01#			5.8pF	±0.5pF	GJM0332C1E5R8DB01#		
			22pF	±5%	GJM0335C1E220JB01#			5.9pF	±0.5pF	GJM0332C1E5R9DB01#		
			24pF	±5%	GJM0335C1E240JB01#			6.0pF	±0.5pF	GJM0332C1E6R0DB01#		
			27pF	±5%	GJM0335C1E270JB01#			6.1pF	±0.5pF	GJM0332C1E6R1DB01#		
			30pF	±5%	GJM0335C1E300JB01#			6.2pF	±0.5pF	GJM0332C1E6R2DB01#		
			33pF	±5%	GJM0335C1E330JB01#			6.3pF	±0.5pF	GJM0332C1E6R3DB01#		
		CK	1.0pF	±0.25pF	GJM0334C1E1R0CB01#			6.4pF	±0.5pF	GJM0332C1E6R4DB01#		
			1.1pF	±0.25pF	GJM0334C1E1R1CB01#			6.5pF	±0.5pF	GJM0332C1E6R5DB01#		
			1.2pF	±0.25pF	GJM0334C1E1R2CB01#			6.6pF	±0.5pF	GJM0332C1E6R6DB01#		
			1.3pF	±0.25pF	GJM0334C1E1R3CB01#			6.7pF	±0.5pF	GJM0332C1E6R7DB01#		
			1.4pF	±0.25pF	GJM0334C1E1R4CB01#			6.8pF	±0.5pF	GJM0332C1E6R8DB01#		
			1.5pF	±0.25pF	GJM0334C1E1R5CB01#			6.9pF	±0.5pF	GJM0332C1E6R9DB01#		
			1.6pF	±0.25pF	GJM0334C1E1R6CB01#			7.0pF	±0.5pF	GJM0332C1E7R0DB01#		
			1.7pF	±0.25pF	GJM0334C1E1R7CB01#			7.1pF	±0.5pF	GJM0332C1E7R1DB01#		
			1.8pF	±0.25pF	GJM0334C1E1R8CB01#			7.2pF	±0.5pF	GJM0332C1E7R2DB01#		
			1.9pF	±0.25pF	GJM0334C1E1R9CB01#			7.3pF	±0.5pF	GJM0332C1E7R3DB01#		
			2.0pF	±0.25pF	GJM0334C1E2R0CB01#			7.4pF	±0.5pF	GJM0332C1E7R4DB01#		
			CJ	2.1pF	±0.25pF			GJM0333C1E2R1CB01#	7.5pF	±0.5pF	GJM0332C1E7R5DB01#	
				2.2pF	±0.25pF			GJM0333C1E2R2CB01#	7.6pF	±0.5pF	GJM0332C1E7R6DB01#	
				2.3pF	±0.25pF			GJM0333C1E2R3CB01#	7.7pF	±0.5pF	GJM0332C1E7R7DB01#	
				2.4pF	±0.25pF			GJM0333C1E2R4CB01#	7.8pF	±0.5pF	GJM0332C1E7R8DB01#	
				2.5pF	±0.25pF			GJM0333C1E2R5CB01#	7.9pF	±0.5pF	GJM0332C1E7R9DB01#	
				2.6pF	±0.25pF			GJM0333C1E2R6CB01#	8.0pF	±0.5pF	GJM0332C1E8R0DB01#	
2.7pF	±0.25pF	GJM0333C1E2R7CB01#		8.1pF	±0.5pF	GJM0332C1E8R1DB01#						
2.8pF	±0.25pF	GJM0333C1E2R8CB01#		8.2pF	±0.5pF	GJM0332C1E8R2DB01#						
2.9pF	±0.25pF	GJM0333C1E2R9CB01#		8.3pF	±0.5pF	GJM0332C1E8R3DB01#						
3.0pF	±0.25pF	GJM0333C1E3R0CB01#		8.4pF	±0.5pF	GJM0332C1E8R4DB01#						

Part number # indicates the package specification code.

GRM
 GR3
 GRJ
 GR4
 GJM
 GQM
 GA2
 GA3 GB
 GA3 GD
 GA3 GF
 LLL
 LLA
 LLM
 LLR
 NFM
 KRM
 KR3
 GMA
 GMD
 ⚠Caution /Notice

GJM Series Temperature Compensating Type High Q Part Number List

(→ 0.6×0.3mm)

T max.	Rated Voltage	TC Code	Cap.	Tol.	Part Number
0.33mm	25Vdc	CH	8.5pF	±0.5pF	GJM0332C1E8R5DB01#
			8.6pF	±0.5pF	GJM0332C1E8R6DB01#
			8.7pF	±0.5pF	GJM0332C1E8R7DB01#
			8.8pF	±0.5pF	GJM0332C1E8R8DB01#
			8.9pF	±0.5pF	GJM0332C1E8R9DB01#
			9.0pF	±0.5pF	GJM0332C1E9R0DB01#
			9.1pF	±0.5pF	GJM0332C1E9R1DB01#
			9.2pF	±0.5pF	GJM0332C1E9R2DB01#
			9.3pF	±0.5pF	GJM0332C1E9R3DB01#
			9.4pF	±0.5pF	GJM0332C1E9R4DB01#
			9.5pF	±0.5pF	GJM0332C1E9R5DB01#
			9.6pF	±0.5pF	GJM0332C1E9R6DB01#
			9.7pF	±0.5pF	GJM0332C1E9R7DB01#
			9.8pF	±0.5pF	GJM0332C1E9R8DB01#
			9.9pF	±0.5pF	GJM0332C1E9R9DB01#
			10pF	±5%	GJM0332C1E100JB01#
			11pF	±5%	GJM0332C1E110JB01#
			12pF	±5%	GJM0332C1E120JB01#
			13pF	±5%	GJM0332C1E130JB01#
			15pF	±5%	GJM0332C1E150JB01#
			16pF	±5%	GJM0332C1E160JB01#
			18pF	±5%	GJM0332C1E180JB01#
			20pF	±5%	GJM0332C1E200JB01#
			22pF	±5%	GJM0332C1E220JB01#
			24pF	±5%	GJM0332C1E240JB01#
			27pF	±5%	GJM0332C1E270JB01#
			30pF	±5%	GJM0332C1E300JB01#
			33pF	±5%	GJM0332C1E330JB01#

1.0×0.5mm

T max.	Rated Voltage	TC Code	Cap.	Tol.	Part Number
0.55mm	50Vdc	COG	0.10pF	±0.05pF	GJM1555C1HR10WB01#
				±0.1pF	GJM1555C1HR10BB01#
			0.20pF	±0.05pF	GJM1555C1HR20WB01#
				±0.1pF	GJM1555C1HR20BB01#
			0.30pF	±0.05pF	GJM1555C1HR30WB01#
				±0.1pF	GJM1555C1HR30BB01#
			0.40pF	±0.05pF	GJM1555C1HR40WB01#
				±0.1pF	GJM1555C1HR40BB01#
			0.50pF	±0.05pF	GJM1555C1HR50WB01#
				±0.1pF	GJM1555C1HR50BB01#
			0.60pF	±0.05pF	GJM1555C1HR60WB01#
				±0.1pF	GJM1555C1HR60BB01#
			0.70pF	±0.05pF	GJM1555C1HR70WB01#
				±0.1pF	GJM1555C1HR70BB01#
			0.80pF	±0.05pF	GJM1555C1HR80WB01#
				±0.1pF	GJM1555C1HR80BB01#
			0.90pF	±0.05pF	GJM1555C1HR90WB01#
				±0.1pF	GJM1555C1HR90BB01#
			1.0pF	±0.05pF	GJM1555C1H1R0WB01#
				±0.1pF	GJM1555C1H1R0BB01#
				±0.25pF	GJM1555C1H1R0CB01#

T max.	Rated Voltage	TC Code	Cap.	Tol.	Part Number
0.55mm	50Vdc	COG	1.1pF	±0.05pF	GJM1555C1H1R1WB01#
				±0.1pF	GJM1555C1H1R1BB01#
				±0.25pF	GJM1555C1H1R1CB01#
			1.2pF	±0.05pF	GJM1555C1H1R2WB01#
				±0.1pF	GJM1555C1H1R2BB01#
				±0.25pF	GJM1555C1H1R2CB01#
			1.3pF	±0.05pF	GJM1555C1H1R3WB01#
				±0.1pF	GJM1555C1H1R3BB01#
				±0.25pF	GJM1555C1H1R3CB01#
			1.4pF	±0.05pF	GJM1555C1H1R4WB01#
				±0.1pF	GJM1555C1H1R4BB01#
				±0.25pF	GJM1555C1H1R4CB01#
			1.5pF	±0.05pF	GJM1555C1H1R5WB01#
				±0.1pF	GJM1555C1H1R5BB01#
				±0.25pF	GJM1555C1H1R5CB01#
			1.6pF	±0.05pF	GJM1555C1H1R6WB01#
				±0.1pF	GJM1555C1H1R6BB01#
				±0.25pF	GJM1555C1H1R6CB01#
			1.7pF	±0.05pF	GJM1555C1H1R7WB01#
				±0.1pF	GJM1555C1H1R7BB01#
				±0.25pF	GJM1555C1H1R7CB01#
			1.8pF	±0.05pF	GJM1555C1H1R8WB01#
				±0.1pF	GJM1555C1H1R8BB01#
				±0.25pF	GJM1555C1H1R8CB01#
			1.9pF	±0.05pF	GJM1555C1H1R9WB01#
				±0.1pF	GJM1555C1H1R9BB01#
				±0.25pF	GJM1555C1H1R9CB01#
			2.0pF	±0.05pF	GJM1555C1H2R0WB01#
				±0.1pF	GJM1555C1H2R0BB01#
				±0.25pF	GJM1555C1H2R0CB01#
			2.1pF	±0.05pF	GJM1555C1H2R1WB01#
				±0.1pF	GJM1555C1H2R1BB01#
				±0.25pF	GJM1555C1H2R1CB01#
			2.2pF	±0.05pF	GJM1555C1H2R2WB01#
				±0.1pF	GJM1555C1H2R2BB01#
				±0.25pF	GJM1555C1H2R2CB01#
			2.3pF	±0.05pF	GJM1555C1H2R3WB01#
				±0.1pF	GJM1555C1H2R3BB01#
				±0.25pF	GJM1555C1H2R3CB01#
			2.4pF	±0.05pF	GJM1555C1H2R4WB01#
				±0.1pF	GJM1555C1H2R4BB01#
				±0.25pF	GJM1555C1H2R4CB01#
			2.5pF	±0.05pF	GJM1555C1H2R5WB01#
				±0.1pF	GJM1555C1H2R5BB01#
				±0.25pF	GJM1555C1H2R5CB01#
			2.6pF	±0.05pF	GJM1555C1H2R6WB01#
				±0.1pF	GJM1555C1H2R6BB01#
				±0.25pF	GJM1555C1H2R6CB01#
			2.7pF	±0.05pF	GJM1555C1H2R7WB01#
				±0.1pF	GJM1555C1H2R7BB01#
				±0.25pF	GJM1555C1H2R7CB01#
			2.8pF	±0.05pF	GJM1555C1H2R8WB01#
				±0.1pF	GJM1555C1H2R8BB01#
				±0.25pF	GJM1555C1H2R8CB01#

Part number # indicates the package specification code.

GRM
 GR3
 GRJ
 GR4
 GJM
 GQM
 GA2
 GA3 GB
 GA3 GD
 GA3 GF
 LLL
 LLA
 LLM
 LLR
 NFM
 KRM
 KR3
 GMA
 GMD
 ⚠Caution /Notice

GJM Series Temperature Compensating Type High Q Part Number List

(→ 1.0×0.5mm)

T max.	Rated Voltage	TC Code	Cap.	Tol.	Part Number	T max.	Rated Voltage	TC Code	Cap.	Tol.	Part Number
0.55mm	50Vdc	COG	2.9pF	±0.05pF	GJM1555C1H2R9WB01#	0.55mm	50Vdc	COG	4.7pF	±0.05pF	GJM1555C1H4R7WB01#
				±0.1pF	GJM1555C1H2R9BB01#					±0.1pF	GJM1555C1H4R7BB01#
				±0.25pF	GJM1555C1H2R9CB01#					±0.25pF	GJM1555C1H4R7CB01#
			3.0pF	±0.05pF	GJM1555C1H3R0WB01#				4.8pF	±0.05pF	GJM1555C1H4R8WB01#
				±0.1pF	GJM1555C1H3R0BB01#					±0.1pF	GJM1555C1H4R8BB01#
				±0.25pF	GJM1555C1H3R0CB01#					±0.25pF	GJM1555C1H4R8CB01#
			3.1pF	±0.05pF	GJM1555C1H3R1WB01#				4.9pF	±0.05pF	GJM1555C1H4R9WB01#
				±0.1pF	GJM1555C1H3R1BB01#					±0.1pF	GJM1555C1H4R9BB01#
				±0.25pF	GJM1555C1H3R1CB01#					±0.25pF	GJM1555C1H4R9CB01#
			3.2pF	±0.05pF	GJM1555C1H3R2WB01#				5.0pF	±0.05pF	GJM1555C1H5R0WB01#
				±0.1pF	GJM1555C1H3R2BB01#					±0.1pF	GJM1555C1H5R0BB01#
				±0.25pF	GJM1555C1H3R2CB01#					±0.25pF	GJM1555C1H5R0CB01#
			3.3pF	±0.05pF	GJM1555C1H3R3WB01#				5.1pF	±0.05pF	GJM1555C1H5R1WB01#
				±0.1pF	GJM1555C1H3R3BB01#					±0.1pF	GJM1555C1H5R1BB01#
				±0.25pF	GJM1555C1H3R3CB01#					±0.25pF	GJM1555C1H5R1CB01#
			3.4pF	±0.05pF	GJM1555C1H3R4WB01#				5.2pF	±0.05pF	GJM1555C1H5R2WB01#
				±0.1pF	GJM1555C1H3R4BB01#					±0.1pF	GJM1555C1H5R2BB01#
				±0.25pF	GJM1555C1H3R4CB01#					±0.25pF	GJM1555C1H5R2CB01#
			3.5pF	±0.05pF	GJM1555C1H3R5WB01#				5.3pF	±0.05pF	GJM1555C1H5R3WB01#
				±0.1pF	GJM1555C1H3R5BB01#					±0.1pF	GJM1555C1H5R3BB01#
				±0.25pF	GJM1555C1H3R5CB01#					±0.25pF	GJM1555C1H5R3CB01#
			3.6pF	±0.05pF	GJM1555C1H3R6WB01#				5.4pF	±0.05pF	GJM1555C1H5R4WB01#
				±0.1pF	GJM1555C1H3R6BB01#					±0.1pF	GJM1555C1H5R4BB01#
				±0.25pF	GJM1555C1H3R6CB01#					±0.25pF	GJM1555C1H5R4CB01#
			3.7pF	±0.05pF	GJM1555C1H3R7WB01#				5.5pF	±0.05pF	GJM1555C1H5R5WB01#
				±0.1pF	GJM1555C1H3R7BB01#					±0.1pF	GJM1555C1H5R5BB01#
				±0.25pF	GJM1555C1H3R7CB01#					±0.25pF	GJM1555C1H5R5CB01#
			3.8pF	±0.05pF	GJM1555C1H3R8WB01#				5.6pF	±0.05pF	GJM1555C1H5R6WB01#
				±0.1pF	GJM1555C1H3R8BB01#					±0.1pF	GJM1555C1H5R6BB01#
				±0.25pF	GJM1555C1H3R8CB01#					±0.25pF	GJM1555C1H5R6CB01#
			3.9pF	±0.05pF	GJM1555C1H3R9WB01#				5.7pF	±0.05pF	GJM1555C1H5R7WB01#
				±0.1pF	GJM1555C1H3R9BB01#					±0.1pF	GJM1555C1H5R7BB01#
				±0.25pF	GJM1555C1H3R9CB01#					±0.25pF	GJM1555C1H5R7CB01#
			4.0pF	±0.05pF	GJM1555C1H4R0WB01#				5.8pF	±0.05pF	GJM1555C1H5R8WB01#
				±0.1pF	GJM1555C1H4R0BB01#					±0.1pF	GJM1555C1H5R8BB01#
				±0.25pF	GJM1555C1H4R0CB01#					±0.25pF	GJM1555C1H5R8CB01#
			4.1pF	±0.05pF	GJM1555C1H4R1WB01#				5.9pF	±0.05pF	GJM1555C1H5R9WB01#
				±0.1pF	GJM1555C1H4R1BB01#					±0.1pF	GJM1555C1H5R9BB01#
				±0.25pF	GJM1555C1H4R1CB01#					±0.25pF	GJM1555C1H5R9CB01#
			4.2pF	±0.05pF	GJM1555C1H4R2WB01#				6.0pF	±0.05pF	GJM1555C1H6R0WB01#
				±0.1pF	GJM1555C1H4R2BB01#					±0.1pF	GJM1555C1H6R0BB01#
				±0.25pF	GJM1555C1H4R2CB01#					±0.25pF	GJM1555C1H6R0CB01#
			4.3pF	±0.05pF	GJM1555C1H4R3WB01#				6.1pF	±0.05pF	GJM1555C1H6R1WB01#
				±0.1pF	GJM1555C1H4R3BB01#					±0.1pF	GJM1555C1H6R1BB01#
				±0.25pF	GJM1555C1H4R3CB01#					±0.25pF	GJM1555C1H6R1CB01#
			4.4pF	±0.05pF	GJM1555C1H4R4WB01#						
				±0.1pF	GJM1555C1H4R4BB01#						
				±0.25pF	GJM1555C1H4R4CB01#						
			4.5pF	±0.05pF	GJM1555C1H4R5WB01#						
				±0.1pF	GJM1555C1H4R5BB01#						
				±0.25pF	GJM1555C1H4R5CB01#						
			4.6pF	±0.05pF	GJM1555C1H4R6WB01#						
				±0.1pF	GJM1555C1H4R6BB01#						
				±0.25pF	GJM1555C1H4R6CB01#						

GRM
 GR3
 GRJ
 GR4
GJM
 GQM
 GA2
 GA3 GB
 GA3 GD
 GA3 GF
 LLL
 LLA
 LLM
 LLR
 NFM
 KRM
 KR3
 GMA
 GMD
 ⚠Caution /Notice

Part number # indicates the package specification code.

GJM Series Temperature Compensating Type High Q Part Number List

(→ 1.0×0.5mm)

T max.	Rated Voltage	TC Code	Cap.	Tol.	Part Number	T max.	Rated Voltage	TC Code	Cap.	Tol.	Part Number
0.55mm	50Vdc	COG	6.1pF	±0.25pF	GJM1555C1H6R1CB01#	0.55mm	50Vdc	COG	7.5pF	±0.05pF	GJM1555C1H7R5WB01#
				±0.5pF	GJM1555C1H6R1DB01#					±0.1pF	GJM1555C1H7R5BB01#
			6.2pF	±0.05pF	GJM1555C1H6R2WB01#	±0.25pF			GJM1555C1H7R5CB01#		
				±0.1pF	GJM1555C1H6R2BB01#	±0.5pF			GJM1555C1H7R5DB01#		
				±0.25pF	GJM1555C1H6R2CB01#	7.6pF			±0.05pF	GJM1555C1H7R6WB01#	
				±0.5pF	GJM1555C1H6R2DB01#				±0.1pF	GJM1555C1H7R6BB01#	
			6.3pF	±0.05pF	GJM1555C1H6R3WB01#				±0.25pF	GJM1555C1H7R6CB01#	
				±0.1pF	GJM1555C1H6R3BB01#	±0.5pF			GJM1555C1H7R6DB01#		
				±0.25pF	GJM1555C1H6R3CB01#	7.7pF			±0.05pF	GJM1555C1H7R7WB01#	
			±0.5pF	GJM1555C1H6R3DB01#	±0.1pF				GJM1555C1H7R7BB01#		
			6.4pF	±0.05pF	GJM1555C1H6R4WB01#				±0.25pF	GJM1555C1H7R7CB01#	
				±0.1pF	GJM1555C1H6R4BB01#	±0.5pF			GJM1555C1H7R7DB01#		
				±0.25pF	GJM1555C1H6R4CB01#	7.8pF			±0.05pF	GJM1555C1H7R8WB01#	
				±0.5pF	GJM1555C1H6R4DB01#				±0.1pF	GJM1555C1H7R8BB01#	
			6.5pF	±0.05pF	GJM1555C1H6R5WB01#				±0.25pF	GJM1555C1H7R8CB01#	
				±0.1pF	GJM1555C1H6R5BB01#	±0.5pF			GJM1555C1H7R8DB01#		
				±0.25pF	GJM1555C1H6R5CB01#	7.9pF			±0.05pF	GJM1555C1H7R9WB01#	
				±0.5pF	GJM1555C1H6R5DB01#				±0.1pF	GJM1555C1H7R9BB01#	
			6.6pF	±0.05pF	GJM1555C1H6R6WB01#				±0.25pF	GJM1555C1H7R9CB01#	
				±0.1pF	GJM1555C1H6R6BB01#	±0.5pF			GJM1555C1H7R9DB01#		
				±0.25pF	GJM1555C1H6R6CB01#	8.0pF			±0.05pF	GJM1555C1H8R0WB01#	
				±0.5pF	GJM1555C1H6R6DB01#				±0.1pF	GJM1555C1H8R0BB01#	
			6.7pF	±0.05pF	GJM1555C1H6R7WB01#				±0.25pF	GJM1555C1H8R0CB01#	
				±0.1pF	GJM1555C1H6R7BB01#	±0.5pF			GJM1555C1H8R0DB01#		
				±0.25pF	GJM1555C1H6R7CB01#	8.1pF			±0.05pF	GJM1555C1H8R1WB01#	
				±0.5pF	GJM1555C1H6R7DB01#				±0.1pF	GJM1555C1H8R1BB01#	
			6.8pF	±0.05pF	GJM1555C1H6R8WB01#				±0.25pF	GJM1555C1H8R1CB01#	
				±0.1pF	GJM1555C1H6R8BB01#	±0.5pF			GJM1555C1H8R1DB01#		
				±0.25pF	GJM1555C1H6R8CB01#	8.2pF			±0.05pF	GJM1555C1H8R2WB01#	
				±0.5pF	GJM1555C1H6R8DB01#				±0.1pF	GJM1555C1H8R2BB01#	
			6.9pF	±0.05pF	GJM1555C1H6R9WB01#				±0.25pF	GJM1555C1H8R2CB01#	
				±0.1pF	GJM1555C1H6R9BB01#	±0.5pF			GJM1555C1H8R2DB01#		
				±0.25pF	GJM1555C1H6R9CB01#	8.3pF			±0.05pF	GJM1555C1H8R3WB01#	
				±0.5pF	GJM1555C1H6R9DB01#				±0.1pF	GJM1555C1H8R3BB01#	
			7.0pF	±0.05pF	GJM1555C1H7R0WB01#				±0.25pF	GJM1555C1H8R3CB01#	
				±0.1pF	GJM1555C1H7R0BB01#	±0.5pF			GJM1555C1H8R3DB01#		
				±0.25pF	GJM1555C1H7R0CB01#	8.4pF			±0.05pF	GJM1555C1H8R4WB01#	
				±0.5pF	GJM1555C1H7R0DB01#				±0.1pF	GJM1555C1H8R4BB01#	
			7.1pF	±0.05pF	GJM1555C1H7R1WB01#				±0.25pF	GJM1555C1H8R4CB01#	
				±0.1pF	GJM1555C1H7R1BB01#	±0.5pF			GJM1555C1H8R4DB01#		
				±0.25pF	GJM1555C1H7R1CB01#	8.5pF			±0.05pF	GJM1555C1H8R5WB01#	
				±0.5pF	GJM1555C1H7R1DB01#				±0.1pF	GJM1555C1H8R5BB01#	
			7.2pF	±0.05pF	GJM1555C1H7R2WB01#				±0.25pF	GJM1555C1H8R5CB01#	
				±0.1pF	GJM1555C1H7R2BB01#	±0.5pF			GJM1555C1H8R5DB01#		
				±0.25pF	GJM1555C1H7R2CB01#	8.6pF			±0.05pF	GJM1555C1H8R6WB01#	
				±0.5pF	GJM1555C1H7R2DB01#				±0.1pF	GJM1555C1H8R6BB01#	
			7.3pF	±0.05pF	GJM1555C1H7R3WB01#				±0.25pF	GJM1555C1H8R6CB01#	
				±0.1pF	GJM1555C1H7R3BB01#	±0.5pF			GJM1555C1H8R6DB01#		
				±0.25pF	GJM1555C1H7R3CB01#	8.7pF			±0.05pF	GJM1555C1H8R7WB01#	
				±0.5pF	GJM1555C1H7R3DB01#				±0.1pF	GJM1555C1H8R7BB01#	
			7.4pF	±0.05pF	GJM1555C1H7R4WB01#				±0.25pF	GJM1555C1H8R7CB01#	
				±0.1pF	GJM1555C1H7R4BB01#	±0.5pF			GJM1555C1H8R7DB01#		
				±0.25pF	GJM1555C1H7R4CB01#	8.8pF			±0.05pF	GJM1555C1H8R8WB01#	
				±0.5pF	GJM1555C1H7R4DB01#				±0.1pF	GJM1555C1H8R8BB01#	

GRM
 GR3
 GRJ
 GR4
GJM
 GQM
 GA2
 GA3 GB
 GA3 GD
 GA3 GF
 LLL
 LLA
 LLM
 LLR
 NFM
 KRM
 KR3
 GMA
 GMD
 ⚠Caution /Notice

Part number # indicates the package specification code.

GJM Series Temperature Compensating Type High Q Part Number List

(→ 1.0×0.5mm)

T max.	Rated Voltage	TC Code	Cap.	Tol.	Part Number	T max.	Rated Voltage	TC Code	Cap.	Tol.	Part Number	
0.55mm	50Vdc	COG	8.8pF	±0.25pF	GJM1555C1H8R8CB01#	0.55mm	50Vdc	COG	15pF	±2%	GJM1555C1H150GB01#	
				±0.5pF	GJM1555C1H8R8DB01#					±5%	GJM1555C1H150JB01#	
			8.9pF	±0.05pF	GJM1555C1H8R9WB01#				16pF	±2%	GJM1555C1H160GB01#	
				±0.1pF	GJM1555C1H8R9BB01#					±5%	GJM1555C1H160JB01#	
				±0.25pF	GJM1555C1H8R9CB01#					18pF	±2%	GJM1555C1H180GB01#
				±0.5pF	GJM1555C1H8R9DB01#						±5%	GJM1555C1H180JB01#
			9.0pF	±0.05pF	GJM1555C1H9R0WB01#				20pF	±2%	GJM1555C1H200GB01#	
				±0.1pF	GJM1555C1H9R0BB01#					±5%	GJM1555C1H200JB01#	
				±0.25pF	GJM1555C1H9R0CB01#				22pF	±1%	GJM1555C1H220FB01#	
				±0.5pF	GJM1555C1H9R0DB01#					±2%	GJM1555C1H220GB01#	
			9.1pF	±0.05pF	GJM1555C1H9R1WB01#				24pF	±5%	GJM1555C1H220JB01#	
				±0.1pF	GJM1555C1H9R1BB01#					±1%	GJM1555C1H240FB01#	
				±0.25pF	GJM1555C1H9R1CB01#					±2%	GJM1555C1H240GB01#	
				±0.5pF	GJM1555C1H9R1DB01#					±5%	GJM1555C1H240JB01#	
			9.2pF	±0.05pF	GJM1555C1H9R2WB01#				27pF	±1%	GJM1555C1H270FB01#	
				±0.1pF	GJM1555C1H9R2BB01#					±2%	GJM1555C1H270GB01#	
				±0.25pF	GJM1555C1H9R2CB01#					±5%	GJM1555C1H270JB01#	
				±0.5pF	GJM1555C1H9R2DB01#					30pF	±1%	GJM1555C1H300FB01#
			9.3pF	±0.05pF	GJM1555C1H9R3WB01#				±2%		GJM1555C1H300GB01#	
				±0.1pF	GJM1555C1H9R3BB01#				±5%		GJM1555C1H300JB01#	
			9.3pF	±0.25pF	GJM1555C1H9R3CB01#				33pF	±1%	GJM1555C1H330FB01#	
				±0.5pF	GJM1555C1H9R3DB01#					±2%	GJM1555C1H330GB01#	
				9.4pF	±0.05pF					GJM1555C1H9R4WB01#	±5%	GJM1555C1H330JB01#
			±0.1pF		GJM1555C1H9R4BB01#				36pF	±1%	GJM1555C1H360FB01#	
			±0.25pF		GJM1555C1H9R4CB01#					±2%	GJM1555C1H360GB01#	
			±0.5pF	GJM1555C1H9R4DB01#	±5%					GJM1555C1H360JB01#		
			9.5pF	±0.05pF	GJM1555C1H9R5WB01#				39pF	±1%	GJM1555C1H390FB01#	
				±0.1pF	GJM1555C1H9R5BB01#					±2%	GJM1555C1H390GB01#	
				±0.25pF	GJM1555C1H9R5CB01#					±5%	GJM1555C1H390JB01#	
				±0.5pF	GJM1555C1H9R5DB01#					43pF	±1%	GJM1555C1H430FB01#
			9.6pF	±0.05pF	GJM1555C1H9R6WB01#				±2%		GJM1555C1H430GB01#	
				±0.1pF	GJM1555C1H9R6BB01#				±5%		GJM1555C1H430JB01#	
			9.6pF	±0.25pF	GJM1555C1H9R6CB01#				47pF	±1%	GJM1555C1H470FB01#	
				±0.5pF	GJM1555C1H9R6DB01#					±2%	GJM1555C1H470GB01#	
				9.7pF	±0.05pF					GJM1555C1H9R7WB01#	±5%	GJM1555C1H470JB01#
			±0.1pF		GJM1555C1H9R7BB01#				CK	±0.05pF	GJM1554C1HR10WB01#	
			±0.25pF		GJM1555C1H9R7CB01#					±0.1pF	GJM1554C1HR10BB01#	
			±0.5pF	GJM1555C1H9R7DB01#	±0.05pF					GJM1554C1HR20WB01#		
			9.8pF	±0.05pF	GJM1555C1H9R8WB01#				±0.1pF	GJM1554C1HR20BB01#		
				±0.1pF	GJM1555C1H9R8BB01#				0.30pF	±0.05pF	GJM1554C1HR30WB01#	
				±0.25pF	GJM1555C1H9R8CB01#					±0.1pF	GJM1554C1HR30BB01#	
				±0.5pF	GJM1555C1H9R8DB01#				0.40pF	±0.05pF	GJM1554C1HR40WB01#	
			9.9pF	±0.05pF	GJM1555C1H9R9WB01#					±0.1pF	GJM1554C1HR40BB01#	
				±0.1pF	GJM1555C1H9R9BB01#				0.50pF	±0.05pF	GJM1554C1HR50WB01#	
			±0.25pF	GJM1555C1H9R9CB01#	±0.1pF					GJM1554C1HR50BB01#		
			±0.5pF	GJM1555C1H9R9DB01#	0.60pF				±0.05pF	GJM1554C1HR60WB01#		
			10pF	±2%					GJM1555C1H100GB01#	±0.1pF	GJM1554C1HR60BB01#	
				±5%	GJM1555C1H100JB01#				0.70pF	±0.05pF	GJM1554C1HR70WB01#	
			11pF	±2%	GJM1555C1H110GB01#					±0.1pF	GJM1554C1HR70BB01#	
				±5%	GJM1555C1H110JB01#				0.80pF	±0.05pF	GJM1554C1HR80WB01#	
			12pF	±2%	GJM1555C1H120GB01#					±0.1pF	GJM1554C1HR80BB01#	
				±5%	GJM1555C1H120JB01#				0.90pF	±0.05pF	GJM1554C1HR90WB01#	
			13pF	±2%	GJM1555C1H130GB01#					±0.1pF	GJM1554C1HR90BB01#	
				±5%	GJM1555C1H130JB01#				1.0pF	±0.05pF	GJM1554C1H1R0WB01#	

GRM
 GR3
 GRJ
 GR4
GJM
 GQM
 GA2
 GA3 GB
 GA3 GD
 GA3 GF
 LLL
 LLA
 LLM
 LLR
 NFM
 KRM
 KR3
 GMA
 GMD
 ⚠Caution /Notice

Part number # indicates the package specification code.

GJM Series Temperature Compensating Type High Q Part Number List

(→ 1.0×0.5mm)

T max.	Rated Voltage	TC Code	Cap.	Tol.	Part Number	T max.	Rated Voltage	TC Code	Cap.	Tol.	Part Number	
0.55mm	50Vdc	CK	1.0pF	±0.1pF	GJM1554C1H1R0BB01#	0.55mm	50Vdc	CJ	2.8pF	±0.1pF	GJM1553C1H2R8BB01#	
				±0.25pF	GJM1554C1H1R0CB01#					±0.25pF	GJM1553C1H2R8CB01#	
				1.1pF	±0.05pF					GJM1554C1H1R1WB01#	2.9pF	±0.05pF
			±0.1pF		GJM1554C1H1R1BB01#				±0.1pF	GJM1553C1H2R9BB01#		
			±0.25pF		GJM1554C1H1R1CB01#				±0.25pF	GJM1553C1H2R9CB01#		
			1.2pF	±0.05pF	GJM1554C1H1R2WB01#				3.0pF	±0.05pF	GJM1553C1H3R0WB01#	
				±0.1pF	GJM1554C1H1R2BB01#					±0.1pF	GJM1553C1H3R0BB01#	
				±0.25pF	GJM1554C1H1R2CB01#					±0.25pF	GJM1553C1H3R0CB01#	
			1.3pF	±0.05pF	GJM1554C1H1R3WB01#				3.1pF	±0.05pF	GJM1553C1H3R1WB01#	
				±0.1pF	GJM1554C1H1R3BB01#					±0.1pF	GJM1553C1H3R1BB01#	
				±0.25pF	GJM1554C1H1R3CB01#					±0.25pF	GJM1553C1H3R1CB01#	
			1.4pF	±0.05pF	GJM1554C1H1R4WB01#				3.2pF	±0.05pF	GJM1553C1H3R2WB01#	
				±0.1pF	GJM1554C1H1R4BB01#					±0.1pF	GJM1553C1H3R2BB01#	
				±0.25pF	GJM1554C1H1R4CB01#					±0.25pF	GJM1553C1H3R2CB01#	
			1.5pF	±0.05pF	GJM1554C1H1R5WB01#				3.3pF	±0.05pF	GJM1553C1H3R3WB01#	
				±0.1pF	GJM1554C1H1R5BB01#					±0.1pF	GJM1553C1H3R3BB01#	
				±0.25pF	GJM1554C1H1R5CB01#					±0.25pF	GJM1553C1H3R3CB01#	
			1.6pF	±0.05pF	GJM1554C1H1R6WB01#				3.4pF	±0.05pF	GJM1553C1H3R4WB01#	
				±0.1pF	GJM1554C1H1R6BB01#					±0.1pF	GJM1553C1H3R4BB01#	
				±0.25pF	GJM1554C1H1R6CB01#					±0.25pF	GJM1553C1H3R4CB01#	
			1.7pF	±0.05pF	GJM1554C1H1R7WB01#				3.5pF	±0.05pF	GJM1553C1H3R5WB01#	
				±0.1pF	GJM1554C1H1R7BB01#					±0.1pF	GJM1553C1H3R5BB01#	
				±0.25pF	GJM1554C1H1R7CB01#					±0.25pF	GJM1553C1H3R5CB01#	
			1.8pF	±0.05pF	GJM1554C1H1R8WB01#				3.6pF	±0.05pF	GJM1553C1H3R6WB01#	
		±0.1pF		GJM1554C1H1R8BB01#	±0.1pF	GJM1553C1H3R6BB01#						
		±0.25pF		GJM1554C1H1R8CB01#	±0.25pF	GJM1553C1H3R6CB01#						
		1.9pF	±0.05pF	GJM1554C1H1R9WB01#	3.7pF	±0.05pF	GJM1553C1H3R7WB01#					
			±0.1pF	GJM1554C1H1R9BB01#		±0.1pF	GJM1553C1H3R7BB01#					
			±0.25pF	GJM1554C1H1R9CB01#		±0.25pF	GJM1553C1H3R7CB01#					
		2.0pF	±0.05pF	GJM1554C1H2R0WB01#	3.8pF	±0.05pF	GJM1553C1H3R8WB01#					
			±0.1pF	GJM1554C1H2R0BB01#		±0.1pF	GJM1553C1H3R8BB01#					
			±0.25pF	GJM1554C1H2R0CB01#		±0.25pF	GJM1553C1H3R8CB01#					
		CJ	50Vdc	2.1pF	±0.05pF	GJM1553C1H2R1WB01#	0.55mm	50Vdc	CH	4.0pF	±0.05pF	GJM1552C1H4R0WB01#
					±0.1pF	GJM1553C1H2R1BB01#					±0.1pF	GJM1552C1H4R0BB01#
					±0.25pF	GJM1553C1H2R1CB01#					±0.25pF	GJM1552C1H4R0CB01#
				2.2pF	±0.05pF	GJM1553C1H2R2WB01#				4.1pF	±0.05pF	GJM1552C1H4R1WB01#
					±0.1pF	GJM1553C1H2R2BB01#					±0.1pF	GJM1552C1H4R1BB01#
					±0.25pF	GJM1553C1H2R2CB01#					±0.25pF	GJM1552C1H4R1CB01#
				2.3pF	±0.05pF	GJM1553C1H2R3WB01#				4.2pF	±0.05pF	GJM1552C1H4R2WB01#
					±0.1pF	GJM1553C1H2R3BB01#					±0.1pF	GJM1552C1H4R2BB01#
					±0.25pF	GJM1553C1H2R3CB01#					±0.25pF	GJM1552C1H4R2CB01#
				2.4pF	±0.05pF	GJM1553C1H2R4WB01#				4.3pF	±0.05pF	GJM1552C1H4R3WB01#
					±0.1pF	GJM1553C1H2R4BB01#					±0.1pF	GJM1552C1H4R3BB01#
					±0.25pF	GJM1553C1H2R4CB01#					±0.25pF	GJM1552C1H4R3CB01#
				2.5pF	±0.05pF	GJM1553C1H2R5WB01#				4.4pF	±0.05pF	GJM1552C1H4R4WB01#
					±0.1pF	GJM1553C1H2R5BB01#					±0.1pF	GJM1552C1H4R4BB01#
					±0.25pF	GJM1553C1H2R5CB01#					±0.25pF	GJM1552C1H4R4CB01#
				2.6pF	±0.05pF	GJM1553C1H2R6WB01#				4.5pF	±0.05pF	GJM1552C1H4R5WB01#
±0.1pF	GJM1553C1H2R6BB01#				±0.1pF	GJM1552C1H4R5BB01#						
±0.25pF	GJM1553C1H2R6CB01#				±0.25pF	GJM1552C1H4R5CB01#						
2.7pF	±0.05pF			GJM1553C1H2R7WB01#	4.6pF	±0.05pF				GJM1552C1H4R6WB01#		
	±0.1pF			GJM1553C1H2R7BB01#		±0.1pF				GJM1552C1H4R6BB01#		
	±0.25pF			GJM1553C1H2R7CB01#		±0.25pF				GJM1552C1H4R6CB01#		
2.8pF	±0.05pF			GJM1553C1H2R8WB01#								

Part number # indicates the package specification code.

GRM
 GR3
 GRJ
 GR4
 GJM
 GQM
 GA2
 GA3 GB
 GA3 GD
 GA3 GF
 LLL
 LLA
 LLM
 LLR
 NFM
 KRM
 KR3
 GMA
 GMD
 ⚠Caution /Notice

GJM Series Temperature Compensating Type **High Q** Part Number List

(→ 1.0×0.5mm)

T max.	Rated Voltage	TC Code	Cap.	Tol.	Part Number	T max.	Rated Voltage	TC Code	Cap.	Tol.	Part Number
0.55mm	50Vdc	CH	4.6pF	±0.1pF	GJM1552C1H4R6BB01#	0.55mm	50Vdc	CH	6.1pF	±0.05pF	GJM1552C1H6R1WB01#
				±0.25pF	GJM1552C1H4R6CB01#					±0.1pF	GJM1552C1H6R1BB01#
			4.7pF	±0.05pF	GJM1552C1H4R7WB01#				±0.25pF	GJM1552C1H6R1CB01#	
				±0.1pF	GJM1552C1H4R7BB01#				±0.5pF	GJM1552C1H6R1DB01#	
			4.8pF	±0.25pF	GJM1552C1H4R7CB01#				6.2pF	±0.05pF	GJM1552C1H6R2WB01#
				±0.05pF	GJM1552C1H4R8WB01#					±0.1pF	GJM1552C1H6R2BB01#
				±0.1pF	GJM1552C1H4R8BB01#					±0.25pF	GJM1552C1H6R2CB01#
			4.9pF	±0.25pF	GJM1552C1H4R8CB01#				±0.5pF	GJM1552C1H6R2DB01#	
				±0.05pF	GJM1552C1H4R9WB01#				6.3pF	±0.05pF	GJM1552C1H6R3WB01#
				±0.1pF	GJM1552C1H4R9BB01#					±0.1pF	GJM1552C1H6R3BB01#
			±0.25pF	GJM1552C1H4R9CB01#	±0.25pF					GJM1552C1H6R3CB01#	
			5.0pF	±0.05pF	GJM1552C1H5R0WB01#				±0.5pF	GJM1552C1H6R3DB01#	
				±0.1pF	GJM1552C1H5R0BB01#				6.4pF	±0.05pF	GJM1552C1H6R4WB01#
				±0.25pF	GJM1552C1H5R0CB01#					±0.1pF	GJM1552C1H6R4BB01#
			±0.05pF	GJM1552C1H5R1WB01#	±0.25pF					GJM1552C1H6R4CB01#	
			5.1pF	±0.1pF	GJM1552C1H5R1BB01#				±0.5pF	GJM1552C1H6R4DB01#	
				±0.25pF	GJM1552C1H5R1CB01#				6.5pF	±0.05pF	GJM1552C1H6R5WB01#
				±0.5pF	GJM1552C1H5R1DB01#					±0.1pF	GJM1552C1H6R5BB01#
			±0.05pF	GJM1552C1H5R2WB01#	±0.25pF					GJM1552C1H6R5CB01#	
			5.2pF	±0.1pF	GJM1552C1H5R2BB01#				±0.5pF	GJM1552C1H6R5DB01#	
				±0.25pF	GJM1552C1H5R2CB01#				6.6pF	±0.05pF	GJM1552C1H6R6WB01#
				±0.5pF	GJM1552C1H5R2DB01#					±0.1pF	GJM1552C1H6R6BB01#
			±0.05pF	GJM1552C1H5R3WB01#	±0.25pF					GJM1552C1H6R6CB01#	
			5.3pF	±0.1pF	GJM1552C1H5R3BB01#				±0.5pF	GJM1552C1H6R6DB01#	
				±0.25pF	GJM1552C1H5R3CB01#				6.7pF	±0.05pF	GJM1552C1H6R7WB01#
				±0.5pF	GJM1552C1H5R3DB01#					±0.1pF	GJM1552C1H6R7BB01#
			±0.05pF	GJM1552C1H5R4WB01#	±0.25pF					GJM1552C1H6R7CB01#	
			5.4pF	±0.1pF	GJM1552C1H5R4BB01#				±0.5pF	GJM1552C1H6R7DB01#	
				±0.25pF	GJM1552C1H5R4CB01#				6.8pF	±0.05pF	GJM1552C1H6R8WB01#
				±0.5pF	GJM1552C1H5R4DB01#					±0.1pF	GJM1552C1H6R8BB01#
			±0.05pF	GJM1552C1H5R5WB01#	±0.25pF					GJM1552C1H6R8CB01#	
			5.5pF	±0.1pF	GJM1552C1H5R5BB01#				±0.5pF	GJM1552C1H6R8DB01#	
				±0.25pF	GJM1552C1H5R5CB01#				6.9pF	±0.05pF	GJM1552C1H6R9WB01#
				±0.5pF	GJM1552C1H5R5DB01#					±0.1pF	GJM1552C1H6R9BB01#
			±0.05pF	GJM1552C1H5R6WB01#	±0.25pF					GJM1552C1H6R9CB01#	
			5.6pF	±0.1pF	GJM1552C1H5R6BB01#				±0.5pF	GJM1552C1H6R9DB01#	
				±0.25pF	GJM1552C1H5R6CB01#				7.0pF	±0.05pF	GJM1552C1H7R0WB01#
				±0.5pF	GJM1552C1H5R6DB01#					±0.1pF	GJM1552C1H7R0BB01#
			±0.05pF	GJM1552C1H5R7WB01#	±0.25pF					GJM1552C1H7R0CB01#	
			5.7pF	±0.1pF	GJM1552C1H5R7BB01#				±0.5pF	GJM1552C1H7R0DB01#	
				±0.25pF	GJM1552C1H5R7CB01#				7.1pF	±0.05pF	GJM1552C1H7R1WB01#
				±0.5pF	GJM1552C1H5R7DB01#					±0.1pF	GJM1552C1H7R1BB01#
			±0.05pF	GJM1552C1H5R8WB01#	±0.25pF					GJM1552C1H7R1CB01#	
			5.8pF	±0.1pF	GJM1552C1H5R8BB01#				±0.5pF	GJM1552C1H7R1DB01#	
				±0.25pF	GJM1552C1H5R8CB01#				7.2pF	±0.05pF	GJM1552C1H7R2WB01#
				±0.5pF	GJM1552C1H5R8DB01#					±0.1pF	GJM1552C1H7R2BB01#
			±0.05pF	GJM1552C1H5R9WB01#	±0.25pF					GJM1552C1H7R2CB01#	
			5.9pF	±0.1pF	GJM1552C1H5R9BB01#				±0.5pF	GJM1552C1H7R2DB01#	
±0.25pF	GJM1552C1H5R9CB01#	7.3pF		±0.05pF	GJM1552C1H7R3WB01#						
±0.5pF	GJM1552C1H5R9DB01#			±0.1pF	GJM1552C1H7R3BB01#						
±0.05pF	GJM1552C1H6R0WB01#		±0.25pF	GJM1552C1H7R3CB01#							
6.0pF	±0.1pF	GJM1552C1H6R0BB01#	±0.5pF	GJM1552C1H7R3DB01#							
	±0.25pF	GJM1552C1H6R0CB01#	7.4pF	±0.05pF	GJM1552C1H7R4WB01#						
	±0.5pF	GJM1552C1H6R0DB01#		±0.1pF	GJM1552C1H7R4BB01#						

- GRM
- GR3
- GRJ
- GR4
- GJM**
- GQM
- GA2
- GA3 GB
- GA3 GD
- GA3 GF
- LLL
- LLA
- LLM
- LLR
- NFM
- KRM
- KR3
- GMA
- GMD
- ⚠Caution /Notice

Part number # indicates the package specification code.

GJM Series Temperature Compensating Type High Q Part Number List

(→ 1.0×0.5mm)

T max.	Rated Voltage	TC Code	Cap.	Tol.	Part Number	T max.	Rated Voltage	TC Code	Cap.	Tol.	Part Number
0.55mm	50Vdc	CH	7.4pF	±0.25pF	GJM1552C1H7R4CB01#	0.55mm	50Vdc	CH	8.8pF	±0.05pF	GJM1552C1H8R8WB01#
				±0.5pF	GJM1552C1H7R4DB01#					±0.1pF	GJM1552C1H8R8BB01#
			7.5pF	±0.05pF	GJM1552C1H7R5WB01#				±0.25pF	GJM1552C1H8R8CB01#	
				±0.1pF	GJM1552C1H7R5BB01#				±0.5pF	GJM1552C1H8R8DB01#	
				±0.25pF	GJM1552C1H7R5CB01#				8.9pF	±0.05pF	GJM1552C1H8R9WB01#
				±0.5pF	GJM1552C1H7R5DB01#					±0.1pF	GJM1552C1H8R9BB01#
			7.6pF	±0.05pF	GJM1552C1H7R6WB01#					±0.25pF	GJM1552C1H8R9CB01#
				±0.1pF	GJM1552C1H7R6BB01#				±0.5pF	GJM1552C1H8R9DB01#	
				±0.25pF	GJM1552C1H7R6CB01#				9.0pF	±0.05pF	GJM1552C1H9ROWB01#
			±0.5pF	GJM1552C1H7R6DB01#	±0.1pF					GJM1552C1H9ROBB01#	
			7.7pF	±0.05pF	GJM1552C1H7R7WB01#					±0.25pF	GJM1552C1H9ROCB01#
				±0.1pF	GJM1552C1H7R7BB01#				±0.5pF	GJM1552C1H9RODB01#	
				±0.25pF	GJM1552C1H7R7CB01#				9.1pF	±0.05pF	GJM1552C1H9R1WB01#
				±0.5pF	GJM1552C1H7R7DB01#					±0.1pF	GJM1552C1H9R1BB01#
			7.8pF	±0.05pF	GJM1552C1H7R8WB01#					±0.25pF	GJM1552C1H9R1CB01#
				±0.1pF	GJM1552C1H7R8BB01#				±0.5pF	GJM1552C1H9R1DB01#	
				±0.25pF	GJM1552C1H7R8CB01#				9.2pF	±0.05pF	GJM1552C1H9R2WB01#
				±0.5pF	GJM1552C1H7R8DB01#					±0.1pF	GJM1552C1H9R2BB01#
			7.9pF	±0.05pF	GJM1552C1H7R9WB01#					±0.25pF	GJM1552C1H9R2CB01#
				±0.1pF	GJM1552C1H7R9BB01#				±0.5pF	GJM1552C1H9R2DB01#	
				±0.25pF	GJM1552C1H7R9CB01#				9.3pF	±0.05pF	GJM1552C1H9R3WB01#
				±0.5pF	GJM1552C1H7R9DB01#					±0.1pF	GJM1552C1H9R3BB01#
			8.0pF	±0.05pF	GJM1552C1H8R0WB01#					±0.25pF	GJM1552C1H9R3CB01#
				±0.1pF	GJM1552C1H8R0BB01#				±0.5pF	GJM1552C1H9R3DB01#	
				±0.25pF	GJM1552C1H8R0CB01#				9.4pF	±0.05pF	GJM1552C1H9R4WB01#
				±0.5pF	GJM1552C1H8R0DB01#					±0.1pF	GJM1552C1H9R4BB01#
			8.1pF	±0.05pF	GJM1552C1H8R1WB01#					±0.25pF	GJM1552C1H9R4CB01#
				±0.1pF	GJM1552C1H8R1BB01#				±0.5pF	GJM1552C1H9R4DB01#	
				±0.25pF	GJM1552C1H8R1CB01#				9.5pF	±0.05pF	GJM1552C1H9R5WB01#
				±0.5pF	GJM1552C1H8R1DB01#					±0.1pF	GJM1552C1H9R5BB01#
			8.2pF	±0.05pF	GJM1552C1H8R2WB01#					±0.25pF	GJM1552C1H9R5CB01#
				±0.1pF	GJM1552C1H8R2BB01#				±0.5pF	GJM1552C1H9R5DB01#	
				±0.25pF	GJM1552C1H8R2CB01#				9.6pF	±0.05pF	GJM1552C1H9R6WB01#
				±0.5pF	GJM1552C1H8R2DB01#					±0.1pF	GJM1552C1H9R6BB01#
			8.3pF	±0.05pF	GJM1552C1H8R3WB01#					±0.25pF	GJM1552C1H9R6CB01#
				±0.1pF	GJM1552C1H8R3BB01#				±0.5pF	GJM1552C1H9R6DB01#	
				±0.25pF	GJM1552C1H8R3CB01#				9.7pF	±0.05pF	GJM1552C1H9R7WB01#
				±0.5pF	GJM1552C1H8R3DB01#					±0.1pF	GJM1552C1H9R7BB01#
			8.4pF	±0.05pF	GJM1552C1H8R4WB01#					±0.25pF	GJM1552C1H9R7CB01#
				±0.1pF	GJM1552C1H8R4BB01#				±0.5pF	GJM1552C1H9R7DB01#	
				±0.25pF	GJM1552C1H8R4CB01#				9.8pF	±0.05pF	GJM1552C1H9R8WB01#
				±0.5pF	GJM1552C1H8R4DB01#					±0.1pF	GJM1552C1H9R8BB01#
			8.5pF	±0.05pF	GJM1552C1H8R5WB01#					±0.25pF	GJM1552C1H9R8CB01#
				±0.1pF	GJM1552C1H8R5BB01#				±0.5pF	GJM1552C1H9R8DB01#	
				±0.25pF	GJM1552C1H8R5CB01#				9.9pF	±0.05pF	GJM1552C1H9R9WB01#
				±0.5pF	GJM1552C1H8R5DB01#					±0.1pF	GJM1552C1H9R9BB01#
			8.6pF	±0.05pF	GJM1552C1H8R6WB01#					±0.25pF	GJM1552C1H9R9CB01#
				±0.1pF	GJM1552C1H8R6BB01#				±0.5pF	GJM1552C1H9R9DB01#	
				±0.25pF	GJM1552C1H8R6CB01#				10pF	±2%	GJM1552C1H100GB01#
				±0.5pF	GJM1552C1H8R6DB01#					±5%	GJM1552C1H100JB01#
			8.7pF	±0.05pF	GJM1552C1H8R7WB01#					11pF	±2%
				±0.1pF	GJM1552C1H8R7BB01#				±5%		GJM1552C1H110JB01#
				±0.25pF	GJM1552C1H8R7CB01#				12pF		±2%
				±0.5pF	GJM1552C1H8R7DB01#					±5%	GJM1552C1H120JB01#

- GRM
- GR3
- GRJ
- GR4
- GJM
- GQM
- GA2
- GA3 GB
- GA3 GD
- GA3 GF
- LLL
- LLA
- LLM
- LLR
- NFM
- KRM
- KR3
- GMA
- GMD
- ⚠Caution /Notice

Part number # indicates the package specification code.

GJM Series Temperature Compensating Type High Q Part Number List

(→ 1.0×0.5mm)

T max.	Rated Voltage	TC Code	Cap.	Tol.	Part Number
0.55mm	50Vdc	CH	13pF	±2%	GJM1552C1H130GB01#
				±5%	GJM1552C1H130JB01#
			15pF	±2%	GJM1552C1H150GB01#
				±5%	GJM1552C1H150JB01#
			16pF	±2%	GJM1552C1H160GB01#
				±5%	GJM1552C1H160JB01#
			18pF	±2%	GJM1552C1H180GB01#
				±5%	GJM1552C1H180JB01#
			20pF	±2%	GJM1552C1H200GB01#
				±5%	GJM1552C1H200JB01#
			22pF	±1%	GJM1552C1H220FB01#
				±2%	GJM1552C1H220GB01#
				±5%	GJM1552C1H220JB01#
			24pF	±1%	GJM1552C1H240FB01#
				±2%	GJM1552C1H240GB01#
				±5%	GJM1552C1H240JB01#
			27pF	±1%	GJM1552C1H270FB01#
				±2%	GJM1552C1H270GB01#
				±5%	GJM1552C1H270JB01#
			30pF	±1%	GJM1552C1H300FB01#
				±2%	GJM1552C1H300GB01#
				±5%	GJM1552C1H300JB01#
			33pF	±1%	GJM1552C1H330FB01#
				±2%	GJM1552C1H330GB01#
				±5%	GJM1552C1H330JB01#
			36pF	±1%	GJM1552C1H360FB01#
				±2%	GJM1552C1H360GB01#
				±5%	GJM1552C1H360JB01#
			39pF	±1%	GJM1552C1H390FB01#
				±2%	GJM1552C1H390GB01#
				±5%	GJM1552C1H390JB01#
			43pF	±1%	GJM1552C1H430FB01#
				±2%	GJM1552C1H430GB01#
				±5%	GJM1552C1H430JB01#
			47pF	±1%	GJM1552C1H470FB01#
				±2%	GJM1552C1H470GB01#
				±5%	GJM1552C1H470JB01#

- GRM
- GR3
- GRJ
- GR4
- GJM
- GQM
- GA2
- GA3 GB
- GA3 GD
- GA3 GF
- LLL
- LLA
- LLM
- LLR
- NFM
- KRM
- KR3
- GMA
- GMD
- △Caution /Notice

Part number # indicates the package specification code.

High Q and High Power Chip Multilayer Ceramic Capacitors for General Purpose

GQM Series



High Frequency Capacitor Ideal for PA Design of Base Stations

Features

- ① **Mainly ideal for base stations of mobile communication devices and temperature compensation of related modules.**

This product is ideal for temperature compensation of high frequency circuits, such as resonant circuits, tuning circuits, and impedance matching circuits where the operating characteristics of the device are greatly affected by the capacitance fluctuation.

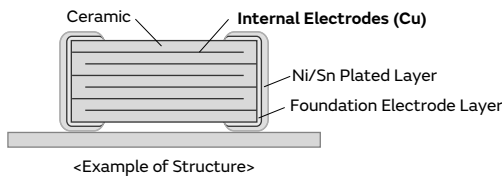

- ② **High Q and low ESR in VHF, UHF and microwave frequency bands.**

High Q and low ESR were achieved at a high frequency by adopting ceramic material as the dielectric material which enables an extremely low loss at high frequency, and base metal electrodes as the internal electrodes.

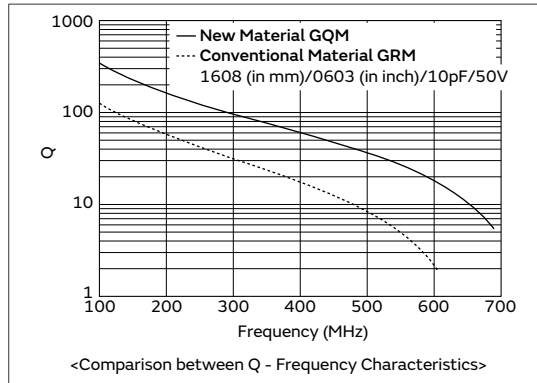
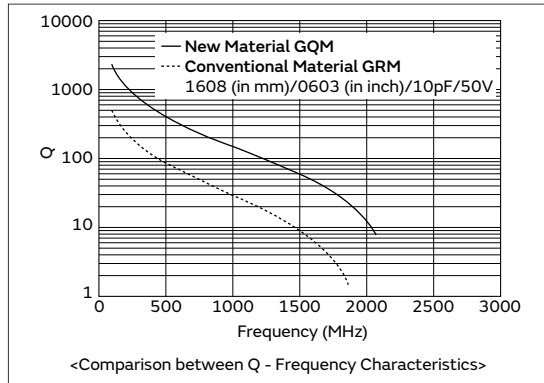

- ③ **Can be used for tight tolerance.**

In addition to standard tolerance, the allowable range of this product is also suitable for the following narrow tolerance.

Capacitance Range	Standard Capacitance Tolerance (Capacitance Tolerance Symbol)	Narrow Capacitance Tolerance (Capacitance Tolerance Symbol)
to 0.9pF	±0.1pF (B)	±0.05pF (W)
1.0 to 5.0pF	±0.25pF (C)	±0.05pF (W), ±0.1pF (B)
5.1 to 9.9pF	±0.5pF (D)	±0.05pF (W), ±0.1pF (B), ±0.25pF (C)
10pF to	±5% (J)	±2% (G)

Specifications

Size (mm)	1.0×0.5mm to 2.8×2.8mm
Rated Voltage	100Vdc to 500Vdc
Capacitance	0.10pF to 510pF
Main Applications	Measuring instruments, other ultra compact/thin devices

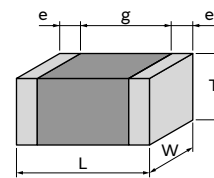

<Dimensions>

This catalog contains only a portion of the product lineup.
 Please refer to the capacitor search tool on the Murata Web site for details.

GQM Series Temperature Compensating Type High Q Part Number List

1.0×0.5mm

T max.	Rated Voltage	TC Code	Cap.	Tol.	Part Number
0.55mm	200Vdc	COG	0.10pF	±0.1pF	GQM1555C2DR10BB01#
				±0.25pF	GQM1555C2DR10CB01#
			0.20pF	±0.1pF	GQM1555C2DR20BB01#
				±0.25pF	GQM1555C2DR20CB01#
			0.30pF	±0.1pF	GQM1555C2DR30BB01#
				±0.25pF	GQM1555C2DR30CB01#
			0.40pF	±0.1pF	GQM1555C2DR40BB01#
				±0.25pF	GQM1555C2DR40CB01#
			0.50pF	±0.1pF	GQM1555C2DR50BB01#
				±0.25pF	GQM1555C2DR50CB01#
			0.60pF	±0.1pF	GQM1555C2DR60BB01#
				±0.25pF	GQM1555C2DR60CB01#
			0.70pF	±0.1pF	GQM1555C2DR70BB01#
				±0.25pF	GQM1555C2DR70CB01#
			0.75pF	±0.1pF	GQM1555C2DR75BB01#
				±0.25pF	GQM1555C2DR75CB01#
			0.80pF	±0.1pF	GQM1555C2DR80BB01#
				±0.25pF	GQM1555C2DR80CB01#
			0.90pF	±0.1pF	GQM1555C2DR90BB01#
				±0.25pF	GQM1555C2DR90CB01#
			1.0pF	±0.1pF	GQM1555C2D1R0BB01#
				±0.25pF	GQM1555C2D1R0CB01#
			1.1pF	±0.1pF	GQM1555C2D1R1BB01#
				±0.25pF	GQM1555C2D1R1CB01#
			1.2pF	±0.1pF	GQM1555C2D1R2BB01#
				±0.25pF	GQM1555C2D1R2CB01#
			1.3pF	±0.1pF	GQM1555C2D1R3BB01#
				±0.25pF	GQM1555C2D1R3CB01#
			1.5pF	±0.1pF	GQM1555C2D1R5BB01#
				±0.25pF	GQM1555C2D1R5CB01#
			1.6pF	±0.1pF	GQM1555C2D1R6BB01#
				±0.25pF	GQM1555C2D1R6CB01#
			1.8pF	±0.1pF	GQM1555C2D1R8BB01#
				±0.25pF	GQM1555C2D1R8CB01#
			2.0pF	±0.1pF	GQM1555C2D2R0BB01#
				±0.25pF	GQM1555C2D2R0CB01#
			2.2pF	±0.1pF	GQM1555C2D2R2BB01#
				±0.25pF	GQM1555C2D2R2CB01#
			2.4pF	±0.1pF	GQM1555C2D2R4BB01#
				±0.25pF	GQM1555C2D2R4CB01#
			2.7pF	±0.1pF	GQM1555C2D2R7BB01#
				±0.25pF	GQM1555C2D2R7CB01#
			3.0pF	±0.1pF	GQM1555C2D3R0BB01#
				±0.25pF	GQM1555C2D3R0CB01#
			3.3pF	±0.1pF	GQM1555C2D3R3BB01#
				±0.25pF	GQM1555C2D3R3CB01#
			3.6pF	±0.1pF	GQM1555C2D3R6BB01#
				±0.25pF	GQM1555C2D3R6CB01#
3.9pF	±0.1pF	GQM1555C2D3R9BB01#			
	±0.25pF	GQM1555C2D3R9CB01#			
4.0pF	±0.1pF	GQM1555C2D4R0BB01#			
	±0.25pF	GQM1555C2D4R0CB01#			
4.3pF	±0.1pF	GQM1555C2D4R3BB01#			
	±0.25pF	GQM1555C2D4R3CB01#			

T max.	Rated Voltage	TC Code	Cap.	Tol.	Part Number
0.55mm	200Vdc	COG	4.7pF	±0.1pF	GQM1555C2D4R7BB01#
				±0.25pF	GQM1555C2D4R7CB01#
			5.0pF	±0.1pF	GQM1555C2D5R0BB01#
				±0.25pF	GQM1555C2D5R0CB01#
			5.1pF	±0.1pF	GQM1555C2D5R1BB01#
				±0.25pF	GQM1555C2D5R1CB01#
			5.6pF	±0.1pF	GQM1555C2D5R6BB01#
				±0.25pF	GQM1555C2D5R6CB01#
			6.0pF	±0.1pF	GQM1555C2D6R0BB01#
				±0.25pF	GQM1555C2D6R0CB01#
			6.2pF	±0.1pF	GQM1555C2D6R2BB01#
				±0.25pF	GQM1555C2D6R2CB01#
			6.8pF	±0.1pF	GQM1555C2D6R8BB01#
				±0.25pF	GQM1555C2D6R8CB01#
			7.0pF	±0.1pF	GQM1555C2D7R0BB01#
				±0.25pF	GQM1555C2D7R0CB01#
			7.5pF	±0.1pF	GQM1555C2D7R5BB01#
				±0.25pF	GQM1555C2D7R5CB01#
			8.0pF	±0.1pF	GQM1555C2D8R0BB01#
				±0.25pF	GQM1555C2D8R0CB01#
			8.2pF	±0.1pF	GQM1555C2D8R2BB01#
				±0.25pF	GQM1555C2D8R2CB01#
			9.0pF	±0.1pF	GQM1555C2D9R0BB01#
				±0.25pF	GQM1555C2D9R0CB01#
			9.1pF	±0.1pF	GQM1555C2D9R1BB01#
				±0.25pF	GQM1555C2D9R1CB01#
			10pF	±2%	GQM1555C2D100GB01#
				±5%	GQM1555C2D100JB01#
			11pF	±2%	GQM1555C2D110GB01#
				±5%	GQM1555C2D110JB01#
			12pF	±2%	GQM1555C2D120GB01#
				±5%	GQM1555C2D120JB01#
			13pF	±2%	GQM1555C2D130GB01#
				±5%	GQM1555C2D130JB01#
			15pF	±2%	GQM1555C2D150GB01#
				±5%	GQM1555C2D150JB01#
			16pF	±2%	GQM1555C2D160GB01#
				±5%	GQM1555C2D160JB01#
			18pF	±2%	GQM1555C2D180GB01#
				±5%	GQM1555C2D180JB01#
			20pF	±2%	GQM1555C2D200GB01#
				±5%	GQM1555C2D200JB01#
			22pF	±2%	GQM1555C2D220GB01#
				±5%	GQM1555C2D220JB01#
			24pF	±2%	GQM1555C2D240GB01#
				±5%	GQM1555C2D240JB01#
			27pF	±2%	GQM1555C2D270GB01#
				±5%	GQM1555C2D270JB01#
30pF	±2%	GQM1555C2D300GB01#			
	±5%	GQM1555C2D300JB01#			
33pF	±2%	GQM1555C2D330GB01#			
	±5%	GQM1555C2D330JB01#			
	100Vdc	COG	36pF	±2%	GQM1555C2A360GB01#
				±5%	GQM1555C2A360JB01#

Part number # indicates the package specification code.

GRM
 GR3
 GRJ
 GR4
 GJM
 GQM
 GA2
 GA3 GB
 GA3 GD
 GA3 GF
 LLL
 LLA
 LLM
 LLR
 NFM
 KRM
 KR3
 GMA
 GMD
 ⚠Caution /Notice

GQM Series Temperature Compensating Type High Q Part Number List

(→ 1.0×0.5mm)

T max.	Rated Voltage	TC Code	Cap.	Tol.	Part Number
0.55mm	100Vdc	COG	39pF	±2%	GQM1555C2A390GB01#
				±5%	GQM1555C2A390JB01#
			43pF	±2%	GQM1555C2A430GB01#
				±5%	GQM1555C2A430JB01#
			47pF	±2%	GQM1555C2A470GB01#
				±5%	GQM1555C2A470JB01#

1.6×0.8mm

T max.	Rated Voltage	TC Code	Cap.	Tol.	Part Number
0.8mm	250Vdc	COG	1.0pF	±0.1pF	GQM1875C2E1R0BB12#
				±0.25pF	GQM1875C2E1R0CB12#
			1.1pF	±0.1pF	GQM1875C2E1R1BB12#
				±0.25pF	GQM1875C2E1R1CB12#
			1.2pF	±0.1pF	GQM1875C2E1R2BB12#
				±0.25pF	GQM1875C2E1R2CB12#
			1.3pF	±0.1pF	GQM1875C2E1R3BB12#
				±0.25pF	GQM1875C2E1R3CB12#
			1.5pF	±0.1pF	GQM1875C2E1R5BB12#
				±0.25pF	GQM1875C2E1R5CB12#
			1.6pF	±0.1pF	GQM1875C2E1R6BB12#
				±0.25pF	GQM1875C2E1R6CB12#
			1.8pF	±0.1pF	GQM1875C2E1R8BB12#
				±0.25pF	GQM1875C2E1R8CB12#
			2.0pF	±0.1pF	GQM1875C2E2R0BB12#
				±0.25pF	GQM1875C2E2R0CB12#
			2.2pF	±0.1pF	GQM1875C2E2R2BB12#
				±0.25pF	GQM1875C2E2R2CB12#
			2.4pF	±0.1pF	GQM1875C2E2R4BB12#
				±0.25pF	GQM1875C2E2R4CB12#
			2.7pF	±0.1pF	GQM1875C2E2R7BB12#
				±0.25pF	GQM1875C2E2R7CB12#
			3.0pF	±0.1pF	GQM1875C2E3R0BB12#
				±0.25pF	GQM1875C2E3R0CB12#
			3.3pF	±0.1pF	GQM1875C2E3R3BB12#
				±0.25pF	GQM1875C2E3R3CB12#
			3.6pF	±0.1pF	GQM1875C2E3R6BB12#
				±0.25pF	GQM1875C2E3R6CB12#
			3.9pF	±0.1pF	GQM1875C2E3R9BB12#
				±0.25pF	GQM1875C2E3R9CB12#
			4.0pF	±0.1pF	GQM1875C2E4R0BB12#
				±0.25pF	GQM1875C2E4R0CB12#
			4.3pF	±0.1pF	GQM1875C2E4R3BB12#
				±0.25pF	GQM1875C2E4R3CB12#
			4.7pF	±0.1pF	GQM1875C2E4R7BB12#
				±0.25pF	GQM1875C2E4R7CB12#
			5.0pF	±0.1pF	GQM1875C2E5R0BB12#
				±0.25pF	GQM1875C2E5R0CB12#
			5.1pF	±0.25pF	GQM1875C2E5R1CB12#
				±0.5pF	GQM1875C2E5R1DB12#
			5.6pF	±0.25pF	GQM1875C2E5R6CB12#
				±0.5pF	GQM1875C2E5R6DB12#
			6.0pF	±0.25pF	GQM1875C2E6R0CB12#

T max.	Rated Voltage	TC Code	Cap.	Tol.	Part Number
0.8mm	250Vdc	COG	6.0pF	±0.5pF	GQM1875C2E6R0DB12#
				±0.25pF	GQM1875C2E6R2CB12#
			6.2pF	±0.5pF	GQM1875C2E6R2DB12#
				±0.25pF	GQM1875C2E6R8CB12#
			6.8pF	±0.25pF	GQM1875C2E6R8DB12#
				±0.5pF	GQM1875C2E7R0CB12#
			7.0pF	±0.25pF	GQM1875C2E7R0DB12#
				±0.5pF	GQM1875C2E7R5CB12#
			7.5pF	±0.25pF	GQM1875C2E7R5DB12#
				±0.5pF	GQM1875C2E8R0CB12#
			8.0pF	±0.25pF	GQM1875C2E8R0DB12#
				±0.5pF	GQM1875C2E8R2CB12#
			8.2pF	±0.25pF	GQM1875C2E8R2DB12#
				±0.5pF	GQM1875C2E9R0CB12#
			9.0pF	±0.25pF	GQM1875C2E9R0DB12#
				±0.5pF	GQM1875C2E9R1CB12#
			9.1pF	±0.25pF	GQM1875C2E9R1DB12#
				±0.5pF	GQM1875C2E100GB12#
			10pF	±2%	GQM1875C2E100JB12#
				±5%	GQM1875C2E100GB12#
			11pF	±2%	GQM1875C2E110GB12#
				±5%	GQM1875C2E110JB12#
			12pF	±2%	GQM1875C2E120GB12#
				±5%	GQM1875C2E120JB12#
			13pF	±2%	GQM1875C2E130GB12#
				±5%	GQM1875C2E130JB12#
			15pF	±2%	GQM1875C2E150GB12#
				±5%	GQM1875C2E150JB12#
			16pF	±2%	GQM1875C2E160GB12#
				±5%	GQM1875C2E160JB12#
			18pF	±2%	GQM1875C2E180GB12#
				±5%	GQM1875C2E180JB12#
			20pF	±2%	GQM1875C2E200GB12#
				±5%	GQM1875C2E200JB12#
			22pF	±2%	GQM1875C2E220GB12#
				±5%	GQM1875C2E220JB12#
			24pF	±2%	GQM1875C2E240GB12#
				±5%	GQM1875C2E240JB12#
			27pF	±2%	GQM1875C2E270GB12#
				±5%	GQM1875C2E270JB12#
			30pF	±2%	GQM1875C2E300GB12#
				±5%	GQM1875C2E300JB12#
33pF	±2%	GQM1875C2E330GB12#			
	±5%	GQM1875C2E330JB12#			
36pF	±2%	GQM1875C2E360GB12#			
	±5%	GQM1875C2E360JB12#			
39pF	±2%	GQM1875C2E390GB12#			
	±5%	GQM1875C2E390JB12#			
43pF	±2%	GQM1875C2E430GB12#			
	±5%	GQM1875C2E430JB12#			
47pF	±2%	GQM1875C2E470GB12#			
	±5%	GQM1875C2E470JB12#			
X8G	250Vdc	COG	1.0pF	±0.1pF	GQM1875G2E1R0BB12#
				±0.25pF	GQM1875G2E1R0CB12#
			1.1pF	±0.1pF	GQM1875G2E1R1BB12#

GRM
 GR3
 GRJ
 GR4
 GJM
 GQM
 GA2
 GA3 GB
 GA3 GD
 GA3 GF
 LLL
 LLA
 LLM
 LLR
 NFM
 KRM
 KR3
 GMA
 GMD
 ⚠Caution /Notice

Part number # indicates the package specification code.

GQM Series Temperature Compensating Type High Q Part Number List

(→ 1.6×0.8mm)

T max.	Rated Voltage	TC Code	Cap.	Tol.	Part Number
0.8mm	250Vdc	X8G	1.1pF	±0.25pF	GQM1875G2E1R1CB12#
				±0.1pF	GQM1875G2E1R2BB12#
			1.2pF	±0.25pF	GQM1875G2E1R2CB12#
				±0.1pF	GQM1875G2E1R3BB12#
			1.3pF	±0.25pF	GQM1875G2E1R3CB12#
				±0.1pF	GQM1875G2E1R5BB12#
			1.5pF	±0.25pF	GQM1875G2E1R5CB12#
				±0.1pF	GQM1875G2E1R6BB12#
			1.6pF	±0.25pF	GQM1875G2E1R6CB12#
				±0.1pF	GQM1875G2E1R8BB12#
			1.8pF	±0.25pF	GQM1875G2E1R8CB12#
				±0.1pF	GQM1875G2E2R0BB12#
			2.0pF	±0.25pF	GQM1875G2E2R0CB12#
				±0.1pF	GQM1875G2E2R2BB12#
			2.2pF	±0.25pF	GQM1875G2E2R2CB12#
				±0.1pF	GQM1875G2E2R4BB12#
			2.4pF	±0.25pF	GQM1875G2E2R4CB12#
				±0.1pF	GQM1875G2E2R7BB12#
			2.7pF	±0.25pF	GQM1875G2E2R7CB12#
				±0.1pF	GQM1875G2E3R0BB12#
			3.0pF	±0.25pF	GQM1875G2E3R0CB12#
				±0.1pF	GQM1875G2E3R3BB12#
			3.3pF	±0.25pF	GQM1875G2E3R3CB12#
				±0.1pF	GQM1875G2E3R6BB12#
			3.6pF	±0.25pF	GQM1875G2E3R6CB12#
				±0.1pF	GQM1875G2E3R9BB12#
			3.9pF	±0.25pF	GQM1875G2E3R9CB12#
				±0.1pF	GQM1875G2E4R0BB12#
			4.0pF	±0.25pF	GQM1875G2E4R0CB12#
				±0.1pF	GQM1875G2E4R3BB12#
			4.3pF	±0.25pF	GQM1875G2E4R3CB12#
				±0.1pF	GQM1875G2E4R7BB12#
			4.7pF	±0.25pF	GQM1875G2E4R7CB12#
				±0.1pF	GQM1875G2E5R0BB12#
			5.0pF	±0.25pF	GQM1875G2E5R0CB12#
				±0.1pF	GQM1875G2E5R1CB12#
			5.1pF	±0.5pF	GQM1875G2E5R1DB12#
				±0.25pF	GQM1875G2E5R6CB12#
			5.6pF	±0.5pF	GQM1875G2E5R6DB12#
				±0.25pF	GQM1875G2E6R0CB12#
			6.0pF	±0.5pF	GQM1875G2E6R0DB12#
				±0.25pF	GQM1875G2E6R2CB12#
			6.2pF	±0.5pF	GQM1875G2E6R2DB12#
				±0.25pF	GQM1875G2E6R8CB12#
			6.8pF	±0.5pF	GQM1875G2E6R8DB12#
				±0.25pF	GQM1875G2E7R0CB12#
			7.0pF	±0.5pF	GQM1875G2E7R0DB12#
				±0.25pF	GQM1875G2E7R5CB12#
			7.5pF	±0.5pF	GQM1875G2E7R5DB12#
				±0.25pF	GQM1875G2E8R0CB12#
			8.0pF	±0.5pF	GQM1875G2E8R0DB12#
				±0.25pF	GQM1875G2E8R2CB12#
			8.2pF	±0.5pF	GQM1875G2E8R2DB12#
				±0.25pF	GQM1875G2E9R0CB12#

T max.	Rated Voltage	TC Code	Cap.	Tol.	Part Number
0.8mm	250Vdc	X8G	9.0pF	±0.5pF	GQM1875G2E9R0DB12#
				±0.25pF	GQM1875G2E9R1CB12#
			9.1pF	±0.5pF	GQM1875G2E9R1DB12#
				±2%	GQM1875G2E100GB12#
			10pF	±5%	GQM1875G2E100JB12#
				±2%	GQM1875G2E110GB12#
			11pF	±5%	GQM1875G2E110JB12#
				±2%	GQM1875G2E120GB12#
			12pF	±5%	GQM1875G2E120JB12#
				±2%	GQM1875G2E130GB12#
			13pF	±5%	GQM1875G2E130JB12#
				±2%	GQM1875G2E150GB12#
			15pF	±5%	GQM1875G2E150JB12#
				±2%	GQM1875G2E160GB12#
			16pF	±5%	GQM1875G2E160JB12#
				±2%	GQM1875G2E180GB12#
			18pF	±5%	GQM1875G2E180JB12#
				±2%	GQM1875G2E200GB12#
			20pF	±5%	GQM1875G2E200JB12#
				±2%	GQM1875G2E220GB12#
			22pF	±5%	GQM1875G2E220JB12#
				±2%	GQM1875G2E240GB12#
			24pF	±5%	GQM1875G2E240JB12#
				±2%	GQM1875G2E270GB12#
27pF	±5%	GQM1875G2E270JB12#			
	±2%	GQM1875G2E300GB12#			
30pF	±5%	GQM1875G2E300JB12#			

2.0×1.25mm

T max.	Rated Voltage	TC Code	Cap.	Tol.	Part Number
1.0mm	500Vdc	X8G	1.0pF	±0.1pF	GQM2195G2H1R0BB12#
				±0.25pF	GQM2195G2H1R0CB12#
			1.1pF	±0.1pF	GQM2195G2H1R1BB12#
				±0.25pF	GQM2195G2H1R1CB12#
			1.2pF	±0.1pF	GQM2195G2H1R2BB12#
				±0.25pF	GQM2195G2H1R2CB12#
			1.3pF	±0.1pF	GQM2195G2H1R3BB12#
				±0.25pF	GQM2195G2H1R3CB12#
			1.5pF	±0.1pF	GQM2195G2H1R5BB12#
				±0.25pF	GQM2195G2H1R5CB12#
			1.6pF	±0.1pF	GQM2195G2H1R6BB12#
				±0.25pF	GQM2195G2H1R6CB12#
			1.8pF	±0.1pF	GQM2195G2H1R8BB12#
				±0.25pF	GQM2195G2H1R8CB12#
			2.0pF	±0.1pF	GQM2195G2H2R0BB12#
				±0.25pF	GQM2195G2H2R0CB12#
			2.2pF	±0.1pF	GQM2195G2H2R2BB12#
				±0.25pF	GQM2195G2H2R2CB12#
			2.4pF	±0.1pF	GQM2195G2H2R4BB12#
				±0.25pF	GQM2195G2H2R4CB12#
			2.7pF	±0.1pF	GQM2195G2H2R7BB12#
				±0.25pF	GQM2195G2H2R7CB12#

Part number # indicates the package specification code.

GRM
 GR3
 GRJ
 GR4
 GJM
 GQM
 GA2
 GA3 GB
 GA3 GD
 GA3 GF
 LLL
 LLA
 LLM
 LLR
 NFM
 KRM
 KR3
 GMA
 GMD
 ⚠Caution /Notice

GQM Series Temperature Compensating Type High Q Part Number List

(→ 2.0×1.25mm)

T max.	Rated Voltage	TC Code	Cap.	Tol.	Part Number	T max.	Rated Voltage	TC Code	Cap.	Tol.	Part Number		
1.0mm	500Vdc	X8G	3.0pF	±0.1pF	GQM2195G2H3R0BB12#	1.0mm	500Vdc	X8G	22pF	±2%	GQM2195G2H220GB12#		
				±0.25pF	GQM2195G2H3R0CB12#					±5%	GQM2195G2H220JB12#		
			3.3pF	±0.1pF	GQM2195G2H3R3BB12#				250Vdc	COG	1.0pF	±0.1pF	GQM2195C2E1R0BB12#
				±0.25pF	GQM2195G2H3R3CB12#							±0.25pF	GQM2195C2E1R0CB12#
			3.6pF	±0.1pF	GQM2195G2H3R6BB12#						1.1pF	±0.1pF	GQM2195C2E1R1BB12#
				±0.25pF	GQM2195G2H3R6CB12#							±0.25pF	GQM2195C2E1R1CB12#
			3.9pF	±0.1pF	GQM2195G2H3R9BB12#						1.2pF	±0.1pF	GQM2195C2E1R2BB12#
				±0.25pF	GQM2195G2H3R9CB12#							±0.25pF	GQM2195C2E1R2CB12#
			4.0pF	±0.1pF	GQM2195G2H4R0BB12#						1.3pF	±0.1pF	GQM2195C2E1R3BB12#
				±0.25pF	GQM2195G2H4R0CB12#							±0.25pF	GQM2195C2E1R3CB12#
			4.3pF	±0.1pF	GQM2195G2H4R3BB12#						1.5pF	±0.1pF	GQM2195C2E1R5BB12#
				±0.25pF	GQM2195G2H4R3CB12#							±0.25pF	GQM2195C2E1R5CB12#
			4.7pF	±0.1pF	GQM2195G2H4R7BB12#						1.6pF	±0.1pF	GQM2195C2E1R6BB12#
				±0.25pF	GQM2195G2H4R7CB12#							±0.25pF	GQM2195C2E1R6CB12#
			5.0pF	±0.1pF	GQM2195G2H5R0BB12#						1.8pF	±0.1pF	GQM2195C2E1R8BB12#
				±0.25pF	GQM2195G2H5R0CB12#							±0.25pF	GQM2195C2E1R8CB12#
			5.1pF	±0.25pF	GQM2195G2H5R1CB12#						2.0pF	±0.1pF	GQM2195C2E2R0BB12#
				±0.5pF	GQM2195G2H5R1DB12#							±0.25pF	GQM2195C2E2R0CB12#
			5.6pF	±0.25pF	GQM2195G2H5R6CB12#						2.2pF	±0.1pF	GQM2195C2E2R2BB12#
				±0.5pF	GQM2195G2H5R6DB12#							±0.25pF	GQM2195C2E2R2CB12#
			6.0pF	±0.25pF	GQM2195G2H6R0CB12#						2.4pF	±0.1pF	GQM2195C2E2R4BB12#
				±0.5pF	GQM2195G2H6R0DB12#							±0.25pF	GQM2195C2E2R4CB12#
			6.2pF	±0.25pF	GQM2195G2H6R2CB12#						2.7pF	±0.1pF	GQM2195C2E2R7BB12#
				±0.5pF	GQM2195G2H6R2DB12#							±0.25pF	GQM2195C2E2R7CB12#
			6.8pF	±0.25pF	GQM2195G2H6R8CB12#						3.0pF	±0.1pF	GQM2195C2E3R0BB12#
				±0.5pF	GQM2195G2H6R8DB12#							±0.25pF	GQM2195C2E3R0CB12#
			7.0pF	±0.25pF	GQM2195G2H7R0CB12#						3.3pF	±0.1pF	GQM2195C2E3R3BB12#
				±0.5pF	GQM2195G2H7R0DB12#							±0.25pF	GQM2195C2E3R3CB12#
			7.5pF	±0.25pF	GQM2195G2H7R5CB12#						3.6pF	±0.1pF	GQM2195C2E3R6BB12#
				±0.5pF	GQM2195G2H7R5DB12#							±0.25pF	GQM2195C2E3R6CB12#
			8.0pF	±0.25pF	GQM2195G2H8R0CB12#						3.9pF	±0.1pF	GQM2195C2E3R9BB12#
				±0.5pF	GQM2195G2H8R0DB12#							±0.25pF	GQM2195C2E3R9CB12#
			8.2pF	±0.25pF	GQM2195G2H8R2CB12#						4.0pF	±0.1pF	GQM2195C2E4R0BB12#
				±0.5pF	GQM2195G2H8R2DB12#							±0.25pF	GQM2195C2E4R0CB12#
			9.0pF	±0.25pF	GQM2195G2H9R0CB12#						4.3pF	±0.1pF	GQM2195C2E4R3BB12#
				±0.5pF	GQM2195G2H9R0DB12#							±0.25pF	GQM2195C2E4R3CB12#
			9.1pF	±0.25pF	GQM2195G2H9R1CB12#						4.7pF	±0.1pF	GQM2195C2E4R7BB12#
				±0.5pF	GQM2195G2H9R1DB12#							±0.25pF	GQM2195C2E4R7CB12#
			10pF	±2%	GQM2195G2H100GB12#						5.0pF	±0.1pF	GQM2195C2E5R0BB12#
				±5%	GQM2195G2H100JB12#							±0.25pF	GQM2195C2E5R0CB12#
			11pF	±2%	GQM2195G2H110GB12#						5.1pF	±0.25pF	GQM2195C2E5R1CB12#
				±5%	GQM2195G2H110JB12#							±0.5pF	GQM2195C2E5R1DB12#
			12pF	±2%	GQM2195G2H120GB12#						5.6pF	±0.25pF	GQM2195C2E5R6CB12#
				±5%	GQM2195G2H120JB12#							±0.5pF	GQM2195C2E5R6DB12#
			13pF	±2%	GQM2195G2H130GB12#						6.0pF	±0.25pF	GQM2195C2E6R0CB12#
				±5%	GQM2195G2H130JB12#							±0.5pF	GQM2195C2E6R0DB12#
			15pF	±2%	GQM2195G2H150GB12#						6.2pF	±0.25pF	GQM2195C2E6R2CB12#
				±5%	GQM2195G2H150JB12#							±0.5pF	GQM2195C2E6R2DB12#
16pF	±2%	GQM2195G2H160GB12#	6.8pF	±0.25pF	GQM2195C2E6R8CB12#								
	±5%	GQM2195G2H160JB12#		±0.5pF	GQM2195C2E6R8DB12#								
18pF	±2%	GQM2195G2H180GB12#	7.0pF	±0.25pF	GQM2195C2E7R0CB12#								
	±5%	GQM2195G2H180JB12#		±0.5pF	GQM2195C2E7R0DB12#								
20pF	±2%	GQM2195G2H200GB12#	7.5pF	±0.25pF	GQM2195C2E7R5CB12#								
	±5%	GQM2195G2H200JB12#		±0.5pF	GQM2195C2E7R5DB12#								

- GRM
- GR3
- GRJ
- GR4
- GJM
- GQM**
- GA2
- GA3 GB
- GA3 GD
- GA3 GF
- LLL
- LLA
- LLM
- LLR
- NFM
- KRM
- KR3
- GMA
- GMD
- ⚠Caution /Notice

Part number # indicates the package specification code.

GQM Series Temperature Compensating Type High Q Part Number List

(→ 2.0×1.25mm)

T max.	Rated Voltage	TC Code	Cap.	Tol.	Part Number
1.0mm	250Vdc	COG	8.0pF	±0.25pF	GQM2195C2E8R0CB12#
				±0.5pF	GQM2195C2E8R0DB12#
			8.2pF	±0.25pF	GQM2195C2E8R2CB12#
				±0.5pF	GQM2195C2E8R2DB12#
			9.0pF	±0.25pF	GQM2195C2E9R0CB12#
				±0.5pF	GQM2195C2E9R0DB12#
			9.1pF	±0.25pF	GQM2195C2E9R1CB12#
				±0.5pF	GQM2195C2E9R1DB12#
			10pF	±2%	GQM2195C2E100GB12#
				±5%	GQM2195C2E100JB12#
			11pF	±2%	GQM2195C2E110GB12#
				±5%	GQM2195C2E110JB12#
			12pF	±2%	GQM2195C2E120GB12#
				±5%	GQM2195C2E120JB12#
			13pF	±2%	GQM2195C2E130GB12#
				±5%	GQM2195C2E130JB12#
			15pF	±2%	GQM2195C2E150GB12#
				±5%	GQM2195C2E150JB12#
			16pF	±2%	GQM2195C2E160GB12#
				±5%	GQM2195C2E160JB12#
			18pF	±2%	GQM2195C2E180GB12#
				±5%	GQM2195C2E180JB12#
			20pF	±2%	GQM2195C2E200GB12#
				±5%	GQM2195C2E200JB12#
			22pF	±2%	GQM2195C2E220GB12#
				±5%	GQM2195C2E220JB12#
			24pF	±2%	GQM2195C2E240GB12#
				±5%	GQM2195C2E240JB12#
			27pF	±2%	GQM2195C2E270GB12#
				±5%	GQM2195C2E270JB12#
			30pF	±2%	GQM2195C2E300GB12#
				±5%	GQM2195C2E300JB12#
			33pF	±2%	GQM2195C2E330GB12#
				±5%	GQM2195C2E330JB12#
			36pF	±2%	GQM2195C2E360GB12#
				±5%	GQM2195C2E360JB12#
			39pF	±2%	GQM2195C2E390GB12#
				±5%	GQM2195C2E390JB12#
			43pF	±2%	GQM2195C2E430GB12#
				±5%	GQM2195C2E430JB12#
			47pF	±2%	GQM2195C2E470GB12#
				±5%	GQM2195C2E470JB12#
			51pF	±2%	GQM2195C2E510GB12#
				±5%	GQM2195C2E510JB12#
			56pF	±2%	GQM2195C2E560GB12#
				±5%	GQM2195C2E560JB12#
			62pF	±2%	GQM2195C2E620GB12#
				±5%	GQM2195C2E620JB12#
			68pF	±2%	GQM2195C2E680GB12#
				±5%	GQM2195C2E680JB12#
			75pF	±2%	GQM2195C2E750GB12#
				±5%	GQM2195C2E750JB12#
82pF	±2%	GQM2195C2E820GB12#			
	±5%	GQM2195C2E820JB12#			

T max.	Rated Voltage	TC Code	Cap.	Tol.	Part Number	
1.0mm	250Vdc	COG	91pF	±2%	GQM2195C2E910GB12#	
				±5%	GQM2195C2E910JB12#	
			100pF	±2%	GQM2195C2E101GB12#	
				±5%	GQM2195C2E101JB12#	
			X8G	1.0pF	±0.1pF	GQM2195G2E1R0BB12#
					±0.25pF	GQM2195G2E1R0CB12#
			1.1pF	±0.1pF	GQM2195G2E1R1BB12#	
				±0.25pF	GQM2195G2E1R1CB12#	
			1.2pF	±0.1pF	GQM2195G2E1R2BB12#	
				±0.25pF	GQM2195G2E1R2CB12#	
			1.3pF	±0.1pF	GQM2195G2E1R3BB12#	
				±0.25pF	GQM2195G2E1R3CB12#	
			1.5pF	±0.1pF	GQM2195G2E1R5BB12#	
				±0.25pF	GQM2195G2E1R5CB12#	
			1.6pF	±0.1pF	GQM2195G2E1R6BB12#	
				±0.25pF	GQM2195G2E1R6CB12#	
			1.8pF	±0.1pF	GQM2195G2E1R8BB12#	
				±0.25pF	GQM2195G2E1R8CB12#	
			2.0pF	±0.1pF	GQM2195G2E2R0BB12#	
				±0.25pF	GQM2195G2E2R0CB12#	
			2.2pF	±0.1pF	GQM2195G2E2R2BB12#	
				±0.25pF	GQM2195G2E2R2CB12#	
			2.4pF	±0.1pF	GQM2195G2E2R4BB12#	
				±0.25pF	GQM2195G2E2R4CB12#	
			2.7pF	±0.1pF	GQM2195G2E2R7BB12#	
				±0.25pF	GQM2195G2E2R7CB12#	
			3.0pF	±0.1pF	GQM2195G2E3R0BB12#	
				±0.25pF	GQM2195G2E3R0CB12#	
			3.3pF	±0.1pF	GQM2195G2E3R3BB12#	
				±0.25pF	GQM2195G2E3R3CB12#	
			3.6pF	±0.1pF	GQM2195G2E3R6BB12#	
				±0.25pF	GQM2195G2E3R6CB12#	
			3.9pF	±0.1pF	GQM2195G2E3R9BB12#	
				±0.25pF	GQM2195G2E3R9CB12#	
			4.0pF	±0.1pF	GQM2195G2E4R0BB12#	
				±0.25pF	GQM2195G2E4R0CB12#	
			4.3pF	±0.1pF	GQM2195G2E4R3BB12#	
				±0.25pF	GQM2195G2E4R3CB12#	
			4.7pF	±0.1pF	GQM2195G2E4R7BB12#	
				±0.25pF	GQM2195G2E4R7CB12#	
			5.0pF	±0.1pF	GQM2195G2E5R0BB12#	
				±0.25pF	GQM2195G2E5R0CB12#	
5.1pF	±0.25pF	GQM2195G2E5R1CB12#				
	±0.5pF	GQM2195G2E5R1DB12#				
5.6pF	±0.25pF	GQM2195G2E5R6CB12#				
	±0.5pF	GQM2195G2E5R6DB12#				
6.0pF	±0.25pF	GQM2195G2E6R0CB12#				
	±0.5pF	GQM2195G2E6R0DB12#				
6.2pF	±0.25pF	GQM2195G2E6R2CB12#				
	±0.5pF	GQM2195G2E6R2DB12#				
6.8pF	±0.25pF	GQM2195G2E6R8CB12#				
	±0.5pF	GQM2195G2E6R8DB12#				
7.0pF	±0.25pF	GQM2195G2E7R0CB12#				
	±0.5pF	GQM2195G2E7R0DB12#				

GRM
 GR3
 GRJ
 GR4
 GJM
GQM
 GA2
 GA3 GB
 GA3 GD
 GA3 GF
 LLL
 LLA
 LLM
 LLR
 NFM
 KRM
 KR3
 GMA
 GMD
 ⚠Caution /Notice

Part number # indicates the package specification code.

GQM Series Temperature Compensating Type High Q Part Number List

(→ 2.0×1.25mm)

T max.	Rated Voltage	TC Code	Cap.	Tol.	Part Number
1.0mm	250Vdc	X8G	7.5pF	±0.25pF	GQM2195G2E7R5CB12#
				±0.5pF	GQM2195G2E7R5DB12#
			8.0pF	±0.25pF	GQM2195G2E8ROCB12#
				±0.5pF	GQM2195G2E8RODB12#
			8.2pF	±0.25pF	GQM2195G2E8R2CB12#
				±0.5pF	GQM2195G2E8R2DB12#
			9.0pF	±0.25pF	GQM2195G2E9ROCB12#
				±0.5pF	GQM2195G2E9RODB12#
			9.1pF	±0.25pF	GQM2195G2E9R1CB12#
				±0.5pF	GQM2195G2E9R1DB12#
			10pF	±2%	GQM2195G2E100GB12#
				±5%	GQM2195G2E100JB12#
			11pF	±2%	GQM2195G2E110GB12#
				±5%	GQM2195G2E110JB12#
			12pF	±2%	GQM2195G2E120GB12#
				±5%	GQM2195G2E120JB12#
			13pF	±2%	GQM2195G2E130GB12#
				±5%	GQM2195G2E130JB12#
			15pF	±2%	GQM2195G2E150GB12#
				±5%	GQM2195G2E150JB12#
			16pF	±2%	GQM2195G2E160GB12#
				±5%	GQM2195G2E160JB12#
			18pF	±2%	GQM2195G2E180GB12#
				±5%	GQM2195G2E180JB12#
			20pF	±2%	GQM2195G2E200GB12#
				±5%	GQM2195G2E200JB12#
			22pF	±2%	GQM2195G2E220GB12#
				±5%	GQM2195G2E220JB12#
			24pF	±2%	GQM2195G2E240GB12#
				±5%	GQM2195G2E240JB12#
			27pF	±2%	GQM2195G2E270GB12#
				±5%	GQM2195G2E270JB12#
			30pF	±2%	GQM2195G2E300GB12#
				±5%	GQM2195G2E300JB12#
			33pF	±2%	GQM2195G2E330GB12#
				±5%	GQM2195G2E330JB12#
			36pF	±2%	GQM2195G2E360GB12#
				±5%	GQM2195G2E360JB12#
			39pF	±2%	GQM2195G2E390GB12#
				±5%	GQM2195G2E390JB12#
			43pF	±2%	GQM2195G2E430GB12#
				±5%	GQM2195G2E430JB12#
			47pF	±2%	GQM2195G2E470GB12#
				±5%	GQM2195G2E470JB12#
			51pF	±2%	GQM2195G2E510GB12#
				±5%	GQM2195G2E510JB12#
			56pF	±2%	GQM2195G2E560GB12#
				±5%	GQM2195G2E560JB12#
			62pF	±2%	GQM2195G2E620GB12#
				±5%	GQM2195G2E620JB12#
			68pF	±2%	GQM2195G2E680GB12#
				±5%	GQM2195G2E680JB12#
			75pF	±2%	GQM2195G2E750GB12#
				±5%	GQM2195G2E750JB12#

T max.	Rated Voltage	TC Code	Cap.	Tol.	Part Number
1.0mm	250Vdc	X8G	82pF	±2%	GQM2195G2E820GB12#
				±5%	GQM2195G2E820JB12#

2.8×2.8mm

T max.	Rated Voltage	TC Code	Cap.	Tol.	Part Number
1.35mm	500Vdc	COG	1.0pF	±0.1pF	GQM22M5C2H1R0BB01#
				±0.25pF	GQM22M5C2H1R0CB01#
			1.1pF	±0.1pF	GQM22M5C2H1R1BB01#
				±0.25pF	GQM22M5C2H1R1CB01#
			1.2pF	±0.1pF	GQM22M5C2H1R2BB01#
				±0.25pF	GQM22M5C2H1R2CB01#
			1.3pF	±0.1pF	GQM22M5C2H1R3BB01#
				±0.25pF	GQM22M5C2H1R3CB01#
			1.5pF	±0.1pF	GQM22M5C2H1R5BB01#
				±0.25pF	GQM22M5C2H1R5CB01#
			1.6pF	±0.1pF	GQM22M5C2H1R6BB01#
				±0.25pF	GQM22M5C2H1R6CB01#
			1.8pF	±0.1pF	GQM22M5C2H1R8BB01#
				±0.25pF	GQM22M5C2H1R8CB01#
			2.0pF	±0.1pF	GQM22M5C2H2R0BB01#
				±0.25pF	GQM22M5C2H2R0CB01#
			2.2pF	±0.1pF	GQM22M5C2H2R2BB01#
				±0.25pF	GQM22M5C2H2R2CB01#
			2.4pF	±0.1pF	GQM22M5C2H2R4BB01#
				±0.25pF	GQM22M5C2H2R4CB01#
			2.7pF	±0.1pF	GQM22M5C2H2R7BB01#
				±0.25pF	GQM22M5C2H2R7CB01#
			3.0pF	±0.1pF	GQM22M5C2H3R0BB01#
				±0.25pF	GQM22M5C2H3R0CB01#
			3.3pF	±0.1pF	GQM22M5C2H3R3BB01#
				±0.25pF	GQM22M5C2H3R3CB01#
			3.6pF	±0.1pF	GQM22M5C2H3R6BB01#
				±0.25pF	GQM22M5C2H3R6CB01#
			3.9pF	±0.1pF	GQM22M5C2H3R9BB01#
				±0.25pF	GQM22M5C2H3R9CB01#
			4.0pF	±0.1pF	GQM22M5C2H4R0BB01#
				±0.25pF	GQM22M5C2H4R0CB01#
			4.3pF	±0.1pF	GQM22M5C2H4R3BB01#
				±0.25pF	GQM22M5C2H4R3CB01#
			4.7pF	±0.1pF	GQM22M5C2H4R7BB01#
				±0.25pF	GQM22M5C2H4R7CB01#
			5.0pF	±0.1pF	GQM22M5C2H5R0BB01#
				±0.25pF	GQM22M5C2H5R0CB01#
			5.1pF	±0.25pF	GQM22M5C2H5R1CB01#
				±0.5pF	GQM22M5C2H5R1DB01#
			5.6pF	±0.25pF	GQM22M5C2H5R6CB01#
				±0.5pF	GQM22M5C2H5R6DB01#
6.0pF	±0.25pF	GQM22M5C2H6R0CB01#			
	±0.5pF	GQM22M5C2H6R0DB01#			
6.2pF	±0.25pF	GQM22M5C2H6R2CB01#			
	±0.5pF	GQM22M5C2H6R2DB01#			
6.8pF	±0.25pF	GQM22M5C2H6R8CB01#			

Part number # indicates the package specification code.

GRM
 GR3
 GRJ
 GR4
 GJM
 GJM
 GQM
 GA2
 GA3
 GB
 GA3
 GD
 GA3
 GF
 GLL
 LLL
 LLA
 LLM
 LLM
 LLR
 NFM
 KRM
 KR3
 GMA
 GMD
 ⚠Caution / Notice

GQM Series Temperature Compensating Type High Q Part Number List

(→ 2.8×2.8mm)

T max.	Rated Voltage	TC Code	Cap.	Tol.	Part Number
1.35mm	500Vdc	COG	6.8pF	±0.5pF	GQM22M5C2H6R8DB01#
				±0.25pF	GQM22M5C2H7R0CB01#
			7.0pF	±0.5pF	GQM22M5C2H7R0DB01#
				±0.25pF	GQM22M5C2H7R5CB01#
			7.5pF	±0.5pF	GQM22M5C2H7R5DB01#
				±0.25pF	GQM22M5C2H8R0CB01#
			8.0pF	±0.5pF	GQM22M5C2H8R0DB01#
				±0.25pF	GQM22M5C2H8R2CB01#
			8.2pF	±0.5pF	GQM22M5C2H8R2DB01#
				±0.25pF	GQM22M5C2H9R0CB01#
			9.0pF	±0.5pF	GQM22M5C2H9R0DB01#
				±0.25pF	GQM22M5C2H9R1CB01#
			9.1pF	±0.5pF	GQM22M5C2H9R1DB01#
				±2%	GQM22M5C2H100GB01#
			10pF	±5%	GQM22M5C2H100JB01#
				±2%	GQM22M5C2H110GB01#
			11pF	±5%	GQM22M5C2H110JB01#
				±2%	GQM22M5C2H120GB01#
			12pF	±5%	GQM22M5C2H120JB01#
				±2%	GQM22M5C2H130GB01#
			13pF	±5%	GQM22M5C2H130JB01#
				±2%	GQM22M5C2H150GB01#
			15pF	±5%	GQM22M5C2H150JB01#
				±2%	GQM22M5C2H160GB01#
			16pF	±5%	GQM22M5C2H160JB01#
				±2%	GQM22M5C2H180GB01#
			18pF	±5%	GQM22M5C2H180JB01#
				±2%	GQM22M5C2H200GB01#
			20pF	±5%	GQM22M5C2H200JB01#
				±2%	GQM22M5C2H220GB01#
			22pF	±5%	GQM22M5C2H220JB01#
				±2%	GQM22M5C2H240GB01#
			24pF	±5%	GQM22M5C2H240JB01#
				±2%	GQM22M5C2H270GB01#
			27pF	±5%	GQM22M5C2H270JB01#
				±2%	GQM22M5C2H300GB01#
			30pF	±5%	GQM22M5C2H300JB01#
				±2%	GQM22M5C2H330GB01#
			33pF	±5%	GQM22M5C2H330JB01#
				±2%	GQM22M5C2H360GB01#
			36pF	±5%	GQM22M5C2H360JB01#
				±2%	GQM22M5C2H390GB01#
			39pF	±5%	GQM22M5C2H390JB01#
				±2%	GQM22M5C2H430GB01#
			43pF	±5%	GQM22M5C2H430JB01#
				±2%	GQM22M5C2H470GB01#
			47pF	±5%	GQM22M5C2H470JB01#
				±2%	GQM22M5C2H510GB01#
51pF	±5%	GQM22M5C2H510JB01#			
	±2%	GQM22M5C2H560GB01#			
56pF	±5%	GQM22M5C2H560JB01#			
	±2%	GQM22M5C2H620GB01#			
62pF	±5%	GQM22M5C2H620JB01#			
	±2%	GQM22M5C2H680GB01#			

T max.	Rated Voltage	TC Code	Cap.	Tol.	Part Number
1.35mm	500Vdc	COG	68pF	±5%	GQM22M5C2H680JB01#
				±2%	GQM22M5C2H750GB01#
			75pF	±5%	GQM22M5C2H750JB01#
				±2%	GQM22M5C2H820GB01#
			82pF	±5%	GQM22M5C2H820JB01#
				±2%	GQM22M5C2H910GB01#
			91pF	±5%	GQM22M5C2H910JB01#
				±2%	GQM22M5C2H101GB01#
			100pF	±5%	GQM22M5C2H101JB01#

Part number # indicates the package specification code.

GRM
 GR3
 GRJ
 GR4
 GJM
 GQM
 GA2
 GA3 GB
 GA3 GD
 GA3 GF
 LLL
 LLA
 LLM
 LLR
 NFM
 KRM
 KR3
 GMA
 GMD
 ⚠Caution /Notice

Based on the Electrical Appliance and Material Safety Law of Japan Chip Multilayer Ceramic Capacitors for General Purpose

GA2 Series



This product is for commercial power supplies, compliant with the Electrical Appliance and Material Safety Law of Japan.

Features

- 1 Sn plating is applied to the external electrodes, providing excellent solderability.

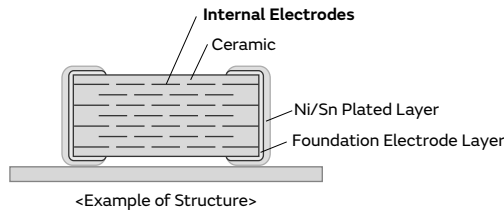

- 2 Realized large capacitance value and small size while maintaining high withstand voltages by the multilayer structure.
- 3 This product is only for reflow soldering.
- 4 There are types for connections between lines and connections between lines and ground.

Specifications

Size (mm)	4.5×2.0mm to 5.7×5.0mm
Rated Voltage	250Vac(r.m.s.)
Capacitance	470pF to 0.10μF
Main Applications	General purpose for Japan

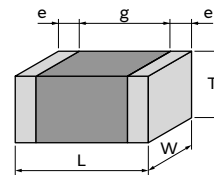

<Dimensions>

This catalog contains only a portion of the product lineup.
 Please refer to the capacitor search tool on the Murata Web site for details.

- GRM
- GR3
- GRJ
- GR4
- GJM
- GQM
- GA2**
- GA3 GB
- GA3 GD
- GA3 GF
- LLL
- LLA
- LLM
- LLR
- NFM
- KRM
- KR3
- GMA
- GMD
- ⚠Caution / Notice

GA2 Series High Dielectric Constant Type Part Number List

4.5×2.0mm

T max.	Rated Voltage	TC Code	Cap.	Tol.	Part Number
1.5mm	250Vac(r.m.s.)	X7R	470pF	±20%	GA242QR7E2471MW01#
			1000pF	±20%	GA242QR7E2102MW01#

4.5×3.2mm

T max.	Rated Voltage	TC Code	Cap.	Tol.	Part Number
1.5mm	250Vac(r.m.s.)	X7R	2200pF	±20%	GA243QR7E2222MW01#
			3300pF	±20%	GA243QR7E2332MW01#
			10000pF	±20%	GA243QR7E2103MW01#
			22000pF	±20%	GA243QR7E2223MW01#
2.0mm	250Vac(r.m.s.)	X7R	4700pF	±20%	GA243DR7E2472MW01#
			47000pF	±20%	GA243DR7E2473MW01#

5.7×5.0mm

T max.	Rated Voltage	TC Code	Cap.	Tol.	Part Number
2.0mm	250Vac(r.m.s.)	X7R	0.10μF	±20%	GA255DR7E2104MW01#

- GRM
- GR3
- GRJ
- GR4
- GJM
- GQM
- GA2**
- GA3 GB
- GA3 GD
- GA3 GF
- LLL
- LLA
- LLM
- LLR
- NFM
- KRM
- KR3
- GMA
- GMD
- ⚠Caution /Notice

Part number # indicates the package specification code.

Safety Standard Certified Chip Multilayer Ceramic Capacitors for General Purpose / IEC60384-14 Class X2

GA3 Series Type GB



IEC60384-14 X2 Class Certified Product

Features

① IEC60384-14 X2 Class Certified product.

Please down load Safety Standard Certification (Type GB: X2) from here.



② Can be used as a Class X2 capacitor.

● Switching Power Supply - Class 1 Equipment

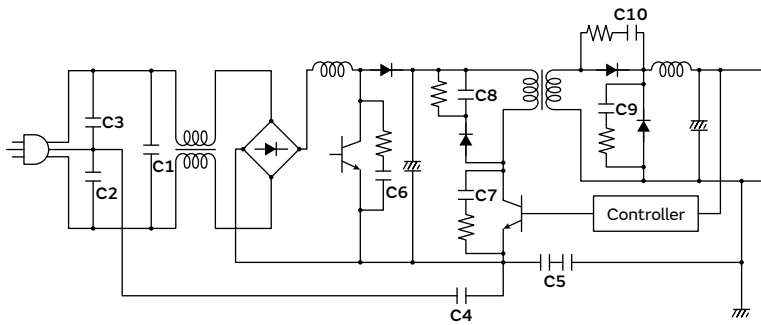

No.	Application	Recommend MLCC Type
C1	X Cap	Type: GB
C2	Y Cap	Type: GF
C3		
C4		
C5	Primary - Secondary Coupling	Type: GF×2

● Switching Power Supply - Class 2 Equipment

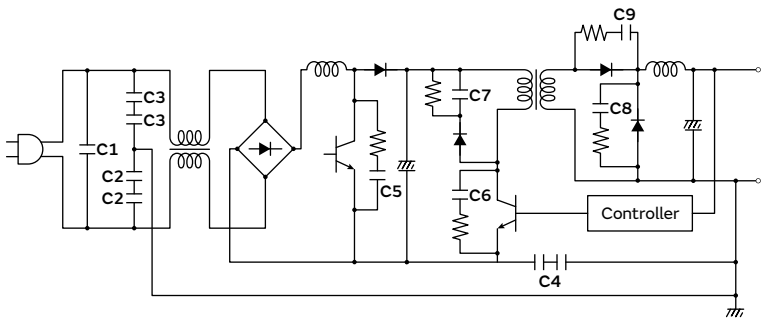

No.	Application	Recommend MLCC Type
C1	X Cap	Type: GB
C2	Y Cap	Type: GF×2
C3		
C4	Primary - Secondary Coupling	

- GRM
- GR3
- GRJ
- GR4
- GJM
- GQM
- GA2
- GA3 GB
- GA3 GD
- GA3 GF
- LLL
- LLA
- LLM
- LLR
- NFM
- KRM
- KR3
- GMA
- GMD
- △Caution / Notice

- ③ Realized large capacitance value and small size while maintaining high withstand voltages by the multilayer structure.

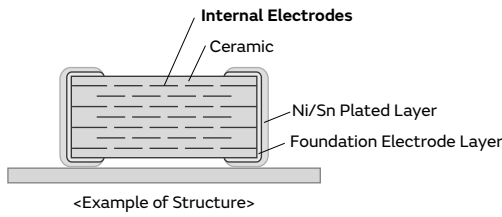

- ④ Compared with conventional lead type capacitors, this product realized great reductions in size and height, with a volume of 1/10 or less, and height of 1/4 or less.

- ⑤ This product is only for reflow soldering.

Specifications

Size (mm)	5.7×5.0mm
Rated Voltage	250Vac(r.m.s.)
Capacitance	10000pF to 56000pF
Main Applications	AC-DC power supply

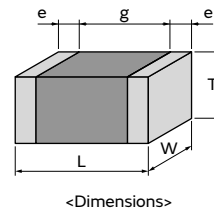

This catalog contains only a portion of the product lineup.
 Please refer to the capacitor search tool on the Murata Web site for details.

- GRM
- GR3
- GRJ
- GR4
- GJM
- GQM
- GA2
- GA3 GB
- GA3 GD
- GA3 GF
- LLL
- LLA
- LLM
- LLR
- NFM
- KRM
- KR3
- GMA
- GMD
- ⚠Caution /Notice

GA3 Series Type GB High Dielectric Constant Type Part Number List

5.7×5.0mm

T max.	Rated Voltage	TC Code	Cap.	Tol.	Part Number
1.5mm	250Vac(r.m.s.)	X7R	10000pF	±10%	GA355QR7GB103KW01#
			15000pF	±10%	GA355QR7GB153KW01#
2.0mm	250Vac(r.m.s.)	X7R	22000pF	±10%	GA355DR7GB223KW01#
2.5mm	250Vac(r.m.s.)	X7R	33000pF	±10%	GA355ER7GB333KW01#
			47000pF	±10%	GA355ER7GB473KW01#
2.9mm	250Vac(r.m.s.)	X7R	56000pF	±10%	GA355XR7GB563KW06#

- GRM
- GR3
- GRJ
- GR4
- GJM
- GQM
- GA2
- GA3 GB**
- GA3 GD
- GA3 GF
- LLL
- LLA
- LLM
- LLR
- NFM
- KRM
- KR3
- GMA
- GMD
- ⚠Caution /Notice

Part number # indicates the package specification code.

Safety Standard Certified Chip Multilayer Ceramic Capacitors for General Purpose / Acquired Certifications of UL60950-1

GA3 Series Type GD



UL60950-1 Certified Product

Features

- 1 **UL60950-1 certified product.**

Please download Safety Standard Certification (Type GD) from here.



- 2 **Can be used for UL60950-1 devices.**

● DAA Modem - Transformer Less

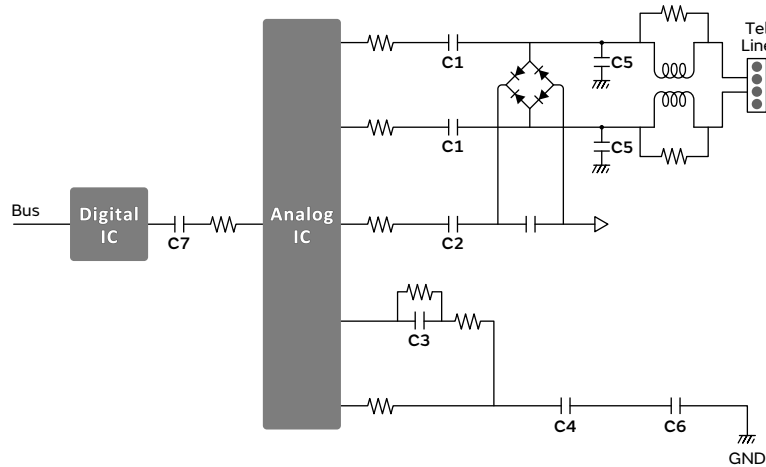

No.	Application	Recommend MLCC Type
C5	Lighting Surge Absorption	Type: GD / GF
C6	Noise Immunity	
C7	D/A Isolation Barrier	

- 3 **Realized large capacitance value and small size while maintaining high withstand voltages by the multilayer structure.**

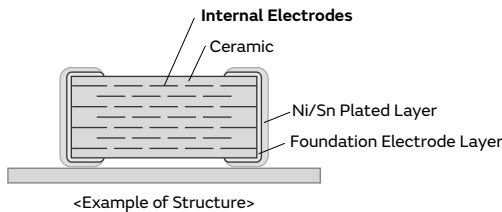

- 4 **This product is only for reflow soldering.**

Specifications

Size (mm)	4.5×2.0mm to 4.5×3.2mm
Rated Voltage	250Vac(r.m.s.)
Capacitance	10pF to 4700pF
Main Applications	Modem

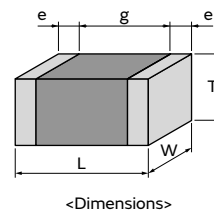

This catalog contains only a portion of the product lineup.
 Please refer to the capacitor search tool on the Murata Web site for details.

GRM
 GR3
 GRJ
 GR4
 GJM
 GQM
 GA2
 GA3 GB
 GA3 GD
 GA3 GF
 LLL
 LLA
 LLM
 LLR
 NFM
 KRM
 KR3
 GMA
 GMD
 ⚠Caution / Notice

GA3 Series Type GD Temperature Compensating Type Part Number List

4.5×2.0mm

T max.	Rated Voltage	TC Code	Cap.	Tol.	Part Number
1.0mm	250Vac(r.m.s.)	SL	10pF	±5%	GA342A1XGD100JW31#
			12pF	±5%	GA342A1XGD120JW31#
			15pF	±5%	GA342A1XGD150JW31#
			18pF	±5%	GA342A1XGD180JW31#
			22pF	±5%	GA342A1XGD220JW31#
			27pF	±5%	GA342A1XGD270JW31#
			33pF	±5%	GA342A1XGD330JW31#
			39pF	±5%	GA342A1XGD390JW31#
			47pF	±5%	GA342A1XGD470JW31#
			56pF	±5%	GA342A1XGD560JW31#
			68pF	±5%	GA342A1XGD680JW31#
			82pF	±5%	GA342A1XGD820JW31#

- GRM
- GR3
- GRJ
- GR4
- GJM
- GQM
- GA2
- GA3 GB
- GA3 GD
- GA3 GF
- LLL
- LLA
- LLM
- LLR
- NFM
- KRM
- KR3
- GMA
- GMD
- ⚠Caution /Notice

Part number # indicates the package specification code.

GA3 Series Type GD High Dielectric Constant Type Part Number List

4.5×2.0mm

T max.	Rated Voltage	TC Code	Cap.	Tol.	Part Number
1.5mm	250Vac(r.m.s.)	X7R	100pF	±10%	GA342QR7GD101KW01#
			150pF	±10%	GA342QR7GD151KW01#
			220pF	±10%	GA342QR7GD221KW01#
			330pF	±10%	GA342QR7GD331KW01#
			470pF	±10%	GA342QR7GD471KW01#
			680pF	±10%	GA342QR7GD681KW01#
			1000pF	±10%	GA342QR7GD102KW01#
			1500pF	±10%	GA342QR7GD152KW01#

4.5×3.2mm

T max.	Rated Voltage	TC Code	Cap.	Tol.	Part Number
1.5mm	250Vac(r.m.s.)	X7R	1800pF	±10%	GA343QR7GD182KW01#
			2200pF	±10%	GA343QR7GD222KW01#
2.0mm	250Vac(r.m.s.)	X7R	4700pF	±10%	GA343DR7GD472KW01#

- GRM
- GR3
- GRJ
- GR4
- GJM
- GQM
- GA2
- GA3 GB
- GA3 GD
- GA3 GF
- LLL
- LLA
- LLM
- LLR
- NFM
- KRM
- KR3
- GMA
- GMD
- ⚠Caution /Notice

Part number # indicates the package specification code.

Safety Standard Certified Chip Multilayer Ceramic Capacitors for General Purpose / Acquired Certifications of IEC60384-14 Class X1/Y2 and UL60950-1

GA3 Series Type GF



Size 4.5x2.0mm: This product is applicable only for the instruments certified by EN/IEC60950-1
Size 5.7x2.8mm or 5.7x5.0mm: This product is applicable as X or Y capacitor

Features

① **IEC60384-14 Class X1/X2 certified product.**

Please down load Safety Standard Certification (Type GF: X1/Y2) from here.



② **Can be used as a Class Y2 capacitor.**

● **Switching Power Supply - Class 1 Equipment**

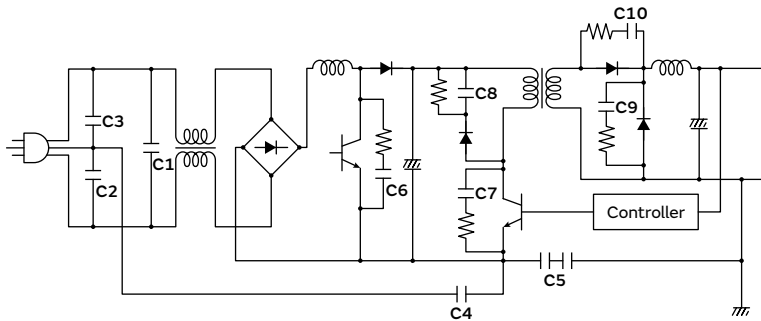

No.	Application	Recommend MLCC Type
C1	X Cap	Type: GB
C2	Y Cap	Type: GF
C3		
C4		
C5	Primary - Secondary Coupling	Type: GF×2

● **Switching Power Supply - Class 2 Equipment**

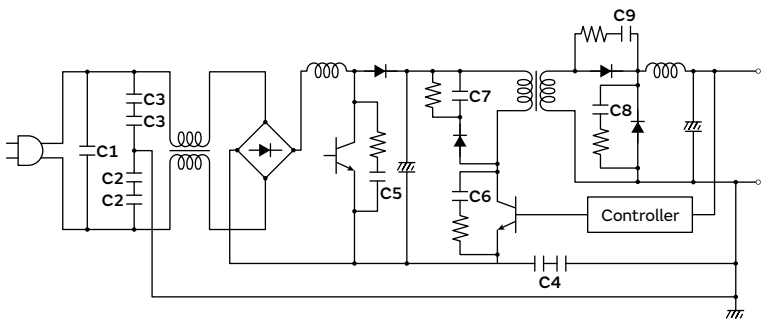

No.	Application	Recommend MLCC Type
C1	X Cap	Type: GB
C2	Y Cap	Type: GF×2
C3		
C4	Primary - Secondary Coupling	

- GRM
- GR3
- GRJ
- GR4
- GJM
- GQM
- GA2
- GA3 GB
- GA3 GD
- GA3 GF**
- LLL
- LLA
- LLM
- LLR
- NFM
- KRM
- KR3
- GMA
- GMD
- ⚠Caution / Notice

③ Realized large capacitance value and small size while maintaining high withstand voltages by the multilayer structure.

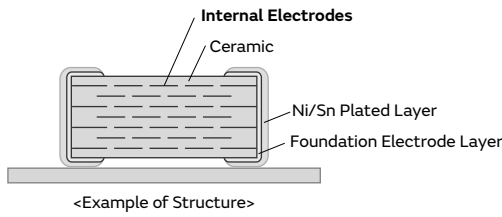

④ This product is only for reflow soldering.

Specifications

Size (mm)	4.5×2.0mm to 5.7×5.0mm
Rated Voltage	250Vac(r.m.s.)
Capacitance	10pF to 4700pF
Main Applications	AC-DC power supply

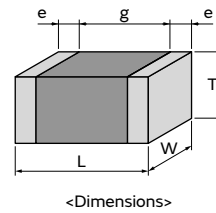

This catalog contains only a portion of the product lineup.
 Please refer to the capacitor search tool on the Murata Web site for details.

- GRM
- GR3
- GRJ
- GR4
- GJM
- GQM
- GA2
- GA3 GB
- GA3 GD
- GA3 GF
- LLL
- LLA
- LLM
- LLR
- NFM
- KRM
- KR3
- GMA
- GMD
- ⚠Caution /Notice

GA3 Series Type GF Temperature Compensating Type Part Number List

4.5×2.0mm

T max.	Rated Voltage	TC Code	Cap.	Tol.	Part Number
1.0mm	250Vac(r.m.s.)	SL	10pF	±5%	GA342A1XGF100JW31#
			12pF	±5%	GA342A1XGF120JW31#
			15pF	±5%	GA342A1XGF150JW31#
			18pF	±5%	GA342A1XGF180JW31#
			22pF	±5%	GA342A1XGF220JW31#
			27pF	±5%	GA342A1XGF270JW31#
			33pF	±5%	GA342A1XGF330JW31#
			39pF	±5%	GA342A1XGF390JW31#
			47pF	±5%	GA342A1XGF470JW31#
			56pF	±5%	GA342A1XGF560JW31#
			68pF	±5%	GA342A1XGF680JW31#
			82pF	±5%	GA342A1XGF820JW31#

- GRM
- GR3
- GRJ
- GR4
- GJM
- GQM
- GA2
- GA3 GB
- GA3 GD
- GA3 GF**
- LLL
- LLA
- LLM
- LLR
- NFM
- KRM
- KR3
- GMA
- GMD
- ⚠Caution /Notice

Part number # indicates the package specification code.

GA3 Series Type GF High Dielectric Constant Type Part Number List

4.5×2.0mm

T max.	Rated Voltage	TC Code	Cap.	Tol.	Part Number
1.5mm	250Vac(r.m.s.)	X7R	100pF	±10%	GA342QR7GF101KW01#
			150pF	±10%	GA342QR7GF151KW01#
			470pF	±10%	GA342QR7GF471KW01#
			680pF	±10%	GA342QR7GF681KW01#
2.2mm	250Vac(r.m.s.)	X7R	220pF	±10%	GA342DR7GF221KW02#
			330pF	±10%	GA342DR7GF331KW02#
			1000pF	±10%	GA342DR7GF102KW02#

5.7×2.8mm

T max.	Rated Voltage	TC Code	Cap.	Tol.	Part Number
1.5mm	250Vac(r.m.s.)	X7R	100pF	±10%	GA352QR7GF101KW31#
			150pF	±10%	GA352QR7GF151KW31#
			220pF	±10%	GA352QR7GF221KW31#
			330pF	±10%	GA352QR7GF331KW31#
			470pF	±10%	GA352QR7GF471KW01#
			680pF	±10%	GA352QR7GF681KW01#
			1000pF	±10%	GA352QR7GF102KW01#
			1500pF	±10%	GA352QR7GF152KW01#

5.7×5.0mm

T max.	Rated Voltage	TC Code	Cap.	Tol.	Part Number
1.5mm	250Vac(r.m.s.)	X7R	1800pF	±10%	GA355QR7GF182KW01#
			2200pF	±10%	GA355QR7GF222KW01#
			3300pF	±10%	GA355QR7GF332KW01#
2.0mm	250Vac(r.m.s.)	X7R	4700pF	±10%	GA355DR7GF472KW01#

- GRM
- GR3
- GRJ
- GR4
- GJM
- GQM
- GA2
- GA3 GB
- GA3 GD
- GA3 GF
- LLL
- LLA
- LLM
- LLR
- NFM
- KRM
- KR3
- GMA
- GMD
- △Caution /Notice

Part number # indicates the package specification code.

LW Reversed Low ESL Chip Multilayer Ceramic Capacitors for General Purpose

LLL Series



This low ESL capacitor is ideal for power supply decoupling of high-speed operation electronic equipment.

Features

1 Low ESL

Since the equivalent series inductance (ESL) is low and excellent in high frequency characteristics, this capacitor is suitable for power supply decoupling of high-speed operation electronic equipment.

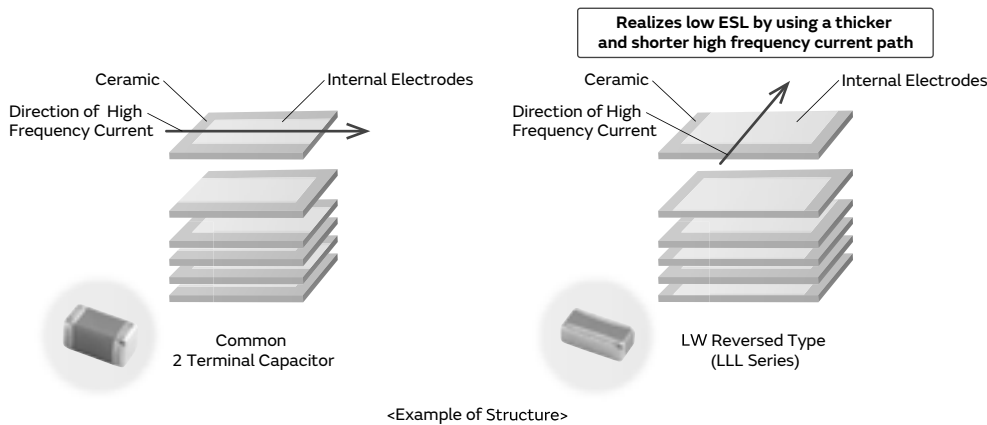

2 Contributes to a reduction in the number of components.

The number of components can be reduced by using low ESL capacitors, while maintaining functions equivalent to general purpose capacitors (GRM Series).

Murata proposes the use of the LLL series to reduce the number of components and high costs. Simulation is also possible.

Proposal for Cost Reductions

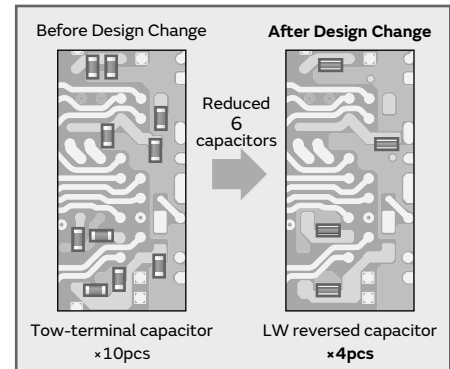

3 A maximum operating temperature up to 125°C

We also offer an abundant lineup of X7* characteristics that can be used in high temperature locations, such as IC packages.

Specifications

Size (mm)	0.5×1.0mm to 1.6×3.2mm
Rated Voltage	2.5Vdc to 50Vdc
Capacitance	2200pF to 10μF
Main Applications	Application processor/CPU/GPU

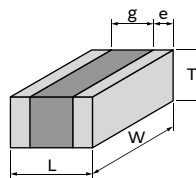

<Dimensions>

This catalog contains only a portion of the product lineup.
 Please refer to the capacitor search tool on the Murata Web site for details.

LLL Series High Dielectric Constant Type Part Number List

0.5×1.0mm

T max.	Rated Voltage	TC Code	Cap.	Tol.	Part Number
0.35mm	6.3Vdc	X6S	0.10μF	±20%	LLL153C80J104ME01#
			0.22μF	±20%	LLL153C80J224ME14#
	4Vdc	X7S	0.47μF	±20%	LLL153C70G474ME17#
		X6S	1.0μF	±20%	LLL153C80G105ME21#

0.6×1.0mm

T max.	Rated Voltage	TC Code	Cap.	Tol.	Part Number
0.45mm	4Vdc	X5R	4.3μF	±20%	LLL1U4R60G435ME22# D1

0.8×1.6mm

T max.	Rated Voltage	TC Code	Cap.	Tol.	Part Number
0.5mm	25Vdc	X7R	10000pF	±20%	LLL185R71E103MA11#
	16Vdc	X7R	22000pF	±20%	LLL185R71C223MA11#
			47000pF	±20%	LLL185R71C473MA11#
	10Vdc	X7R	0.10μF	±20%	LLL185R71A104MA11#
	4Vdc	X7S	0.22μF	±20%	LLL185C70G224MA11#
0.55mm	4Vdc	X7S	2.2μF	±20%	LLL185C70G225ME01#
0.6mm	50Vdc	X7R	2200pF	±20%	LLL185R71H222MA01#
			4700pF	±20%	LLL185R71H472MA01#
	25Vdc	X7R	10000pF	±20%	LLL185R71E103MA01#
			22000pF	±20%	LLL185R71E223MA01#
	16Vdc	X7R	47000pF	±20%	LLL185R71C473MA01#
	10Vdc	X7R	0.10μF	±20%	LLL185R71A104MA01#
			0.22μF	±20%	LLL185R71A224MA01#
	4Vdc	X7S	0.47μF	±20%	LLL185C70G474MA01#

1.25×2.0mm

T max.	Rated Voltage	TC Code	Cap.	Tol.	Part Number
0.5mm	50Vdc	X7R	10000pF	±20%	LLL215R71H103MA11#
	25Vdc	X7R	22000pF	±20%	LLL215R71E223MA11#
	16Vdc	X7R	47000pF	±20%	LLL215R71C473MA11#
			0.10μF	±20%	LLL215R71C104MA11#
	10Vdc	X7R	0.22μF	±20%	LLL215R71A224MA11#
	6.3Vdc	X7R	0.47μF	±20%	LLL215R70J474MA11#
	4Vdc	X7S	1.0μF	±20%	LLL215C70G105MA11#
0.7mm	50Vdc	X7R	10000pF	±20%	LLL216R71H103MA01#
			22000pF	±20%	LLL216R71H223MA01#
	25Vdc	X7R	47000pF	±20%	LLL216R71E473MA01#
			0.10μF	±20%	LLL216R71E104MA01#
	10Vdc	X7R	0.22μF	±20%	LLL216R71A224MA01#
0.95mm	16Vdc	X7R	0.22μF	±20%	LLL219R71C224MA01#
	10Vdc	X7R	0.47μF	±20%	LLL219R71A474MA01#
			1.0μF	±20%	LLL219R71A105MA01#
	4Vdc	X7S	2.2μF	±20%	LLL219C70G225MA01#

1.6×3.2mm

T max.	Rated Voltage	TC Code	Cap.	Tol.	Part Number
0.5mm	50Vdc	X7R	10000pF	±20%	LLL315R71H103MA11#
			22000pF	±20%	LLL315R71H223MA11#
	25Vdc	X7R	47000pF	±20%	LLL315R71E473MA11#
			0.10μF	±20%	LLL315R71E104MA11#
	16Vdc	X7R	0.22μF	±20%	LLL315R71C224MA11#
10Vdc	X7R	0.47μF	±20%	LLL315R71A474MA11#	
0.8mm	50Vdc	X7R	10000pF	±20%	LLL317R71H103MA01#
			22000pF	±20%	LLL317R71H223MA01#
			47000pF	±20%	LLL317R71H473MA01#
	25Vdc	X7R	0.10μF	±20%	LLL317R71E104MA01#
	16Vdc	X7R	0.22μF	±20%	LLL317R71C224MA01#
			0.47μF	±20%	LLL317R71C474MA01#
	10Vdc	X7R	1.0μF	±20%	LLL317R71A105MA01#
6.3Vdc	X7R	2.2μF	±20%	LLL317R70J225MA01#	
1.25mm	50Vdc	X7R	0.10μF	±20%	LLL31MR71H104MA01#
			0.22μF	±20%	LLL31MR71E224MA01#
	16Vdc	X7R	0.47μF	±20%	LLL31MR71E474MA01#
			1.0μF	±20%	LLL31MR71C105MA01#
	10Vdc	X7R	2.2μF	±20%	LLL31MR71A225MA01#
	6.3Vdc	X7R	4.7μF	±20%	LLL31MR70J475MA01#
X5R			10μF	±20%	LLL31MR60J106ME01#

- GRM
- GR3
- GRJ
- GR4
- GJM
- GQM
- GA2
- GA3 GB
- GA3 GD
- GA3 GF
- LLL
- LLA
- LLM
- LLR
- NFM
- KRM
- KR3
- GMA
- GMD
- ⚠Caution /Notice

8 Terminals Low ESL Chip Multilayer Ceramic Capacitors for General Purpose

LLA Series



8-Terminal Type Low ESL Capacitor Ideal for Power Supply Decoupling of High-speed Operation IC

Features

① Ultra-low ESL

Since the equivalent series inductance (ESL) is very low with excellent high frequency characteristics due to the design structure, this capacitor is ideal for power supply decoupling of high-speed operation IC.

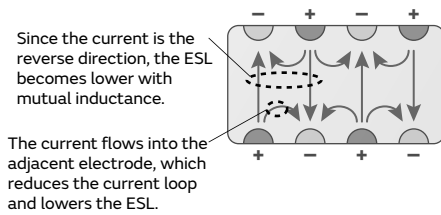
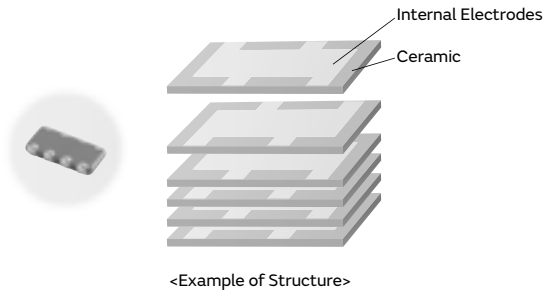

<Effectiveness of Cancelling Out Inductance by Mutual Inductance>

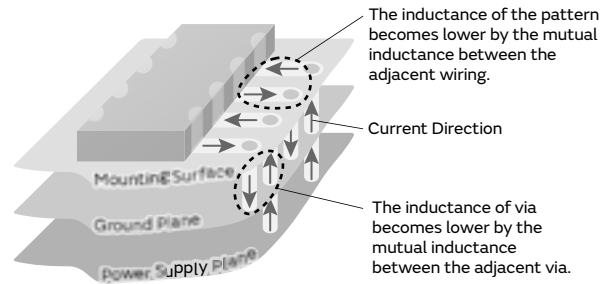

<Effectiveness of Suppressing Inductance when Mounting a Multi-terminal Capacitor>

The inductance for the boards also becomes lower, not only the capacitor.

② A maximum operating temperature up to 125°C

This product is applicable to high temperatures (X7* characteristics); however, Murata also offers numerous thin type products, which are ideal as decoupling capacitors on IC package.

Specifications

Size (mm)	1.6×0.8mm to 2.0×1.25mm
Rated Voltage	4Vdc to 25Vdc
Capacitance	10000pF to 4.7μF
Main Applications	Application processor/CPU/GPU

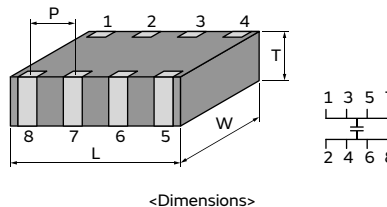

This catalog contains only a portion of the product lineup. Please refer to the capacitor search tool on the Murata Web site for details.

- GRM
- GR3
- GRJ
- GR4
- GJM
- GQM
- GA2
- GA3 GB
- GA3 GD
- GA3 GF
- LLL
- LLA
- LLM
- LLR
- NFM
- KRM
- KR3
- GMA
- GMD
- △Caution /Notice

LLA Series High Dielectric Constant Type Part Number List

1.6×0.8mm

T max.	Rated Voltage	TC Code	Cap.	Tol.	Part Number
0.55mm	4Vdc	X7S	0.10μF	±20%	LLA185C70G104MA01#
			0.22μF	±20%	LLA185C70G224MA01#
			0.47μF	±20%	LLA185C70G474MA01#
			2.2μF	±20%	LLA185C70G225ME16#

2.0×1.25mm

T max.	Rated Voltage	TC Code	Cap.	Tol.	Part Number
0.55mm	25Vdc	X7R	10000pF	±20%	LLA215R71E103MA14#
			22000pF	±20%	LLA215R71E223MA14#
	16Vdc	X7R	47000pF	±20%	LLA215R71C473MA14#
			0.10μF	±20%	LLA215R71C104MA14#
	10Vdc	X7R	0.22μF	±20%	LLA215R71A224MA14#
	6.3Vdc	X7R	0.47μF	±20%	LLA215R70J474MA14#
	4Vdc	X7S	1.0μF	±20%	LLA215C70G105MA14#
			4.7μF	±20%	LLA215C70G475ME19#
0.95mm	25Vdc	X7R	10000pF	±20%	LLA219R71E103MA01#
			22000pF	±20%	LLA219R71E223MA01#
			47000pF	±20%	LLA219R71E473MA01#
	16Vdc	X7R	0.10μF	±20%	LLA219R71C104MA01#
			0.22μF	±20%	LLA219R71C224MA01#
	10Vdc	X7R	0.47μF	±20%	LLA219R71A474MA01#
	6.3Vdc	X7R	1.0μF	±20%	LLA219R70J105MA01#
	4Vdc	X7S	2.2μF	±20%	LLA219C70G225MA01#

- GRM
- GR3
- GRJ
- GR4
- GJM
- GQM
- GA2
- GA3 GB
- GA3 GD
- GA3 GF
- LLL
- LLA
- LLM
- LLR
- NFM
- KRM
- KR3
- GMA
- GMD
- ⚠Caution /Notice

10 Terminals Low ESL Chip Multilayer Ceramic Capacitors for General Purpose

LLM Series



10-Terminal Type Low ESL Capacitor Ideal for Power Supply Decoupling of High-speed Operation IC

Features

① This is the lowest ESL LW reversed type capacitor.

Since the equivalent series inductance (ESL) of this product is even lower than the LLA series (8-terminal product) with excellent high frequency characteristics, this capacitor is ideal for power supply decoupling of high-speed operation IC.

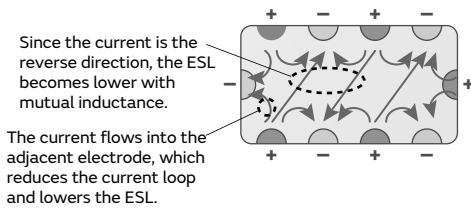
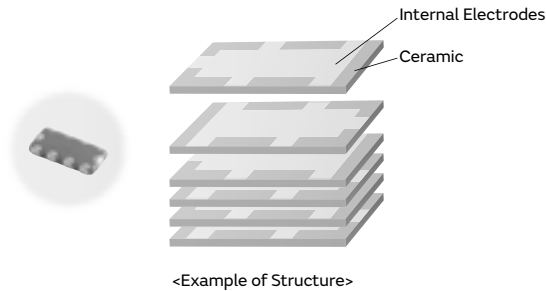

<Effectiveness of Cancelling Out Inductance by Mutual Inductance>

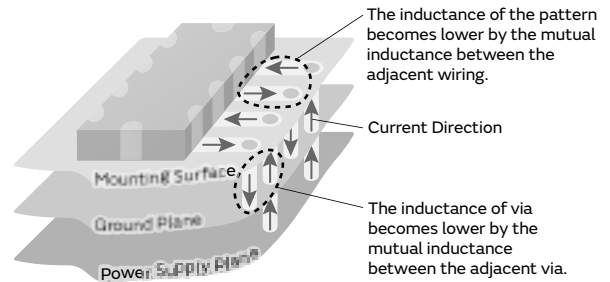

<Effectiveness of Suppressing Inductance when Mounting a Multi-terminal Capacitor>

The inductance for the boards also becomes lower, not only the capacitor.

② A maximum operating temperature up to 125°C

This product is applicable to high temperatures (X7* characteristics); however, Murata also offers numerous thin type products, which are ideal as decoupling capacitors on IC package.

Specifications

Size (mm)	2.0×1.25mm
Rated Voltage	4Vdc to 25Vdc
Capacitance	10000pF to 1.0μF
Main Applications	Application processor/CPU/GPU

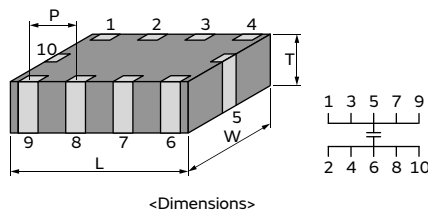

This catalog contains only a portion of the product lineup. Please refer to the capacitor search tool on the Murata Web site for details.

- GRM
- GR3
- GRJ
- GR4
- GJM
- GQM
- GA2
- GA3 GB
- GA3 GD
- GA3 GF
- LLL
- LLA
- LLM
- LLR
- NFM
- KRM
- KR3
- GMA
- GMD
- △Caution /Notice

LLM Series High Dielectric Constant Type Part Number List

2.0×1.25mm

T max.	Rated Voltage	TC Code	Cap.	Tol.	Part Number
0.55mm	25Vdc	X7R	10000pF	±20%	LLM215R71E103MA11#
			22000pF	±20%	LLM215R71E223MA11#
	16Vdc	X7R	47000pF	±20%	LLM215R71C473MA11#
			0.10μF	±20%	LLM215R71C104MA11#
	6.3Vdc	X7R	0.22μF	±20%	LLM215R70J224MA11#
			0.47μF	±20%	LLM215R70J474MA11#
	4Vdc	X7S	1.0μF	±20%	LLM215C70G105MA11#

- GRM
- GR3
- GRJ
- GR4
- GJM
- GQM
- GA2
- GA3 GB
- GA3 GD
- GA3 GF
- LLL
- LLA
- LLM**
- LLR
- NFM
- KRM
- KR3
- GMA
- GMD
- ⚠Caution /Notice

LW Reversed Controlled ESR Low ESL Chip Multilayer Ceramic Capacitors for General Purpose

LLR Series



ESR Controlled Type Low ESL Capacitors Equipped with Anti-resonance Control Function

Features

① **Reduces Anti-resonance**

This capacitor is controlled so that the equivalent series resistance (ESR) becomes slightly higher, and is effective in reducing the anti-resonance that occurs when capacitor arrays are used.

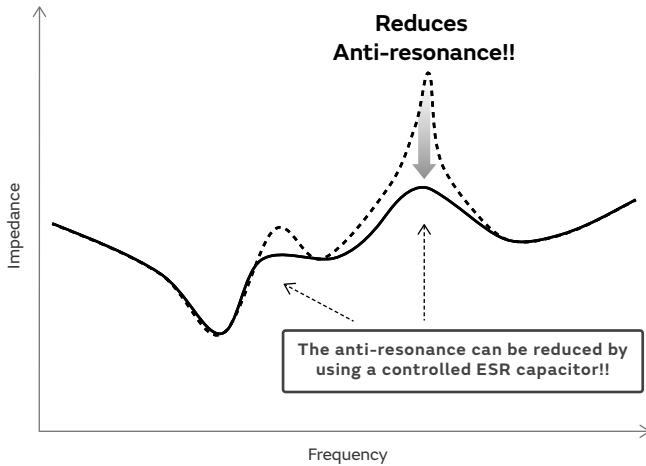

② **Lineup of capacitors with ESR values from 100-1,000mΩ.**

According to the conditions of the anti-resonance, the most suitable ESR value can be selected from 4 types.

③ **Low ESL**

This ESR controlled type capacitor has excellent high frequency characteristics, with low equivalent series inductance (ESL). This is also ideal as a decoupling component.

Specifications

Size (mm)	0.8×1.6mm
Rated Voltage	4Vdc
Capacitance	1.0μF
Main Applications	Network processor/ASIC/PMIC

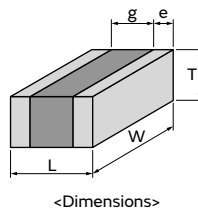

This catalog contains only a portion of the product lineup.
 Please refer to the capacitor search tool on the Murata Web site for details.

- GRM
- GR3
- GRJ
- GR4
- GJM
- GQM
- GA2
- GA3 GB
- GA3 GD
- GA3 GF
- LLL
- LLA
- LLM
- LLR**
- NFM
- KRM
- KR3
- GMA
- GMD
- ⚠Caution /Notice

LLR Series High Dielectric Constant Type Part Number List



0.8×1.6mm

T max.	Rated Voltage	TC Code	Cap.	Tol.	Part Number	
0.55mm	4Vdc	X7S	1.0μF	±20%	LLR185C70G105ME01#	
				±20%	LLR185C70G105ME03#	
				±20%	LLR185C70G105ME05#	
				±20%	LLR185C70G105ME07#	

- GRM
- GR3
- GRJ
- GR4
- GJM
- GQM
- GA2
- GA3 GB
- GA3 GD
- GA3 GF
- LLL
- LLA
- LLM
- LLR**
- NFM
- KRM
- KR3
- GMA
- GMD
- ⚠Caution /Notice

Part number # indicates the package specification code.

3 Terminals Low ESL Chip Multilayer Ceramic Capacitors for General Purpose

NFM Series  **Low ESL** **EMI Filter** **WEB** 

This is the most suitable Low ESL capacitors for noise measurement and power decoupling of highspeed electrical devices.

Features

① Low ESL

Since the equivalent series inductance (ESL) is low and excellent in high frequency characteristics, this capacitor is suitable for power supply decoupling of high-speed operation electronic equipment.

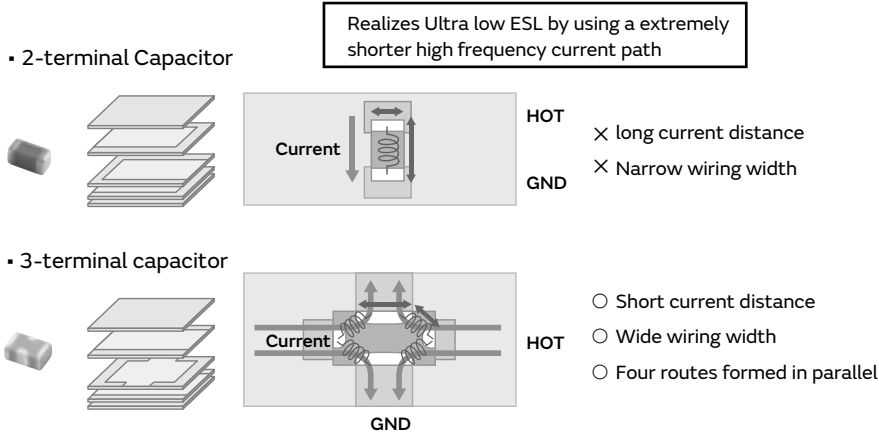

② Contributes to a reduction in the number of components.

The number of components can be reduced by using low ESL capacitors, while maintaining functions equivalent to 2-terminal capacitor.

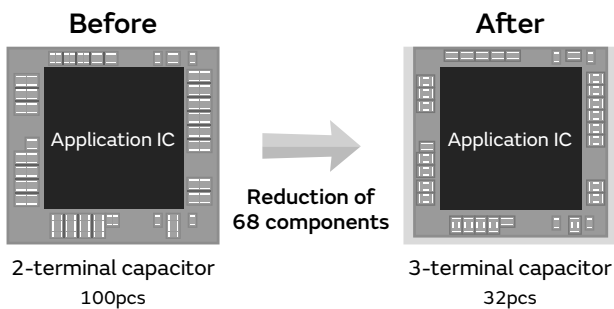

GRM
 GR3
 GRJ
 GR4
 GJM
 GQM
 GA2
 GA3 GB
 GA3 GD
 GA3 GF
 LLL
 LLA
 LLM
 LLR
 NFM
 KRM
 KR3
 GMA
 GMD
 ⚠Caution /Notice

③ Contributes to noise suppression as an EMI filter

Without NFM series

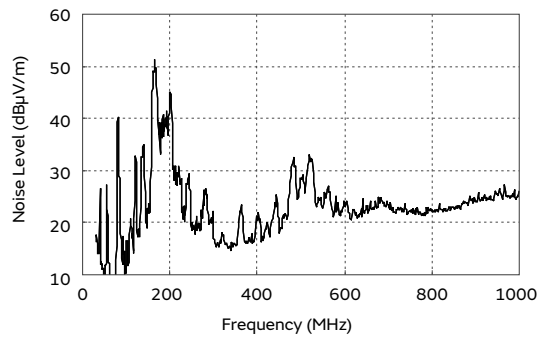
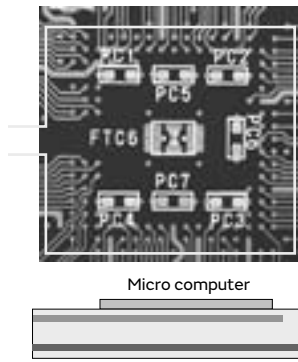

With NFM series 1 μ F \times 1pc

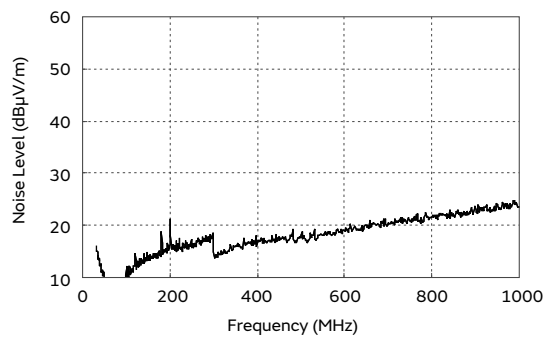
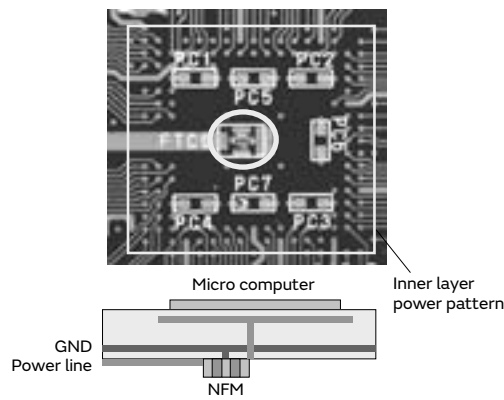

Example of noise suppression effect



Specifications

Size (mm)	1.0 \times 0.5mm to 4.5 \times 1.6mm
Rated Voltage	2.5Vdc to 100Vdc
Capacitance	100pF to 27 μ F
Main Applications	Application processor, PMIC

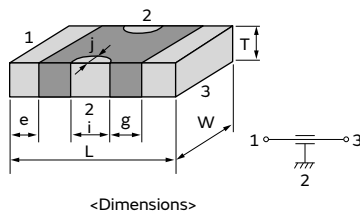

GRM
 GR3
 GRJ
 GR4
 GJM
 GQM
 GA2
 GA3 GB
 GA3 GD
 GA3 GF
 LLL
 LLA
 LLM
 LLR
 NFM
 KRM
 KR3
 GMA
 GMD
 ⚠Caution / Notice

NFM Series Part Number List

1.0×0.5mm

T max.	Rated Voltage	Cap.	Tol.	Part Number
0.35mm	6.3Vdc	0.47μF	±20%	NFM15PC474R0J3#
	4Vdc	0.47μF	±20%	NFM15PC474D0G3#
		1.0μF	±20%	NFM15PC105R0G3#
0.5mm	16Vdc	2200pF	±20%	NFM15CC222D1C3#
		22000pF	±20%	NFM15CC223C1C3#
		47000pF	±20%	NFM15PC473C1C3#
	10Vdc	2200pF	±20%	NFM15CC222D1A3#
		22000pF	±20%	NFM15CC223C1A3#
		47000pF	±20%	NFM15PC473C1A3#
		0.10μF	±20%	NFM15PC104R1A3#
		0.22μF	±20%	NFM15PC224R1A3#
	6.3Vdc	0.10μF	±20%	NFM15PC104D0J3#
		0.22μF	±20%	NFM15PC224D0J3#
2.5Vdc	4.3μF	±20%	NFM15PC435R0E3#	
0.65mm	2.5Vdc	7.5μF	±20%	NFM15PC755R0E3#
0.7mm	2.5Vdc	9.1μF	±20%	NFM15PC915R0E3#

1.6×0.8mm

T max.	Rated Voltage	Cap.	Tol.	Part Number
0.7mm	16Vdc	100pF	±20%	NFM18CC101R1C3#
		220pF	±20%	NFM18CC221R1C3#
		470pF	±20%	NFM18CC471R1C3#
		1000pF	±20%	NFM18CC102R1C3#
		2200pF	±20%	NFM18CC222R1C3#
		22000pF	±20%	NFM18CC223R1C3#
		0.10μF	±20%	NFM18PC104R1C3#
	6.3Vdc	0.22μF	±20%	NFM18PC224R0J3#
		0.47μF	±20%	NFM18PC474R0J3#
			±20%	NFM18PS474R0J3#
1.0μF	±20%	NFM18PS105D0J3#		
		±20%	NFM18PS105R0J3#	
0.9mm	10Vdc	2.2μF	±20%	NFM18PC225B1A3#
	6.3Vdc	1.0μF	±20%	NFM18PC105R0J3#

2.0×1.25mm

T max.	Rated Voltage	Cap.	Tol.	Part Number
0.95mm	50Vdc	220pF	±20%	NFM21CC221R1H3#
		470pF	±20%	NFM21CC471R1H3#
		1000pF	±20%	NFM21CC102R1H3#
		2200pF	±20%	NFM21CC222R1H3#
		22000pF	±20%	NFM21CC223R1H3#
	25Vdc	0.10μF	±20%	NFM21PC104R1E3#
	16Vdc	0.22μF	±20%	NFM21PC224R1C3#
		0.47μF	±20%	NFM21PC474R1C3#
		1.0μF	±20%	NFM21PC105B1C3#
	10Vdc	1.0μF	±20%	NFM21PC105B1A3#
4.7μF		±20%	NFM21PC475B1A3#	

T max.	Rated Voltage	Cap.	Tol.	Part Number
0.95mm	6.3Vdc	2.2μF	±20%	NFM21PC225B0J3#
		10μF	±20%	NFM21PS106B0J3#

3.2×1.25mm

T max.	Rated Voltage	Cap.	Tol.	Part Number
0.9mm	50Vdc	220pF	+50/-20%	NFM3DCC221R1H3#
		470pF	+50/-20%	NFM3DCC471R1H3#
		1000pF	+50/-20%	NFM3DCC102R1H3#
		2200pF	+50/-20%	NFM3DCC222R1H3#
		22000pF	+50/-20%	NFM3DCC223R1H3#
			±20%	NFM3DPC223R1H3#

3.2×1.6mm

T max.	Rated Voltage	Cap.	Tol.	Part Number
1.5mm	100Vdc	10000pF	±20%	NFM31KC103R2A3#
		15000pF	±20%	NFM31KC153R2A3#
		22000pF	±20%	NFM31KC223R2A3#
		0.10μF	±20%	NFM31KC104R2A3#
	50Vdc	10000pF	±20%	NFM31KC103R1H3#
		15000pF	±20%	NFM31KC153R1H3#
		22000pF	±20%	NFM31KC223R1H3#
		0.10μF	±20%	NFM31KC104R1H3#
	6.3Vdc	27μF	±20%	NFM31PC276B0J3#

4.5×1.6mm

T max.	Rated Voltage	Cap.	Tol.	Part Number
1.2mm	100Vdc	470pF	+50/-20%	NFM41CC471R2A3#
		1000pF	+50/-20%	NFM41CC102R2A3#
		2200pF	+50/-20%	NFM41CC222R2A3#
		22000pF	+50/-20%	NFM41CC223R2A3#
	50Vdc	1.5μF	±20%	NFM41PC155B1H3#
	25Vdc	1.5μF	±20%	NFM41PC155B1E3#

Part number # indicates the package specification code.

GRM
GR3
GRJ
GR4
GJM
GQM
GA2
GA3 GB
GA3 GD
GA3 GF
LLL
LLA
LLM
LLR
NFM
KRM
KR3
GMA
GMD
⚠Caution / Notice

Metal Terminal Type Multilayer Ceramic Capacitors for General Purpose

KRM Series



Anti-noise

Deflecting crack

Soldering crack

WEB

Bonding the metal terminals to external electrodes solves design issues by mounting large size MLCC!

Features

① **Bond metal terminals to the external electrodes of chips.**

The stress applied to the chip is relieved by the elastic action of the metal terminal.

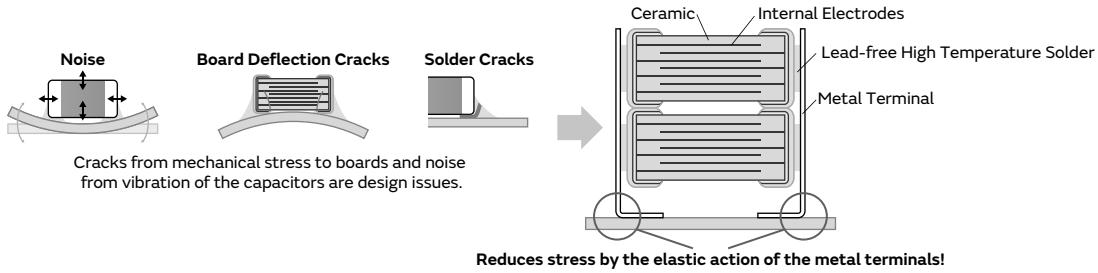

② **Substantially reduces noise, board deflection cracks and soldering cracks.**

This product is not damaged even with a board deflection of 6 mm.

Solder cracks do not occur even with 2,000 cycles of heat stress.

● **Acoustic Noise is Reduced with Metal Terminals**

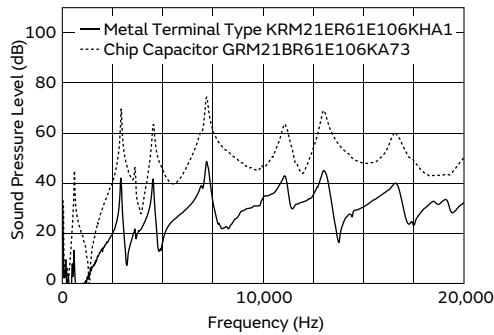

● **Reduces Stress Caused by Board Deflection**

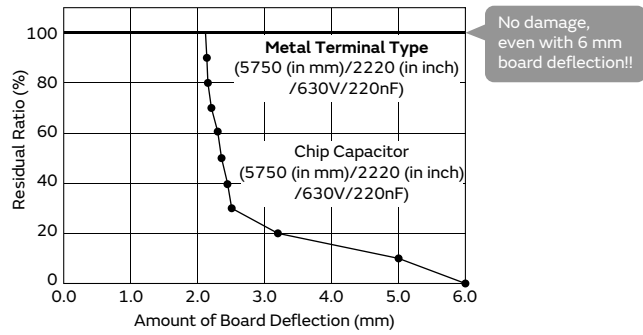

● **Suppresses Solder Cracks Caused by Heat Stress**

Chip Size	Chip Only (5750 (in mm)/2220 (in inch) size)	Metal Terminal Type (5750 (in mm)/2220 (in inch) size)
1000 Cycle	 ↑ Solder Crack	
2000 Cycle	 ↑ Solder Crack	

Compared with chips only, this product is excellent in solder cracking resistance.

Test Condition: -55 to +125°C, 5min.,(Liquid Phase)
 Board Used: Glass Epoxy Board (FR-4)

Demonstrates replacement value of low noise capacitors Experience the effectiveness of the KRM Series.

▶ Examples of Noise Countermeasures

WEB

GRM
 GR3
 GRJ
 GR4
 GJM
 GQM
 GA2
 GA3 GB
 GA3 GD
 GA3 GF
 LLL
 LLA
 LLM
 LLR
 NFM
 KRM
 KR3
 GMA
 GMD
 ⚠️Caution / Notice

③ **2 chips can be stacked.**

Realize large capacity by stacking 2 capacitors.

Specifications

Size (mm)	2.2×1.25mm to 6.1×5.3mm
Rated Voltage	16Vdc to 1000Vdc
Capacitance	0.015μF to 100μF
Main Applications	For smoothing and noise suppression of DC-DC converters

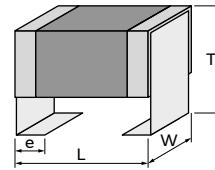

<Dimensions>

This catalog contains only a portion of the product lineup.
 Please refer to the capacitor search tool on the Murata Web site for details.

GRM

GR3

GRJ

GR4

GJM

GQM

GA2

GA3
GB

GA3
GD

GA3
GF

LLL

LLA

LLM

LLR

NFM

KRM

KR3

GMA

GMD

⚠Caution
/Notice

KRM Series Temperature Compensating Type Part Number List

6.1×5.1mm

T max.	Rated Voltage	TC Code	Cap.	Tol.	Part Number	
3.1mm	630Vdc	COG	0.015μF	±5%	KRM55L5C2J153JDL1#	
			0.018μF	±5%	KRM55L5C2J183JDL1#	
3.9mm	630Vdc	COG	0.022μF	±5%	KRM55R5C2J223JDL1#	
			0.027μF	±5%	KRM55R5C2J273JDL1#	
5.1mm	630Vdc	COG	0.030μF	±5%	KRM55T5C2J303JDL1#	
			0.036μF	±5%	KRM55T5C2J363JDL1#	
6.6mm	630Vdc	COG	0.044μF	±5%	KRM55V5C2J443JDL2#	
			0.054μF	±5%	KRM55V5C2J543JDL2#	

- GRM
- GR3
- GRJ
- GR4
- GJM
- GQM
- GA2
- GA3 GB
- GA3 GD
- GA3 GF
- LLL
- LLA
- LLM
- LLR
- NFM
- KRM**
- KR3
- GMA
- GMD
- ⚠Caution /Notice

Part number # indicates the package specification code.

KRM Series High Dielectric Constant Type Anti-noise Deflecting crack Soldering crack Part Number List

2.2×1.25mm

T max.	Rated Voltage	TC Code	Cap.	Tol.	Part Number
1.9mm	25Vdc	X5R	10μF	±10%	KRM21ER61E106KFA1#
	16Vdc	X5R	10μF	±10%	KRM21ER61C106KFA1#
2.0mm	25Vdc	X7S	10μF	±10%	KRM21FC71E106KFA1# D1
		X6S	10μF	±10%	KRM21FC81E106KFA1# D1
		X5R	22μF	±20%	KRM21FR61E226MFA1#

3.5×1.7mm

T max.	Rated Voltage	TC Code	Cap.	Tol.	Part Number
2.0mm	25Vdc	X5R	10μF	±10%	KRM31FR61E106KH01#
2.9mm	100Vdc	X7R	1.0μF	±10%	KRM31KR72A105KH01#
	50Vdc	X7R	4.7μF	±10%	KRM31KR71H475KH01#
	35Vdc	X6S	10μF	±10%	KRM31KC8YA106KH01#
	25Vdc	X6S	10μF	±10%	KRM31KC81E106KH01#

3.6×1.7mm

T max.	Rated Voltage	TC Code	Cap.	Tol.	Part Number
2.9mm	50Vdc	X7R	2.2μF	±10%	KRM31KR71H225KH01#

3.7×1.85mm

T max.	Rated Voltage	TC Code	Cap.	Tol.	Part Number
2.9mm	100Vdc	X7R	2.2μF	±10%	KRM31KR72A225KH01#

6.1×5.3mm

T max.	Rated Voltage	TC Code	Cap.	Tol.	Part Number
3.0mm	1000Vdc	X7R	68000pF	±10%	KRM55LR73A683KH01#
			0.10μF	±10%	KRM55LR73A104KH01#
	630Vdc	X7R	0.15μF	±10%	KRM55LR72J154KH01#
			0.22μF	±10%	KRM55LR72J224KH01#
	450Vdc	X7R	0.33μF	±10%	KRM55LR72W334KH01#
			0.47μF	±10%	KRM55LR72W474KH01#
	250Vdc	X7R	0.68μF	±10%	KRM55LR72E684KH01#
			1.0μF	±10%	KRM55LR72E105KH01#
	100Vdc	X7R	4.7μF	±10%	KRM55LR72A475KH01#
	63Vdc	X7R	4.7μF	±10%	KRM55LR71J475KH01#
			4.7μF	±10%	KRM55LR71H475KH01#
	50Vdc	X7R	4.7μF	±10%	KRM55LR71H106KH01#
			10μF	±10%	KRM55LR71H106KH01#
	35Vdc	X7R	10μF	±10%	KRM55LR7YA106KH01#
			15μF	±10%	KRM55LR7YA156KH01#
25Vdc	X7R	15μF	±10%	KRM55LR71E156KH01#	
3.9mm	100Vdc	X7R	6.8μF	±10%	KRM55QR72A685KH01#
			10μF	±10%	KRM55QR72A106KH01#
	63Vdc	X7R	10μF	±10%	KRM55QR71J106KH01#
	50Vdc	X7R	10μF	±10%	KRM55QR71H106KH01#
			17μF	±10%	KRM55QR71H176KH01#

T max.	Rated Voltage	TC Code	Cap.	Tol.	Part Number
3.9mm	35Vdc	X7R	17μF	±10%	KRM55QR7YA176KH01#
			22μF	±10%	KRM55QR7YA226KH01#
	25Vdc	X7R	22μF	±10%	KRM55QR71E226KH01#
			33μF	±10%	KRM55QR71E336KH01#
	X7S	47μF	±10%	KRM55QC71E476KH13#	
5.0mm	1000Vdc	X7R	0.15μF	±20%	KRM55TR73A154MH01#
			0.22μF	±20%	KRM55TR73A224MH01#
	630Vdc	X7R	0.33μF	±20%	KRM55TR72J334MH01#
			0.47μF	±20%	KRM55TR72J474MH01#
	450Vdc	X7R	0.68μF	±20%	KRM55TR72W684MH01#
			1.0μF	±20%	KRM55TR72W105MH01#
	250Vdc	X7R	1.5μF	±20%	KRM55TR72E155MH01#
			2.2μF	±20%	KRM55TR72E225MH01#
	100Vdc	X7R	10μF	±20%	KRM55TR72A106MH01#
	50Vdc	X7R	22μF	±20%	KRM55TR71H226MH01#
	35Vdc	X7R	22μF	±20%	KRM55TR7YA226MH01#
			33μF	±20%	KRM55TR7YA336MH01#
25Vdc	X7R	33μF	±20%	KRM55TR71E336MH01#	
6.7mm	100Vdc	X7R	15μF	±20%	KRM55WR72A156MH01#
			22μF	±20%	KRM55WR72A226MH01#
	63Vdc	X7R	22μF	±20%	KRM55WR71J226MH01#
	50Vdc	X7R	22μF	±20%	KRM55WR71H226MH01#
			33μF	±20%	KRM55WR71H336MH01#
	35Vdc	X7R	33μF	±20%	KRM55WR7YA336MH01#
			47μF	±20%	KRM55WR7YA476MH01#
	25Vdc	X7R	47μF	±20%	KRM55WR71E476MH01#
68μF			±20%	KRM55WR71E686MH01#	
	X7S	100μF	±20%	KRM55WC71E107MH13#	

GRM
 GR3
 GRJ
 GR4
 GJM
 GQM
 GA2
 GA3 GB
 GA3 GD
 GA3 GF
 LLL
 LLA
 LLM
 LLR
 NFM
 KRM
 KR3
 GMA
 GMD
 ⚠Caution /Notice

High Effective Capacitance & High Allowable Ripple Current Metal Terminal Type Multilayer Ceramic Capacitors for General Purpose

KR3 Series



Anti-noise

Deflecting crack

Soldering crack

WEB

Bonding the metal terminals to external electrodes solves design issues by mounting large size MLCC!

Features

1 Bond Metal Terminals to External Electrodes of Chips

This product has high resistance to heat and mechanical impact and greatly reduces acoustic noise of boards by ceramics.

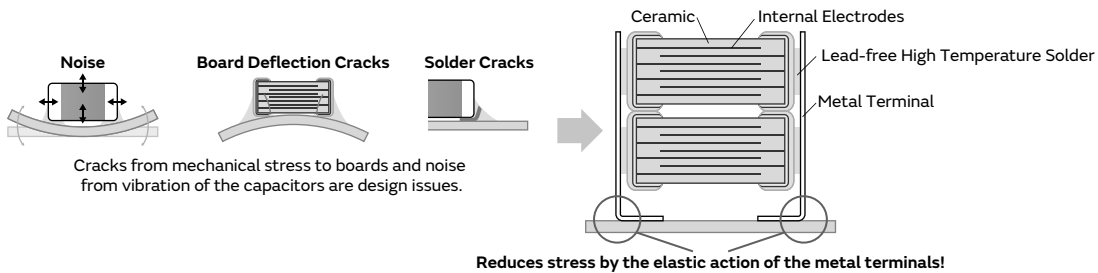

2 Stacking of Chips

Achieve high capacity by stacking 2 capacitors.

Comparison of Noise Reduction Effects

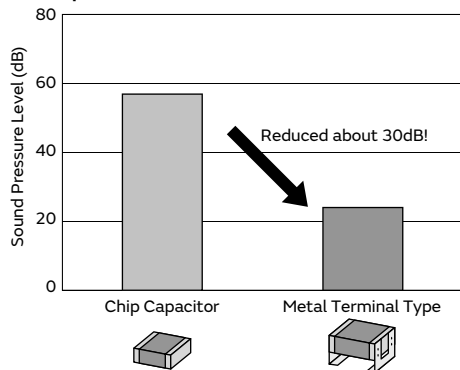

Evaluation Items: 5750 (in mm)/2220 (in inch) size/DC630V/220nF
 Test Method: DC50V, AC10Vp-p/3kHz
 Test Board: Glass Epoxy Board (T=1.6mm)
 Test Quantity: 3pc
 Distance Between Microphone and Board: 5mm

Note: Results Using Murata's Evaluation Board

Reduces Stress Caused by Board Deflection

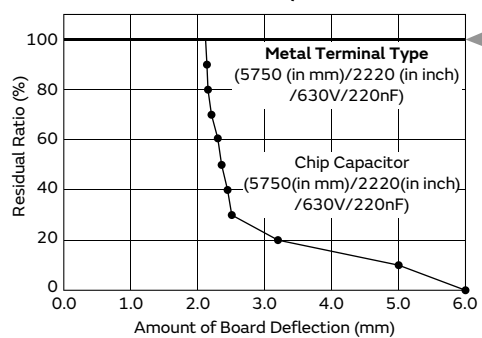

Suppresses Solder Cracks Caused by Heat Stress

Chip Size	Chip Only (5750 (in mm)/2220 (in inch) size)	Metal Terminal Type (5750 (in mm)/2220 (in inch) size)
1000 Cycle	 ↑ Solder Crack	
2000 Cycle	 ↑ Solder Crack	

Compared with chips only, this product is excellent in solder cracking resistance.

Test Condition: -55 to +125°C, 5min., (Liquid Phase)
 Board Used: Glass Epoxy Board (FR-4)

3 Adopted Low Dielectric Constant Materials

Improved effective capacity and ripple resistant performance, compared to conventional products (X7R characteristics).

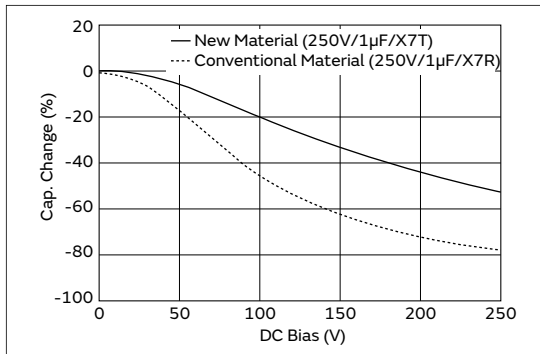

Specifications

Size (mm)	6.1×5.3mm
Rated Voltage	250Vdc to 630Vdc
Capacitance	0.10µF to 2.2µF
Main Applications	For DC-DC converters of general electronic equipment

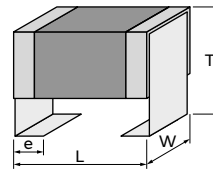

<Dimensions>

This catalog contains only a portion of the product lineup.
 Please refer to the capacitor search tool on the Murata Web site for details.

- GRM
- GR3
- GRJ
- GR4
- GJM
- GQM
- GA2
- GA3 GB
- GA3 GD
- GA3 GF
- LLL
- LLA
- LLM
- LLR
- NFM
- KRM
- KR3
- GMA
- GMD
- ⚠Caution /Notice

KR3 Series High Dielectric Constant Type Anti-noise Deflecting crack Soldering crack Part Number List

6.1×5.3mm

T max.	Rated Voltage	TC Code	Cap.	Tol.	Part Number
3.0mm	630Vdc	X7T	0.10μF	±10%	KR355LD72J104KH01#
			0.15μF	±10%	KR355LD72J154KH01#
	450Vdc	X7T	0.22μF	±10%	KR355LD72W224KH01#
			0.33μF	±10%	KR355LD72W334KH01#
			0.47μF	±10%	KR355LD72W474KH01#
	250Vdc	X7T	0.47μF	±10%	KR355LD72E474KH01#
0.68μF			±10%	KR355LD72E684KH01#	
3.9mm	630Vdc	X7T	0.22μF	±10%	KR355QD72J224KH01#
			0.27μF	±10%	KR355QD72J274KH01#
	450Vdc	X7T	0.56μF	±10%	KR355QD72W564KH01#
			1.0μF	±10%	KR355QD72E105KH01#
5.0mm	450Vdc	X7T	0.68μF	±20%	KR355TD72W684MH01#
			1.0μF	±20%	KR355TD72W105MH01#
	250Vdc	X7T	1.5μF	±20%	KR355TD72E155MH01#
6.7mm	630Vdc	X7T	0.47μF	±20%	KR355WD72J474MH01#
			0.56μF	±20%	KR355WD72J564MH01#
	450Vdc	X7T	1.2μF	±20%	KR355WD72W125MH01#
			2.2μF	±20%	KR355WD72E225MH01#

- GRM
- GR3
- GRJ
- GR4
- GJM
- GQM
- GA2
- GA3 GB
- GA3 GD
- GA3 GF
- LLL
- LLA
- LLM
- LLR
- NFM
- KRM
- KR3**
- GMA
- GMD
- ⚠Caution /Notice

Part number # indicates the package specification code.

Wire Bonding Mount Multilayer Microchip Capacitors for General Purpose

GMA Series



These capacitors have gold-plated electrodes and are designed specifically for wire bonding.

Features

① **Allows for high density mounting.**

Noise can be reduced by eliminating the routing of the wire, and high efficiency can be achieved with a built-in capacitor in a package, such as IC. Miniaturization of the set is also possible.

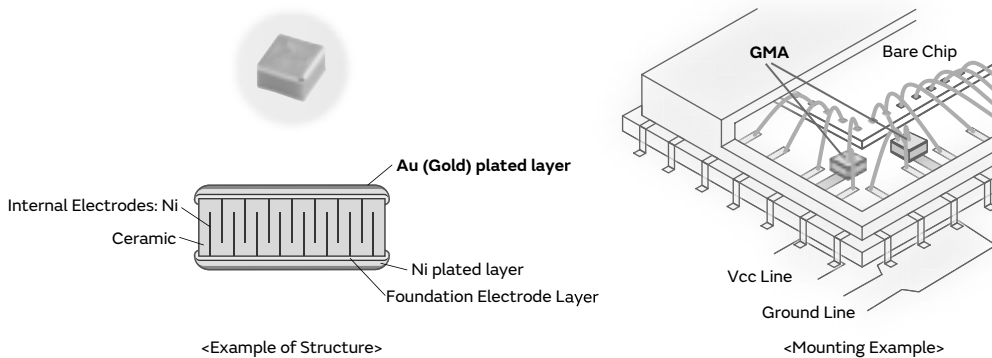

② **Achieved small size and high capacitance with a multilayer structure.**

Small size, high capacitance	Minimum 0.38mm×0.38mm Achieved 0.1μF in 0.5mm×0.5mm size
------------------------------	-------------------------------------------------------------

Lineup comparison table with competitor's is provided in my Murata Capacitor Site (need to sign in & approval from the site)



③ **Ideal for bypass applications**

Especially for optical communication related devices such as TOSA/ROSA.

④ **Excellent in high frequency characteristics.**

Since the capacitor consists of an upper/lower electrode structure, the current path becomes shorter and lowers the ESL. Compared with the general purpose GRM series of the same capacity, the impedance of this product becomes lower at high frequencies.

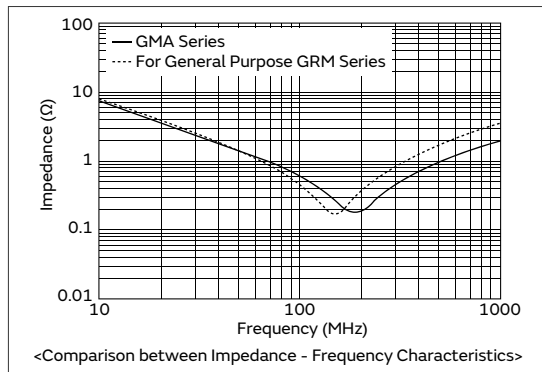

- GRM
- GR3
- GRJ
- GR4
- GJM
- GQM
- GA2
- GA3 GB
- GA3 GD
- GA3 GF
- LLL
- LLA
- LLM
- LLR
- NFM
- KRM
- KR3
- GMA
- GMD
- ⚠Caution /Notice

Specifications

Size (mm)	0.38×0.38mm to 0.8×0.8mm
Rated Voltage	6.3Vdc to 100Vdc
Capacitance	100pF to 0.47μF
Main Applications	1. Optical communication related devices such as TOSA/ROSA. 2. Various device related, such as GaAsIC (mounted in IC packages) 3. Measuring instruments, other ultra compact/thin devices

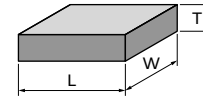

<Dimensions>

This catalog contains only a portion of the product lineup.
 Please refer to the capacitor search tool on the Murata Web site for details.

GRM

GR3

GRJ

GR4

GJM

GQM

GA2

GA3
GB

GA3
GD

GA3
GF

LLL

LLA

LLM

LLR

NFM

KRM

KR3

GMA

GMD

⚠Caution
/Notice

GMA Series High Dielectric Constant Type Bonding Part Number List

0.38×0.38mm

T max.	Rated Voltage	TC Code	Cap.	Tol.	Part Number
0.35mm	10Vdc	X7R	1000pF	±20%	GMA0D3R71A102MA01#
			1500pF	±20%	GMA0D3R71A152MA01#
			1800pF	±20%	GMA0D3R71A182MA01#
			10000pF	±20%	GMA0D3R71A103MA01#
		R	1000pF	±20%	GMA0D3R11A102MA01#
			1500pF	±20%	GMA0D3R11A152MA01#
			1800pF	±20%	GMA0D3R11A182MA01#
			10000pF	±20%	GMA0D3R11A103MA01#
		B	1000pF	±20%	GMA0D3B11A102MA01#
			1500pF	±20%	GMA0D3B11A152MA01#
			1800pF	±20%	GMA0D3B11A182MA01#
			1800pF	±20%	GMA0D3B11A182MA01#

0.5×0.5mm

T max.	Rated Voltage	TC Code	Cap.	Tol.	Part Number	
0.4mm	100Vdc	X7R	100pF	±20%	GMA05XR72A101MA01#	
			150pF	±20%	GMA05XR72A151MA01#	
			220pF	±20%	GMA05XR72A221MA01#	
			330pF	±20%	GMA05XR72A331MA01#	
			470pF	±20%	GMA05XR72A471MA01#	
			680pF	±20%	GMA05XR72A681MA01#	
			1000pF	±20%	GMA05XR72A102MA01#	
			25Vdc	X7R	1500pF	±20%
		2200pF			±20%	GMA05XR71E222MA11#
		3300pF			±20%	GMA05XR71E332MA11#
		4700pF			±20%	GMA05XR71E472MA11#
		B		1500pF	±20%	GMA05XB31E152MA11#
				2200pF	±20%	GMA05XB31E222MA11#
				3300pF	±20%	GMA05XB31E332MA11#
				4700pF	±20%	GMA05XB31E472MA11#
		10Vdc	X7R	6800pF	±20%	GMA05XR71A682MA01#
	10000pF			±20%	GMA05XR71A103MA01#	
	15000pF			±20%	GMA05XR71A153MA01#	
	22000pF			±20%	GMA05XR71A223MA01#	
	R			6800pF	±20%	GMA05XR11A682MA01#
				10000pF	±20%	GMA05XR11A103MA01#
				15000pF	±20%	GMA05XR11A153MA01#
				22000pF	±20%	GMA05XR11A223MA01#
	B		6800pF	±20%	GMA05XB11A682MA01#	
			10000pF	±20%	GMA05XB11A103MA01#	
			15000pF	±20%	GMA05XB11A153MA01#	
			22000pF	±20%	GMA05XB11A223MA01#	
	6.3Vdc		X5R	0.10μF	±20%	GMA05XR60J104ME12#
				B	0.10μF	±20%

0.8×0.8mm

T max.	Rated Voltage	TC Code	Cap.	Tol.	Part Number
0.6mm	100Vdc	X7R	1500pF	±20%	GMA085R72A152MA01#
			2200pF	±20%	GMA085R72A222MA01#

T max.	Rated Voltage	TC Code	Cap.	Tol.	Part Number	
0.6mm	100Vdc	X7R	3300pF	±20%	GMA085R72A332MA01#	
			4700pF	±20%	GMA085R72A472MA01#	
			6800pF	±20%	GMA085R72A682MA01#	
		25Vdc	X7R	10000pF	±20%	GMA085R71E103MA11#
				15000pF	±20%	GMA085R71E153MA11#
				22000pF	±20%	GMA085R71E223MA11#
	10Vdc	X7R	33000pF	±20%	GMA085R71A333MA01#	
			47000pF	±20%	GMA085R71A473MA01#	
			68000pF	±20%	GMA085R71A683MA01#	
		R	0.10μF	±20%	GMA085R71A104MA01#	
			33000pF	±20%	GMA085R11A333MA01#	
			47000pF	±20%	GMA085R11A473MA01#	
	6.3Vdc	X5R	68000pF	±20%	GMA085R11A683MA01#	
			0.10μF	±20%	GMA085R11A104MA01#	
			0.10μF	±20%	GMA085R11A104MA01#	
		B	33000pF	±20%	GMA085B11A333MA01#	
			47000pF	±20%	GMA085B11A473MA01#	
			68000pF	±20%	GMA085B11A683MA01#	
	6.3Vdc	X5R	0.47μF	±20%	GMA085R60J474ME12#	
			B	0.47μF	±20%	GMA085B30J474ME12#

GRM
 GR3
 GRJ
 GR4
 GJM
 GQM
 GA2
 GA3 GB
 GA3 GD
 GA3 GF
 LLL
 LLA
 LLM
 LLR
 NFM
 KRM
 KR3
 GMA
 GMD
 ⚠Caution /Notice

Part number # indicates the package specification code.

Wire Bonding/AuSn Soldering Mount Chip Multilayer Ceramic Capacitors for General Purpose

GMD Series



These capacitors have gold-plated electrodes and are designed specifically for wire bonding and use of gold-tin (AuSn) solder.

Features

① Designed specifically for wire bonding and use of gold-tin (AuSn) solder.

The gold-plated external electrodes make these devices suitable for wire bonding or use of gold tin (AuSn) solder.

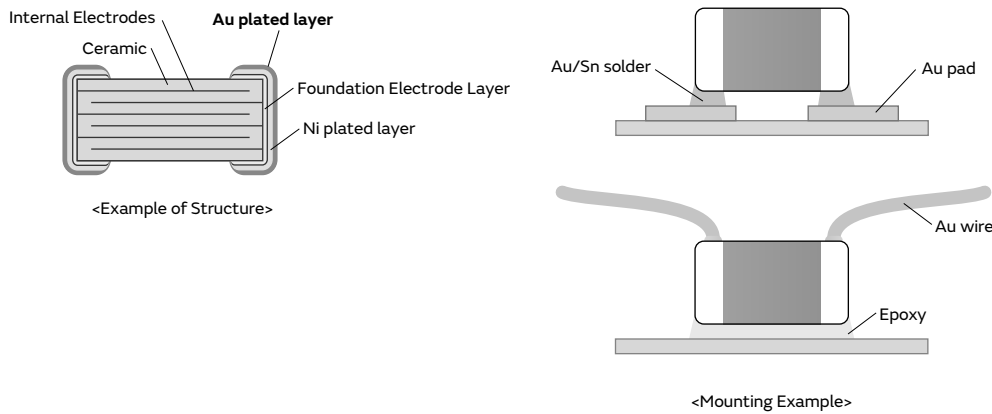

*This product is suitable only for wire bonding or use of gold-tin (AuSn) solder. Other mounting methods should not be used.

② Ideal for mounting in packages, such as optical communication related devices, IC and etc.

Noise can be reduced by eliminating the routing of the wire, and high efficiency can be achieved with a built-in capacitor in the package, such as TO-CAN, IC and etc. by wire bonding mounting.

③ Contributes to the miniaturization of the set.

Murata offers a lineup of small size products, such as the 0603 (0201) and 1005 (0402) in mm (inch).

Specifications

Size (mm)	0.6×0.3mm to 1.0×0.5mm
Rated Voltage	6.3Vdc to 50Vdc
Capacitance	100pF to 1.0μF
Main Applications	Various device related, such as GaAsIC (mounted in IC packages)

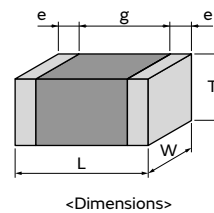

This catalog contains only a portion of the product lineup. Please refer to the capacitor search tool on the Murata Web site for details.

- GRM
- GR3
- GRJ
- GR4
- GJM
- GQM
- GA2
- GA3 GB
- GA3 GD
- GA3 GF
- LLL
- LLA
- LLM
- LLR
- NFM
- KRM
- KR3
- GMA
- GMD
- △Caution / Notice

GMD Series High Dielectric Constant Type Bonding Part Number List

0.6×0.3mm

T max.	Rated Voltage	TC Code	Cap.	Tol.	Part Number	
0.33mm	25Vdc	X7R	100pF	±10%	GMD033R71E101KA01#	
			120pF	±10%	GMD033R71E121KA01#	
			150pF	±10%	GMD033R71E151KA01#	
			180pF	±10%	GMD033R71E181KA01#	
			220pF	±10%	GMD033R71E221KA01#	
			270pF	±10%	GMD033R71E271KA01#	
			330pF	±10%	GMD033R71E331KA01#	
			390pF	±10%	GMD033R71E391KA01#	
			470pF	±10%	GMD033R71E471KA01#	
			560pF	±10%	GMD033R71E561KA01#	
			680pF	±10%	GMD033R71E681KA01#	
			820pF	±10%	GMD033R71E821KA01#	
			1000pF	±10%	GMD033R71E102KA01#	
			1200pF	±10%	GMD033R71E122KA01#	
			1500pF	±10%	GMD033R71E152KA01#	
		R	100pF	±10%	GMD033R11E101KA01#	
			120pF	±10%	GMD033R11E121KA01#	
			150pF	±10%	GMD033R11E151KA01#	
			180pF	±10%	GMD033R11E181KA01#	
			220pF	±10%	GMD033R11E221KA01#	
			270pF	±10%	GMD033R11E271KA01#	
			330pF	±10%	GMD033R11E331KA01#	
			390pF	±10%	GMD033R11E391KA01#	
			470pF	±10%	GMD033R11E471KA01#	
			560pF	±10%	GMD033R11E561KA01#	
			680pF	±10%	GMD033R11E681KA01#	
			820pF	±10%	GMD033R11E821KA01#	
			1000pF	±10%	GMD033R11E102KA01#	
			1200pF	±10%	GMD033R11E122KA01#	
			1500pF	±10%	GMD033R11E152KA01#	
		B	100pF	±10%	GMD033B11E101KA01#	
			120pF	±10%	GMD033B11E121KA01#	
			150pF	±10%	GMD033B11E151KA01#	
			180pF	±10%	GMD033B11E181KA01#	
			220pF	±10%	GMD033B11E221KA01#	
			270pF	±10%	GMD033B11E271KA01#	
			330pF	±10%	GMD033B11E331KA01#	
			390pF	±10%	GMD033B11E391KA01#	
			470pF	±10%	GMD033B11E471KA01#	
			560pF	±10%	GMD033B11E561KA01#	
			680pF	±10%	GMD033B11E681KA01#	
			820pF	±10%	GMD033B11E821KA01#	
			1000pF	±10%	GMD033B11E102KA01#	
			1200pF	±10%	GMD033B11E122KA01#	
			1500pF	±10%	GMD033B11E152KA01#	
	16Vdc	X7R	1800pF	±10%	GMD033R71C182KA11#	
			2200pF	±10%	GMD033R71C222KA11#	
			2700pF	±10%	GMD033R71C272KA11#	
			3300pF	±10%	GMD033R71C332KA11#	
			R	1800pF	±10%	GMD033R11C182KA11#
				2200pF	±10%	GMD033R11C222KA11#
		2700pF		±10%	GMD033R11C272KA11#	
		3300pF		±10%	GMD033R11C332KA11#	

T max.	Rated Voltage	TC Code	Cap.	Tol.	Part Number	
0.33mm	16Vdc	R	3300pF	±10%	GMD033R11C332KA11#	
			B	1800pF	±10%	GMD033B31C182KA11#
			2200pF	±10%	GMD033B31C222KA11#	
			2700pF	±10%	GMD033B31C272KA11#	
		3300pF	±10%	GMD033B31C332KA11#		
		10Vdc	X7R	3900pF	±10%	GMD033R71A392KA01#
				4700pF	±10%	GMD033R71A472KA01#
				5600pF	±10%	GMD033R71A562KA01#
				6800pF	±10%	GMD033R71A682KA01#
				8200pF	±10%	GMD033R71A822KA01#
				10000pF	±10%	GMD033R71A103KA01#
			R	3900pF	±10%	GMD033R11A392KA01#
	4700pF			±10%	GMD033R11A472KA01#	
	5600pF			±10%	GMD033R11A562KA01#	
	6800pF			±10%	GMD033R11A682KA01#	
	6.3Vdc	X5R	5600pF	±10%	GMD033R60J563KE11#	
			6800pF	±10%	GMD033R60J683KE11#	
			8200pF	±10%	GMD033R60J823KE11#	
			0.10μF	±10%	GMD033R60J104KE11#	
		B	5600pF	±10%	GMD033B30J563KE11#	
			6800pF	±10%	GMD033B30J683KE11#	
			8200pF	±10%	GMD033B30J823KE11#	
			0.10μF	±10%	GMD033B30J104KE11#	

1.0×0.5mm

T max.	Rated Voltage	TC Code	Cap.	Tol.	Part Number	
0.55mm	50Vdc	X7R	220pF	±10%	GMD155R71H221KA01#	
			270pF	±10%	GMD155R71H271KA01#	
			330pF	±10%	GMD155R71H331KA01#	
			390pF	±10%	GMD155R71H391KA01#	
			470pF	±10%	GMD155R71H471KA01#	
			560pF	±10%	GMD155R71H561KA01#	
			680pF	±10%	GMD155R71H681KA01#	
			820pF	±10%	GMD155R71H821KA01#	
			1000pF	±10%	GMD155R71H102KA01#	
			1200pF	±10%	GMD155R71H122KA01#	
			1500pF	±10%	GMD155R71H152KA01#	
			1800pF	±10%	GMD155R71H182KA01#	
			2200pF	±10%	GMD155R71H222KA01#	
			2700pF	±10%	GMD155R71H272KA01#	
			3300pF	±10%	GMD155R71H332KA01#	
			3900pF	±10%	GMD155R71H392KA01#	
			4700pF	±10%	GMD155R71H472KA01#	
			R	220pF	±10%	GMD155R11H221KA01#

Part number # indicates the package specification code.

GRM
 GR3
 GRJ
 GR4
 GJM
 GQM
 GA2
 GA3 GB
 GA3 GD
 GA3 GF
 LLL
 LLA
 LLM
 LLR
 NFM
 KRM
 KR3
 GMA
 GMD
 ⚠Caution /Notice

GMD Series High Dielectric Constant Type Bonding Part Number List

(→ 1.0×0.5mm)

T max.	Rated Voltage	TC Code	Cap.	Tol.	Part Number	T max.	Rated Voltage	TC Code	Cap.	Tol.	Part Number	
0.55mm	50Vdc	R	270pF	±10%	GMD155R11H271KA01#	0.55mm	25Vdc	R	33000pF	±10%	GMD155R11E333KA11#	
			330pF	±10%	GMD155R11H331KA01#				39000pF	±10%	GMD155R11E393KA11#	
			390pF	±10%	GMD155R11H391KA01#				47000pF	±10%	GMD155R11E473KA11#	
			470pF	±10%	GMD155R11H471KA01#				B	5600pF	±10%	GMD155B11E562KA01#
			560pF	±10%	GMD155R11H561KA01#					6800pF	±10%	GMD155B11E682KA01#
			680pF	±10%	GMD155R11H681KA01#					8200pF	±10%	GMD155B11E822KA01#
			820pF	±10%	GMD155R11H821KA01#					10000pF	±10%	GMD155B11E103KA01#
			1000pF	±10%	GMD155R11H102KA01#					12000pF	±10%	GMD155B11E123KA01#
			1200pF	±10%	GMD155R11H122KA01#					15000pF	±10%	GMD155B11E153KA01#
			1500pF	±10%	GMD155R11H152KA01#				18000pF	±10%	GMD155B11E183KA01#	
			1800pF	±10%	GMD155R11H182KA01#				22000pF	±10%	GMD155B11E223KA01#	
			2200pF	±10%	GMD155R11H222KA01#				27000pF	±10%	GMD155B31E273KA11#	
			2700pF	±10%	GMD155R11H272KA01#				33000pF	±10%	GMD155B31E333KA11#	
			3300pF	±10%	GMD155R11H332KA01#				39000pF	±10%	GMD155B31E393KA11#	
			3900pF	±10%	GMD155R11H392KA01#			47000pF	±10%	GMD155B31E473KA11#		
			4700pF	±10%	GMD155R11H472KA01#			16Vdc	X7R	56000pF	±10%	GMD155R71C563KA11#
			5600pF	±10%	GMD155B11H561KA01#					68000pF	±10%	GMD155R71C683KA11#
			6800pF	±10%	GMD155R11H681KA01#					82000pF	±10%	GMD155R71C823KA11#
			8200pF	±10%	GMD155R11H821KA01#				R	0.10μF	±10%	GMD155R71C104KA11#
			10000pF	±10%	GMD155R11H102KA01#					56000pF	±10%	GMD155R11C563KA11#
			12000pF	±10%	GMD155R11H122KA01#					68000pF	±10%	GMD155R11C683KA11#
			15000pF	±10%	GMD155R11H152KA01#				82000pF	±10%	GMD155R11C823KA11#	
			18000pF	±10%	GMD155R11H182KA01#				B	0.10μF	±10%	GMD155R11C104KA11#
			22000pF	±10%	GMD155R11H222KA01#					56000pF	±10%	GMD155B31C563KA11#
			27000pF	±10%	GMD155R11H272KA01#					68000pF	±10%	GMD155B31C683KA11#
			33000pF	±10%	GMD155R11H332KA01#			82000pF		±10%	GMD155B31C823KA11#	
			39000pF	±10%	GMD155R11H392KA01#			10Vdc	X5R	0.12μF	±10%	GMD155R61A124KE12#
	47000pF	±10%	GMD155R11H472KA01#	0.15μF	±10%		GMD155R61A154KE12#					
	5600pF	±10%	GMD155R71E562KA01#	0.18μF	±10%		GMD155R61A184KE12#					
	6800pF	±10%	GMD155R71E682KA01#	0.22μF	±10%		GMD155R61A224KE12#					
	8200pF	±10%	GMD155R71E822KA01#	0.27μF	±10%		GMD155R61A274KE11# D1					
	10000pF	±10%	GMD155R71E103KA01#	0.33μF	±10%		GMD155R61A334KE11# D1					
	12000pF	±10%	GMD155R71E123KA01#	0.39μF	±10%		GMD155R61A394KE11# D1					
	15000pF	±10%	GMD155R71E153KA01#	0.47μF	±10%		GMD155R61A474KE11# D1					
	18000pF	±10%	GMD155R71E183KA01#	B	0.12μF		±10%		GMD155B31A124KE12#			
	22000pF	±10%	GMD155R71E223KA01#		0.15μF		±10%		GMD155B31A154KE12#			
	27000pF	±10%	GMD155R71E273KA11#		0.18μF		±10%	GMD155B31A184KE12#				
	33000pF	±10%	GMD155R71E333KA11#		0.22μF		±10%	GMD155B31A224KE12#				
	39000pF	±10%	GMD155R71E393KA11#	0.27μF	±10%		GMD155B31A274KE11# D1					
	47000pF	±10%	GMD155R71E473KA11#	0.33μF	±10%		GMD155B31A334KE11# D1					
	25Vdc	X7R	5600pF	±10%	GMD155R71E562KA01#		0.39μF	±10%	GMD155B31A394KE11# D1			
			6800pF	±10%	GMD155R71E682KA01#		0.47μF	±10%	GMD155B31A474KE11# D1			
			8200pF	±10%	GMD155R71E822KA01#		R	0.12μF	±10%	GMD155R11E562KA01#		
			10000pF	±10%	GMD155R71E103KA01#			6800pF	±10%	GMD155R11E682KA01#		
			12000pF	±10%	GMD155R71E123KA01#			8200pF	±10%	GMD155R11E822KA01#		
			15000pF	±10%	GMD155R71E153KA01#			10000pF	±10%	GMD155R11E103KA01#		
			18000pF	±10%	GMD155R71E183KA01#			12000pF	±10%	GMD155R11E123KA01#		
22000pF			±10%	GMD155R71E223KA01#	15000pF	±10%		GMD155R11E153KA01#				
27000pF			±10%	GMD155R71E273KA11#	18000pF	±10%		GMD155R11E183KA01#				
33000pF			±10%	GMD155R71E333KA11#	22000pF	±10%	GMD155R11E223KA01#					
39000pF			±10%	GMD155R71E393KA11#	27000pF	±10%	GMD155R11E273KA11#					
47000pF			±10%	GMD155R71E473KA11#	R	5600pF	±10%	GMD155R11E562KA01#				
5600pF			±10%	GMD155R11E562KA01#		6800pF	±10%	GMD155R11E682KA01#				
6800pF	±10%	GMD155R11E682KA01#	8200pF	±10%		GMD155R11E822KA01#						
8200pF	±10%	GMD155R11E822KA01#	10000pF	±10%		GMD155R11E103KA01#						
10000pF	±10%	GMD155R11E103KA01#	12000pF	±10%		GMD155R11E123KA01#						
12000pF	±10%	GMD155R11E123KA01#	15000pF	±10%		GMD155R11E153KA01#						
15000pF	±10%	GMD155R11E153KA01#	18000pF	±10%	GMD155R11E183KA01#							
18000pF	±10%	GMD155R11E183KA01#	22000pF	±10%	GMD155R11E223KA01#							
22000pF	±10%	GMD155R11E223KA01#	27000pF	±10%	GMD155R11E273KA11#							
27000pF	±10%	GMD155R11E273KA11#										

- GRM
- GR3
- GRJ
- GR4
- GJM
- GQM
- GA2
- GA3 GB
- GA3 GD
- GA3 GF
- LLL
- LLA
- LLM
- LLR
- NFM
- KRM
- KR3
- GMA
- GMD
- ⚠Caution /Notice

Part number # indicates the package specification code.

⚠️Caution/Notice

WEB 

Target series: GRM, GR3, GRJ, GR4, GJM, GQM, GA2, GA3, LLL, LLA, LLM, LLR, NFM, KRM, KR3, GMA, GMD

⚠️Caution

Notice

Storage and Operation Conditions	126
Rating	126
1. Temperature Dependent Characteristics	126
2. Measurement of Capacitance	126
3. Applied Voltage and Applied Current	127
4. Type of Applied Voltage and Self-heating Temperature	127
5. DC Voltage and AC Voltage Characteristics	130
6. Capacitance Aging	130
7. Vibration and Shock	131
Soldering and Mounting	131
1. Mounting Position	131
2. Information before Mounting	132
3. Maintenance of the Mounting (pick and place) Machine	132
4-1. Reflow Soldering	133
4-2. Flow Soldering	135
4-3. Correction of Soldered Portion	136
5. Washing	137
6. Electrical Test on Printed Circuit Board	137
7. Printed Circuit Board Cropping	137
8. Assembly	140
9. Die Bonding/Wire Bonding	141
Other	141
1. Under Operation of Equipment	141
2. Other	142

Rating	143
1. Operating Temperature	143
2. Atmosphere Surroundings (gaseous and liquid)	143
3. Piezo-electric Phenomenon	143
Soldering and Mounting	143
1. PCB Design	143
1. Notice for Pattern Forms	143
2. Land Dimensions	144
3. Board Design	148
2. Item to be confirmed for Flow soldering	148
3. Reflow Soldering	149
4. Washing	149
5. Coating	150
Other	150
1. Transportation	150
2. Characteristics Evaluation in the Actual System	150

- GRM
- GR3
- GRJ
- GR4
- GJM
- GQM
- GA2
- GA3 GB
- GA3 GD
- GA3 GF
- LLL
- LLA
- LLM
- LLR
- NFM
- KRM
- KR3
- GMA
- GMD
- ⚠️Caution / Notice

⚠Caution

Storage and Operation Conditions

1. The performance of chip multilayer ceramic capacitors and chip EMIFIL NFM series (henceforth just “capacitors”) may be affected by the storage conditions.

Please use them promptly after delivery.

1-1. Maintain appropriate storage for the capacitors using the following conditions: Room Temperature of +5 to +40°C and a Relative Humidity of 20 to 70%.

High temperature and humidity conditions and/or prolonged storage may cause deterioration of the packaging materials. If more than six months have elapsed since delivery, check packaging, mounting, etc. before use.

In addition, this may cause oxidation of the electrodes. If more than one year has elapsed since delivery, also check the solderability before use.

1-2. Corrosive gas can react with the termination (external) electrodes or lead wires of capacitors, and result in poor solderability. Do not store the capacitors in an atmosphere consisting of corrosive gas (e.g., hydrogen sulfide, sulfur dioxide, chlorine, ammonia gas, etc.).

1-3. Due to moisture condensation caused by rapid humidity changes, or the photochemical change caused by direct sunlight on the terminal electrodes and/or the resin/epoxy coatings, the solderability and electrical performance may deteriorate. Do not store capacitors under direct sunlight or in high humidity conditions.

<Applicable to GXM Series>

The water repellency of capacitor surface may reduce when the capacitor is exposed to high temperature for long periods of time. Be sure to confirm if the desired performance can be acquired in actual use conditions and the actual system.

Rating

1. Temperature Dependent Characteristics

1. The electrical characteristics of a capacitor can change with temperature.

1-1. For capacitors having larger temperature dependency, the capacitance may change with temperature changes.

The following actions are recommended in order to ensure suitable capacitance values.

(1) Select a suitable capacitance for the operating temperature range.

(2) The capacitance may change within the rated temperature.

When you use a high dielectric constant type capacitor in a circuit that needs a tight (narrow) capacitance tolerance (e.g., a time-constant circuit), please carefully consider the temperature characteristics, and carefully confirm the various characteristics in actual use conditions and the actual system.

[Example of Temperature Characteristics X7R (R7)]
 Sample: 0.1μF, Rated Voltage 50VDC

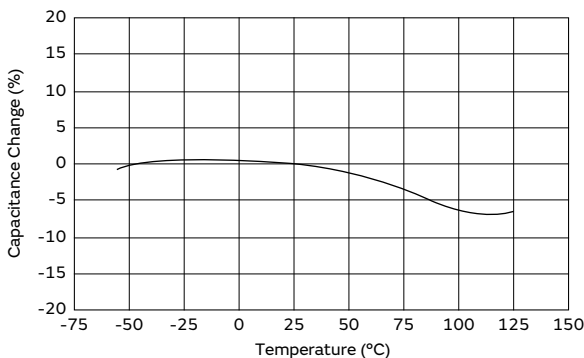

[Example of Temperature Characteristics X5R (R6)]
 Sample: 22μF, Rated Voltage 4VDC

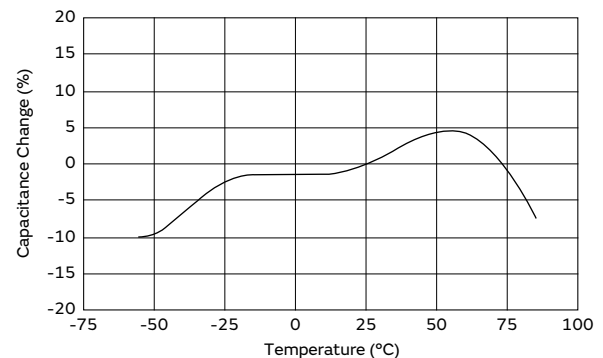

2. Measurement of Capacitance

1. Measure capacitance with the voltage and frequency specified in the product specifications.

1-1. The output voltage of the measuring equipment may decrease occasionally when capacitance is high. Please confirm whether a prescribed measured voltage is impressed to the capacitor.

1-2. The capacitance values of high dielectric constant type capacitors change depending on the AC voltage applied. Please consider the AC voltage characteristics when selecting a capacitor to be used in an AC circuit.

Continued on the following page. ↗

Caution

Continued from the preceding page. ↘

3. Applied Voltage and Applied Current

1. Do not apply a voltage to the capacitor that exceeds the rated voltage as called out in the specifications.
 - 1-1. Applied voltage between the terminals of a capacitor shall be less than or equal to the rated voltage.
 - (1) When AC voltage is superimposed on DC voltage, the zero-to-peak voltage shall not exceed the rated DC voltage.
 When AC voltage or pulse voltage is applied, the peak-to-peak voltage shall not exceed the rated DC voltage.
 - (2) Abnormal voltages (surge voltage, static electricity, pulse voltage, etc.) shall not exceed the rated DC voltage.

Typical Voltage Applied to the DC Capacitor

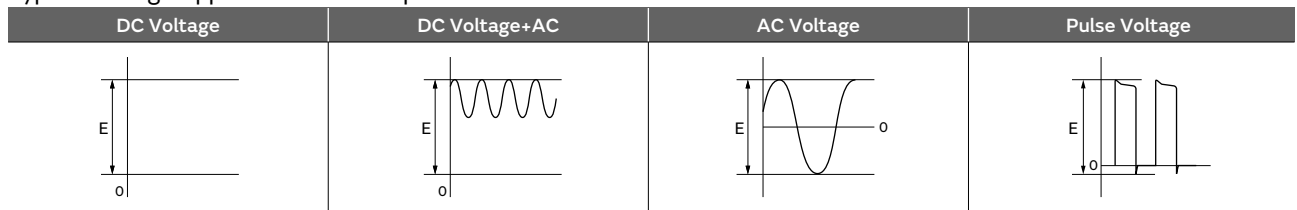

(E: Maximum possible applied voltage.)

- 1-2. Influence of over voltage
 Over voltage that is applied to the capacitor may result in an electrical short circuit caused by the breakdown of the internal dielectric layers. The time duration until breakdown depends on the applied voltage and the ambient temperature.
2. Use a safety standard certified capacitor in a power supply input circuit (AC filter), as it is also necessary to consider the withstand voltage and impulse withstand voltage defined for each device.

<Applicable to NFM Series>

3. The capacitors also have rated currents.
 The current flowing between the terminals of a capacitor shall be less than or equal to the rated current. Using the capacitor beyond this range could lead to excessive heat.

4. Type of Applied Voltage and Self-heating Temperature

1. Confirm the operating conditions to make sure that no large current is flowing into the capacitor due to the continuous application of an AC voltage or pulse voltage.
 When a DC rated voltage product is used in an AC voltage circuit or a pulse voltage circuit, the AC current or pulse current will flow into the capacitor; therefore check the self-heating condition.
 Please confirm the surface temperature of the capacitor so that the temperature remains within the upper limits of the operating temperature, including the rise in temperature due to self-heating. When the capacitor is used with a high-frequency voltage or pulse voltage, heat may be generated by dielectric loss.
<Applicable to Rated Voltage of less than 100VDC>
 - 1-1. The load should be contained so that the self-heating of the capacitor body remains below 20°C, when measuring at an ambient temperature of 25°C.

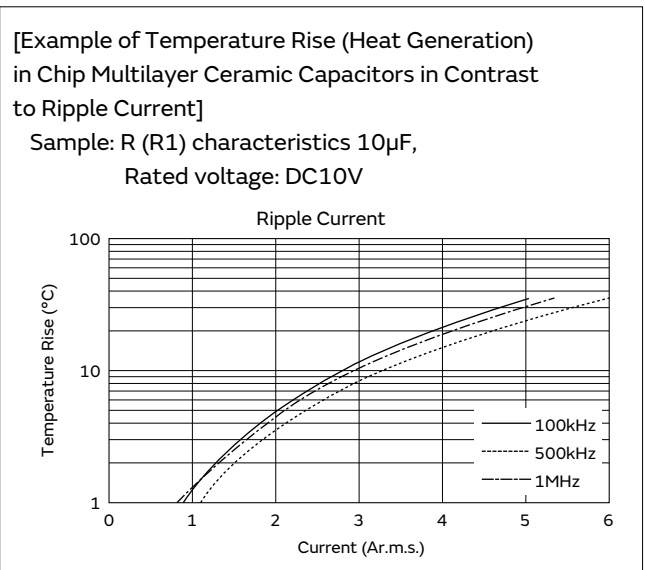

Continued on the following page. ↗

⚠Caution

Continued from the preceding page. ↘

<Applicable to Temperature Characteristics X7R (R7), X7T (D7), X7T (W0) beyond Rated Voltage of 200VDC>

1-2. The load should be contained so that the self-heating of the capacitor body remains below 20°C, when measuring at an ambient temperature of 25°C. In addition, use a K thermocouple of $\varnothing 0.1\text{mm}$ with less heat capacity when measuring, and measure in a condition where there is no effect from the radiant heat of other components or air flow caused by convection. Excessive generation of heat may cause deterioration of the characteristics and reliability of the capacitor. (Absolutely do not perform measurements while the cooling fan is operating, as an accurate measurement may not be performed.)

<Applicable to Temperature Characteristics U2J (7U), COG (5C) beyond Rated Voltage of 200VDC>

1-3. Since the self-heating is low in the low loss series, the allowable power becomes extremely high compared to the common X7R (R7) characteristics. However, when a load with self-heating of 20°C is applied at the rated voltage, the allowable power may be exceeded. When the capacitor is used in a high-frequency voltage circuit of 1kHz or more, the frequency of the applied voltage should be less than 500kHz sine wave (less than 100kHz for a product with rated voltage of DC3.15kV), to limit the voltage load so that the load remains within the derating shown in the following figure. In the case of non-sine wave, high-frequency components exceeding the fundamental frequency may be included. In such a case, please contact Murata. The excessive generation of heat may cause deterioration of the characteristics and reliability of the capacitor. (Absolutely do not perform measurements while the cooling fan is operating, as an accurate measurement may not be performed.)

[The sine-wave frequency VS allowable voltage]

The surface temperature of the capacitor: 125°C or less (including self-heating)

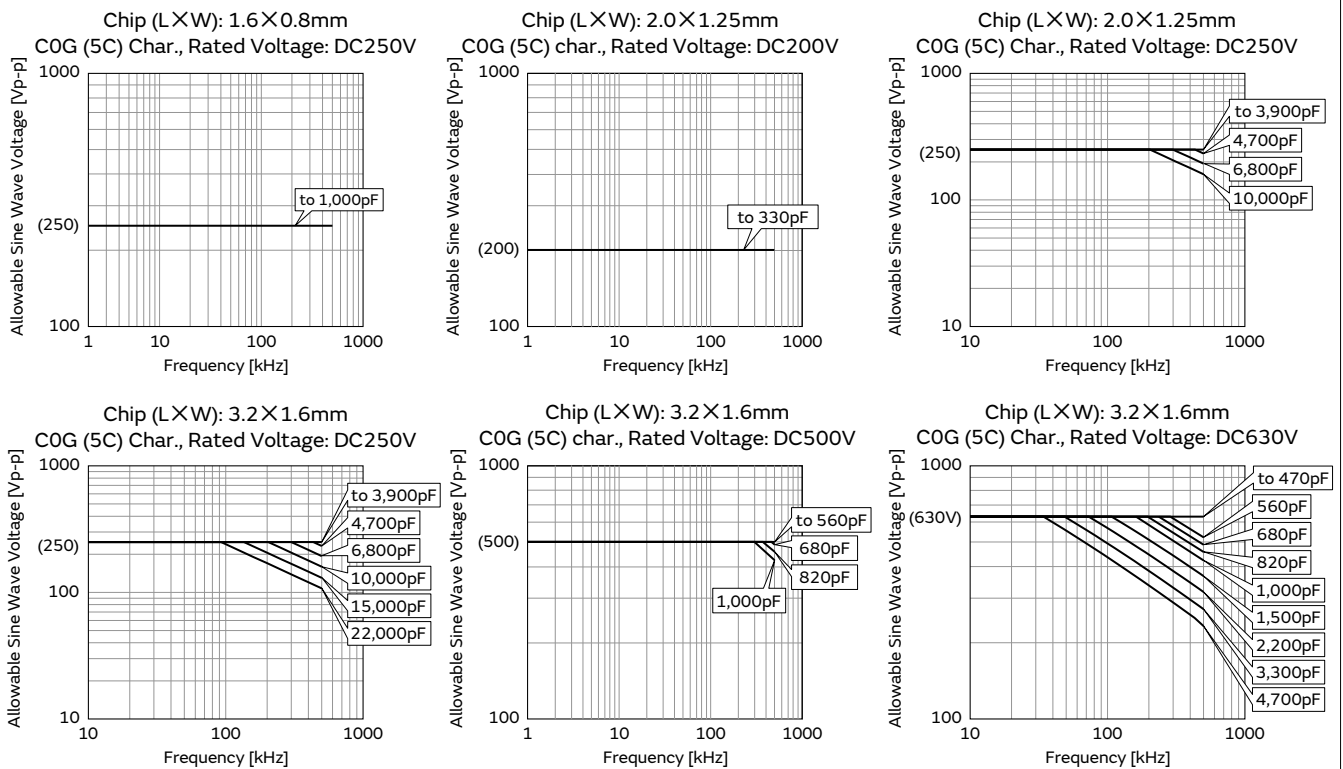

Continued on the following page. ↗

GRM
 GR3
 GRJ
 GR4
 GJM
 GQM
 GA2
 GA3 GB
 GA3 GD
 GA3 GF
 LLL
 LLA
 LLM
 LLR
 NFM
 KRM
 KR3
 GMA
 GMD
 ⚠Caution

⚠️Caution

Continued from the preceding page. ↘

[The sine-wave frequency VS allowable voltage]

The surface temperature of the capacitor: 125°C or less
 (including self-heating)

The capacitors less than 22pF can be applied maximum 4.0kV peak to peak at 100kHz or less only for the ballast or the resonance usage in the CFL inverter circuit.

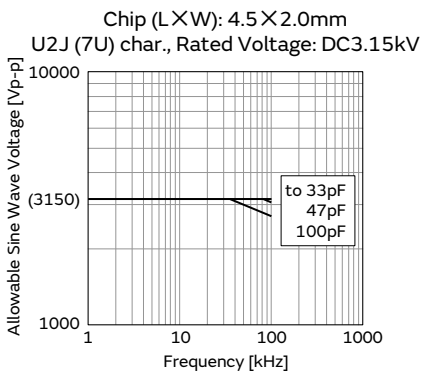
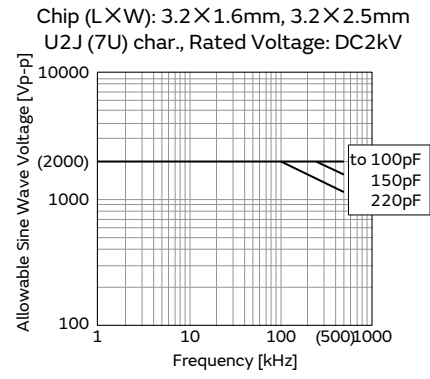
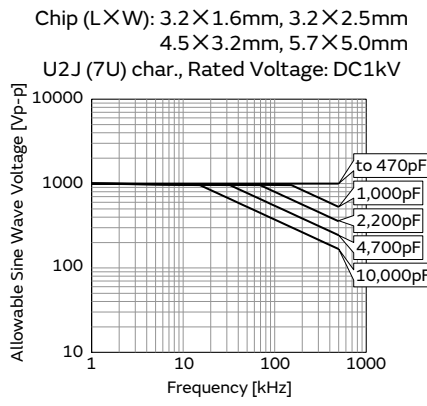
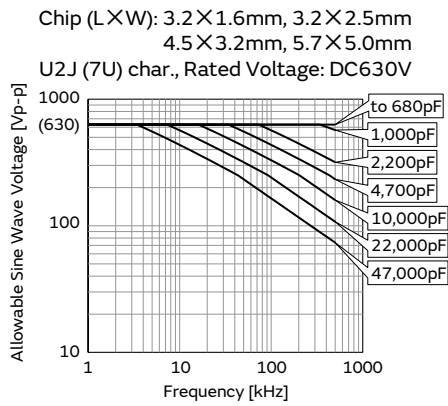
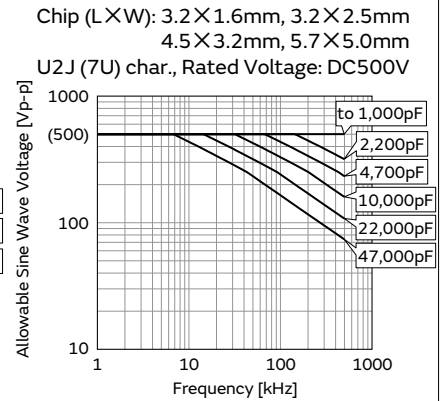
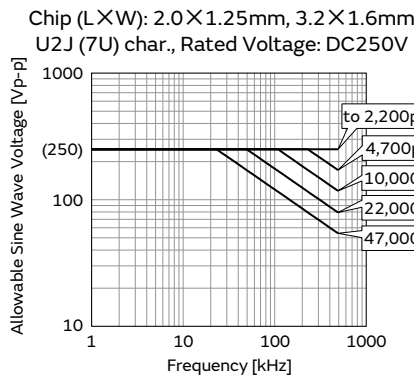
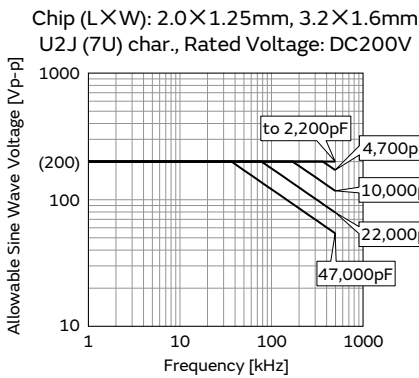
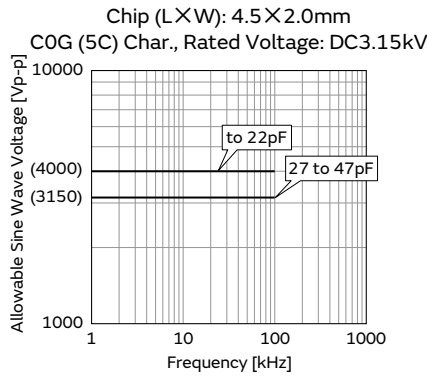
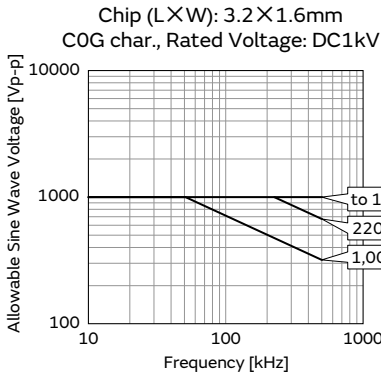

Continued on the following page. ↗

GRM
 GR3
 GRJ
 GR4
 GJM
 GQM
 GA2
 GA3 GB
 GA3 GD
 GA3 GF
 LLL
 LLA
 LLM
 LLR
 NFM
 KRM
 KR3
 GMA
 GMD
 ⚠️Caution

⚠Caution

Continued from the preceding page. ↘

5. DC Voltage and AC Voltage Characteristics

1. The capacitance value of a high dielectric constant type capacitor changes depending on the DC voltage applied. Please consider the DC voltage characteristics when a capacitor is selected for use in a DC circuit.

1-1. The capacitance of ceramic capacitors may change sharply depending on the applied voltage (see figure). Please confirm the following in order to secure the capacitance.

- (1) Determine whether the capacitance change caused by the applied voltage is within the allowed range.
- (2) In the DC voltage characteristics, the rate of capacitance change becomes larger as voltage increases, even if the applied voltage is below the rated voltage. When a high dielectric constant type capacitor is used in a circuit that requires a tight (narrow) capacitance tolerance (e.g., a time constant circuit), please carefully consider the voltage characteristics, and confirm the various characteristics in the actual operating conditions of the system.

2. The capacitance values of high dielectric constant type capacitors changes depending on the AC voltage applied. Please consider the AC voltage characteristics when selecting a capacitor to be used in an AC circuit.

[Example of DC Voltage Characteristics]
 Sample: X7R (R7) Characteristics 0.1μF,
 Rated Voltage 50VDC

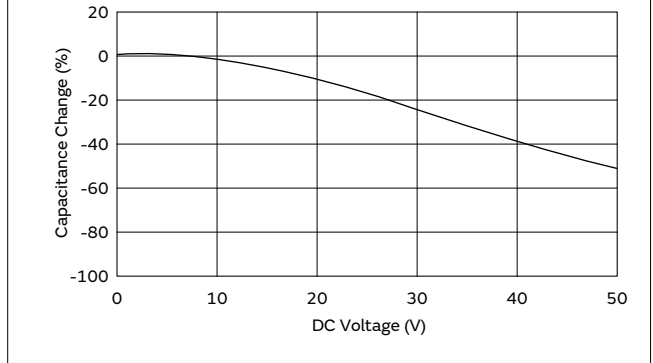

[Example of AC Voltage Characteristics]
 Sample: X7R (R7) Characteristics 10μF,
 Rated Voltage 6.3VDC

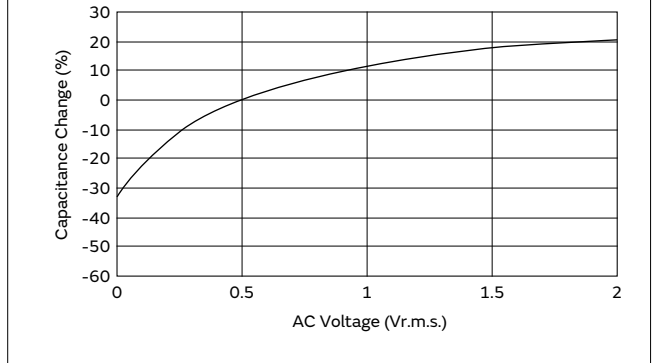

6. Capacitance Aging

1. The high dielectric constant type capacitors have an Aging characteristic in which the capacitance value decreases with the passage of time. When you use high dielectric constant type capacitors in a circuit that needs a tight (narrow) capacitance tolerance (e.g., a time-constant circuit), please carefully consider the characteristics of these capacitors, such as their aging, voltage, and temperature characteristics. In addition, check capacitors using your actual appliances at the intended environment and operating conditions.

[Example of Change Over Time (Aging Characteristics)]

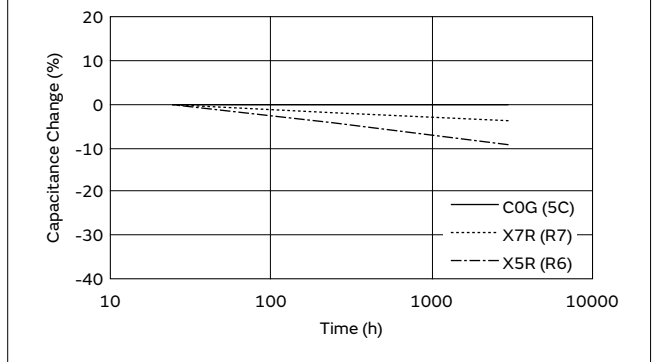

Continued on the following page. ↗

GRM

GR3

GRJ

GR4

GJM

GQM

GA2

GA3 GB

GA3 GD

GA3 GF

LLL

LLA

LLM

LLR

NFM

KRM

KR3

GMA

GMD

⚠Caution

⚠Caution

⚠Caution

Continued from the preceding page. ↘

7. Vibration and Shock

1. Please confirm the kind of vibration and/or shock, its condition, and any generation of resonance.
 Please mount the capacitor so as not to generate resonance, and do not allow any impact on the terminals.
2. Mechanical shock due to being dropped may cause damage or a crack in the dielectric material of the capacitor.
 Do not use a dropped capacitor because the quality and reliability may be deteriorated.
3. When printed circuit boards are piled up or handled, the corner of another printed circuit board should not be allowed to hit the capacitor, in order to avoid a crack or other damage to the capacitor.

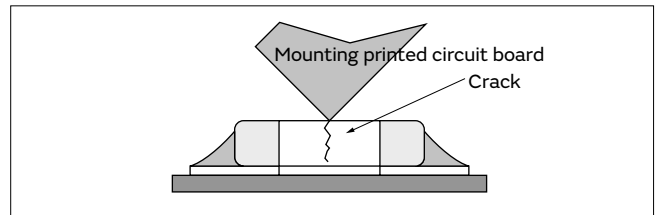
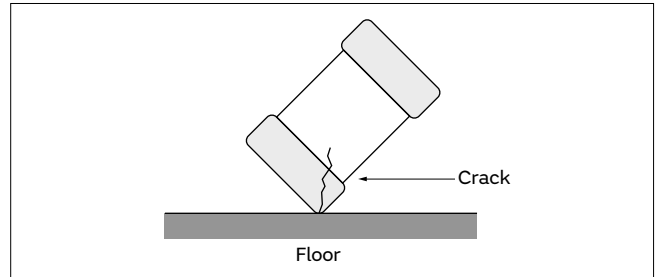

Soldering and Mounting

1. Mounting Position

1. Confirm the best mounting position and direction that minimizes the stress imposed on the capacitor during flexing or bending the printed circuit board.
 - 1-1. Choose a mounting position that minimizes the stress imposed on the chip during flexing or bending of the board.

<Applicable to NFM Series>

2. If you mount the capacitor near components that generate heat, take note of the heat from the other components and carefully check the self-heating of the capacitor before using.
 If there is significant heat radiation from other components, it could lower the insulation resistance of the capacitor or produce excessive heat.

[Component Direction]

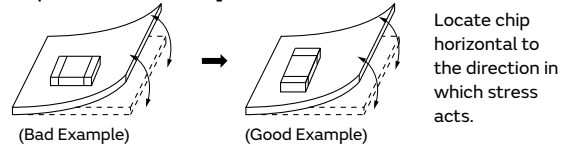

[Chip Mounting Close to Board Separation Point]

It is effective to implement the following measures, to reduce stress in separating the board.
 It is best to implement all of the following three measures; however, implement as many measures as possible to reduce stress.

Contents of Measures	Stress Level
(1) Turn the mounting direction of the component parallel to the board separation surface.	A > D *1
(2) Add slits in the board separation part.	A > B
(3) Keep the mounting position of the component away from the board separation surface.	A > C

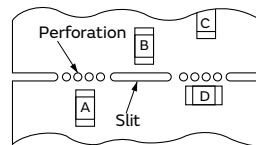

*1 A > D is valid when stress is added vertically to the perforation as with Hand Separation.
 If a Cutting Disc is used, stress will be diagonal to the PCB, therefore A > D is invalid.

[Mounting Capacitors Near Screw Holes]

When a capacitor is mounted near a screw hole, it may be affected by the board deflection that occurs during the tightening of the screw. Mount the capacitor in a position as far away from the screw holes as possible.

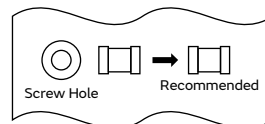

Continued on the following page. ↗

GRM
 GR3
 GRJ
 GR4
 GJM
 GQM
 GA2
 GA3 GB
 GA3 GD
 GA3 GF
 LLL
 LLA
 LLM
 LLR
 NFM
 KRM
 KR3
 GMA
 GMD
 ⚠Caution

⚠Caution

Continued from the preceding page. ↘

2. Information before Mounting

1. Do not re-use capacitors that were removed from the equipment.
2. Confirm capacitance characteristics under actual applied voltage.
3. Confirm the mechanical stress under actual process and equipment use.
4. Confirm the rated capacitance, rated voltage and other electrical characteristics before assembly.
5. Prior to use, confirm the solderability of capacitors that were in long-term storage.
6. Prior to measuring capacitance, carry out a heat treatment for capacitors that were in long-term storage.
7. The use of Sn-Zn based solder will deteriorate the reliability of the MLCC.
Please contact our sales representative or product engineers on the use of Sn-Zn based solder in advance.
8. We have also produced a DVD which shows a summary of our recommendations, regarding the precautions for mounting. Please contact our sales representative to request the DVD.

3. Maintenance of the Mounting (pick and place) Machine

1. Make sure that the following excessive forces are not applied to the capacitors. Check the mounting in the actual device under actual use conditions ahead of time.
 - 1-1. In mounting the capacitors on the printed circuit board, any bending force against them shall be kept to a minimum to prevent them from any damage or cracking. Please take into account the following precautions and recommendations for use in your process.
 - (1) Adjust the lowest position of the pickup nozzle so as not to bend the printed circuit board.
 2. Dirt particles and dust accumulated in the suction nozzle and suction mechanism prevent the nozzle from moving smoothly. This creates excessive force on the capacitor during mounting, causing cracked chips. Also, the locating claw, when worn out, imposes uneven forces on the chip when positioning, causing cracked chips. The suction nozzle and the locating claw must be maintained, checked, and replaced periodically.
- <Applicable to ZRA/ZRB Series>
3. To adjust the inspection tolerance for automated appearance sorting machine of mounting position, because ZRA/ZRB series are easier to shift the mounting position than standard MLCC.
 4. To check the overturn and reverse of chip.
 5. To control mounting speed carefully, because ZRA/ZRB series is heavier than standard MLCC.

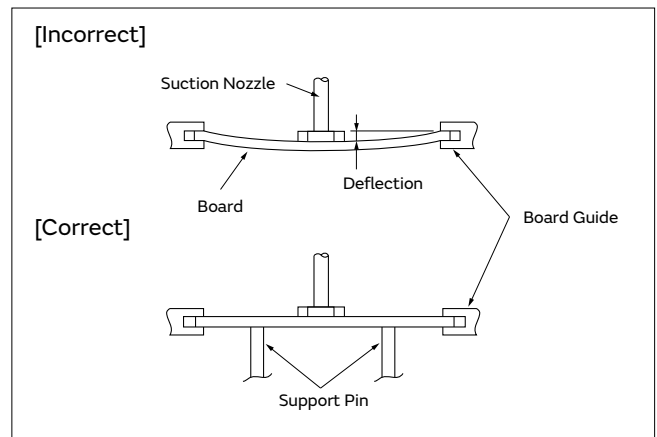

Continued on the following page. ↗

⚠Caution

Continued from the preceding page. ↘

4-1. Reflow Soldering

1. When sudden heat is applied to the components, the mechanical strength of the components will decrease because a sudden temperature change causes deformation inside the components. In order to prevent mechanical damage to the components, preheating is required for both the components and the PCB. Preheating conditions are shown in table 1. It is required to keep the temperature differential between the solder and the components surface (ΔT) as small as possible.
2. When components are immersed in solvent after mounting, be sure to maintain the temperature difference (ΔT) between the component and the solvent within the range shown in table 1.

Table 1

Series	Chip Dimension Code (L/W)	Temperature Differential
GRM/GRJ/GXM/GR4/GJM/GQM/LLR/NFM/GJ4/ZRA/ZRB/KRM	01/02/MD/03/15/18/JN/21/31	$\Delta T \leq 190^\circ\text{C}$
LLL	02/03/15/18/1U/21/31	
GRM/GR3/GRJ/GXM/GR4/GA2/GA3/KRM/KR3	32/42/43/52/55	$\Delta T \leq 130^\circ\text{C}$
LLA/LLM	18/21/31	
GQM	22	

Recommended Conditions

	Pb-Sn Solder	Lead Free Solder
Peak Temperature	230 to 250°C	240 to 260°C
Atmosphere	Air	Air or N ₂

Pb-Sn Solder: Sn-37Pb

Lead Free Solder: Sn-3.0Ag-0.5Cu

3. When a capacitor is mounted at a temperature lower than the peak reflow temperature recommended by the solder manufacturer, the following quality problems can occur. Consider factors such as the placement of peripheral components and the reflow temperature setting to prevent the capacitor's reflow temperature from dropping below the peak temperature specified. Be sure to evaluate the mounting situation beforehand and verify that none of the following problems occur.

- Drop in solder wettability
- Solder voids
- Possible occurrence of whiskering
- Drop in bonding strength
- Drop in self-alignment properties
- Possible occurrence of tombstones and/or shifting on the land patterns of the circuit board

[Example of Temperature Conditions for Reflow Soldering]

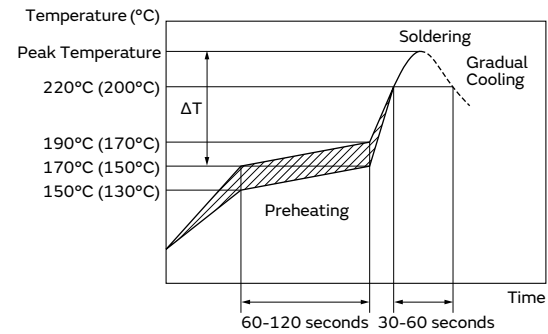

Temperature
 Incase of Lead Free Solder
 (): In case of Pb-Sn Solder

[Allowable Reflow Soldering Temperature and Time]

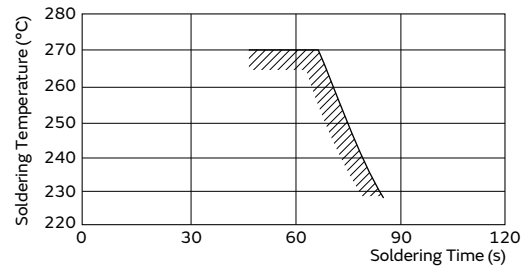

In the case of repeated soldering, the accumulated soldering time must be within the range shown above.

Continued on the following page. ↗

- GRM
- GR3
- GRJ
- GR4
- GJM
- GQM
- GA2
- GA3
- GA3
- GA3
- GA3
- LLL
- LLA
- LLM
- LLR
- NFM
- KRM
- KR3
- GMA
- GMD

⚠Caution

⚠Caution

Continued from the preceding page. ↘

4. Optimum Solder Amount for Reflow Soldering

- 4-1. Overly thick application of solder paste results in a excessive solder fillet height.
 This makes the chip more susceptible to mechanical and thermal stress on the board and may cause the chips to crack.
- 4-2. Too little solder paste results in a lack of adhesive strength on the termination, which may result in chips breaking loose from the PCB.
- 4-3. Please confirm that solder has been applied smoothly to the termination. (Only ZRA/ZRB Series: The solder applied to the end surface of chip may cause loss suppress acoustic noise.)

<Applicable to NFM Series>

[Guideline of solder paste thickness]
 100-150 μ m: NFM15/18/21/3D/31
 100-200 μ m: NFM41

NFM15CC/15PC

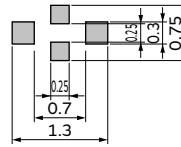

NFMJMPC

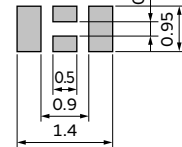

NFM18CC/18PC

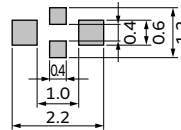

NFM18PS

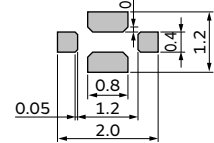

NFM21CC/21PC

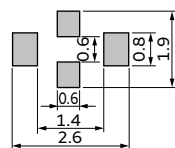

NFM21PS

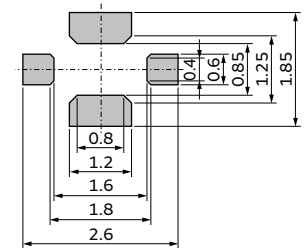

NFM3DCC/3DPC

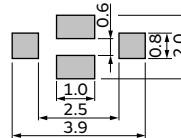

NFM31PC/31KC

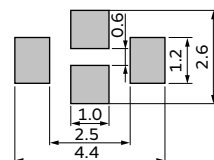

NFM41CC/41PC

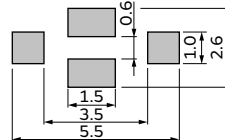

Inverting the PCB

Make sure not to impose any abnormal mechanical shocks to the PCB.

Continued on the following page. ↗

- GRM
- GR3
- GRJ
- GR4
- GJM
- GQM
- GA2
- GA3 GB
- GA3 GD
- GA3 GF
- LLL
- LLA
- LLM
- LLR
- NFM
- KRM
- KR3
- GMA
- GMD
- ⚠Caution

Caution

Continued from the preceding page. ↘

4-2. Flow Soldering

1. Do not apply flow soldering to chips not listed in table 2.

Table 2

Series	Chip Dimension Code (L/W)	Temperature Differential
GRM	18/21/31	$\Delta T \leq 150^{\circ}\text{C}$
GQM	18/21	
LLL	21/31	
GRJ	18/21/31	
NFM	3D/31/41	

- When sudden heat is applied to the components, the mechanical strength of the components will decrease because a sudden temperature change causes deformation inside the components. In order to prevent mechanical damage to the components, preheating is required for both of the components and the PCB. Preheating conditions are shown in table 2. It is required to keep the temperature differential between the solder and the components surface (ΔT) as low as possible.
- Excessively long soldering time or high soldering temperature can result in leaching of the terminations, causing poor adhesion or a reduction in capacitance value due to loss of contact between the inner electrodes and terminations.
- When components are immersed in solvent after mounting, be sure to maintain the temperature differential (ΔT) between the component and solvent within the range shown in the table 2.

Recommended Conditions

	Pb-Sn Solder	Lead Free Solder
Preheating Peak Temperature	90 to 110°C	100 to 120°C 140 to 160°C (NFM)
Soldering Peak Temperature	240 to 250°C	250 to 260°C
Atmosphere	Air	Air or N ₂

Pb-Sn Solder: Sn-37Pb

Lead Free Solder: Sn-3.0Ag-0.5Cu

5. Optimum Solder Amount for Flow Soldering

- The top of the solder fillet should be lower than the thickness of the components. If the solder amount is excessive, the risk of cracking is higher during board bending or any other stressful condition.

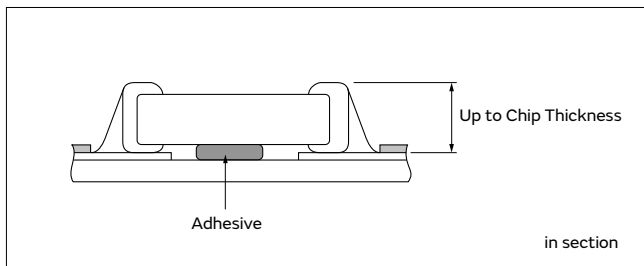

[Example of Temperature Conditions for Flow Soldering]

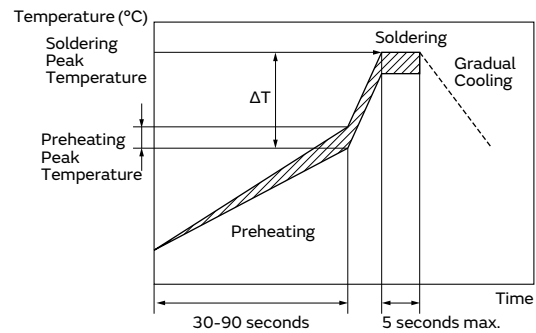

[Allowable Flow Soldering Temperature and Time]

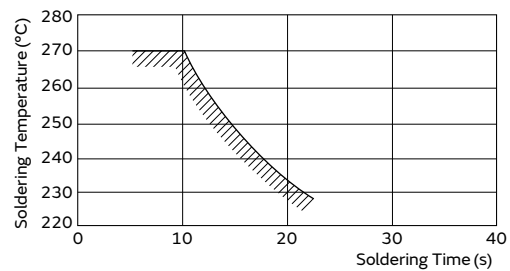

In the case of repeated soldering, the accumulated soldering time must be within the range shown above.

Continued on the following page. ↗

- GRM
- GR3
- GRJ
- GR4
- GJM
- GQM
- GA2
- GA3 GB
- GA3 GD
- GA3 GF
- LLL
- LLA
- LLM
- LLR
- NFM
- KRM
- KR3
- GMA
- GMD
- Caution

⚠Caution

Continued from the preceding page. ↘

4-3. Correction of Soldered Portion

When sudden heat is applied to the capacitor, distortion caused by the large temperature difference occurs internally, and can be the cause of cracks. Capacitors also tend to be affected by mechanical and thermal stress depending on the board preheating temperature or the soldering fillet shape, and can be the cause of cracks. Please refer to "1. PCB Design" or "3. Optimum solder amount" for the solder amount and the fillet shapes.

Do not correct with a soldering iron for ZRA/ZRB series. Correction with a soldering iron for ZRA/ZRB series may cause loss suppress acoustic noise, because the solder amount become excessive.

1. Correction with a Soldering Iron

- 1-1. In order to reduce damage to the capacitor, be sure to preheat the capacitor and the mounting board. Preheat to the temperature range shown in Table 3. A hot plate, hot air type preheater, etc. can be used for preheating.
- 1-2. After soldering, do not allow the component/PCB to cool down rapidly.
- 1-3. Perform the corrections with a soldering iron as quickly as possible. If the soldering iron is applied too long, there is a possibility of causing solder leaching on the terminal electrodes, which will cause deterioration of the adhesive strength and other problems.

Table 3

Series	Chip Dimension Code (L/W)	Temperature of Soldering Iron Tip	Preheating Temperature	Temperature Differential (ΔT)	Atmosphere
GRM/GRJ/GXM/GJM/GQM/GJ4	03/15/18/JN/21/31/32	350°C max.	150°C min.	ΔT≤190°C	Air
GRJ/GRM/GR4/GA2/GA3	32/42/43/52/55	280°C max.	150°C min.	ΔT≤130°C	Air
GQM	22				
NFM	18/21/3D/31/41	350°C max.	150°C min.	ΔT≤190°C	Air
	15	340°C max.			

*Applicable for both Pb-Sn and Lead Free Solder.
 Pb-Sn Solder: Sn-37Pb
 Lead Free Solder: Sn-3.0Ag-0.5Cu
 *Please manage ΔT in the temperature of soldering iron and the preheating temperature.
 * Please do not rework with soldering iron for NFMJM series due to cracking concern.

2. Correction with Spot Heater

Compared to local heating with a soldering iron, hot air heating by a spot heater heats the overall component and board, therefore, it tends to lessen the thermal shock. In the case of a high density mounted board, a spot heater can also prevent concerns of the soldering iron making direct contact with the component.

- 2-1. If the distance from the hot air outlet of the spot heater to the component is too close, cracks may occur due to thermal shock. To prevent this problem, follow the conditions shown in Table 4.
- 2-2. In order to create an appropriate solder fillet shape, it is recommended that hot air be applied at the angle shown in Figure 1.

Table 4

Distance	5mm or more
Hot Air Application Angle	45° *Figure 1
Hot Air Temperature Nozzle Outlet	400°C max.
Application Time	Less than 10 seconds (Chip (L×W): 3.2×1.6mm or smaller)
	Less than 30 seconds (Chip (L×W): 3.2×2.5mm or larger)

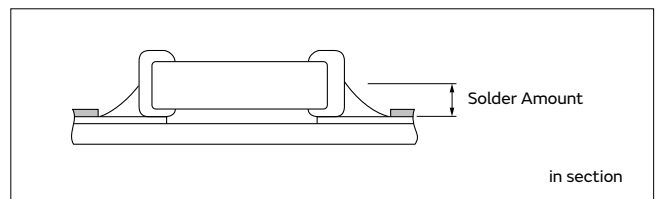
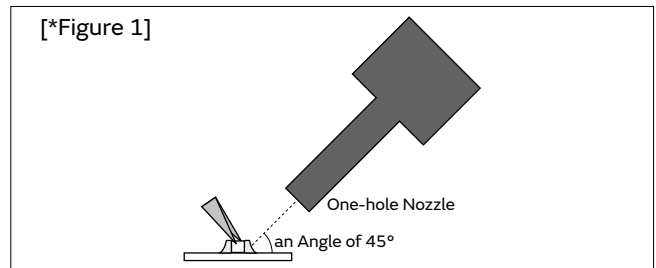

3. Optimum solder amount when re-working with a soldering iron

- 3-1. If the solder amount is excessive, the risk of cracking is higher during board bending or any other stressful condition. Too little solder amount results in a lack of adhesive strength on the termination, which may result in chips breaking loose from the PCB. Please confirm that solder has been applied smoothly and rising to the end surface of the chip.

Continued on the following page. ↗

GRM
 GR3
 GRJ
 GR4
 GJM
 GQM
 GA2
 GA3 GB
 GA3 GD
 GA3 GF
 LLL
 LLA
 LLM
 LLR
 NFM
 KRM
 KR3
 GMA
 GMD
 ⚠Caution

⚠Caution

Continued from the preceding page. ↘

- 3-2. A soldering iron with a tip of $\phi 3\text{mm}$ or smaller should be used. It is also necessary to keep the soldering iron from touching the components during the re-work.
- 3-3. Solder wire with $\phi 0.5\text{mm}$ or smaller is required for soldering.

<Applicable to KR3/KRM Series>

4. For the shape of the soldering iron tip, refer to the figure on the right.

Regarding the type of solder, use a wire diameter of $\phi 0.5\text{mm}$ or less (rosin core wire solder).

4-1. How to Apply the Soldering Iron

Apply the tip of the soldering iron against the lower end of the metal terminal.

- 1) In order to prevent cracking caused by sudden heating of the ceramic device, do not touch the ceramic base directly.
- 2) In order to prevent deviations and dislocating of the chip, do not touch the junction of the chip and the metal terminal, and the metal portion on the outside directly.

4-2. Appropriate Amount of Solder

The amount of solder for corrections by soldering iron, should be lower than the height of the lower side of the chip.

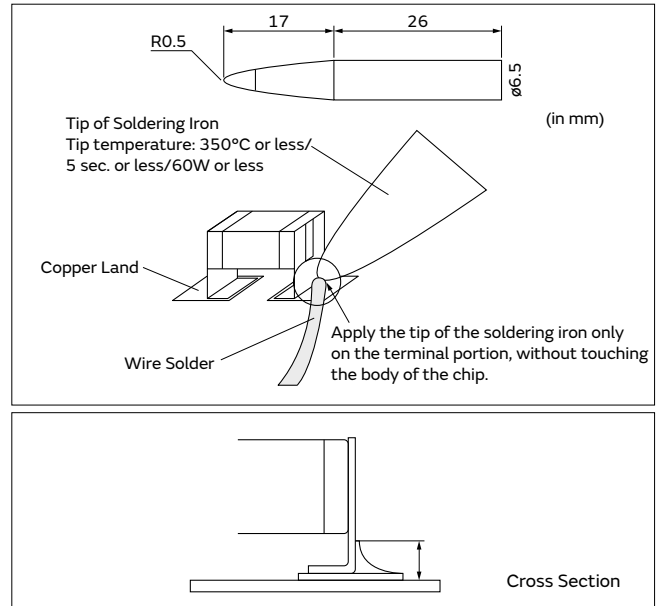

5. Washing

Excessive ultrasonic oscillation during cleaning can cause the PCBs to resonate, resulting in cracked chips or broken solder joints. Before starting your production process, test your cleaning equipment/process to insure it does not degrade the capacitors.

6. Electrical Test on Printed Circuit Board

1. Confirm position of the support pin or specific jig, when inspecting the electrical performance of a capacitor after mounting on the printed circuit board.

1-1. Avoid bending the printed circuit board by the pressure of a test-probe, etc.

The thrusting force of the test probe can flex the PCB, resulting in cracked chips or open solder joints. Provide support pins on the back side of the PCB to prevent warping or flexing. Install support pins as close to the test-probe as possible.

1-2. Avoid vibration of the board by shock when a test-probe contacts a printed circuit board.

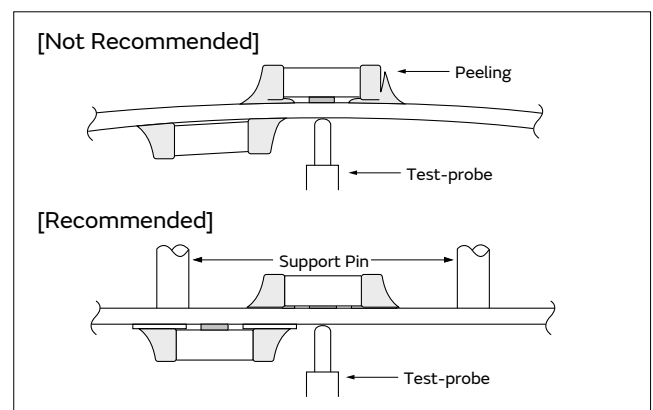

7. Printed Circuit Board Cropping

1. After mounting a capacitor on a printed circuit board, do not apply any stress to the capacitor that causes bending or twisting the board.

1-1. In cropping the board, the stress as shown at right may cause the capacitor to crack.

Cracked capacitors may cause deterioration of the insulation resistance, and result in a short.

Avoid this type of stress to a capacitor.

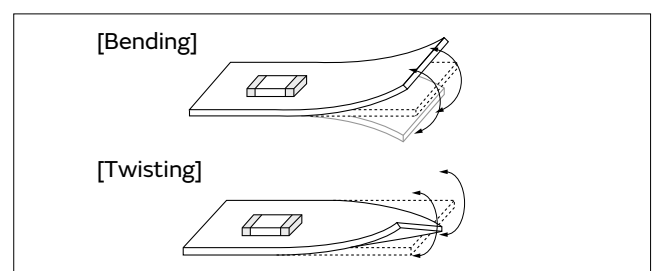

Continued on the following page. ↗

GRM
 GR3
 GRJ
 GR4
 GJM
 GQM
 GA2
 GA3 GB
 GA3 GD
 GA3 GF
 LLL
 LLA
 LLM
 LLR
 NFM
 KRM
 KR3
 GMA
 GMD
 ⚠Caution

⚠Caution

Continued from the preceding page. ↘

2. Check the cropping method for the printed circuit board in advance.

2-1. Printed circuit board cropping shall be carried out by using a jig or an apparatus (Disc separator, router type separator, etc.) to prevent the mechanical stress that can occur to the board.

Board Separation Method	Hand Separation Nipper Separation	(1) Board Separation Jig	Board Separation Apparatus	
			(2) Disc Separator	(3) Router Type Separator
Level of stress on board	High	Medium	Medium	Low
Recommended	×	△*	△*	○
Notes	Hand and nipper separation apply a high level of stress. Use another method.	<ul style="list-style-type: none"> Board handling Board bending direction Layout of capacitors 	<ul style="list-style-type: none"> Board handling Layout of slits Design of V groove Arrangement of blades Controlling blade life 	Board handling

* When a board separation jig or disc separator is used, if the following precautions are not observed, a large board deflection stress will occur and the capacitors may crack. Use router type separator if at all possible.

(1) Example of a suitable jig

[In the case of Single-side Mounting]

An outline of the board separation jig is shown as follows. Recommended example: Stress on the component mounting position can be minimized by holding the portion close to the jig, and bend in the direction towards the side where the capacitors are mounted. Not recommended example: The risk of cracks occurring in the capacitors increases due to large stress being applied to the component mounting position, if the portion away from the jig is held and bent in the direction opposite the side where the capacitors are mounted.

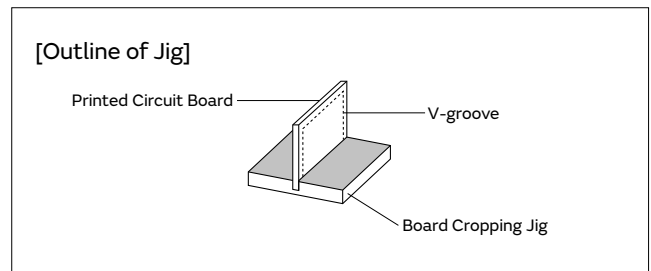

Hand Separation

Recommended	Not Recommended

[In the case of Double-sided Mounting]

Since components are mounted on both sides of the board, the risk of cracks occurring can not be avoided with the above method. Therefore, implement the following measures to prevent stress from being applied to the components.

(Measures)

- (1) Consider introducing a router type separator. If it is difficult to introduce a router type separator, implement the following measures. (Refer to item 1. Mounting Position)
- (2) Mount the components parallel to the board separation surface.
- (3) When mounting components near the board separation point, add slits in the separation position near the component.
- (4) Keep the mounting position of the components away from the board separation point.

Continued on the following page. ↗

Caution

Continued from the preceding page. ↘

(2) Example of a Disc Separator

An outline of a disc separator is shown as follows. As shown in the Principle of Operation, the top blade and bottom blade are aligned with the V-grooves on the printed circuit board to separate the board.

In the following case, board deflection stress will be applied and cause cracks in the capacitors.

- (1) When the adjustment of the top and bottom blades are misaligned, such as deviating in the top-bottom, left-right or front-rear directions
- (2) The angle of the V groove is too low, depth of the V groove is too shallow, or the V groove is misaligned top-bottom

IF V groove is too deep, it is possible to brake when you handle and carry it. Carefully design depth of the V groove with consideration about strength of material of the printed circuit board.

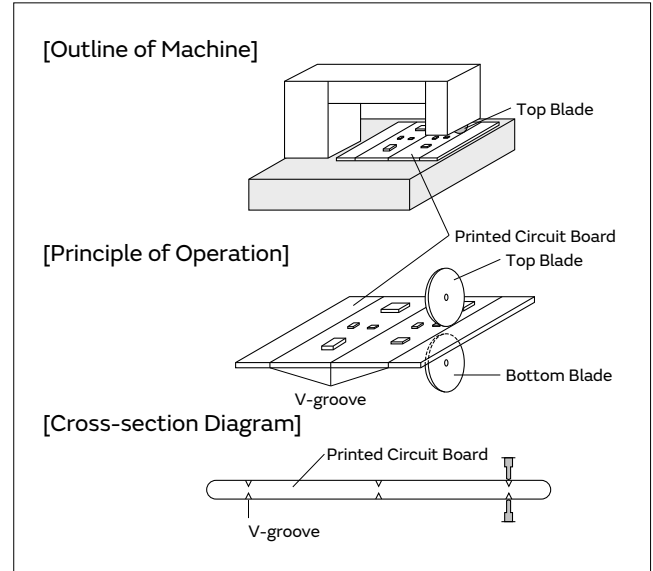

Disc Separator

Recommended	Not Recommended		
	Top-bottom Misalignment	Left-right Misalignment	Front-rear Misalignment
<p>Top Blade</p> <p>Bottom Blade</p>	<p>Top Blade</p> <p>Bottom Blade</p>	<p>Top Blade</p> <p>Bottom Blade</p>	<p>Top Blade</p> <p>Bottom Blade</p>

V-groove Design

Example of Recommended V-groove Design	Not Recommended			
	Left-right Misalignment	Low-Angle	Depth too Shallow	Depth too Deep

(3) Example of Router Type Separator

The router type separator performs cutting by a router rotating at a high speed. Since the board does not bend in the cutting process, stress on the board can be suppressed during board separation.

When attaching or removing boards to/from the router type separator, carefully handle the boards to prevent bending.

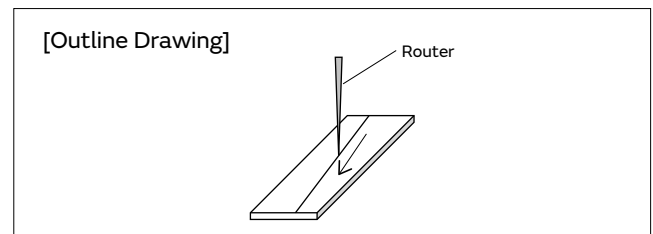

Continued on the following page. ↗

⚠Caution

Continued from the preceding page. ↘

8. Assembly

1. Handling

If a board mounted with capacitors is held with one hand, the board may bend. Firmly hold the edges of the board with both hands when handling.

If a board mounted with capacitors is dropped, cracks may occur in the capacitors.

Do not use dropped boards, as there is a possibility that the quality of the capacitors may be impaired.

2. Attachment of Other Components

2-1. Mounting of Other Components

Pay attention to the following items, when mounting other components on the back side of the board after capacitors have been mounted on the opposite side.

When the bottom dead point of the suction nozzle is set too low, board deflection stress may be applied to the capacitors on the back side (bottom side), and cracks may occur in the capacitors.

- After the board is straightened, set the bottom dead point of the nozzle on the upper surface of the board.
- Periodically check and adjust the bottom dead point.

2-2. Inserting Components with Leads into Boards

When inserting components (transformers, IC, etc.) into boards, bending the board may cause cracks in the capacitors or cracks in the solder.

Pay attention to the following.

- Increase the size of the holes to insert the leads, to reduce the stress on the board during insertion.
- Fix the board with support pins or a dedicated jig before insertion.
- Support below the board so that the board does not bend. When using support pins on the board, periodically confirm that there is no difference in the height of each support pin.

2-3. Attaching/Removing Sockets and/or Connectors

Insertion and removal of sockets and connectors, etc., might cause the board to bend. Please insure that the board does not warp during insertion and removal of sockets and connectors, etc., or the bending may damage mounted components on the board.

2-4. Tightening Screws

The board may be bent, when tightening screws, etc. during the attachment of the board to a shield or chassis.

Pay attention to the following items before performing the work.

- Plan the work to prevent the board from bending.
- Use a torque screwdriver, to prevent over-tightening of the screws.
- The board may bend after mounting by reflow soldering, etc. Please note, as stress may be applied to the chips by forcibly flattening the board when tightening the screws.

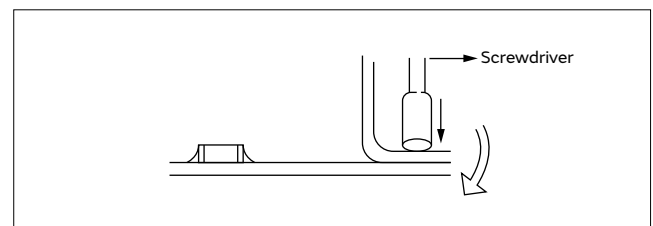
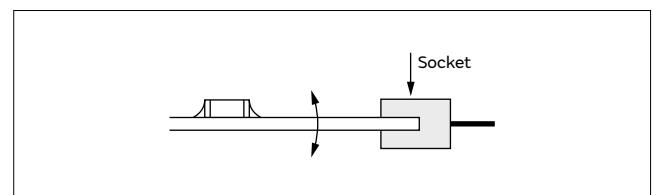
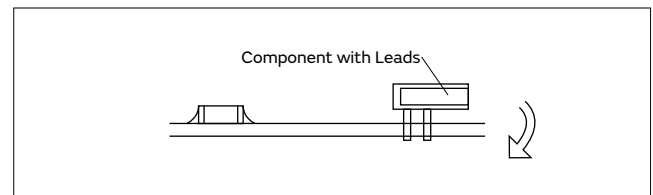
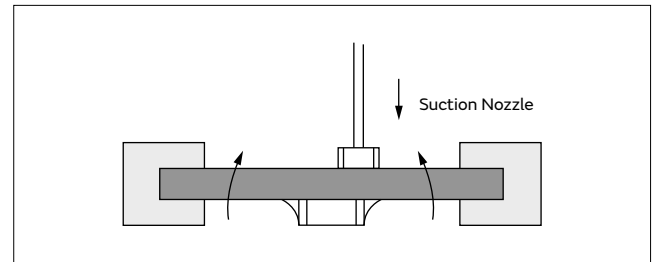

GRM

GR3

GRJ

GR4

GJM

GQM

GA2

GA3
GB

GA3
GD

GA3
GF

LLL

LLA

LLM

LLR

NFM

KRM

KR3

GMA

GMD

⚠Caution

Continued on the following page. ↗

⚠Caution

Continued from the preceding page. ↘

<Applicable to GMA or GMD Series>

9. Die Bonding/Wire Bonding

1. Die Bonding of Capacitors

1-1. Use the following materials for the Brazing alloys:

Au-Sn (80/20) 300 to 320 °C in N₂ atmosphere

1-2. Mounting

- (1) Control the temperature of the substrate so it matches the temperature of the brazing alloy.
- (2) Place the brazing alloy on the substrate and place the capacitor on the alloy. Hold the capacitor and gently apply the load. Be sure to complete the operation within 1 minute.

2. Wire Bonding

2-1. Wire

Gold wire: 25 micro m (0.001 inch) diameter

2-2. Bonding

- (1) Thermo compression, ultrasonic ball bonding.
- (2) Required stage temperature: 150 to 200 °C
- (3) Required wedge or capillary weight: 0.2N to 0.5N
- (4) Bond the capacitor and base substrate or other devices with gold wire.

Other

1. Under Operation of Equipment

- 1-1. Do not touch a capacitor directly with bare hands during operation in order to avoid the danger of an electric shock.
- 1-2. Do not allow the terminals of a capacitor to come in contact with any conductive objects (short-circuit). Do not expose a capacitor to a conductive liquid, including any acid or alkali solutions.
- 1-3. Confirm the environment in which the equipment will operate is under the specified conditions. Do not use the equipment under the following environments.
 - (1) Being splattered with water or oil.
 - (2) Being exposed to direct sunlight.
 - (3) Being exposed to ozone, ultraviolet rays, or radiation.
 - (4) Being exposed to toxic gas (e.g., hydrogen sulfide, sulfur dioxide, chlorine, ammonia gas, etc.)
 - (5) Any vibrations or mechanical shocks exceeding the specified limits.
 - (6) Moisture condensing environments. (GXM Series: Terrible moisture condensing environments).
- 1-4. Use damp proof countermeasures if using under any conditions that can cause condensation. (GXM Series: Use damp proof countermeasures if using under any conditions that can cause terrible condensation).

Continued on the following page. ↗

GRM

GR3

GRJ

GR4

GJM

GQM

GA2

GA3
GB

GA3
GD

GA3
GF

LLL

LLA

LLM

LLR

NFM

KRM

KR3

GMA

GMD

⚠Caution

⚠Caution

Continued from the preceding page. ↘

2. Other

2-1. In an Emergency

- (1) If the equipment should generate smoke, fire, or smell, immediately turn off or unplug the equipment.

If the equipment is not turned off or unplugged, the hazards may be worsened by supplying continuous power.

- (2) In this type of situation, do not allow face and hands to come in contact with the capacitor or burns may be caused by the capacitor's high temperature.

2-2. Disposal of Waste

When capacitors are disposed of, they must be burned or buried by an industrial waste vendor with the appropriate licenses.

2-3. Circuit Design

(1) Addition of Fail Safe Function

Capacitors that are cracked by dropping or bending of the board may cause deterioration of the insulation resistance, and result in a short.

If the circuit being used may cause an electrical shock, smoke or fire when a capacitor is shorted, be sure to install fail-safe functions, such as a fuse, to prevent secondary accidents.

- (2) Capacitors used to prevent electromagnetic interference in the primary AC side circuit, or as a connection/insulation, must be a safety standard certified product, or satisfy the contents stipulated in the Electrical Appliance and Material Safety Law. Install a fuse for each line in case of a short.

- (3) The GRM, GR3, GRJ, GXM, GJM, GQM, LLL, LLA, LLM, LLR, NFM, GJ4, ZRA, ZRB, KRM, KR3, GMA and GMD series are not safety standard certified products.

2-4. Test Condition for AC Withstanding Voltage

(1) Test Equipment

Test equipment for AC withstanding voltage should be made with equipment capable of creating a wave similar to a 50/60Hz sine wave.

(2) Voltage Applied Method

The capacitor's lead or terminal should be firmly connected to the output of the withstanding voltage test equipment, and then the voltage should be raised from near zero to the test voltage.

If the test voltage is applied directly to the capacitor without raising it from near zero, it should be applied with the zero cross. *At the end of the test time, the test voltage should be reduced to near zero, and then capacitor's lead or terminals should be taken off the output of the withstanding voltage test equipment.

If the test voltage applied directly to the capacitor without raising it from near zero, surge voltage may occur and cause a defect.

*ZERO CROSS is the point where voltage sine wave passes 0V. - See the figure at right -

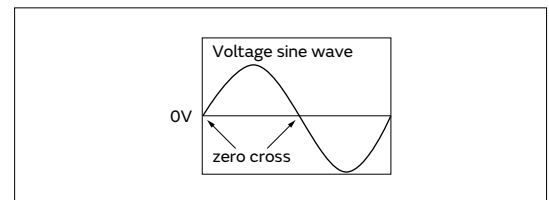

2-5. Remarks

Failure to follow the cautions may result, worst case, in a short circuit and smoking when the product is used.

The above notices are for standard applications and conditions. Contact us when the products are used in special mounting conditions.

Select optimum conditions for operation as they determine the reliability of the product after assembly.

The data herein are given in typical values, not guaranteed ratings.

GRM

GR3

GRJ

GR4

GJM

GQM

GA2

GA3

GB

GA3

GD

GA3

GF

LLL

LLA

LLM

LLR

NFM

KRM

KR3

GMA

GMD

⚠Caution

Notice

Rating

1. Operating Temperature

1. The operating temperature limit depends on the capacitor.

1-1. Do not apply temperatures exceeding the maximum operating temperature.

It is necessary to select a capacitor with a suitable rated temperature that will cover the operating temperature range.

It is also necessary to consider the temperature distribution in equipment and the seasonal temperature variable factor.

1-2. Consider the self-heating factor of the capacitor.

The surface temperature of the capacitor shall not exceed the maximum operating temperature including self-heating.

2. Atmosphere Surroundings (gaseous and liquid)

1. Restriction on the operating environment of capacitors.

1-1. Capacitors, when used in the above, unsuitable, operating environments may deteriorate due to the corrosion of the terminations and the penetration of moisture into the capacitor.

1-2. The same phenomenon as the above may occur when the electrodes or terminals of the capacitor are subject to moisture condensation.

1-3. The deterioration of characteristics and insulation resistance due to the oxidization or corrosion of terminal electrodes may result in breakdown when the capacitor is exposed to corrosive or volatile gases or solvents for long periods of time.

3. Piezo-electric Phenomenon

1. When using high dielectric constant type capacitors in AC or pulse circuits, the capacitor itself vibrates at specific frequencies and noise may be generated.

Moreover, when the mechanical vibration or shock is added to the capacitor, noise may occur.

Soldering and Mounting

1. PCB Design

1. Notice for Pattern Forms

1-1. Unlike leaded components, chip components are susceptible to flexing stresses since they are mounted directly on the substrate.

They are also more sensitive to mechanical and thermal stresses than leaded components.

Excess solder fillet height can multiply these stresses and cause chip cracking. When designing substrates, take land patterns and dimensions into consideration to eliminate the possibility of excess solder fillet height.

1-2. There is a possibility of chip cracking caused by PCB expansion/contraction with heat, because stress on a chip is different depending on PCB material and structure. When the thermal expansion coefficient greatly differs between the board used for mounting and the chip, it will cause cracking of the chip due to the thermal expansion and contraction.

When capacitors are mounted on a fluorine resin printed circuit board or on a single-layered glass epoxy board, it may also cause cracking of the chip for the same reason.

1-3. If you are replacing by smaller capacitors, you should not only consider the Land size change but also consider changing the Wiring Width, Wiring direction, and copper foil thickness because the risk of chip cracking is increased with just a Land size change.

<Applicable to NFM Series>



1-4. Because noise is suppressed by shunting unwanted high-frequency components to the ground, when designing a land for the NFM series, design the ground pattern to be as large as possible in order to better bring out this characteristic. As shown in the figure below, noise countermeasures can be made more effective by using a via to connect the ground pattern on the chip mounting surface to a larger ground pattern on the inner layer.

Continued on the following page. ↗

Notice

Continued from the preceding page. ↘

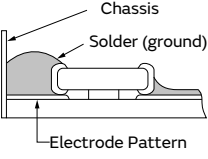
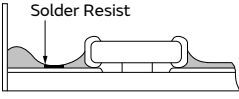
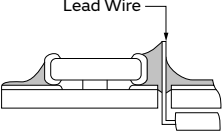
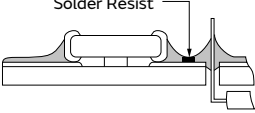
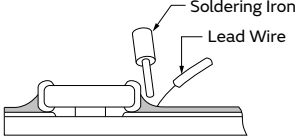
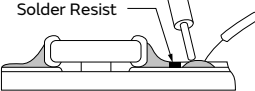
Pattern Forms

	Prohibited	Correct
Placing Close to Chassis	 <p>Chassis Solder (ground) Electrode Pattern</p> <p>in section</p>	 <p>Solder Resist</p> <p>in section</p>
Placing of Chip Components and Leaded Components	 <p>Lead Wire</p> <p>in section</p>	 <p>Solder Resist</p> <p>in section</p>
Placing of Leaded Components after Chip Component	 <p>Soldering Iron Lead Wire</p> <p>in section</p>	 <p>Solder Resist</p> <p>in section</p>
Lateral Mounting		 <p>Solder Resist</p>

2. Land Dimensions

2-1. Please refer to the land dimensions in table 1 for flow soldering, table 2 for reflow soldering, table 3 for reflow soldering for ZRB Series, table 4 for reflow soldering for LLA Series, table 5 for reflow soldering for LLM Series, table 6 and 7 for reflow soldering for ZRA Series.

Please confirm the suitable land dimension by evaluating of the actual SET / PCB.

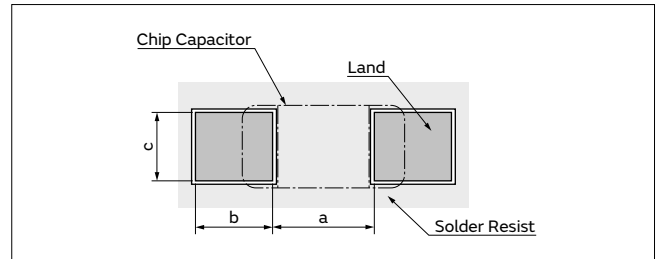

Table 1 Flow Soldering Method

Series	Chip Dimension Code (L/W)	Chip (L×W)	a	b	c
GQM/GR3/GRJ/GRM	18	1.6×0.8	0.6 to 1.0	0.8 to 0.9	0.6 to 0.8
GQM/GR3/GRJ/GRM	21	2.0×1.25	1.0 to 1.2	0.9 to 1.0	0.8 to 1.1
GR3/GRJ/GRM	31	3.2×1.6	2.2 to 2.6	1.0 to 1.1	1.0 to 1.4
LLL	21	1.25×2.0	0.4 to 0.7	0.5 to 0.7	1.4 to 1.8
LLL	31	1.6×3.2	0.6 to 1.0	0.8 to 0.9	2.6 to 2.8

(in mm)

Continued on the following page. ↗

Notice

Continued from the preceding page. ↘

Table 2 Reflow Soldering Method

Series	Chip Dimension Code (L/W)	Chip (L×W)	a	b	c
GRM	01	0.25×0.125	0.10 to 0.11	0.07 to 0.12	0.125 to 0.145
GRM/GJM	02	0.4×0.2	0.16 to 0.2	0.12 to 0.18	0.2 to 0.23
GRM	MD	0.5×0.25	0.17 to 0.23	0.22 to 0.28	0.25 to 0.30
GRM/GJM	03	0.6×0.3 (±0.03)	0.2 to 0.25	0.2 to 0.3	0.25 to 0.35
		0.6×0.3 (±0.05)	0.2 to 0.25	0.25 to 0.35	0.3 to 0.4
		0.6×0.3 (±0.09)	0.23 to 0.3	0.25 to 0.35	0.3 to 0.4
GRM/GXM/GJM	15	1.0×0.5 (within ±0.10)	0.3 to 0.5	0.35 to 0.45	0.4 to 0.6
		1.0×0.5 (±0.15/±0.20)	0.4 to 0.6	0.4 to 0.5	0.5 to 0.7
GRM/GXM/GJM/GQM	18	1.6×0.8 (within ±0.10)	0.6 to 0.8	0.6 to 0.7	0.6 to 0.8
		1.6×0.8 (±0.15/±0.20)	0.7 to 0.9	0.7 to 0.8	0.8 to 1.0
GRM	JN	1.8×1.0	0.8 to 0.9	0.6 to 0.8	0.9 to 1.1
GQM	21	2.0×1.25	1.0 to 1.2	0.6 to 0.7	0.8 to 1.1
GRM/GXM/GRJ/GJ4	21	2.0×1.25 (within ±0.10)	1.2	0.6	1.25
		2.0×1.25 (±0.15)	1.2	0.6 to 0.8	1.2 to 1.4
		2.0×1.25 (±0.20)	1.0 to 1.4	0.6 to 0.8	1.2 to 1.4
GQM	22	2.8×2.8	2.2 to 2.5	0.8 to 1.0	1.9 to 2.3
GRM/GXM/GRJ/GJ4	31	3.2×1.6 (within ±0.20)	1.8 to 2.0	0.9 to 1.2	1.5 to 1.7
		3.2×1.6 (±0.30)	1.9 to 2.1	1.0 to 1.3	1.7 to 1.9
GRM/GXM/GRJ	32	3.2×2.5	2.0 to 2.4	1.0 to 1.2	1.8 to 2.3
GA2/GA3/GR4	42	4.5×2.0	2.8 to 3.4	1.2 to 1.4	1.4 to 1.8
GR3/GRJ/GRM/GA2/GA3/GR4	43	4.5×3.2	3.0 to 3.5	1.2 to 1.4	2.3 to 3.0
GA2/GA3	52	5.7×2.8	4.0 to 4.6	1.4 to 1.6	2.1 to 2.6
GR3/GRJ/GRM/GA2/GA3/GR4	55	5.7×5.0	4.0 to 4.6	1.4 to 1.6	3.5 to 4.8
LLL	15	0.5×1.0	0.15 to 0.2	0.2 to 0.25	0.7 to 1.0
LLL	1U	0.6×1.0	0.20 to 0.25	0.25 to 0.35	0.7 to 1.0
LLL/LLR	18	0.8×1.6	0.2 to 0.3	0.3 to 0.4	1.4 to 1.6
LLL	21	1.25×2.0	0.4 to 0.5	0.4 to 0.5	1.4 to 1.8
LLL	31	1.6×3.2	0.6 to 0.8	0.6 to 0.7	2.6 to 2.8

(in mm)

<Applicable to Part Number KR3/KRM>

Series	Chip Dimension Code (L/W)	Chip (L×W)	a	b	c
KRM	21	2.0×1.25	1.0 to 1.2	0.6 to 0.7	0.8 to 1.1
KRM	31	3.2×1.6	2.2 to 2.4	0.8 to 0.9	1.0 to 1.4
KR3/KRM	55	5.7×5.0	2.6	2.7	5.6

(in mm)

Table 3 ZRB Series Reflow Soldering Method

Series	Chip Dimension Code (L/W)	Chip (L×W)	a	b	c
ZRB	15	1.0×0.5	0.4 to 0.6	0.4 to 0.5	0.5 to 0.7
ZRB	18*	1.6×0.8	0.7 to 0.9	0.7 to 0.8	0.8 to 1.0

*If distance between parts is too short, there is risk to cause electrical short. Please confirm the mounting pitch (distance between centers of parts) has 1.275mm or more. (ZRB18 only)

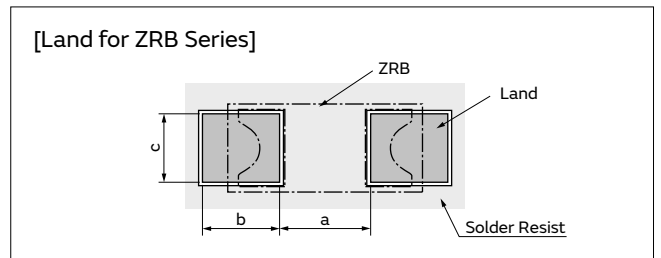

Table 4 LLA Series Reflow Soldering Method

Series	Chip Dimension Code (L/W)	Chip (L×W)	a	b	c	p
LLA	18	1.6×0.8	0.3 to 0.4	0.25 to 0.35	0.15 to 0.25	0.4
LLA	21	2.0×1.25	0.5 to 0.7	0.35 to 0.6	0.2 to 0.3	0.5

(in mm)

Continued on the following page. ↗

Notice

Continued from the preceding page. ↘

Table 5 LLM Series Reflow Soldering Method

Series	Chip Dimension Code (L/W)	Chip (L×W)	a	b, b'	c, c'	d	e	f	p
LLM	21	2.0×1.25	0.6 to 0.8	(0.3 to 0.5)	0.3	2.0 to 2.6	1.3 to 1.8	1.4 to 1.6	0.5

$b=(c-e)/2, b'=(d-f)/2$ (in mm)

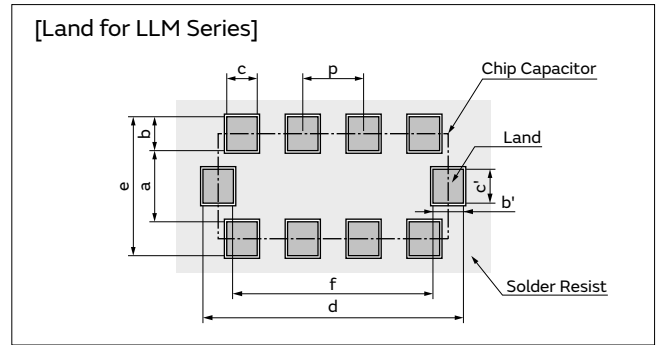
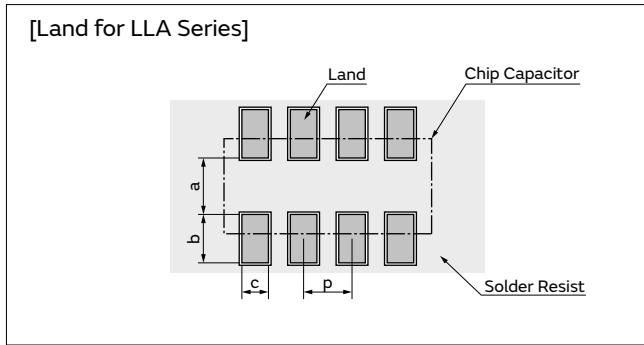

<Applicable to beyond Rated Voltage of 200VDC>

2-2. Dimensions of Slit (Example)

Preparing the slit helps flux cleaning and resin coating on the back of the capacitor.

However, the length of the slit design should be as short as possible to prevent mechanical damage in the capacitor.

A longer slit design might receive more severe mechanical stress from the PCB.

Recommended slit design is shown in the Table.

L×W	d	e
1.6×0.8	-	-
2.0×1.25	-	-
3.2×1.6	1.0 to 2.0	3.2 to 3.7
3.2×2.5	1.0 to 2.0	4.1 to 4.6
4.5×2.0	1.0 to 2.8	3.6 to 4.1
4.5×3.2	1.0 to 2.8	4.8 to 5.3
5.7×2.8	1.0 to 4.0	4.4 to 4.9
5.7×5.0	1.0 to 4.0	6.6 to 7.1

(in mm)

<Applicable to ZRA Series>

Please refer to the land dimensions in Table 6 and the solder amount in Table 7 for ZRA series.

(1) Recommended Land Dimensions

Table 6 Land Dimensions

Series	Chip Dimension Code (L/W)	Chip (L×W)	a	b	c
ZRA	21	2.4×1.65	0.8±0.05	1.0±0.05	1.4±0.05

(in mm)

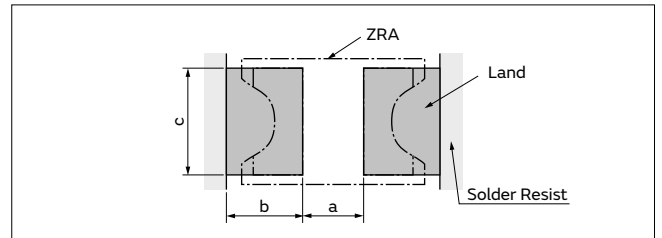

(2) Recommended Solder Amount

Table 7 Solder Amount

Series	Chip Dimension Code (L/W)	Thickness	a'	b'	c'
ZRA	21	0.1	0.8±0.05	1.0±0.05	0.7±0.05

(in mm)

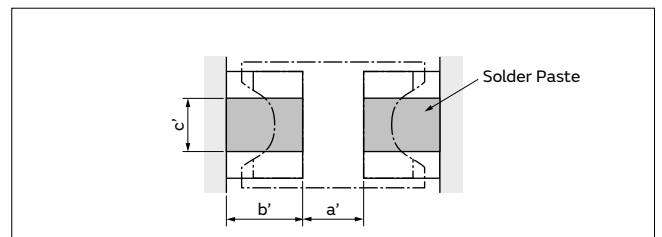

Continued on the following page. ↗

Notice

Continued from the preceding page. ↘

<Applicable to NFM Series>

Land Pattern + Solder Resist Land Pattern Solder Resist (in mm)

Series	Land Dimensions		
NFM15CC NFM15PC NFMJMPC NFM18CC NFM18PS NFM21CC NFM21PC NFM21PS	● Reflow Soldering NFM15CC/NFM15PC 	NFMJMPC 	NFM18CC/NFM18PC
	NFM18PS 	NFM21CC/NFM21PC 	NFM21PS
	<p>In case of changing the land dimensions marked by *, a solder bridge between terminations of the chip could occur. In this case, please contact us before change.</p>		

Series	● Reflow Soldering Chip mounting side		● Flow Soldering Chip mounting side																																							
	NFM3DCC NFM3DPC NFM31PC NFM31KC NFM41CC NFM41PC	NFM3DCC/NFM3DPC/NFM31PC/NFM41CC/NFM41PC Small diameter thru hole ø0.4 <table border="1"> <thead> <tr> <th rowspan="2">Part Number</th> <th colspan="7">Size (mm)</th> </tr> <tr> <th>a</th> <th>b</th> <th>c</th> <th>d</th> <th>e</th> <th>f</th> <th>g</th> </tr> </thead> <tbody> <tr> <td>NFM3DCC NFM3DPC</td> <td>1.0</td> <td>1.4</td> <td>2.5</td> <td>4.4</td> <td>1.0</td> <td>2.0</td> <td>2.4</td> </tr> <tr> <td>NFM31PC</td> <td>1.0</td> <td>1.4</td> <td>2.5</td> <td>4.4</td> <td>1.2</td> <td>2.6</td> <td>3.0</td> </tr> <tr> <td>NFM41CC NFM41PC</td> <td>1.5</td> <td>2.0</td> <td>3.5</td> <td>6.0</td> <td>1.2</td> <td>2.6</td> <td>3.0</td> </tr> </tbody> </table>	Part Number	Size (mm)							a	b	c	d	e	f	g	NFM3DCC NFM3DPC	1.0	1.4	2.5	4.4	1.0	2.0	2.4	NFM31PC	1.0	1.4	2.5	4.4	1.2	2.6	3.0	NFM41CC NFM41PC	1.5	2.0	3.5	6.0	1.2	2.6	3.0	NFM31KC*1 Small diameter thru hole ø0.4 <p>*1 For large current design, width of signal land pattern should be wider not less than 1mm per 1A (1mm/A). For example, in case of 10A, signal land pattern width should be 10mm or more. (1mm/A*10A=10mm)</p>
Part Number	Size (mm)																																									
	a	b	c	d	e	f	g																																			
NFM3DCC NFM3DPC	1.0	1.4	2.5	4.4	1.0	2.0	2.4																																			
NFM31PC	1.0	1.4	2.5	4.4	1.2	2.6	3.0																																			
NFM41CC NFM41PC	1.5	2.0	3.5	6.0	1.2	2.6	3.0																																			

Continued on the following page. ↗

GRM
GR3
GRJ
GR4
GJM
GQM
GA2
GA3 GB
GA3 GD
GA3 GF
LLL
LLA
LLM
LLR
NFM
KRM
KR3
GMA
GMD
Notice

Notice

Continued from the preceding page. ↘

3. Board Design

When designing the board, keep in mind that the amount of strain which occurs will increase depending on the size and material of the board.

[Relationship with amount of strain to the board thickness, length, width, etc.]

$$\epsilon = \frac{3PL}{2Ewh^2} \quad \text{Relationship between load and strain}$$

ϵ : Strain on center of board (μst)
 L : Distance between supporting points (mm)
 w : Board width (mm)
 h : Board thickness (mm)
 E : Elastic modulus of board ($\text{N}/\text{m}^2=\text{Pa}$)
 Y : Deflection (mm)
 P : Load (N)

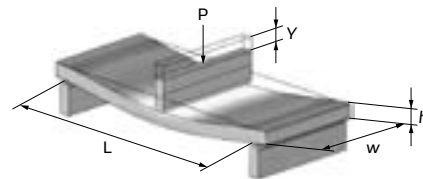

When the load is constant, the following relationship can be established.

- As the distance between the supporting points (L) increases, the amount of strain also increases.
→Reduce the distance between the supporting points.
 - As the elastic modulus (E) decreases, the amount of strain increases.
→Increase the elastic modulus.
 - As the board width (w) decreases, the amount of strain increases.
→Increase the width of the board.
 - As the board thickness (h) decreases, the amount of strain increases.
→Increase the thickness of the board.
- Since the board thickness is squared, the effect on the amount of strain becomes even greater.

2. Item to be confirmed for Flow soldering

If you want to temporarily attach the capacitor to the board using an adhesive agent before soldering the capacitor, first be sure that the conditions are appropriate for affixing the capacitor. If the dimensions of the land, the type of adhesive, the amount of coating, the contact surface area, the curing temperature, or other conditions are inappropriate, the characteristics of the capacitor may deteriorate.

1. Selection of Adhesive

1-1. Depending on the type of adhesive, there may be a decrease in insulation resistance. In addition, there is a chance that the capacitor might crack from contractile stress due to the difference in the contraction rate of the capacitor and the adhesive.

1-2. If there is not enough adhesive, the contact surface area is too small, or the curing temperature or curing time are inadequate, the adhesive strength will be insufficient and the capacitor may loosen or become disconnected during transportation or soldering. If there is too much adhesive, for example if it overflows onto the land, the result could be soldering defects, loss of electrical connection, insufficient curing, or slippage after the capacitor is mounted.

Furthermore, if the curing temperature is too high or the curing time is too long, not only will the adhesive

strength be reduced, but solderability may also suffer due to the effects of oxidation on the terminations (outer electrodes) of the capacitor and the land surface on the board.

(1) Selection of Adhesive

Epoxy resins are a typical class of adhesive.

To select the proper adhesive, consider the following points.

- 1) There must be enough adhesive strength to prevent the component from loosening or slipping during the mounting process.
- 2) The adhesive strength must not decrease when exposed to moisture during soldering.
- 3) The adhesive must have good coatability and shape retention properties.
- 4) The adhesive must have a long pot life.
- 5) The curing time must be short.
- 6) The adhesive must not be corrosive to the exterior of the capacitor or the board.
- 7) The adhesive must have good insulation properties.
- 8) The adhesive must not emit toxic gases or otherwise be harmful to health.
- 9) The adhesive must be free of halogenated compounds.

Continued on the following page. ↗

Notice

Continued from the preceding page. ↘

(2) Use the following illustration as a guide to the amount of adhesive to apply.

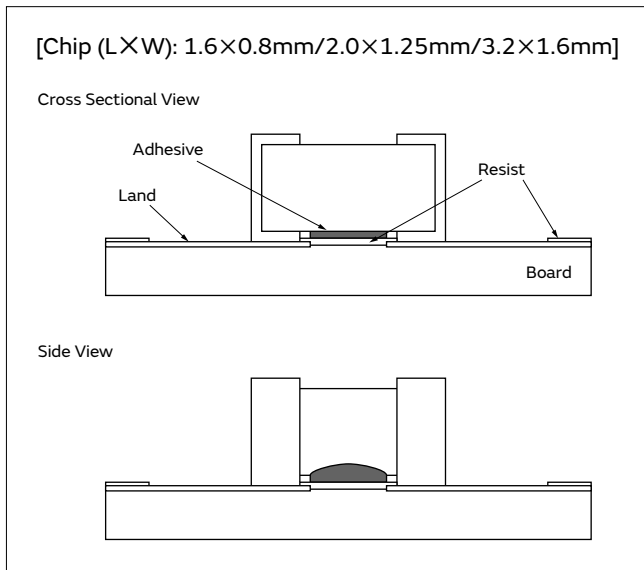

<Applicable to NFM Series>

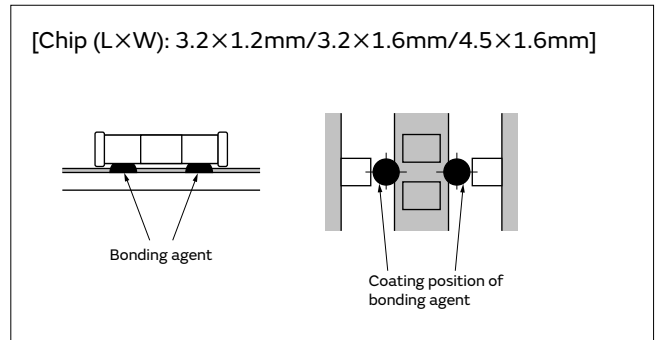

2. Flux

- 2-1. An excessive amount of flux generates a large quantity of flux gas, which can cause a deterioration of solderability, so apply flux thinly and evenly throughout. (A foaming system is generally used for flow soldering.)
- 2-2. Flux containing too high a percentage of halide may cause corrosion of the terminations unless there is sufficient cleaning. Use flux with a halide content of 0.1% max.
- 2-3. Strong acidic flux can corrode the capacitor and degrade its performance.
Please check the quality of capacitor after mounting.

3. Leaching of the terminations

- Set temperature and time to ensure that leaching of the terminations does not exceed 25% of the chip end area as a single chip (full length of the edge A-B-C-D shown at right) and 25% of the length A-B shown as mounted on substrate.

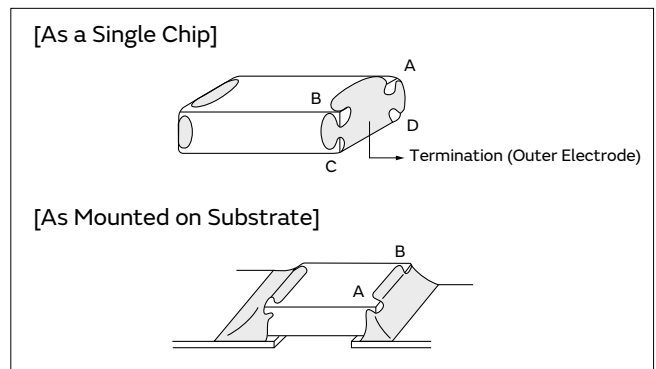

3. Reflow Soldering

The flux in the solder paste contains halogen-based substances and organic acids as activators. Strong acidic flux can corrode the capacitor and degrade its performance. Please check the quality after mounting, please use.

Continued on the following page. ↗

Notice

Continued from the preceding page. ↘

4. Washing

1. Please evaluate the capacitor using actual cleaning equipment and conditions to confirm the quality, and select the solvent for cleaning.

5. Coating

1. A crack may be caused in the capacitor due to the stress of the thermal contraction of the resin during curing process.
The stress is affected by the amount of resin and curing contraction.
Select a resin with low curing contraction.
The difference in the thermal expansion coefficient between a coating resin or a molding resin and the capacitor may cause the destruction and deterioration of the capacitor such as a crack or peeling, and lead to the deterioration of insulation resistance or dielectric breakdown.
Select a resin for which the thermal expansion coefficient is as close to that of the capacitor as possible.
A silicone resin can be used as an under-coating to buffer against the stress.

2. Unsuitable cleaning may leave residual flux or other foreign substances, causing deterioration of electrical characteristics and the reliability and water repellency* of the capacitors.
*GXM only

2. Select a resin that is less hygroscopic.
Using hygroscopic resins under high humidity conditions may cause the deterioration of the insulation resistance of a capacitor.
An epoxy resin can be used as a less hygroscopic resin.
3. The halogen system substance and organic acid are included in coating material, and a chip corrodes by the kind of Coating material.
Do not use strong acid type.

<Applicable to ZRA/ZRB Series>

4. Loss suppress acoustic noise may be caused in ZRA/ZRB series due to the resin during curing process. Please contact our sales representative or product engineers on the apply to resin during curing process.

Other

1. Transportation

1. The performance of a capacitor may be affected by the conditions during transportation.
 - 1-1. The capacitors shall be protected against excessive temperature, humidity, and mechanical force during transportation.
 - (1) Climatic condition
 - low air temperature: -40°C
 - change of temperature air/air: -25°C/+25°C
 - low air pressure: 30 kPa
 - change of air pressure: 6 kPa/min.
 - (2) Mechanical condition
Transportation shall be done in such a way that the boxes are not deformed and forces are not directly passed on to the inner packaging.
 - 1-2. Do not apply excessive vibration, shock, or pressure to the capacitor.
 - (1) When excessive mechanical shock or pressure is applied to a capacitor, chipping or cracking may occur in the ceramic body of the capacitor.
 - (2) When the sharp edge of an air driver, a soldering iron, tweezers, a chassis, etc. impacts strongly on the surface of the capacitor, the capacitor may crack and short-circuit.
 - 1-3. Do not use a capacitor to which excessive shock was applied by dropping, etc.
A capacitor dropped accidentally during processing may be damaged.

2. Characteristics Evaluation in the Actual System

1. Evaluate the capacitor in the actual system, to confirm that there is no problem with the performance and specification values in a finished product before using.
2. Since a voltage dependency and temperature dependency exists in the capacitance of high dielectric type ceramic capacitors, the capacitance may change depending on the operating conditions in the actual system. Therefore, be sure to evaluate the various characteristics, such as the leakage current and noise absorptivity, which will affect the capacitance value of the capacitor.
3. In addition, voltages exceeding the predetermined surge may be applied to the capacitor by the inductance in the actual system. Evaluate the surge resistance in the actual system as required.

<Applicable to NFM Series>

4. The effects of noise suppression can vary depending on the usage conditions, including differences in the circuit or IC to be used, the type of noise, the shape of the pattern to be mounted, and the mounting location. Be sure to verify the effect on the actual device in advance.

GRM

GR3

GRJ

GR4

GJM

GQM

GA2

GA3

GB

GA3

GD

GA3

GF

LLL

LLA

LLM

LLR

NFM

KRM

KR3

GMA

GMD

Notice

Design Support Tool "SimSurfing"

<https://www.murata.com/simsurfing/>

This is the latest tool to get the electrical characteristics for Capacitors, Inductors, and EMI Suppression Filters, and to simulate Thermistors' behavior !



■ Characteristics viewer
 You can easily search and download the following data for Multilayer Ceramic Capacitors, Polymer Capacitors, EMI Suppression Filters (Three-terminal Capacitors, Ferrite Beads) and Power/RF Inductors.

■ Components performance simulator
 You can search by the simulation on simple circuits for Thermistors.

■ Selection tool
 You can select Medium voltage Capacitors and Power Inductors according to conditions of use.
 * Medium voltage: Rated Voltage 250V and over

■ Search tool
 You can search the Murata timing device (CERALOCK® and crystal units) that is most suitable for your IC and access information about the recommended circuit constant setting.

If you register as a "my Murata" user (<https://my.murata.com/en/web/mymurata/>), you can use Enhanced SimSurfing.

■ Usage example of "Multilayer Ceramic Capacitors"

1 Select the products

- (1) By performance/type
- (2) By part number

2 Show graph

Click each button on each tab of [Basic], [S-parameter] and [Detailed].

3 Data download

- Click each purple button in this area.
- Click "CSV output" button.

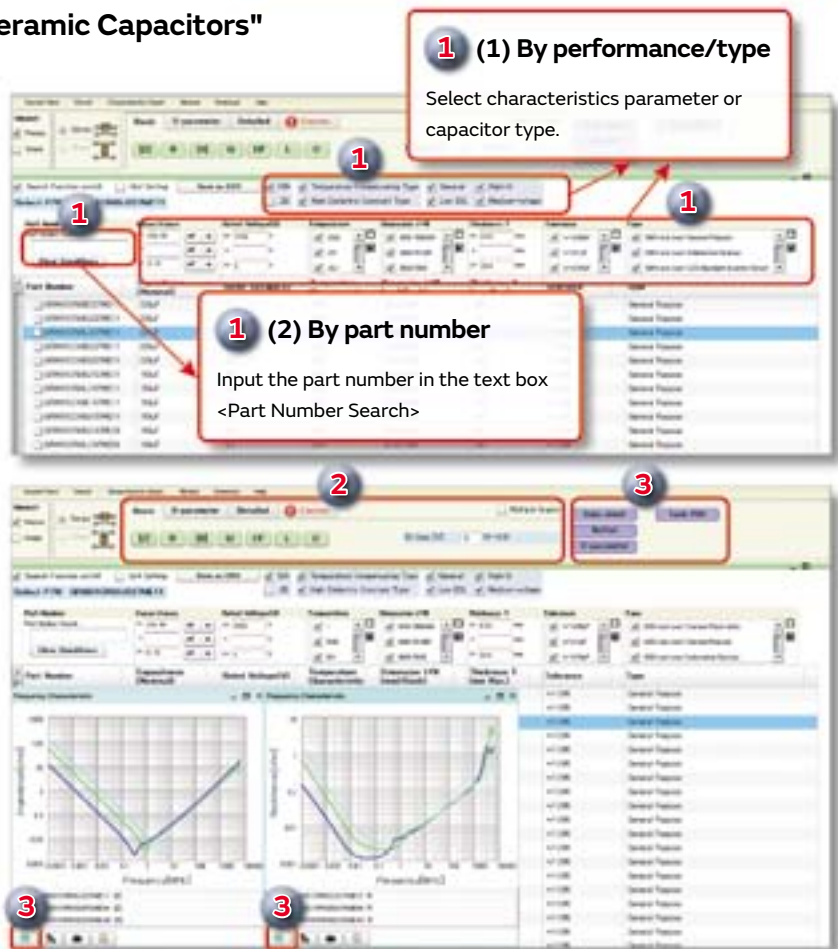

1 (1) By performance/type
 Select characteristics parameter or capacitor type.

1 (2) By part number
 Input the part number in the text box <Part Number Search>

2
 Click each button on each tab of [Basic], [S-parameter] and [Detailed].

3
 Click each purple button in this area. Click "CSV output" button.

* Images are as of October 2015. Be assured that this software will be updated frequently.

<https://www.murata.com/simsurfing/>

Web page Introduction



Search by Part Number

<https://www.murata.com/search/productsearch?cate=cgsubCeramicCapacitors>



You can search for capacitors by specifying the alphanumeric characters in the part number. The packing codes shown contain the substitute character "#". If you enter the official packing code, part numbers that contain that packing code will be matched.



Search by Specifications

<https://www.murata.com/search/productsearch?cate=luCeramicCapacitorsSMD#spec>



You can search for SMD, lead type, or screw termination type capacitors by indicating specifications such as application, capacitance, rated voltage, or temperature characteristics.

You can narrow your search by entering values of ranges, and by specifying product characteristics.

The items for narrowing searches are linked, so specifying one condition causes selectable options for the other items to allow input only of conditions that match the relevant part numbers.



Search in the Lineups

<https://www.murata.com/products/capacitor/mlcc/lineup>

You can search for capacitors by specifying the series lineup.

You can also confirm items such as characteristics and applications on each series page.



Capacitance chart in Series page.



[Search result]

Compares the characteristics of the checked part numbers.

Displays the number of hits for the current search conditions in real time.

Click the ▲ mark for each item to switch between ascending and descending display.

Click a product name to display a details page listing more in-depth information (→ P36).

You can download detailed spec sheets.

For some products it is possible to request a free sample.

Icons enable you to check the status and characteristics of products at a glance.

You narrow the search results to match the selected condition in real time.

You can confirm the current conditions for narrowing the search results.

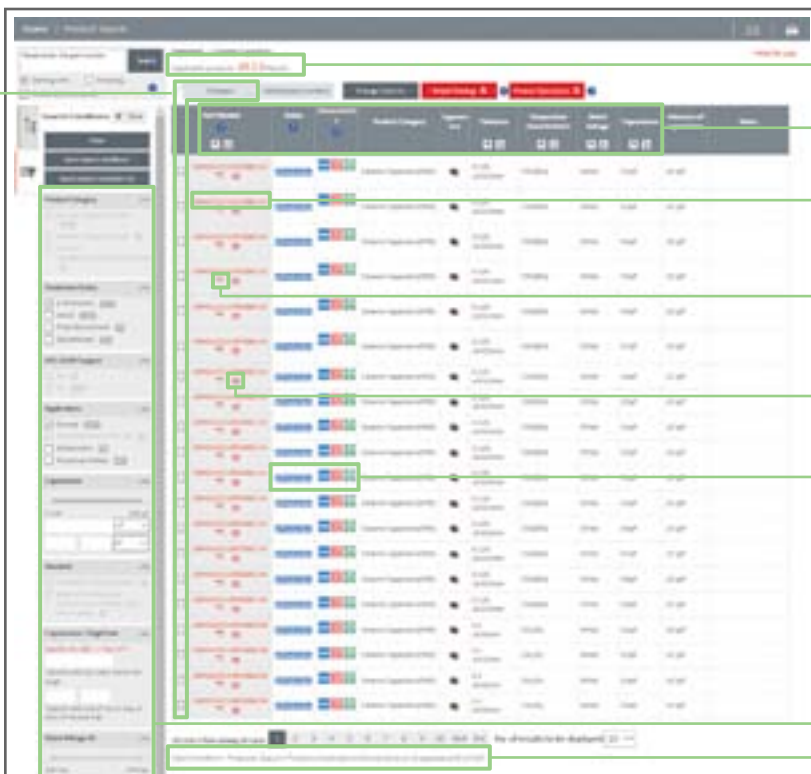

Global Locations

For details please visit www.murata.com



⚠ Note

1 Export Control

For customers outside Japan:

No Murata products should be used or sold, through any channels, for use in the design, development, production, utilization, maintenance or operation of, or otherwise contribution to (1) any weapons (Weapons of Mass Destruction [nuclear, chemical or biological weapons or missiles] or conventional weapons) or (2) goods or systems specially designed or intended for military end-use or utilization by military end-users.

For customers in Japan:

For products which are controlled items subject to the "Foreign Exchange and Foreign Trade Law" of Japan, the export license specified by the law is required for export.

2 Please contact our sales representatives or product engineers before using the products in this catalog for the applications listed below, which require especially high reliability for the prevention of defects which might directly damage a third party's life, body or property, or when one of our products is intended for use in applications other than those specified in this catalog.

- ① Aircraft equipment
- ② Aerospace equipment
- ③ Undersea equipment
- ④ Power plant equipment
- ⑤ Medical equipment
- ⑥ Transportation equipment (vehicles, trains, ships, etc.)
- ⑦ Traffic signal equipment
- ⑧ Disaster prevention / crime prevention equipment
- ⑨ Data-processing equipment
- ⑩ Application of similar complexity and/or reliability requirements to the applications listed above

3 Product specifications in this catalog are as of January 2020. They are subject to change or our products in it may be discontinued without advance notice. Please check with our sales representatives or product engineers before ordering. If there are any questions, please contact our sales representatives or product engineers.

4 Please read rating and ⚠CAUTION (for storage, operating, rating, soldering, mounting and handling) in this catalog to prevent smoking and/or burning, etc.

5 This catalog has only typical specifications. Therefore, please approve our product specifications or transact the approval sheet for product specifications before ordering.

6 Please note that unless otherwise specified, we shall assume no responsibility whatsoever for any conflict or dispute that may occur in connection with the effect of our and/or a third party's intellectual property rights and other related rights in consideration of your use of our products and/or information described or contained in our catalogs. In this connection, no representation shall be made to the effect that any third parties are authorized to use the rights mentioned above under licenses without our consent.

7 No ozone depleting substances (ODS) under the Montreal Protocol are used in our manufacturing process.

Murata Manufacturing Co., Ltd.

www.murata.com

muRata
INNOVATOR IN ELECTRONICS

Mouser Electronics

Authorized Distributor

Click to View Pricing, Inventory, Delivery & Lifecycle Information:

Murata:

[GR731CR72E153KW03L](#) [GR731CR72E223KW03L](#) [GJM-KIT-B](#) [GR732DR72E473KW01L](#) [GJM15-KIT-TTOL---E](#)
[GR355XD72J274KW05L](#) [GJM03-KIT-TTOL---E](#) [GJM15-KIT-DE-1](#) [GJM03-KIT-DE-2](#) [GJM03-KIT-DE-1](#) [GJM15-KIT-](#)
[DE-2](#) [GCM-KIT-C0G-DE](#) [MKV250V-KIT-2-DE](#) [GCM-KIT-X7-DE](#) [DHR-KIT-DE](#) [MKV250V-KIT-3-DE](#) [MKV250V-KIT-4-](#)
[DE](#) [MKV250V-KIT-1-DE](#)