

High Efficacy
Dental Blue LED Emitter
LZ4-00DB10



Key Features

- High Efficacy 10W Dental Blue LED
- Ultra-small foot print – 7.0mm x 7.0mm x 4.1mm
- Surface mount ceramic package with integrated glass lens
- Very low Thermal Resistance (3°C/W)
- Individually addressable die
- Very high Radiant Flux density
- New industry standard for Radiant Flux Maintenance (>90% at 100,000 Hours)
- JEDEC Level 2 for Moisture Sensitivity Level
- Autoclave complaint (JEDEC JESD22-A102-C)
- Lead (Pb) free and RoHS compliant
- Reflow solderable (up to 6 cycles)
- Emitter available on [Standard MCPCB](#) (optional)

Typical Applications

- Dental Curing
- Teeth Whitening

Description

The LZ4-00DB10 Dental Blue LED emitter provides superior radiometric power in the wavelength range specifically required for dental curing light applications. With a 7.0mm x 7.0mm x 4.1mm ultra-small footprint, this package provides exceptional optical power density making it ideal for use in dental curing devices. The radiometric power performance and optimal peak wavelength of this LED are matched to the response curves of many dental resins, resulting in a significantly reduced curing time. LedEngin's LZ4-00DB10 offers ultimate design flexibility with individually addressable die. The patent-pending design has unparalleled thermal and optical performance. The high quality materials used in the package are chosen to optimize light output, have excellent UV resistance, and minimize stresses which results in monumental reliability and radiant flux maintenance.

Table of Contents

Product Nomenclature	3
IPC/JEDEC Moisture Sensitivity	3
Average Radiant Flux Maintenance Projections	3
Radiant Flux Binning	4
Peak Wavelength Binning	4
Forward Voltage Binning	4
Absolute Maximum Ratings	5
Optical Characteristics	5
Electrical Characteristics	5
Mechanical Dimensions	6
Pin-Out	6
Recommended Solder Pad Layout	6
Reflow Soldering Profile	7
Typical Radiation Pattern	7
Typical Relative Spectral Power Distribution	8
Typical Peak Wavelength Shift over Temperature.	8
Typical Normalized Radiant Flux	9
Typical Normalized Radiant Flux over Temperature	9
Typical Forward Current Characteristics	10
Current Derating Curves	10
Emitter Tape & Reel Specifications	11
Company Information	12

Product Nomenclature

The LZ Series part number designation is defined as follows:



Where:

- A – designates the number of LED die in the package (“4” for 10W)
- B – designates the package level (“0” for Emitter)
- C – designates the radiation pattern (“0” for Lambertian)
- D and E – designate the color (“DB” for Dental Blue – 460nm Peak Wavelength)
- F and G – designate the Power (“10” for 10W typical rating)
- H – designates the Radiant Flux bin (See Table 2)
- J and K – designate the Peak Wavelength bin (see Table 3)
- L – designates the V_F bin (See Table 4)

Ordering information:

For ordering LedEngin products, please reference the base part number. The base part number represents any of the radiant flux bins specified in the binning tables below. For ordering products with special bin selections, please contact a LedEngin sales representative or authorized distributor.

IPC/JEDEC Moisture Sensitivity Level

Table 1 - IPC/JEDEC J-STD MSL-20 Classification:

Level	Floor Life		Soak Requirements			
	Time	Conditions	Standard	Standard	Accelerated	Accelerated
	Time	Conditions	Time (hrs)	Conditions	Time (hrs)	Conditions
2	1 Year	≤ 30°C/ 60% RH	168 +5/-0	30°C/ 60% RH	n/a	n/a

Notes for Table 1:

1. The standard soak time is the sum of the default value of 24 hours for the semiconductor manufacturer’s exposure time (MET) between bake and bag and the floor life of maximum time allowed out of the bag at the end user of distributor’s facility.

Average Radiant Flux Maintenance Projections

Based on long-term WHTOL testing, LedEngin projects that the LZ Series will deliver, on average, 90% Radiant Flux Maintenance at 100,000 hours of operation at a forward current of 700 mA. This projection is based on constant current operation with junction temperature maintained at or below 125°C.

Radiant Flux Bins

Table 2:

Bin Code	Minimum Radiant Flux (Φ) @ $I_F = 700\text{mA}$ ^[1,2] (W)	Maximum Radiant Flux (Φ) @ $I_F = 700\text{mA}$ ^[1,2] (W)	Typical Radiant Flux (Φ) @ $I_F = 1000\text{mA}$ ^[2] (W)
Q	2.0	2.4	2.7
R	2.4	3.0	3.4
S	3.0	3.8	4.2

Notes for Table 2:

1. Radiant flux performance guaranteed within published operating conditions. LedEngin maintains a tolerance of $\pm 10\%$ on flux measurements.
2. Future products will have even higher levels of radiant flux performance. Contact LedEngin Sales for updated information.

Peak Wavelength Bin

Table 3:

Bin Code	Minimum Peak Wavelength (λ_P) @ $I_F = 700\text{mA}$ ^[1] (nm)	Maximum Peak Wavelength (λ_P) @ $I_F = 700\text{mA}$ ^[1] (nm)
D1	457	463

Notes for Table 3:

1. LedEngin maintains a tolerance of $\pm 2.0\text{nm}$ on peak wavelength measurements.

Forward Voltage Bin

Table 4:

Bin Code	Minimum Forward Voltage (V_F) @ $I_F = 700\text{mA}$ ^[1,2] (V)	Maximum Forward Voltage (V_F) @ $I_F = 700\text{mA}$ ^[1,2] (V)
0	12.80	15.68

Notes for Table 4:

1. LedEngin maintains a tolerance of $\pm 0.04\text{V}$ for forward voltage measurements.
2. Forward Voltage is binned with all four LED dice connected in series.

Absolute Maximum Ratings

Table 5:

Parameter	Symbol	Value	Unit
DC Forward Current ^[1]	I_F	1000	mA
Peak Pulsed Forward Current ^[2]	I_{FP}	1500	mA
Reverse Voltage	V_R	See Note 3	V
Storage Temperature	T_{stg}	-40 ~ +150	°C
Junction Temperature	T_J	150	°C
Soldering Temperature ^[4]	T_{sol}	260	°C
Allowable Reflow Cycles		6	
Autoclave Conditions ^[5]		121°C at 2 ATM, 100% RH for 168 hours	
ESD Sensitivity ^[6]		> 8,000 V HBM Class 3B JESD22-A114-D	

Notes for Table 5:

- Maximum DC forward current is determined by the overall thermal resistance and ambient temperature. Follow the curves in Figure 10 for current derating.
- Pulse forward current conditions: Pulse Width \leq 10msec and Duty Cycle \leq 10%.
- LEDs are not designed to be reverse biased.
- Solder conditions per JEDEC 020c. See Reflow Soldering Profile Figure 3.
- Autoclave Conditions per JEDEC JESD22-A102-C.
- LedEngin recommends taking reasonable precautions towards possible ESD damages and handling the LZ4-00DB10 in an electrostatic protected area (EPA). An EPA may be adequately protected by ESD controls as outlined in ANSI/ESD S6.1.

Optical Characteristics @ $T_C = 25^\circ\text{C}$

Table 6:

Parameter	Symbol	Typical	Unit
Radiant Flux (@ $I_F = 700\text{mA}$) ^[1]	Φ	2.6	W
Radiant Flux (@ $I_F = 1000\text{mA}$) ^[1]	Φ	3.2	W
Peak Wavelength ^[2]	λ_P	460	nm
Viewing Angle ^[3]	$2\Theta_{1/2}$	110	Degrees
Total Included Angle ^[4]	$\Theta_{0.9}$	120	Degrees

Notes for Table 6:

- Radiant flux typical value is for all four LED dice operating concurrently at rated current.
- Observe IEC 60825-1 class 2 rating for eye safety. Do not stare into the beam.
- Viewing Angle is the off axis angle from emitter centerline where the radiant power is $\frac{1}{2}$ of the peak value.
- Total Included Angle is the total angle that includes 90% of the total radiant flux.

Electrical Characteristics @ $T_C = 25^\circ\text{C}$

Table 6:

Parameter	Symbol	Typical		Unit
		1 Die	4 Dice	
Forward Voltage (@ $I_F = 700\text{mA}$)	V_F	3.5	14.0	V
Forward Voltage (@ $I_F = 1000\text{mA}$)	V_F	3.7	14.6	V
Temperature Coefficient of Forward Voltage	$\Delta V_F/\Delta T_J$	-10.4		mV/°C
Thermal Resistance (Junction to Case)	$R\Theta_{J-C}$	3		°C/W

Mechanical Dimensions (mm)

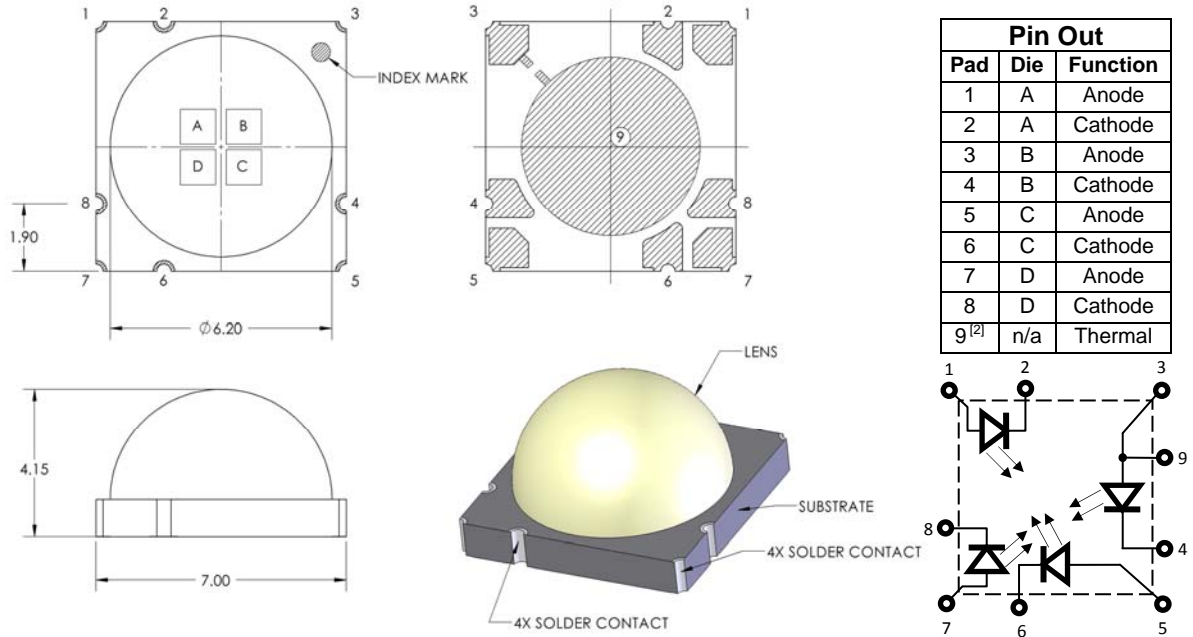

Figure 1: Package outline drawing.

Notes for Figure 1:

1. Unless otherwise noted, the tolerance = ± 0.20 mm.
2. Thermal contact, Pad 9, is electrically connected to Pad 3. Do not connect any pad to the thermal contact, Pad 9. When mounting the LZ4-00DB10 onto a MCPCB, by default its dielectric layer provides for the necessary electrical insulation in between all contact pads. LedEngin offers a [LZ4-20DB10](#) MCPCB option which provides for electrical insulation between all contact pads. Please refer to Application Note MCPCB Option 2, or contact a LedEngin sales representative for more information.

Recommended Solder Pad Layout (mm)

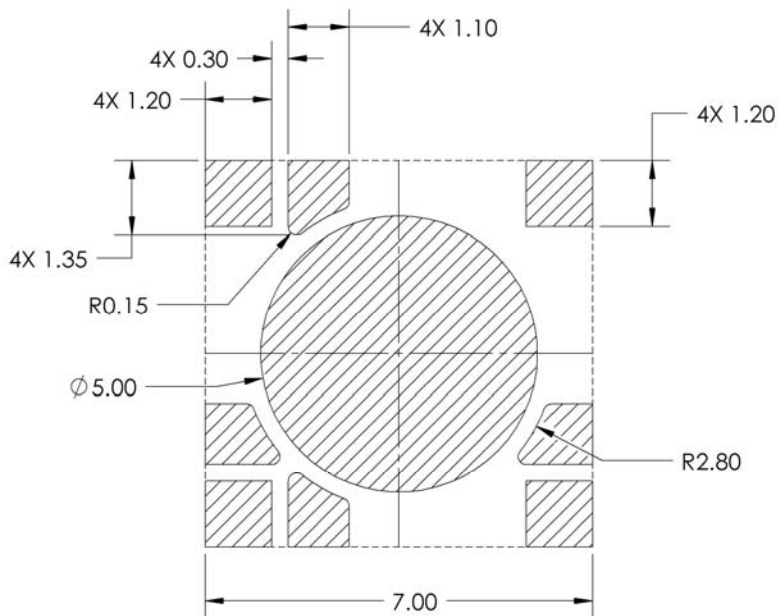

Figure 2: Recommended solder mask opening (hatched area) for anode, cathode, and thermal pad.

Note for Figure 2:

1. Unless otherwise noted, the tolerance = ± 0.20 mm.

Reflow Soldering Profile

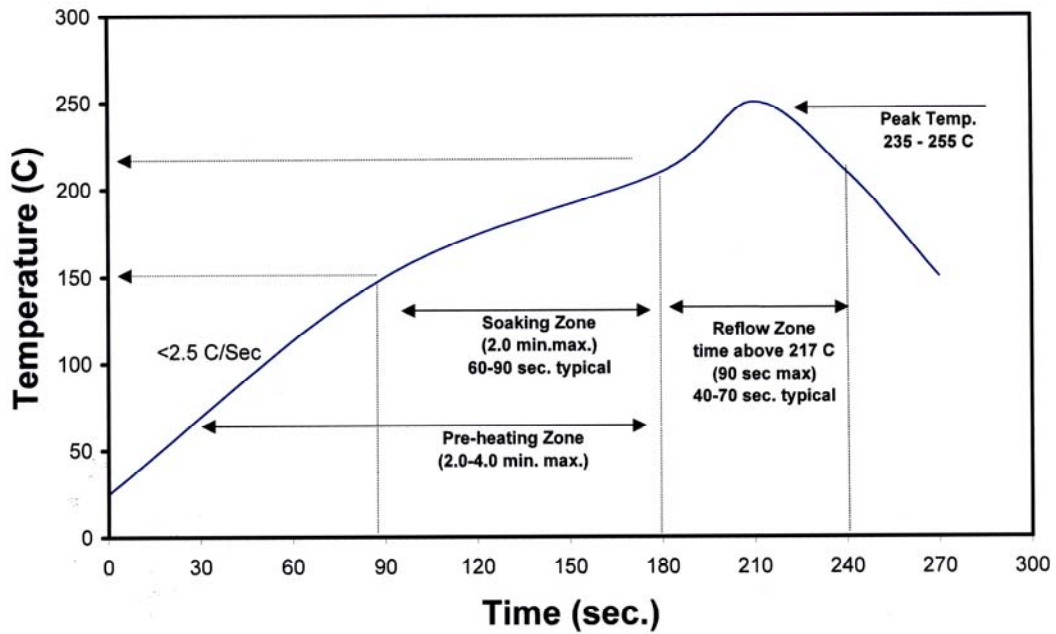

Figure 3: Reflow soldering profile for lead free soldering.

Typical Radiation Pattern

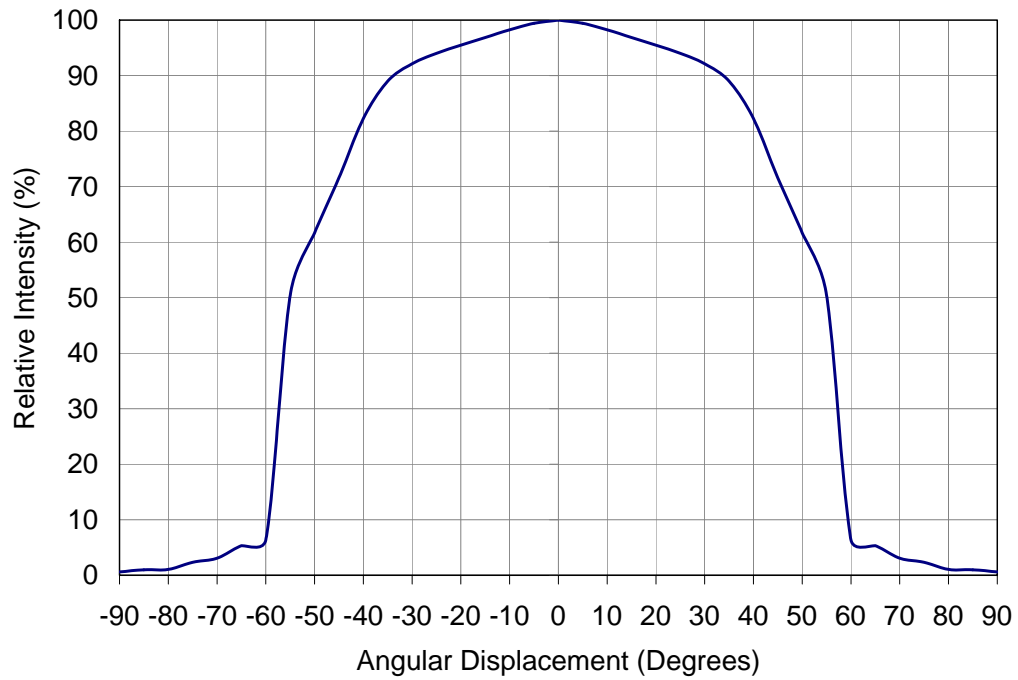

Figure 4: Typical representative spatial radiation pattern.

Typical Relative Spectral Power Distribution

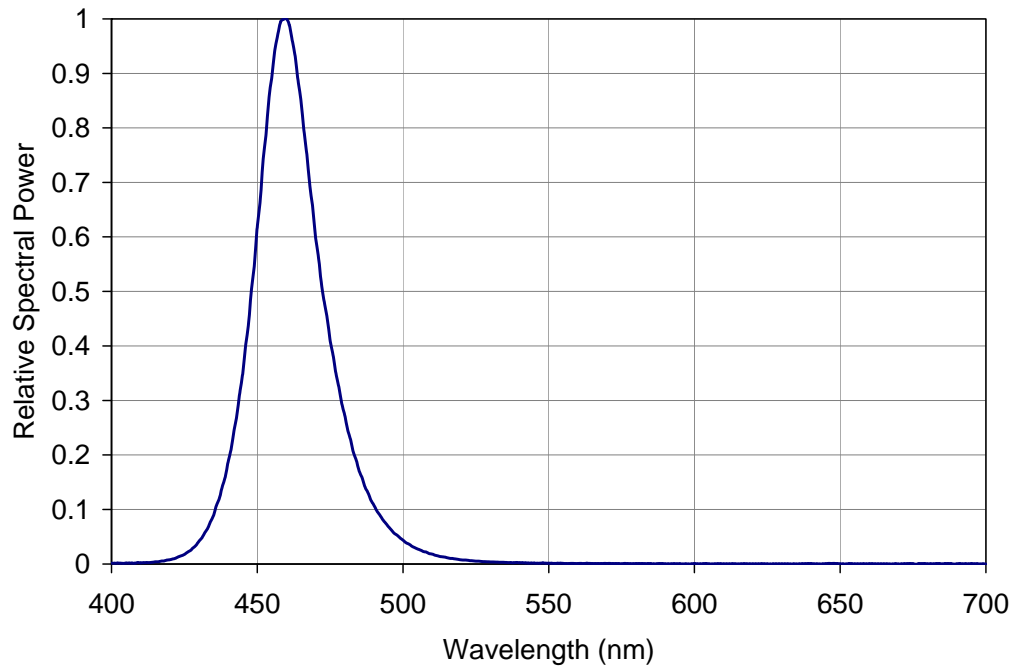

Figure 5: Typical relative spectral power vs. wavelength @ $T_c = 25^\circ\text{C}$.

Typical Peak Wavelength Shift over Temperature

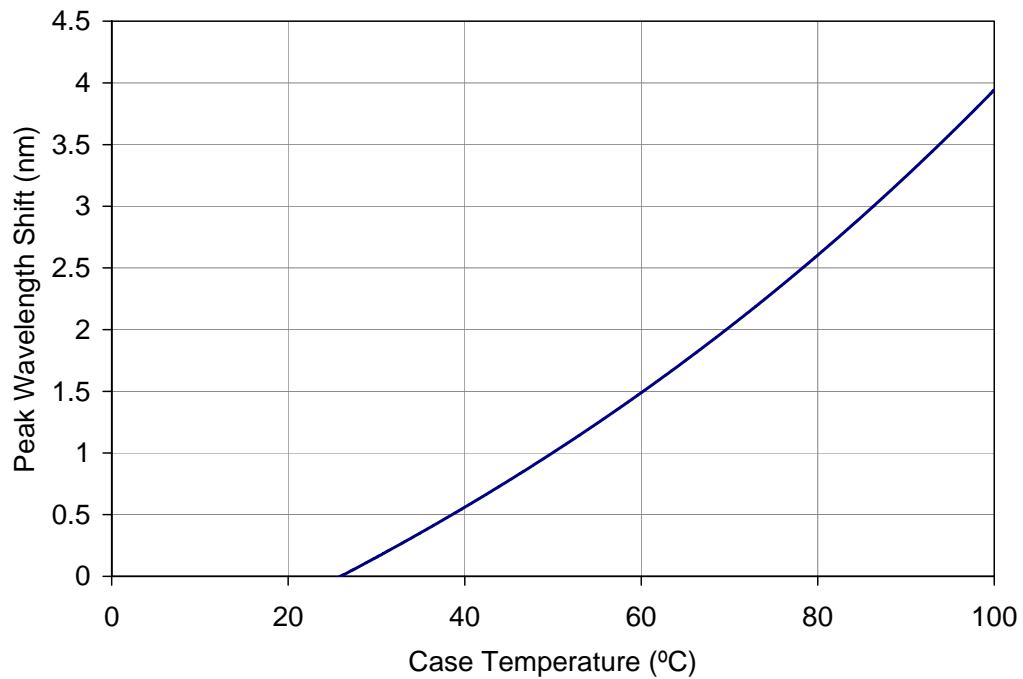

Figure 6: Typical peak wavelength shift vs. case temperature.

Typical Normalized Radiant Flux

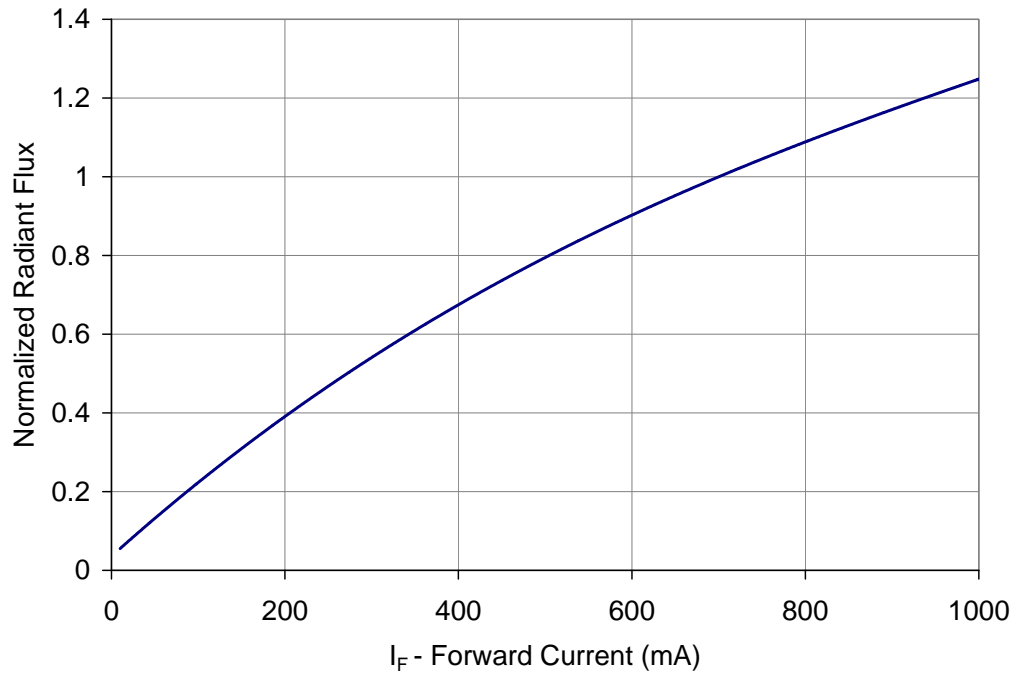

Figure 7: Typical normalized radiant flux vs. forward current @ $T_C = 25^\circ\text{C}$.

Typical Normalized Radiant Flux over Temperature

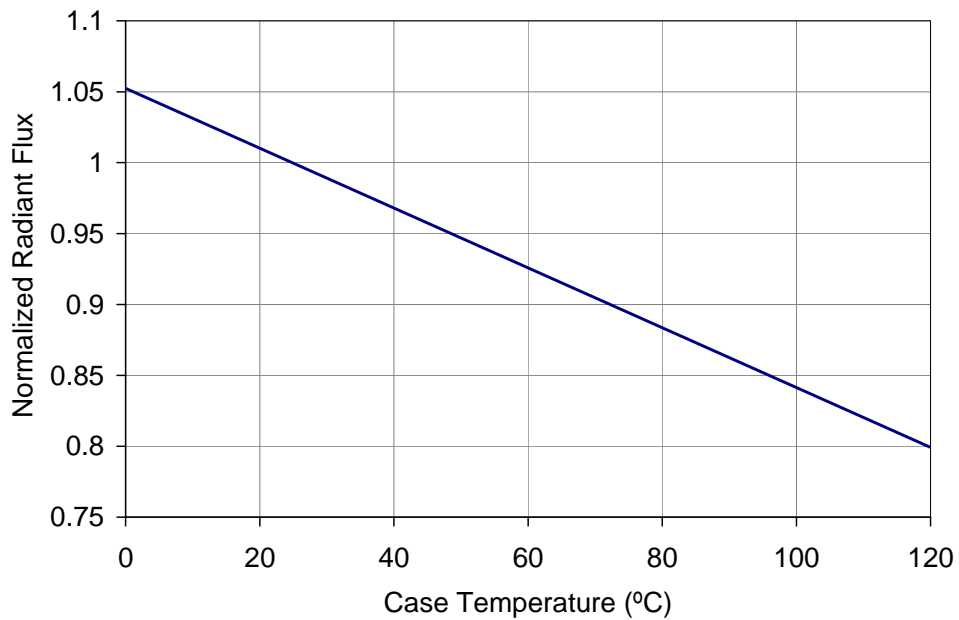

Figure 8: Typical normalized radiant flux vs. case temperature.

Typical Forward Current Characteristics

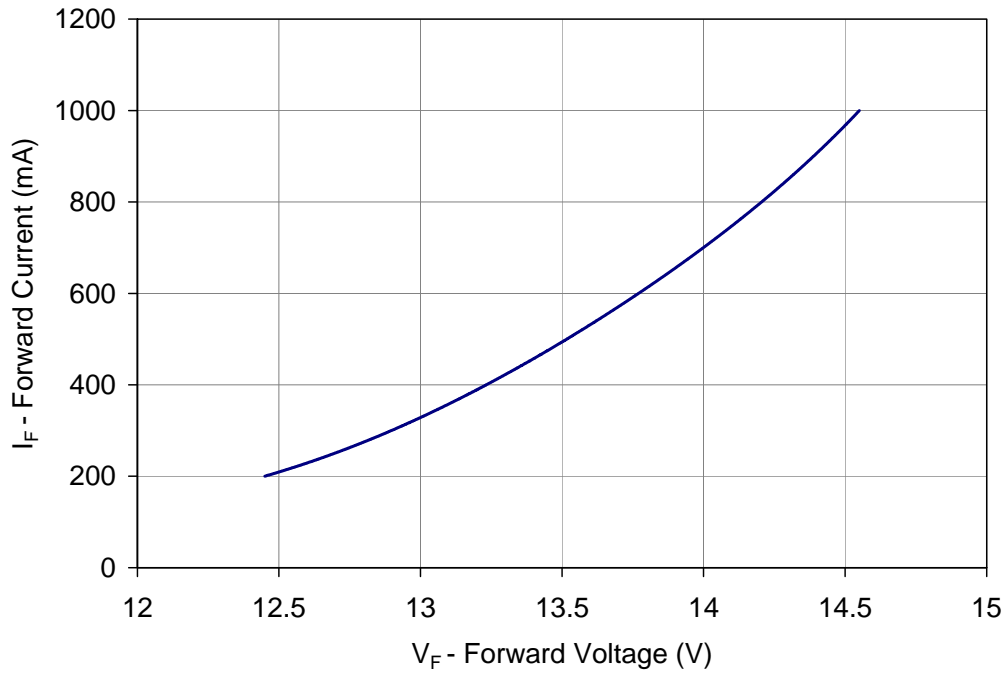

Figure 9: Typical forward current vs. forward voltage @ $T_C = 25^\circ\text{C}$.

Current Derating

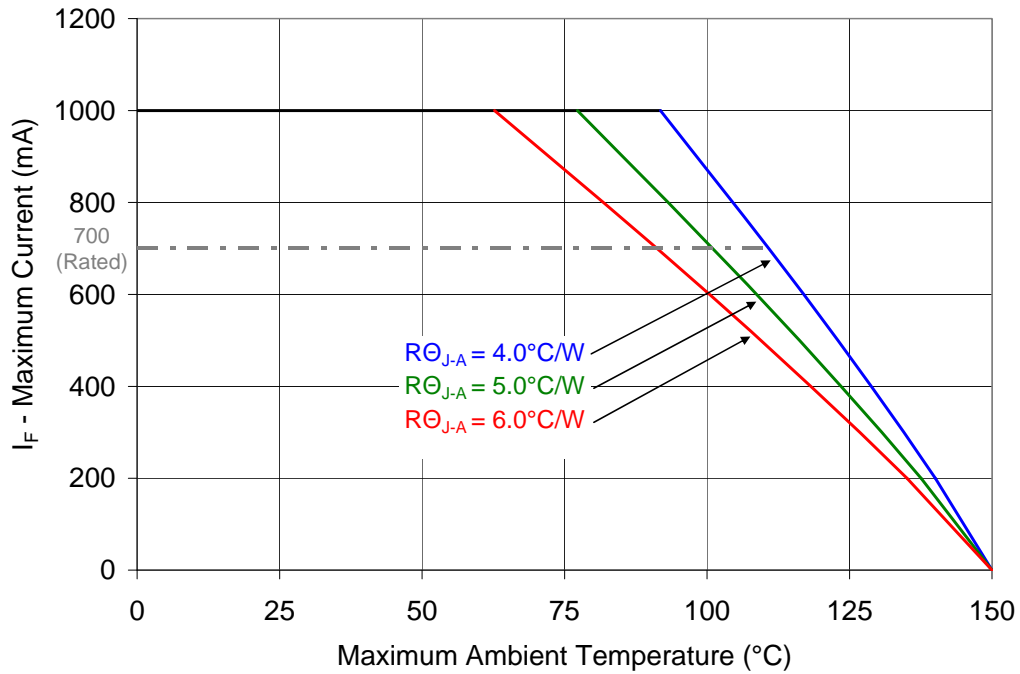

Figure 10: Maximum forward current vs. ambient temperature based on $T_{J(MAX)} = 150^\circ\text{C}$.

Notes for Figure 10:

1. $R_{\theta_{J-C}}$ [Junction to Case Thermal Resistance] for the LZ4-00DB10 is typically 3.0°C/W .
2. $R_{\theta_{J-A}}$ [Junction to Ambient Thermal Resistance] = $R_{\theta_{J-C}} + R_{\theta_{C-A}}$ [Case to Ambient Thermal Resistance].

Emitter Tape and Reel Specifications (mm)

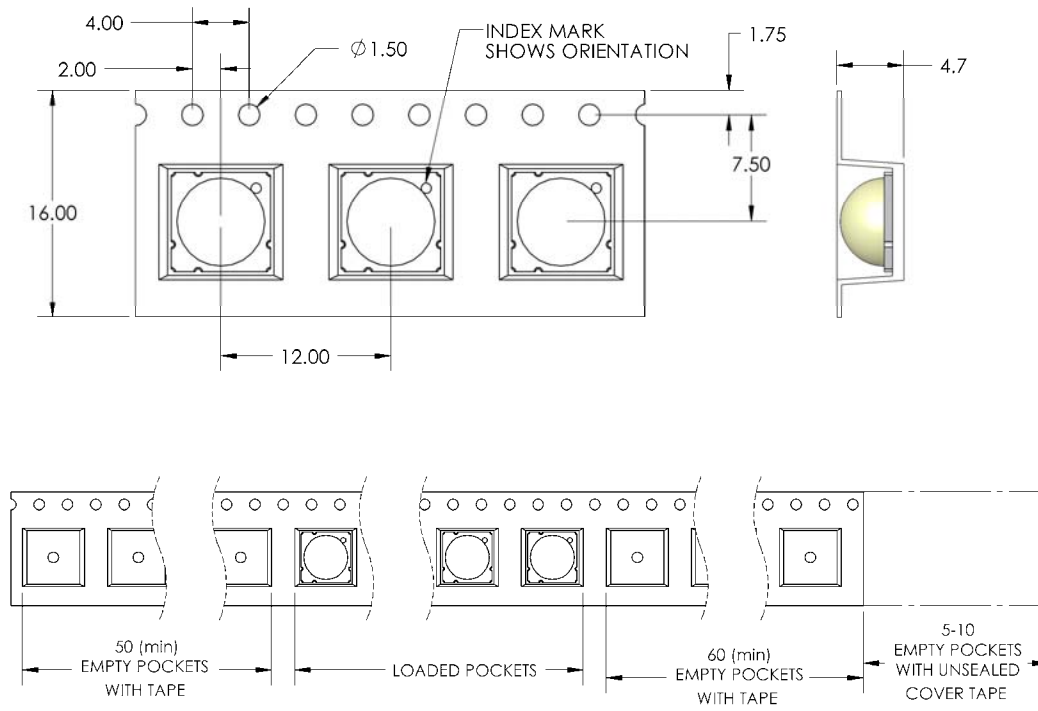

Figure 11: Emitter carrier tape specifications (mm).

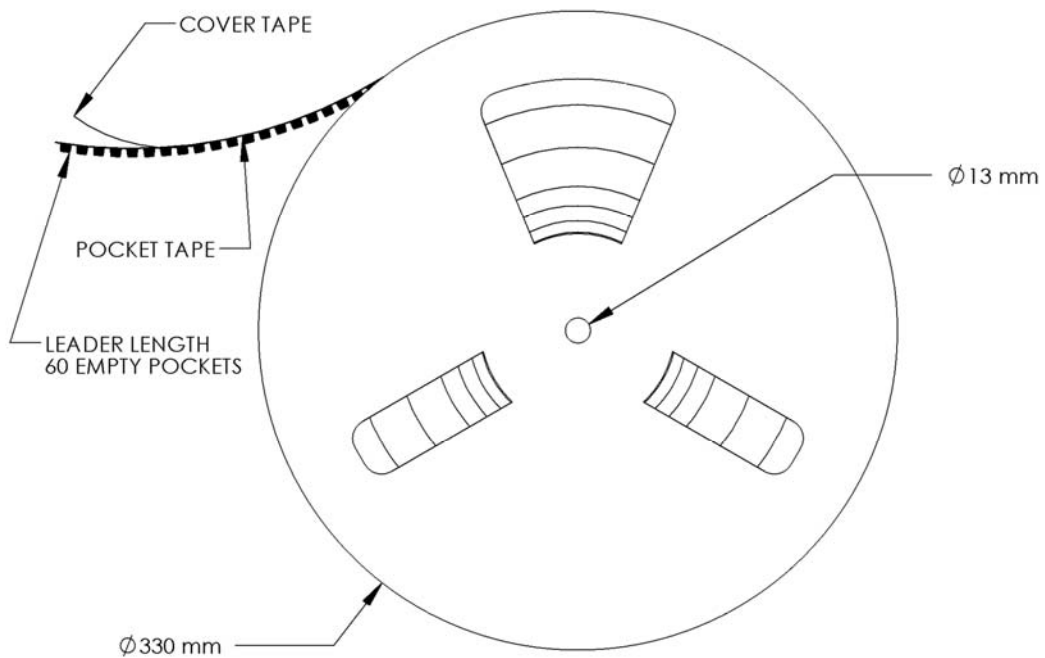

Figure 12: Emitter Reel specifications (mm).

Company Information

The LZ4-00DB10 Dental Blue LED emitter is developed, manufactured, and marketed by LedEngin, Inc., located in Santa Clara, CA. LedEngin is a global market leader in advanced high-power LED emitters and light-source modules. LedEngin provides total solutions from 3W to 15W in single packages with ultra-small footprints in all colors from White, Dental Blue, Blue, Green, Red, RGB, and UV. LedEngin supports customers to generate solid-state lighting designs that conserve natural resources. LedEngin is focused on differentiated Ultra High-Brightness LED solutions for diverse global markets using its patent-pending package designs and manufacturing processes. LedEngin offers catalog as well as full custom solutions to enable flexible system designs for its customers. LedEngin is dedicated to long-term win-win partnering with its customers and suppliers.

LedEngin reserves the right to make changes to improve performance without notice.

Please contact Sales@ledengin.com for more information.

Mouser Electronics

Authorized Distributor

Click to View Pricing, Inventory, Delivery & Lifecycle Information:

[LED Engin:](#)

[LZ4-40DB10](#) [LZ4-00DB10](#) [LZ4-20DB10](#)