

High Efficiency TIR Lenses for LZC Emitter Family

LLNF-3T08-H, LLFL-5T08-H, LLWF-3T08-H



Key Features

- Total Internal Reflection (TIR) optics provides a well-controlled beam
- Designed specifically for LED Engin LZC 12-die emitter family
- Maximum Lux on Target™ and lumens in beam
- Provides the highest quality and quantity of light in a beam
- Smooth light gradient eliminates hot spots and rings and minimizes glare for superior illumination
- UL-rated optical grade PMMA lens material allows use of high current and temperature conditions
- Lenses are available standard with holder that mount easily onto LuxiGen LZC MCPCBs
- Simple fastening of holder to MCPCB with appropriate adhesive, e.g. epoxy or polyurethane based

Typical Applications

- Down lighting
- Accent lighting
- Track lighting
- Architectural lighting
- Stage and Studio lighting

Description

This lens family couples with the compact, high-flux density LZC LuxiGen emitter family providing a range of beam options and opening up new applications in stage and studio, architectural and down lighting. The TIR lens collimates the LED light into efficient, well-controlled light beams that maximize the usable lumens in the target area. Not only does this lighting solution provide the throw or distance required for these lighting applications, it does so with a smooth, high quality beam of superior intensity uniformity, color over angle mixing, and with an absence of discomfort glare or shadows.

Optical Specification

Part number ¹	Beam angle ²	Field angle ³	Optical efficiency ⁴	On-axis intensity ⁵
	degrees	degrees	%	cd/lm
LLNF-3T08-H	20	43	90	3.9
LLFL-5T08-H	32	74	90	1.7
LLWF-3T08-H	50	87	90	1.1

Notes:

1. Lenses can also be ordered without the holder. Replace -H with -O for this option.
2. Beam angle is defined as the full width at 50% of the max intensity (FWHM).
3. Field angle is defined as the full width at 10% of the max intensity.
4. Optical efficiency is defined as the ratio between the incoming flux and the outgoing flux.
5. On-axis intensity is defined as the ratio between the total input lumen and the intensity in the optical center of the lens.

Typical Relative Intensity over Angle

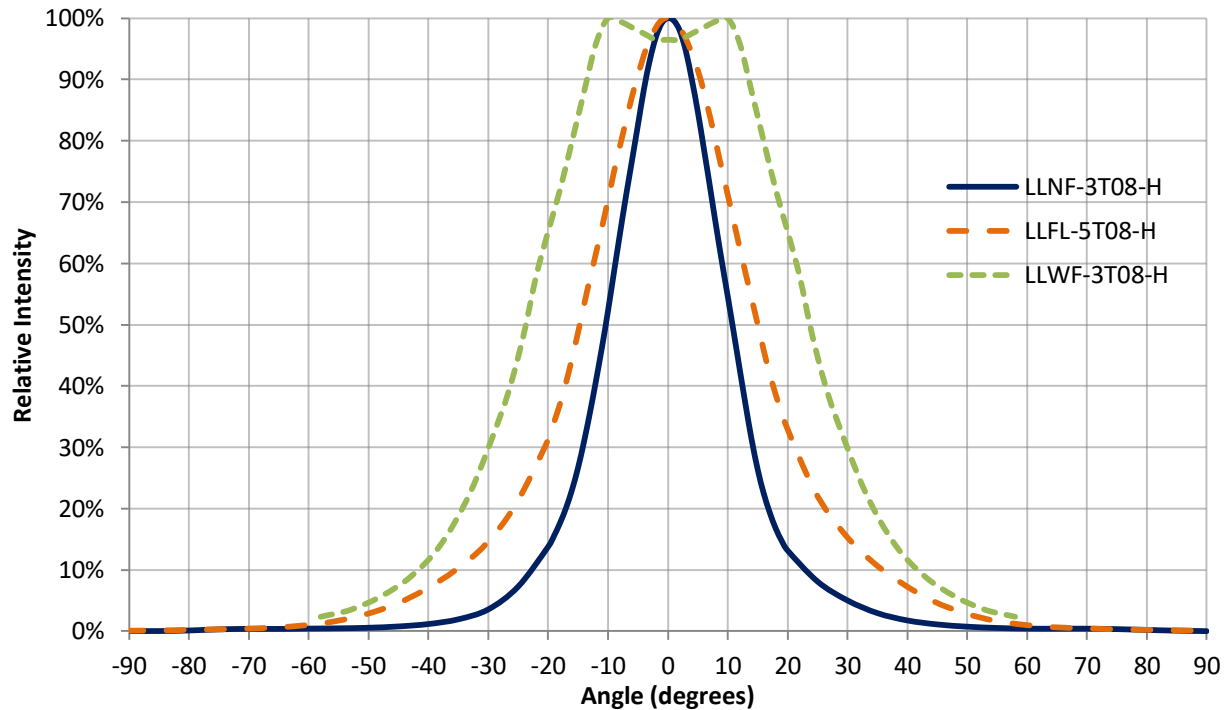

General Characteristics

	Symbol	Value	Rating	Unit
Mechanical				
Height from Seating Plane		26.3	Typical	mm
Diameter		47.5	Typical	mm
Material				
Lens		PMMA		
Holder		Polycarbonate		
Optical				
Transmission ¹ (>90%)	λ	410-1100	Min-Max.	nm
Environmental				
Storage Temperature	T_{stg}	-40 ~ +110	Min-Max.	°C
Operating Temperature	T_{sol}	-40 ~ +110	Min-Max.	°C

Notes:

1. It is not recommended to use a UV emitter with this lens due to lower transmission at wavelengths < 410nm.

Mechanical dimensions

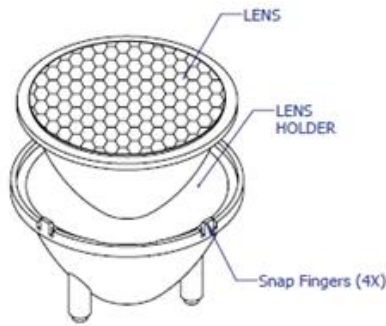

Lens with Holder

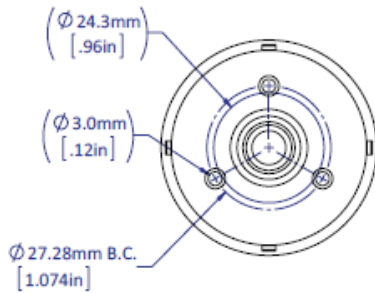
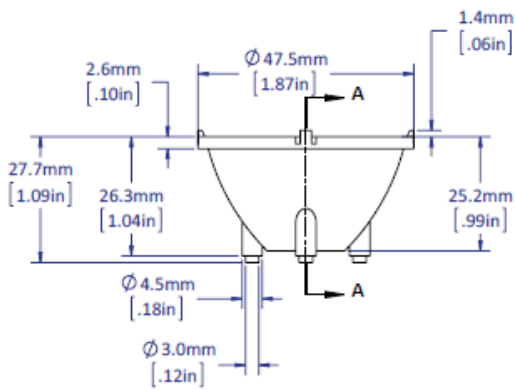

Lens only

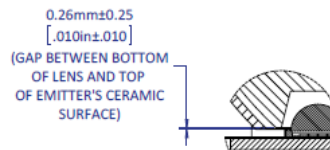
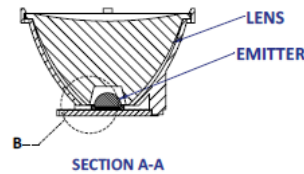
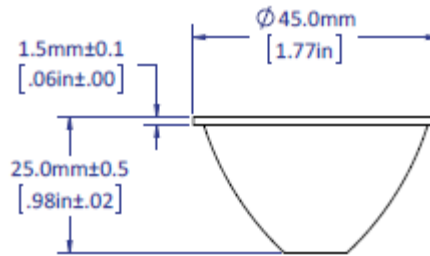

DETAIL B
SCALE 3 : 1

Assembly Instruction

Lens holders can be assembled to the PCB using an epoxy or polyurethane-based adhesive (example: Dow Corning 3145 RTV).

Cyanoacrylate (superglue) adhesive should not be used to avoid contamination of the lens (blooming of the epoxy).

When integrating the lens into a fixture without the lens holder, special attention is needed to maintain the distance between the lens bottom and the emitter top. Variation in this distance will result in variation of the beam profile. See mechanical detail B. on previous page.

Lens Cleaning

Use a lint-free soft cloth to dust off the lens. For deeper cleaning a solution of neutral detergent (example: dishwashing soap) can be used. Do not use any solvents or abrasive liquid/fabric.

About LED Engin

LED Engin, an OSRAM business based in California's Silicon Valley, develops, manufactures, and sells advanced LED emitters, optics and light engines to create uncompromised lighting experiences for a wide range of entertainment, architectural, general lighting and specialty applications. LuxiGen™ multi-die emitter and secondary lens combinations reliably deliver industry-leading flux density, upwards of 5000 quality lumens to a target, in a wide spectrum of colors including whites, tunable whites, multi-color and UV LEDs in a unique patented compact ceramic package. Our LuxiTune™ series of tunable white lighting modules leverage our LuxiGen emitters and lenses to deliver quality, control, freedom and high density tunable white light solutions for a broad range of new recessed and downlighting applications. The small size, yet remarkably powerful beam output and superior in-source color mixing, allows for a previously unobtainable freedom of design wherever high-flux density, directional light is required. LED Engin is committed to providing products that conserve natural resources and reduce greenhouse emissions; and reserves the right to make changes to improve performance without notice.

For more information, please contact sales@ledengin.com or +1 408 922-7200.

Mouser Electronics

Authorized Distributor

Click to View Pricing, Inventory, Delivery & Lifecycle Information:

[LED Engin:](#)

[LLNF-3T08-H](#) [LLWF-3T08-H](#) [LLFL-5T08-H](#)