



# FLTR75V05 Filter Module 75 Vdc Input Maximum, 5 A Maximum

RoHS Compliant



The FLTR75V05 Filter Module is designed to reduce the conducted common-mode and differential-mode noise on input or output lines of high-frequency switching power supplies. The module has a maximum current rating of 5 A. It provides high insertion loss throughout the frequency range regulated by the U.S. Federal Communications Commission (FCC) and the International Special Committee on Radio Interference (CISPR) for conducted emissions. The module is 25.4 mm long, 25.4 mm wide, and 10.2 mm high (1.0 in. x 1.0 in. x 0.4 in.) and mounts on a PC board in a natural convection or forced-air environment.

## Introduction

High-density power modules are usually designed to operate at a high switching frequency to reduce the size of the internal filter components. The small EMI filters internal to the modules are often inadequate to meet stringent international EMI requirements. Many high-density electronic packaging techniques can increase the noise conducted onto the modules' input and output lines. For example, the close proximity of switching components to the input pins increases internal noise coupling; and planar transformers, designed to handle high-power levels in low-profile packages, have high

interwinding capacitance that can increase common-mode current levels. Also, metal substrates used to facilitate heat transfer from the power train components to an external heat sink add to common-mode noise because of the large capacitance between switching components and the metal substrate.

Many international agencies specify conducted and radiated emissions limits for electronic products. Included among these are CISPR, FCC, VCCI, and the new CE specifications. Most agency-conducted noise limits apply only to noise currents induced onto the ac power lines in finished products. European Telecommunication Standard Instructions (ETSI) are an exception, applying CE requirements to dc supplies with cables over three meters long. Although not required to do so by agency standards, some system designers apply the conducted emissions requirements to subassemblies within the product to reduce internal interference between subsystems and to reduce the difficulty of meeting overall system requirements.

To meet these requirements, external filtering of the power module is often required. When used in conjunction with the recommended external components and layout, the Lineage Power filter

module will significantly reduce the conducted differential and common-mode noise returned to the power source. CISPR and FCC class B requirements can be met by using the filter as described in the following sections.

- RoHS compliant to Directive 2011/65/EU
- Compatible in Pb-free or SnPb reflow environment
- Small size: 25.4 mm x 25.4 mm x 10.2 mm (1.0 in. x 1.0 in. x 0.4 in.)
- Optimized for use with high-frequency switching dc-to-dc power modules
- Printed-circuit board mountable
- Operating case temperature range: -40 °C to +100 °C
- Choice of pin lengths
- Common-mode and differential-mode filtering of power supply dc input and output lines
- Distributed power architectures
- Telecom
- Datacom
- CAN/CSA C22.2 No. 60950-1-07 / UL\* 60950-1, Second Edition, dated March 27, 2007; VDE 0805 (EN60950) Licensed

## Absolute Maximum Ratings

Stresses in excess of the absolute maximum ratings can cause permanent damage to the device. These are absolute stress ratings only. Functional operation of the device is not implied at these or any other conditions in excess of those given in the operations sections of the data sheet. Exposure to absolute maximum ratings for extended periods can adversely affect device reliability.

PARAMETER	SYMBOL	MIN	MAX	UNIT
Input Voltage:				
Continuous	V <sub>I</sub>	—	75	V <sub>dc</sub>
Transient (100 ms)	V <sub>I, trans</sub>	—	100	V
Voltage from GND to Either Input Lead	—	—	1500	V <sub>dc</sub>
Operating Case Temperature	T <sub>c</sub>	T <sub>c</sub>	100	°C
Storage Temperature	T <sub>stg</sub>	-55	125	°C

## Electrical Specifications

Unless otherwise indicated, specifications apply over all operating input voltage and temperature conditions.

PARAMETER	SYMBOL	MIN	TYP	MAX	UNIT
Resistance per Leg	R	—	—	20	mΩ
Maximum Average Current (T <sub>A</sub> = 92 °C, 2.0 m/s (400 lfm) air)	I <sub>max</sub>	—	—	5	A
Maximum Average Current (T <sub>A</sub> = 75 °C, natural convection)	I <sub>max</sub>	—	—	3.3	A
Common-mode Insertion Loss (50 Ω circuit, 500 kHz)	—	—	37	—	dB
Differential-mode Insertion Loss (50 Ω circuit, 500 kHz)	—	—	43	—	dB

# Characteristics

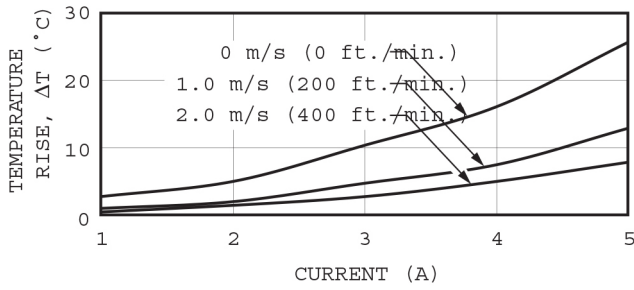

1-0352

Figure 1. Typical Case Temperature Rise vs. Average Current (Case Temperature Must Be Kept Below 100 °C)

# Internal Schematics

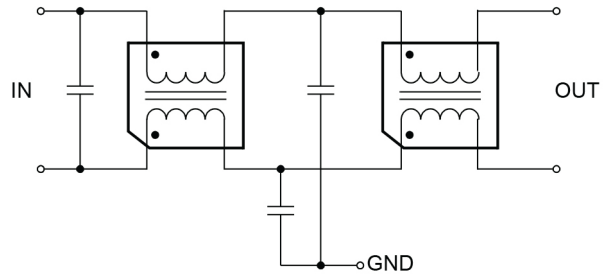

8-1324 (F).b

Figure 4. Internal Schematic

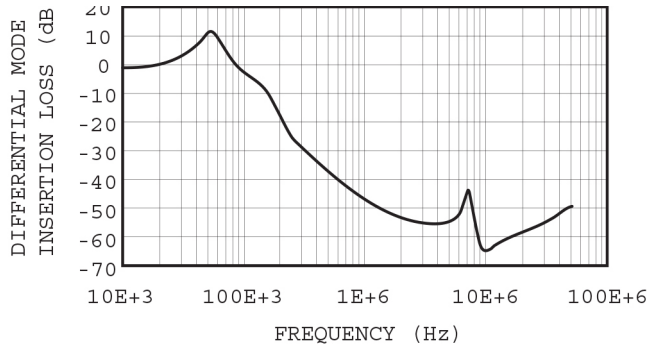
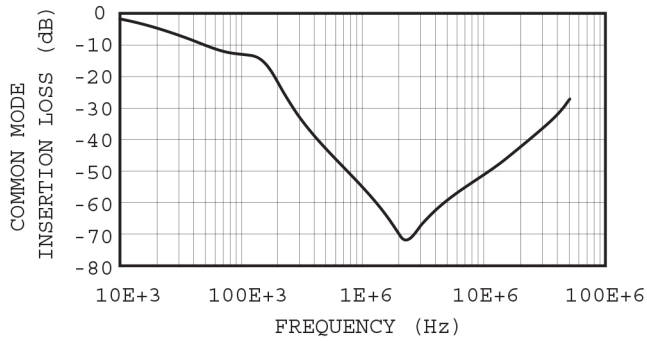

Figure 2. Typical Common-Mode Insertion Loss in a 50 Ω Circuit



1-0320

Figure 3. Typical Differential-Mode Insertion Loss in a 50 Ω Circuit

# Application

Conducted noise on the input power lines can occur as either differential-mode or common-mode noise currents. Differential-mode noise is measured between the two input lines, and is found mostly at the low-frequency end of the spectrum. This noise shows up as noise at the fundamental switching frequency and its harmonics. Common-mode noise is measured between the input lines and ground and is mostly broadband noise above 10 MHz. The high-frequency nature of common-mode noise is mostly due to the high-speed switching transitions of power train components. Either or both types of noise may be covered in a specification, as well as a combination of the two. An approved measurement technique is often described, as well.

Differential-mode noise is best attenuated using a filter composed of line-to-line capacitors (X caps) and series inductance, provided by either a discrete inductor or the leakage inductance of a common-mode choke. In addition to the differential filtering provided by the filter module, it is recommended that an electrolytic capacitor be located at the converter side of the filter to provide additional attenuation of low-frequency differential noise and to provide a low source impedance for the converter, preventing input filter oscillations and loadtransient induced input voltage dips.

Common-mode noise is best attenuated by capacitors from power module input to power module output, capacitors from each input line to a shield plane (Y caps), and common-mode chokes. It is recommended that ceramic capacitors be added around each power module from each input and output pin to a shield plane under the module. The shield plane should be connected to the CASE pin.

The GND pin of the filter module is attached to Y caps within the module. This pin should be tied to a quiet chassis ground point away from the power modules. GND of the filter module should not be tied to the CASE pin of the power module since this is a noisy node and will inject noise into the filter, increasing the input common-mode noise.

If no quiet grounding point is available, it is best to leave the filter module GND pin unattached. Each power system design will be different, and some experimentation may be necessary to arrive at the best configuration.

Figure 5 shows a typical schematic of a power module with filter module and recommended external components. Figure 6 is a proposed layout. More than one power module may be attached to a single filter

module as long as input current does not exceed 5 A. Figure 7 shows the recommended schematic for two power modules attached to a single filter.

In applications where the addition of input to output capacitors is undesirable, do not use C3 and C4 shown in Figures 5 and 6, and do not use C3, C4, C8, and C9 shown in Figure 7.

In -48 V applications where the shield plane and the power module case must be tied to a signal, remove C1 in Figures 5 and 6, remove C1 and C6 in Figure 7, and connect the shield plane and CASE pin to the VI(+) plane.

In +48 V applications where the shield plane and the power module case must be tied to a signal, remove C2 in Figures 5 and 6, remove C2 and C7 in Figure 7, and connect the shield plane and CASE pin to the VI(-) plane.

# Application

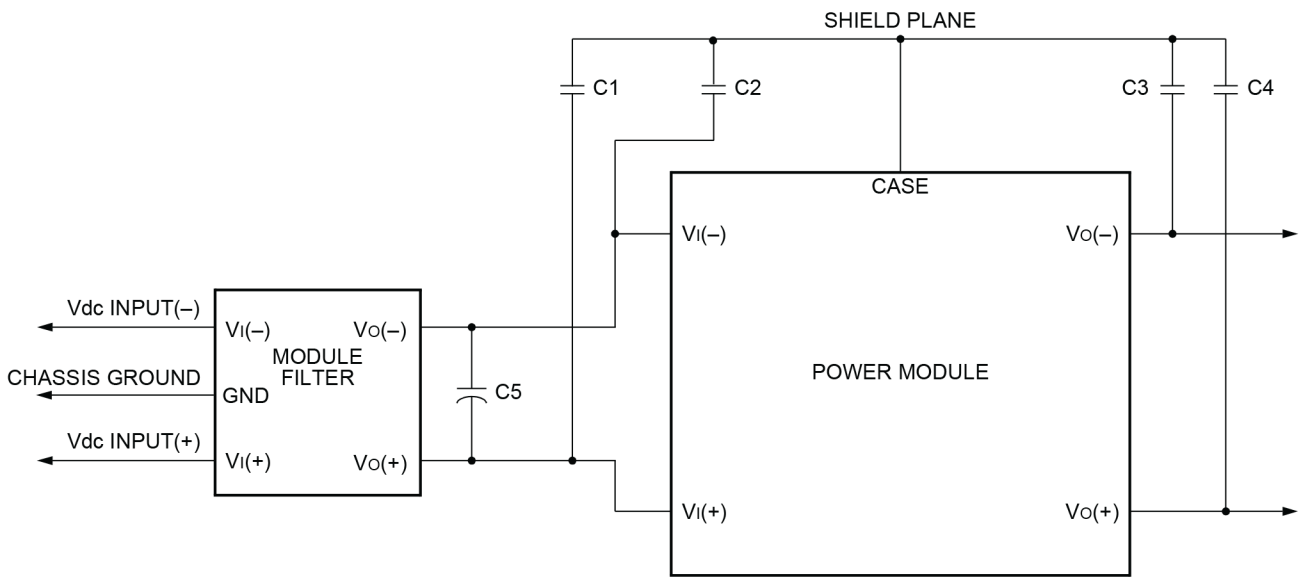

8-1325 (F).b

Note: C1 through C4 can be 0.01  $\mu$ F to 0.1  $\mu$ F. Select the voltage rating to meet input-to-output isolation requirements. C5 should be the recommended value indicated in the power module data sheet.

Figure 5. Recommended Schematic When Used as the Input Filter to a High-Frequency dc-to-dc Converter

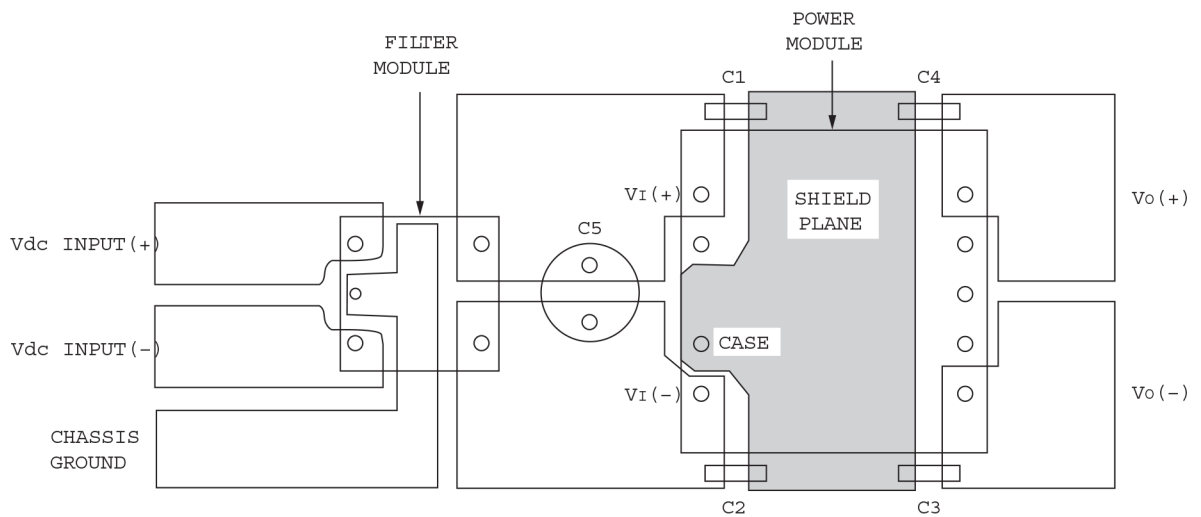

1-011:

Note: Vdc input(+) and Vdc input(-) planes should overlay each other, as should the Vi(+) and Vi(-) planes, as should the Vo(+) and Vo(-) planes. Avoid routing signals or planes under the power module or the filter module. Ensure all connections are low impedance.

Figure 6. Recommended Layout When Used as the Input Filter to a High-Frequency dc-to-dc Converter

# Application (continued)

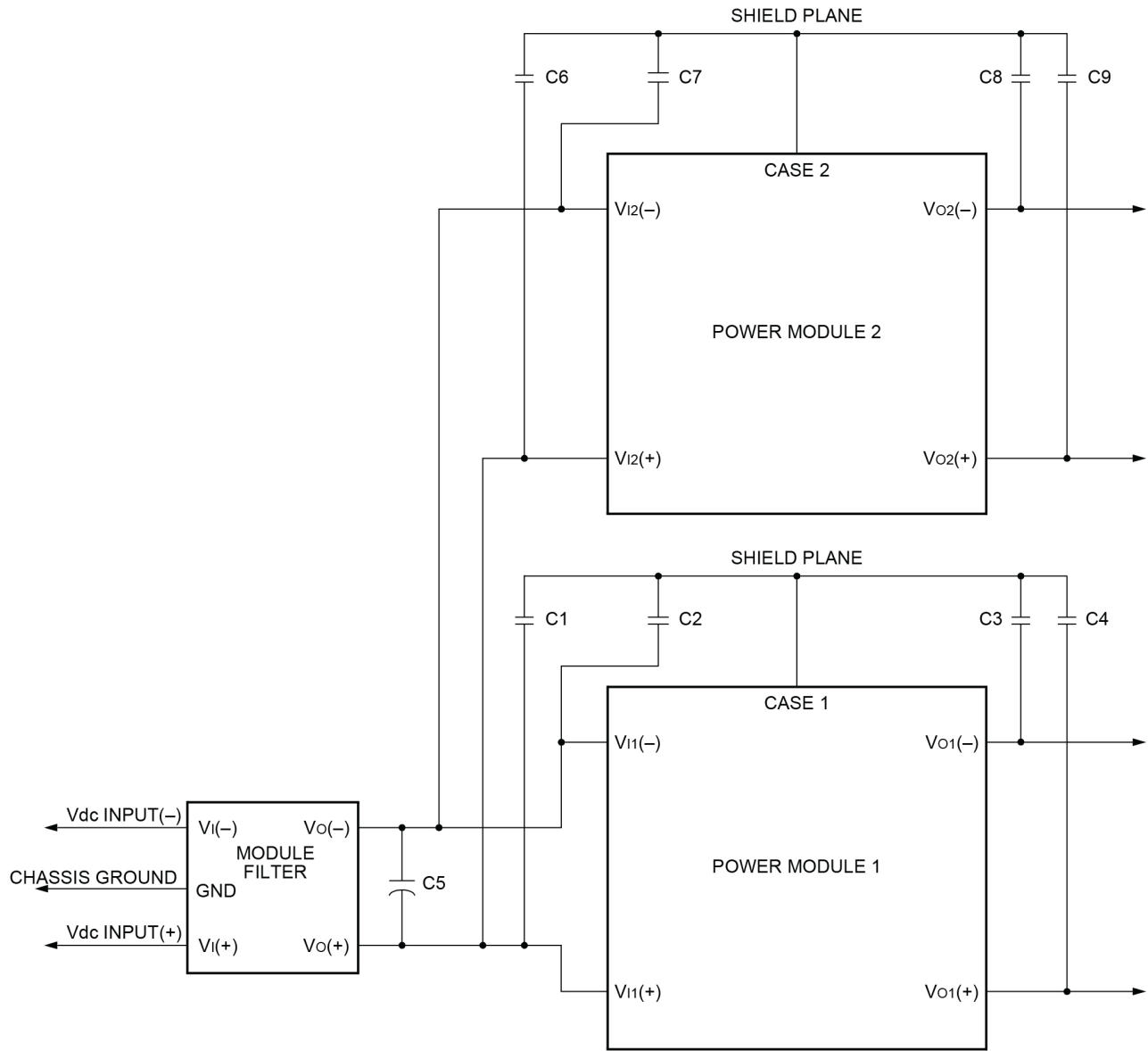

8-1362 (F).a

Note: C1 through C4 and C6 through C9 can be 0.01  $\mu$ F to 0.1  $\mu$ F. Select the voltage rating to meet input-to-output isolation requirements. C5 should be the recommended value indicated in the power module data sheet.

Figure 7. Recommended Schematic of Filter Module with Two Power Modules

## Application (continued)

Figures 9, 10 & 11 show some experimental results for various Lineage Power modules obtained by using the filter module, together with the recommended external components shown in Figures 5 and 6. Measured noise is highly dependent on layout, grounding, cable orientation, and load characteristics and will, vary from application to application.

## Thermal Considerations

The case temperature must be kept below 100 °C. The case temperature (TC) should be measured at the position indicated in Figure 8. Therefore, for a particular current and ambient temperature, the airflow at the filter must be adequate.

### Example:

Given: IO, max = 4 A; TA, max = 95 °C

Therefore  $\Delta T$ , max allowable = 5 °C

Determine airflow required (Figure 1):  $v = 2.0 \text{ m/s}$  (400lfm)

## Other Considerations

It is essential for good EMI performance that the input lines not be contaminated with noise after passing through the filter. Filtered input traces should therefore be kept away from noise sources such as power modules and switching logic lines. If input voltage sense traces must be routed past the power modules from the quiet side of the filter module, they should be filtered at the point where they leave the quiet input lines. Input traces should be kept as far away from output power traces as possible.

The fundamental switching frequency noise spike can be somewhat reduced by adding a high-frequency capacitor of a few microfarads across the input lines of the filter module.

Adding additional components to the input filter to improve performance usually has very limited payback,

and may actually increase the noise conducted onto the input lines. Adding Y caps to the input side of the filter module couples any noise in the ground plane directly into the input lines, usually degrading performance. Adding additional X and Y caps to the power module side of the filter module produces low impedance loops for high-frequency currents to flow, possibly degrading performance.

Adding additional common-mode or differential-mode filtering to the power module output leads decreases the power module output noise, and also frequently reduces the input noise by decreasing the noise coupled from output leads to input leads. Common-mode output filtering is particularly important if the load is tied to chassis ground. If common-mode filtering is added to the power

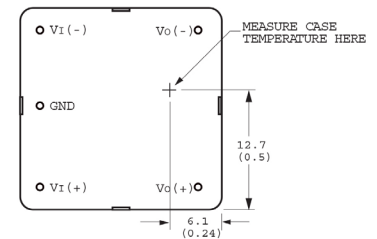

Note: Top view, pin locations are for reference only. Measurements are shown in millimeters and (inches). 1-0146

Figure 8. Case Temperature Measurement Location

module output, ensure that remote-sense leads sense the output voltage before the common mode filter. Do not use remote-sense on the load side of an output common-mode filter.

If input noise performance is unsatisfactory after applying the filter module as described previously, the best remedy is to modify the layout and grounding scheme. It is often useful to make a model of the power card, using copper tape and a vector card, to experiment with various layout and grounding approaches prior to committing to a printed-wiring board.

## Other Considerations (continued)

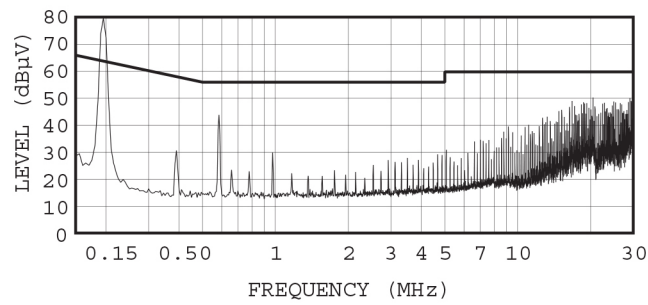

1-0321

Figure 9. HW050FG Conducted Noise with Filter Compared to Class B Limits

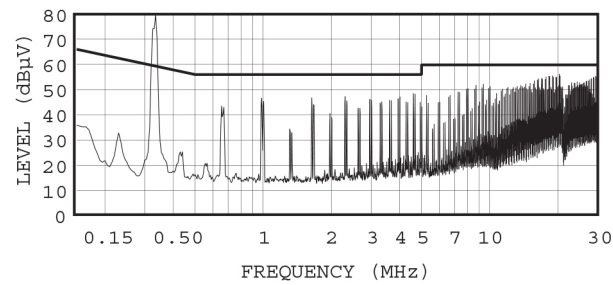

1-0322

Figure 10. JAW075A1 Conducted Noise with Filter Compared to Class B Limits

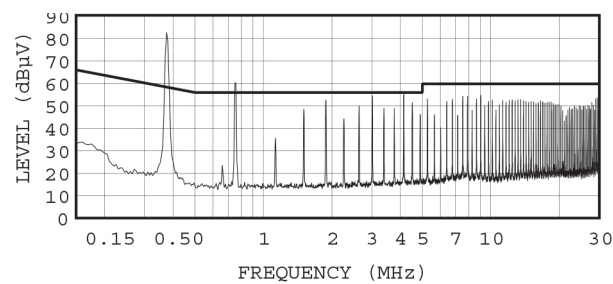

1-0323

Figure 11. QHW100F1 Conducted Noise with Filter Compared to Class B Limits



# Outline Diagram

Dimensions are in millimeters and (inches).

Tolerances:  $x.xx \pm 0.50$  mm (0.02 in.),  $x.xxx \pm 0.250$  mm (0.010 in.).

Top View

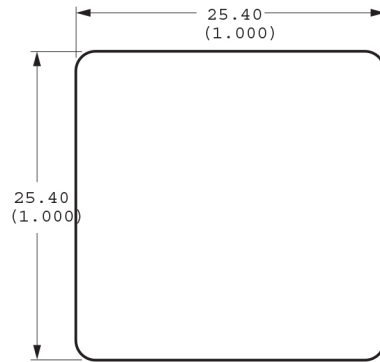

Side View

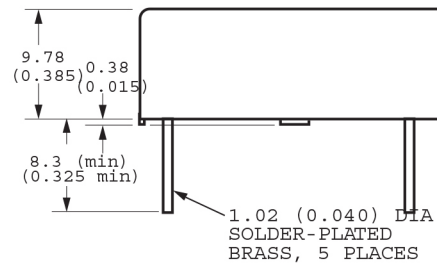

Bottom View

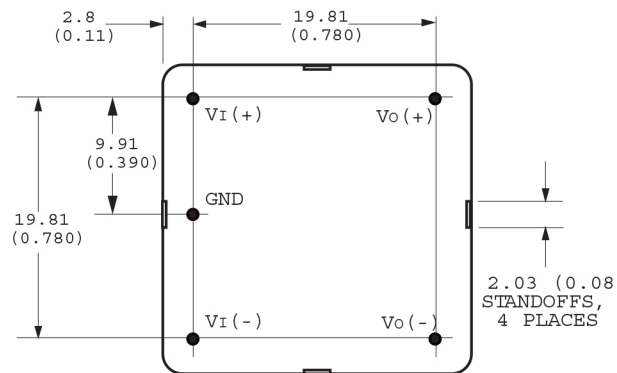

1-0119

## Recommended Hole Pattern

Component-side footprint.

Dimensions are in millimeters and (inches).

Tolerances:  $x.xx \pm 0.50$  mm (0.02 in.),  $x.xxx \pm 0.250$  mm (0.010 in.).

**Note:** Do not route copper paths beneath power module standoffs.

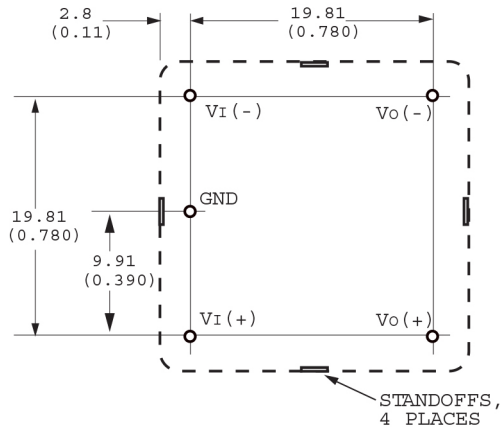

1-0119

## Post Solder Cleaning and Drying Considerations

Post solder cleaning is usually the final circuit-board assembly process prior to electrical board testing. The result of inadequate cleaning and drying can affect both the reliability of a power module and the testability of the finished circuit-board assembly. For guidance on appropriate soldering, cleaning and drying procedures, refer to Lineage Power Board Mounted Power Modules: *Soldering and Cleaning Application Note*.

## Through-Hole Lead Free Soldering Information

The RoHS-compliant through-hole products use the SAC(Sn/Ag/Cu) Pb-free solder and RoHS-compliant components. They are designed to be processed through single or dual wave soldering machines. The pins have an RoHS-compliant finish that is compatible with both Pb and Pb-free wave soldering processes. A maximum preheat rate 30C/s is suggested. The wave preheat process should be such that the temperature of the power module board is kept below 2100C. For Pb solder, the recommended pot temperature is 2600C, while the Pb-free solder pot is 2700C max. Not all RoHS-compliant through-hole products can be processed with paste-through-hole Pb or Pb-free reflow process. If additional information is needed, please consult with your Lineage Power representative for more details.

## Ordering Information

Please contact your Lineage Power Account Manager or Field Application Engineer for pricing and availability.

**Table 1. Device Codes**

DEVICE CODE	COMCODE
FLTR75V05Z	CC109102654
FLTR75V055Z	CC109128237

Optional features may be ordered using the suffixes shown in the Table below.

## Option Codes

OPTION	DEVICE CODE SUFFIX
Short pins: 4.57 mm (+0.38 mm/ -0.25 mm) (0.180 in. (+0.015 in./ -0.010 in.))	5

# Mouser Electronics

Authorized Distributor

Click to View Pricing, Inventory, Delivery & Lifecycle Information:

[ABB:](#)

[FLTR75V05Z](#) [FLTR75V055Z](#) [FLTR100V810Z](#)