



**Future Technology Devices International Ltd**

**USB-COM232-PLUS4**



## **Datasheet**

**Document Reference No.: FT\_000148**

**Version 1.2**

**Issue Date: 2010-04-12**

**Future Technology Devices International Ltd (FTDI)**

**Unit 1, 2 Seaward Place, Centurion Business Park, Glasgow, G41 1HH, United Kingdom**

**Tel.: +44 (0) 141 429 2777 Fax: + 44 (0) 141 429 2758**

**E-Mail (Support): [support1@ftdichip.com](mailto:support1@ftdichip.com) Web: <http://www.ftdichip.com>**

Neither the whole nor any part of the information contained in, or the product described in this manual, may be adapted or reproduced in any material or electronic form without the prior written consent of the copyright holder. This product and its documentation are supplied on an as-is basis and no warranty as to their suitability for any particular purpose is either made or implied. Future Technology Devices International Ltd will not accept any claim for damages howsoever arising as a result of use or failure of this product. Your statutory rights are not affected. This product or any variant of it is not intended for use in any medical appliance, device or system in which the failure of the product might reasonably be expected to result in personal injury. This document provides preliminary information that may be subject to change without notice. No freedom to use patents or other intellectual property rights is implied by the publication of this document. Future Technology Devices International Ltd, Unit1, 2 Seaward Place, Centurion Business Park, Glasgow, G41 1HH, United Kingdom. Scotland Registered Number: SC136640

## 1 Introduction

### 1.1 Functional Description

The USB-COM-Plus modules are a family of communication devices. This model, USB-COM232-PLUS4, provides a simple method of adapting four legacy RS232 serial devices to a modern USB port. This is accomplished by incorporating the industry standard FTDI FT4232H USB2.0 Hi-Speed serial bridge chip. The integrated electronics of the USB-COM232-PLUS4 utilise the FTDI FT4232H plus four RS232 level shifters and TXD/RXD LEDs to provide a visual indication of data traffic through the module.

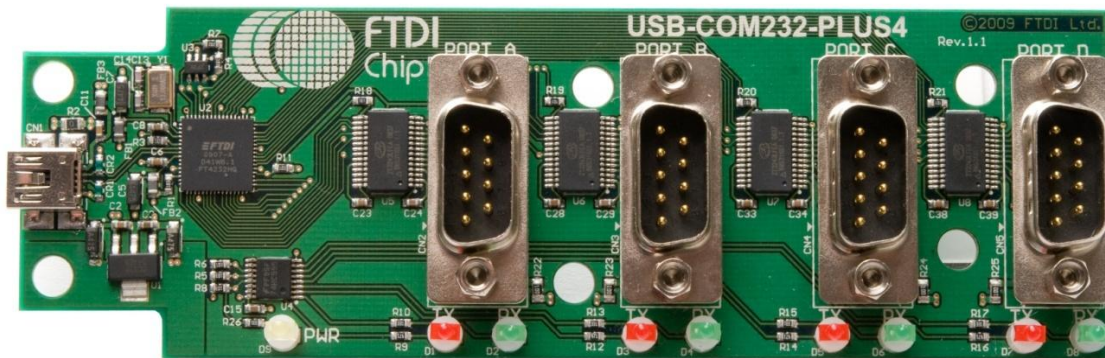

**Figure 1.1 USB-COM232-PLUS4**

The module uses a standard USB-MINIB device connector for connection to an upstream host or hub port. RS232-level signals, including modem handshake signals, are available on an industry-standard DE-9P connector. The maximum RS232-level data rate is 1Mbps.

The USB-COM232-PLUS4 module requires USB device drivers, available free from [www.ftdichip.com](http://www.ftdichip.com), which are used to make the USB-COM232-PLUS4 appear as four Virtual COM Ports (VCP). This allows existing serial communications software, such as HyperTerminal, to exchange data through the USB-COM232-PLUS4 to a legacy RS232 peripheral device.

### 1.2 LED Description

The USB-COM232-PLUS4 uses nine LEDs to indicate a valid link as well as data traffic according to the following table:

LED Colour	Function	Description	quantity
Yellow	Enumerated	ON when USB-COM-Plus is configured and ready	1
Green	TxD Activity	Flashes when data is transmitted from the USB-COM232-PLUS4 to the attached RS232 device	4
Red	RxD Activity	Flashes when data is transmitted from the attached RS232 device to the USB-COM232-PLUS4	4

**Table 1.1 – LED Description**

### 1.3 Block Diagram

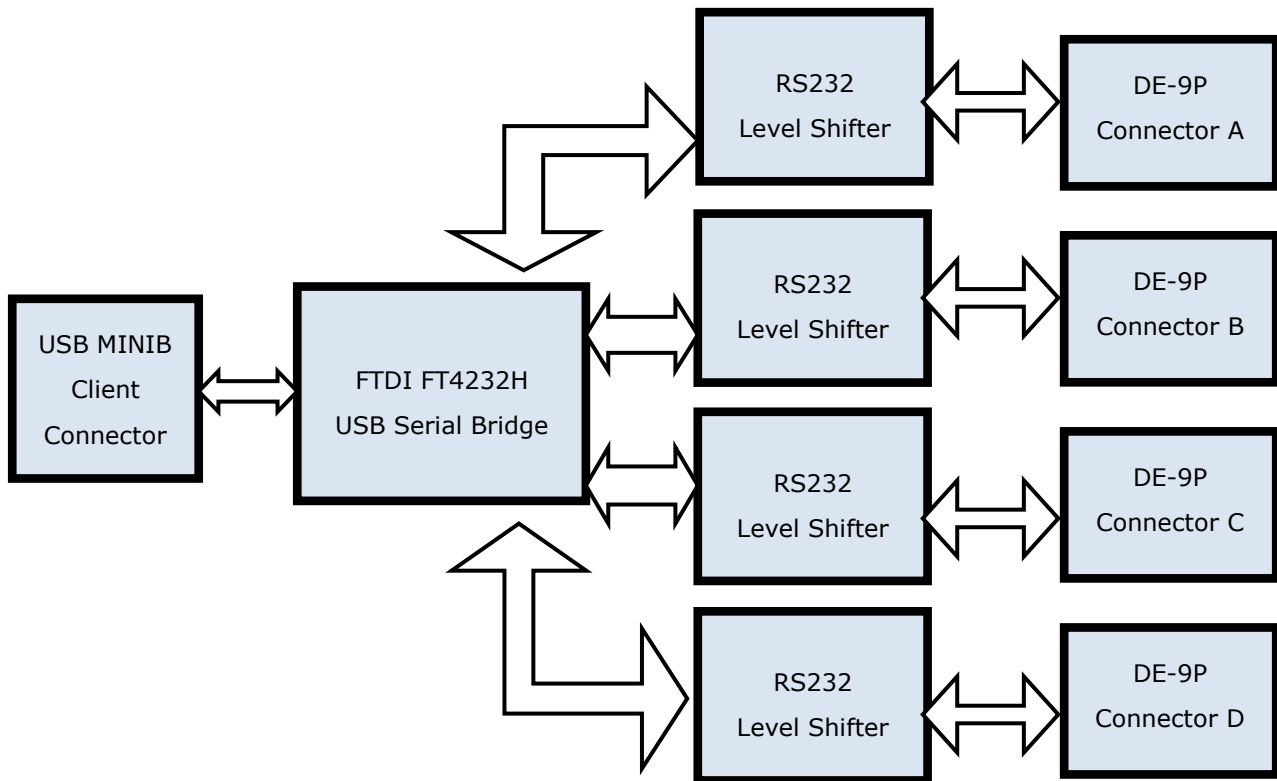

**Figure 1.2 USB-COM232-PLUS4 Block Diagram**

### 1.3.1 Block description

#### **USB MINI B Client Connector**

This connector provides the interface for connection to a USB Host or Hub port. The maximum cable length is 5 meters, according to the USB 2.0 specification.

#### **FTDI FT4232H**

The FTDI FT4232H provides the Hi-Speed USB-to-Serial conversion. Operating system device drivers are required in order to work with the FT4232H to provide the quad Virtual COM Port serial interfaces.

#### **RS232 Level Shifter**

The RS232 level shifter converts the signals provided by the FT4232H into the voltage levels required by RS232 devices.

#### **DE-9P Connector (Male)**

The DE-9P connector is configured in an industry standard (TIA/EIA-574) pin-out to provide connection to RS232 peripherals through standard cables. See section 3.1.2

## 1.4 Features

- Adds four RS-232 serial ports by connecting to Hi-Speed USB 2.0 interface.
- Easy plug & play installation and RS-232 device connection
- Provide USB2.0 Hi-Speed(480Mbps) interface and works with USB 1.1 & 2.0 Host and Hub ports
- Industry Standard FTDI chip set & device drivers for maximum compatibility
- Microsoft Windows® WHQL-certified, Mac OS X, Linux and Windows CE device drivers
- Installs as four standard Windows COM ports
- COM port number can be changed to any available COM port number, including COM1 to COM4, to support HyperTerminal, or any other serial communications software application running in Windows
- Supports Windows Server 2008, 2003, Vista, XP 2000, Linux, Mac OS X
- FIFO: 2K byte transmit buffer, 2K byte receive buffer
- RS-232 data signals: TxD, RxD, RTS, CTS, DTR, DSR, DCD, RI, GND
- Powered by USB port. No external power adapter required.
- Serial port speed up to 1Mbps
- Serial Communication Parameters
  - Parity: None, Even, Odd
  - Data bits: 7, 8
  - Flow control: RTS/CTS , DTR/DSR, X-ON/X-OFF, None
- Four DE-9P male connectors
- LEDs indicate USB Enumeration, RxD, TxD for monitoring port status & easy diagnostics
- Operating temperature of -40°C to +85°C

## 1.5 Performance Figures

Parameter	Performance
USB Interface	480Mbps USB 2.0 Hi-Speed
RS232 Interface	Standard Windows baud rates (300bps to 921.6Kbps) Custom baud rates (300bps to 1Mbps) through baud rate aliasing. See FTDI Application Note: AN232B-05 <a href="#">Configuring FT232R, FT2232 and FT232BM Baud Rates</a>

**Table 1.2 - Performance Figures**

Part Number	Description
USB-COM232-PLUS4	Hi-Speed USB to 4-Port RS232 module

**Table 1.3 - Ordering Information**

<b>1</b>	<b>Introduction .....</b>	<b>1</b>
1.1	<b>Functional Description .....</b>	<b>1</b>
1.2	<b>LED Description .....</b>	<b>1</b>
1.3	<b>Block Diagram .....</b>	<b>1</b>
1.3.1	Block description .....	2
1.4	<b>Features .....</b>	<b>3</b>
1.5	<b>Performance Figures .....</b>	<b>3</b>
<b>2</b>	<b>Installation .....</b>	<b>6</b>
2.1	<b>Example Applications and Configurations .....</b>	<b>6</b>
2.1.1	Wiring .....	6
2.2	<b>Device Driver Installation .....</b>	<b>7</b>
2.2.1	Microsoft Windows .....	7
2.2.2	Mac OS X, Linux, Windows CE .....	10
<b>3</b>	<b>Connections .....</b>	<b>11</b>
3.1	<b>External Connectors .....</b>	<b>11</b>
3.1.1	USB .....	11
3.1.2	RS232 .....	11
<b>4</b>	<b>Electrical details .....</b>	<b>12</b>
4.1	<b>USB .....</b>	<b>12</b>
4.2	<b>RS232 .....</b>	<b>12</b>
<b>5</b>	<b>Mechanical Details .....</b>	<b>13</b>
5.1	<b>Module Mechanical Dimensions .....</b>	<b>13</b>
<b>6</b>	<b>Physical Environment Details .....</b>	<b>14</b>
6.1	<b>Storage .....</b>	<b>14</b>
6.2	<b>Operating .....</b>	<b>14</b>
<b>7</b>	<b>Environmental Approvals &amp; Declarations .....</b>	<b>15</b>
7.1	<b>EMI Compatibility .....</b>	<b>15</b>
7.2	<b>Safety .....</b>	<b>15</b>
7.3	<b>Environmental .....</b>	<b>15</b>
7.4	<b>Reliability .....</b>	<b>15</b>
7.4.1	MTTF .....	15
7.5	<b>Import / Export Information .....</b>	<b>16</b>
<b>8</b>	<b>Troubleshooting .....</b>	<b>17</b>
8.1	<b>Hardware .....</b>	<b>17</b>
8.2	<b>Device Driver .....</b>	<b>17</b>
8.3	<b>Technical Support .....</b>	<b>18</b>
<b>9</b>	<b>Contact Information .....</b>	<b>19</b>



---

<b>10 Appendix A - List of Figures and tables.....</b>	<b>21</b>
<b>Appendix B - Revision History .....</b>	<b>22</b>

## 2 Installation

### 2.1 Example Applications and Configurations

#### 2.1.1 Wiring

Insert the A-plug into an available USB Host or Hub port. Insert the miniB-plug into the miniB-receptacle on the USB-COM232-PLUS4.

RS232 cables have followed a standard 9-pin configuration on a D-sub connector since the mid 1980s. The USB-COM232-PLUS4 follows this standard as a Data Terminal Equipment (DTE) device. If the RS232 equipment being connected is a Data Communication Equipment (DCE) device, it's typical that a straight-through cable can be used.

DTE Pin Number	Signal Name	DCE Pin Number
1	DCD = Data Carrier Detect	1
2	RXD = Receive Data	2
3	TXD = Transmit Data	3
4	DTR = Data Terminal Ready	4
5	GND = RS232 signal ground	5
6	DSR = Data Set Ready	6
7	RTS = Request To Send	7
8	CTS = Clear To Send	8
9	RI – Ring Indicator	9

**Table 2.1 – RS232 DTE to DCE connection with straight-through cable**

If the USB-COM232-PLUS4 is connected to another DTE device, a serial “null-modem” cable is required. A null-modem cable handles connecting output signals to the corresponding input signals on the other end.

Table 2.3 shows a typical null-modem cable. Note that RI and DCD are not always used.

DTE Pin Number	Signal Name	DTE Pin Number
2	RXD = Receive Data	3
3	TXD = Transmit Data	2
4	DTR = Data Terminal Ready	6
5	GND = RS232 signal ground	5
6	DSR = Data Set Ready	4
7	RTS = Request To Send	8
8	CTS = Clear To Send	7

**Table 2.2 – RS232 DTE to DTE connection with null-modem cable**

Some serial devices may require certain handshake signals be connected. Refer to your device manual for cabling details.

## 2.2 Device Driver Installation

The USB-COM232-PLUS4 module drivers are available for download from:

www.ftdichip.com

### 2.2.1 Microsoft Windows

With the device drivers being Windows Hardware Quality Labs (WHQL) certified, they are also available through download directly from the Microsoft® Windows® Update service. This is the best choice when connecting the USB-COM232-PLUS4 to a computer running Windows Vista. Additional installation options are noted below:

#### **Installation Executable shown on Windows XP**

- 1) Login to your system as Administrator, or a user with Administrator rights.
- 2) Prior to connecting the USB-COM232-PLUS4 to the USB Host or Hub port, download the latest device driver version from the FTDIChip web site.
- 3) Run this executable to install the device drivers.
- 4) Connect the USB-COM232-PLUS4 to your computer. A notification will appear near the task bar indicating that new hardware has been installed and is ready for use. It is normal if this notice appears twice.

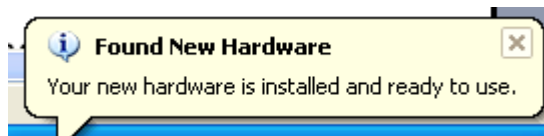

**Figure 2.1 - Hardware Ready**

#### **Windows Update shown on Windows XP**

You must have an active Internet connection and the Windows Update Service enabled.

- 1) Connect the USB-COM232-PLUS4 to your USB Host or Hub.
- 2) The "Found New Hardware" Wizard will appear. The first dialog should ask whether it is acceptable to use the Windows Update Service to find the device driver.



**Figure 2.2 – Found New Hardware Wizard**

- 3) Select one of the "Yes" choices and click "Next".
- 4) The following screen appears:



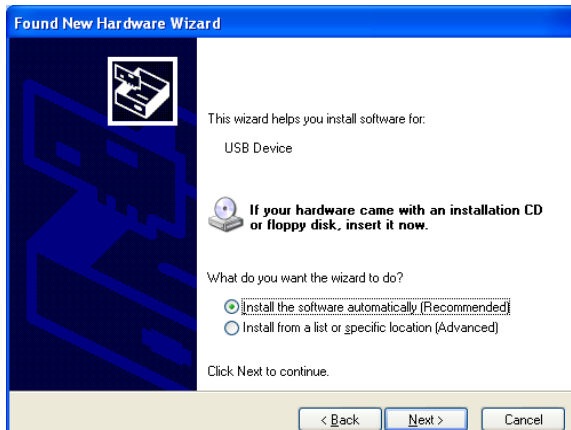

**Figure 2.3 – Automatic Install**

- 5) Wait while the driver is found, downloaded, and installed. This step may take a couple minutes depending on the Internet speed.
- 6) After the files are found and installed, click "Finish" to complete the installation.



**Figure 2.4 - Complete Hardware Installation**

- 7) Steps 2 through 6 will repeat. The first time installs the basic USB Serial Converter in the USB device tree. The second time installs the Virtual COM Port layer in the Ports tree and assigns the COM port number. You must install the Virtual COM Port layer four times, because the USB-COM232-PLUS4 has four Virtual COM Ports.
- 8) When both portions of the device driver have been installed successfully, the following message will appear, indicating that the device is ready.

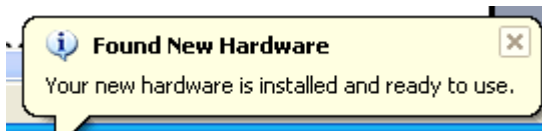

**Figure 2.5 - Hardware Ready**

### **COM Port Assignment**

Next, to determine which COM port has been assigned, open the Windows Device Manager from the System Control Panel.

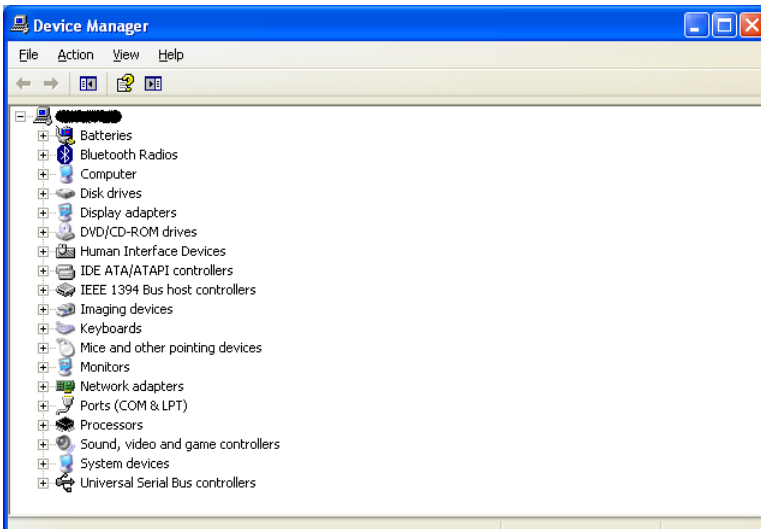

**Figure 2.6 - Device Manager**

Click on the Plus "+" sign next to the Ports tree to list the available COM port. You will see "USB Serial Port", followed by a COMn assignment. In the figure below, the USB-COM232-PLUS4 is assigned to COM1 to COM4.

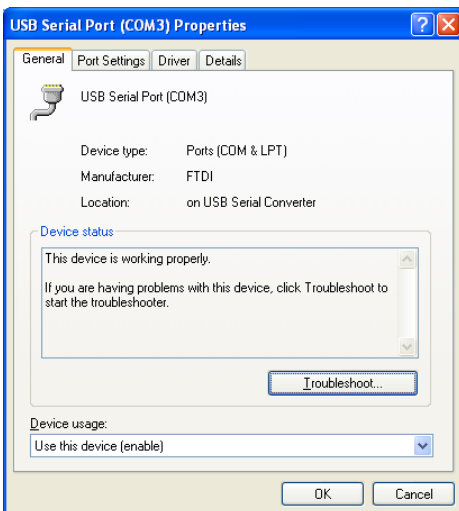

**Figure 2.7 - COM Port Assignment**

Use this COM port number with your application software in order to access the USB-COM232-PLUS4.

If an application requires use of a different COM port number, the assignment may be changed through the Advanced Driver Options settings.

From the Device Manager listing above, right-click on the USB Serial Port and select Properties.



**Figure 2.8 – Access COM Port Properties**

Next, click on the "Port Settings" tab.

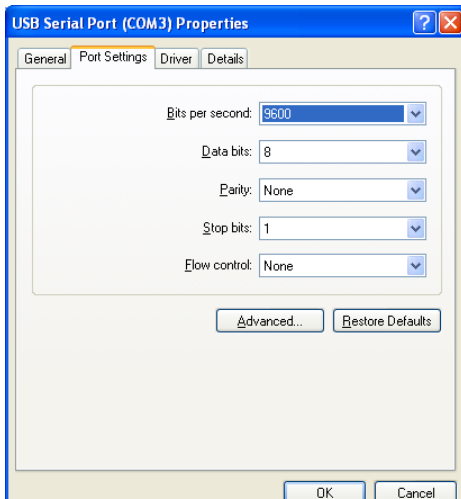

**Figure 2.9 - Settings Tab**

Then click on the “Advanced...” button.

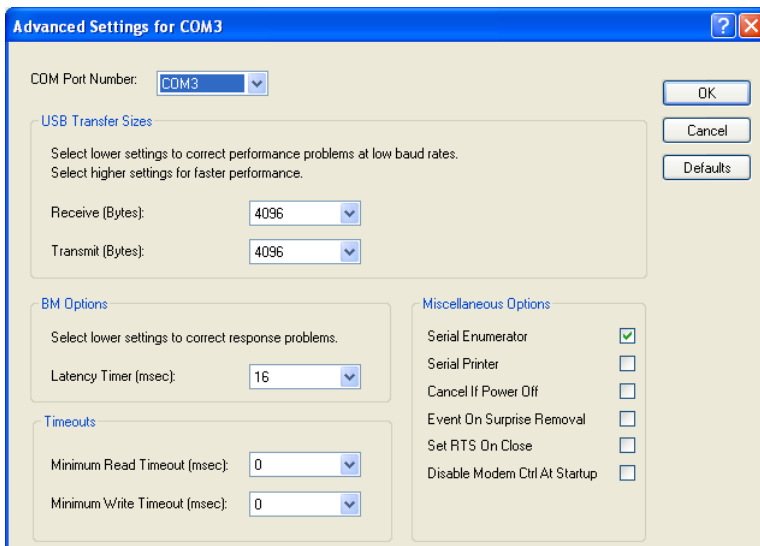

**Figure 2.10 - Advanced Options**

This will display the various advanced settings. Note the COM port assignment in the upper left. Clicking on the drop-down list will display the available port numbers. Select one that is not in use and click OK on each dialog box to activate the selection. Windows will remember this COM port number.

## 2.2.2 Mac OS X, Linux, Windows CE

Device drivers and FTDI installation guides for Mac OS X, Linux and Windows CE are available for download on the FTDIChip web sites. Follow the respective FTDI installation guides for the chosen operating system.

### 3 Connections

#### 3.1 External Connectors

##### 3.1.1 USB

The USB-COM232-PLUS4 is a downstream USB 2.0 High-speed Device. A standard USB Series "miniB" receptacle is mounted inside the USB-COM232-PLUS4 to facilitate connection to an upstream USB Host or Hub.

Pin Number	Pin Type	Description
1	Power	VBUS – USB Power provided from upstream USB Host or Hub
2	Bidirectional	D- = USB data signal, negative polarity
3	Bidirectional	D+ = USB data signal, positive polarity
4	ID	ID = Host /slave select pin ,No used
5	Ground	GND = USB signal ground
Shield	Case Ground	Drain = typically connected to the host PC case

**Table 3.1 – USB "miniB" Receptacle Pin-Out**

##### 3.1.2 RS232

The RS232 port is configured as Data Terminal Equipment (DTE), with a 9-contact D-Sub Pin connector. Pin assignments are according to TIA/EIA-574 which formally defines the assignments for a COM port found on many personal computers.

Pin Number	Pin Type	Description
1	Input	DCD = Data Carrier Detect
2	Input	RXD = Receive Data
3	Output	TXD = Transmit Data
4	Output	DTR = Data Terminal Ready
5	Ground	GND = RS232 signal ground
6	Input	DSR = Data Set Ready
7	Output	RTS = Request To Send
8	Input	CTS = Clear To Send
9	Input	RI = Ring Indicator
Shield	Case Ground	Drain = typically connected to the host PC case

**Table 3.2 – DE-9P RS232 Pin-Out**

## 4 Electrical details

### 4.1 USB

Parameter	Description	Minimum	Typical	Maximum	Units	Conditions
USB_VCC	Input Power Voltage*	4.25	5.0*	5.25	V	*Present when USB cable is attached and USB Host or Hub powered.
I <sub>cc</sub>	USB current		30	50	mA	

**Table 4.1 - USB Electrical Details**

### 4.2 RS232

Parameter	Description	Minimum	Typical	Maximum	Units	Conditions
V <sub>trans</sub>	Transmitter output voltage swing	± 5			V	RL = 3KΩ
V <sub>rec</sub>	Receiver input voltage range	±2.4		±25	V	Input resistance = 3KΩ to 7KΩ
	ESD HBM		±15		KV	RS-232 Inputs and Outputs

**Table 4.2 - RS232 Electrical Details**

## 5 Mechanical Details

### 5.1 Module Mechanical Dimensions

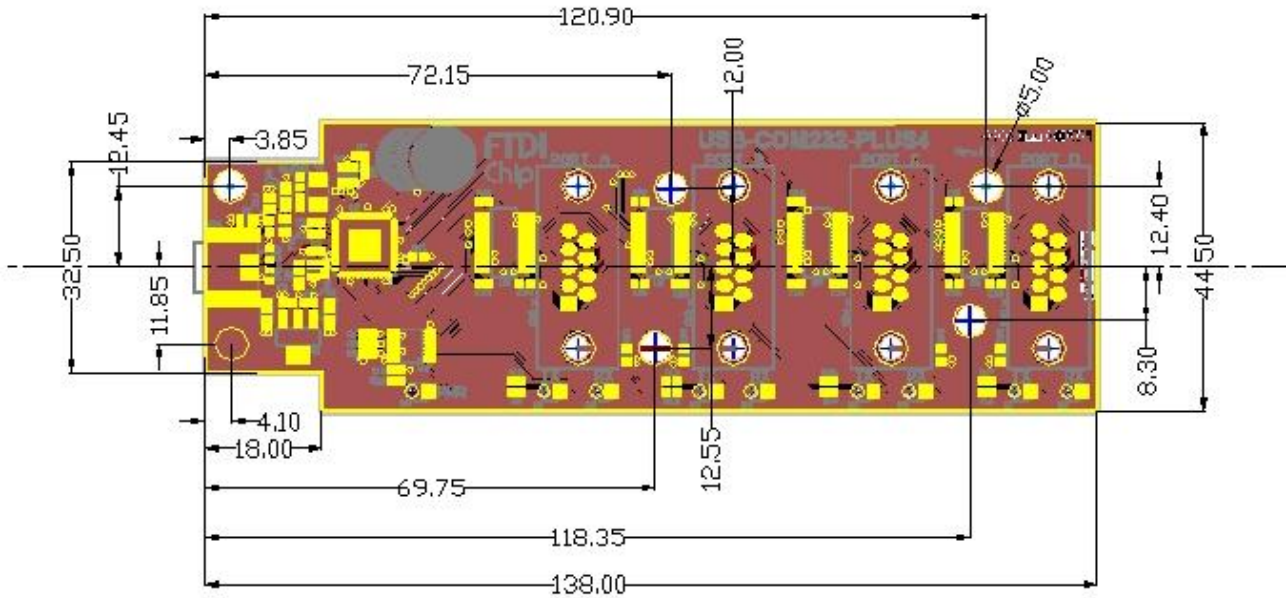

**Figure 5.1 - USB-COM232-PLUS4 PCB Dimensions**

Dimensions are in mm. The height of the module is dominated by the 4 D-type connectors and stands 12.8mm +/- 1mm. The D-type pins protrude below the PCB by 2.54mm +/- 1mm

## 6 Physical Environment Details

### 6.1 Storage

Parameter	Description	Minimum	Typical	Maximum	Units	Conditions
T	Storage Temperature Range	TBD		TBD	°C	

**Table 6.1 - Storage Temperature**

### 6.2 Operating

Parameter	Description	Minimum	Typical	Maximum	Units	Conditions
T	Operating Temperature Range	-40		+85	°C	5% to 95% RH, non condensing

**Table 6.2 - Operating Temperature**

## 7 Environmental Approvals & Declarations

### 7.1 EMI Compatibility

#### FCC and CE

The USB-COM232-PLUS4 has been tested to be compliant with both FCC Part 15 Subpart B and European EMC Directive.



NOTE: This is a Class B product. In a domestic environment, this product may cause radio interference, in which case the user may be required to take adequate measures.



NOTE: This equipment has been tested and found to comply with the limits for a Class B digital device, pursuant to Part 15 of the FCC Rules. These limits are designed to provide reasonable protection against harmful interference in a residential installation. This equipment generates uses and can radiate radio frequency energy and, if not installed and used in accordance with the instructions, may cause harmful interference to radio communications. However, there is no guarantee that interference will not occur in a particular installation. If this equipment does cause harmful interference to radio or television reception, which can be determined by turning the equipment off and on, the user is encouraged to try to correct the interference by one or more of the following measures:

- Reorient or relocate the receiving antenna.
- Increase the separation between the equipment and receiver.
- Connect the equipment into an outlet on a circuit different from that to which the receiver is connected.
- Consult the dealer or an experienced radio/TV technician for help.

### 7.2 Safety

The USB-COM232-PLUS4 is defined as Limited Power Supply (LPS) device, with operating voltages under 60VDC.

### 7.3 Environmental

The USB-COM232-PLUS4 is a lead-free device that complies with the following environmental directives: RoHS, WEEE, REACH, PFOS and DecaBDE.

### 7.4 Reliability

The USB-COM232-PLUS4 is designed as a robust USB-Serial module for use in many environments. There are no user-serviceable parts. Any failure will require a replacement of the unit.

#### 7.4.1 MTTF

The Mean Time To Failure is calculated at TBD hours.



## 7.5 Import / Export Information

Import / Export Information	
Country of Origin	China
Harmonized Code	8542.90.0000
Product Description	USB to RS232 Development Module, Four COM Port
USA ECCN	EAR99 – No License Required

**Table 7.1 - Import / Export Information**

## 8 Troubleshooting

### 8.1 Hardware

Cables are the most common sources of trouble with external devices.

Check the following:

- USB cable is properly inserted at both ends
- Computer power is ON
- Computer is not in Sleep or Standby
- If a USB Hub is used, be sure it is set for "Self-Powered" operation
- If a USB Hub is used, be sure all cables are properly inserted
- If all the above are OK, the Yellow LED should be lit, indicating the device has been recognized by the USB subsystem.

RS232 cables – check the following:

- Output signals (TXD, RTS, DTR) are connected to the respective inputs (RXD, CTS, DSR) in each direction.
- Check for specific handshake requirements of your RS232 peripheral.
- If handshake signals are not used, ensure the application is set to "No Hardware Handshake", or equivalent.
- Test the port with a loop-back connector. Connect TXD to RXD, RTS to CTS and DTR to DSR. Use a simple terminal program to check that data is transmitted and received.

### 8.2 Device Driver

Ensure the latest device driver is in use. See [www.ftdichip.com](http://www.ftdichip.com)

If other devices with FTDI chips are installed in the system, check with all manufacturers of these devices for the latest device drivers.

See the FTDI installation guides for additional details: <http://ftdichip.com/Documents/InstallGuides.htm>

Common Windows Device Driver Troubles:

- **DEVICE TIMES OUT:** The default settings of the device driver assume typical data transfers of hundreds to thousands or more bytes at a given time. Some applications, such as a GPS device, only send data in short packets, often only a few bytes. If this is the case, it may be necessary to adjust the driver buffer size and/or latency timer to smaller values. These values can be adjusted through the Advanced driver options as noted in Figure 2.13. The buffer size can be reduced to 64 bytes. The latency timer can be set as low as 2ms. A setting of 1ms will cause unnecessary USB traffic and could adversely affect data transmission.
- **ERRATIC MOUSE POINTER:** The device driver defaults to query an attached device to find out whether it is a mouse or modem, consistent with native COM port operation. Some RS232 peripherals constantly send short packets of data, causing the host system to "think" a mouse or modem has been attached. These short packets will interfere with normal mouse operation causing the pointer to jump around the screen. If this happens, disconnect the RS232 device and *uncheck the Serial Enumerator* option, also found on the Advanced driver options screen in Figure 2.13.
- **COM PORT IN USE:** Windows keeps track of all COM port assignments. If multiple FTDIChip products have been connected to a single system, the COM port number will increase, even if the other devices are not attached. If the higher COM port assignments are not acceptable for the application, known unused COM port numbers should be uninstalled according to the FTDI installation guide: <http://ftdichip.com/Documents/InstallGuides.htm>.

---

### 8.3 Technical Support

Technical support may be obtained from your nearest FTDIChip office:

United Kingdom: [\*\*support1@ftdichip.com\*\*](mailto:support1@ftdichip.com)  
United States: [\*\*us.support@ftdichip.com\*\*](mailto:us.support@ftdichip.com)  
China: [\*\*cn.support@ftdichip.com\*\*](mailto:cn.support@ftdichip.com)  
Taiwan: [\*\*tw.support1@ftdichip.com\*\*](mailto:tw.support1@ftdichip.com)

## 9 Contact Information

### Head Office – Glasgow, UK

Future Technology Devices International Limited  
Unit 1, 2 Seaward Place  
Centurion Business Park  
Glasgow, G41 1HH  
United Kingdom  
Tel: +44 (0) 141 429 2777  
Fax: +44 (0) 141 429 2758

E-mail (Sales) [sales1@ftdichip.com](mailto:sales1@ftdichip.com)  
E-mail (Support) [support1@ftdichip.com](mailto:support1@ftdichip.com)  
E-mail (General Enquiries) [admin1@ftdichip.com](mailto:admin1@ftdichip.com)  
Web Site URL <http://www.ftdichip.com>  
Web Shop URL <http://www.ftdichip.com>

### Branch Office – Shanghai, China

Future Technology Devices International Limited (China)  
Room 408, 317 Xianxia Road,  
ChangNing District,  
ShangHai, China

Tel: +86 (21) 62351596  
Fax: +86(21) 62351595

E-Mail (Sales): [cn.sales@ftdichip.com](mailto:cn.sales@ftdichip.com)  
E-Mail (Support): [cn.support@ftdichip.com](mailto:cn.support@ftdichip.com)  
E-Mail (General Enquiries): [cn.admin1@ftdichip.com](mailto:cn.admin1@ftdichip.com)  
Web Site URL: <http://www.ftdichip.com>

### Branch Office – Taipei, Taiwan

Future Technology Devices International Limited (Taiwan)  
2F, No 516, Sec. 1 NeiHu Road  
Taipei 114  
Taiwan, R.O.C.

Tel: +886 (0) 2 8791 3570  
Fax: +886 (0) 2 8791 3576

E-mail (Sales) [tw.sales1@ftdichip.com](mailto:tw.sales1@ftdichip.com)  
E-mail (Support) [tw.support1@ftdichip.com](mailto:tw.support1@ftdichip.com)  
E-mail (General Enquiries) [tw.admin1@ftdichip.com](mailto:tw.admin1@ftdichip.com)  
Web Site URL <http://www.ftdichip.com>

### Branch Office – Hillsboro, Oregon, USA

Future Technology Devices International Limited (USA)  
7235 NW Evergreen Parkway, Suite 600  
Hillsboro, OR 97123-5803  
USA

Tel: +1 (503) 547 0988  
Fax: +1 (503) 547 0987

E-Mail (Sales) [us.sales@ftdichip.com](mailto:us.sales@ftdichip.com)  
E-Mail (Support) [us.support@ftdichip.com](mailto:us.support@ftdichip.com)  
E-mail (General Enquiries) [us.admin@ftdichip.com](mailto:us.admin@ftdichip.com)

Web Site URL <http://www.ftdichip.com>



### **Distributor and Sales Representatives**

Please visit the Sales Network page of the FTDI Web site for the contact details of our distributor(s) and sales representative(s) in your country.

## 10 Appendix A - List of Figures and tables

### List of Figures:

Figure 1.1 USB-COM232-PLUS4.....	1
Figure 1.2 USB-COM232-PLUS4 Block Diagram .....	2
Figure 2.1 - Hardware Ready .....	7
Figure 2.2 – Found New Hardware Wizard .....	7
Figure 2.3 – Automatic Install.....	8
Figure 2.4 - Complete Hardware Installation .....	8
Figure 2.5 - Hardware Ready .....	8
Figure 2.6 - Device Manager .....	9
Figure 2.7 - COM Port Assignment .....	9
Figure 2.8 – Access COM Port Properties.....	9
Figure 2.9 - Settings Tab .....	10
Figure 2.10 - Advanced Options.....	10
Figure 5.1 - USB-COM232-PLUS4 PCB Dimensions .....	13

### List of tables:

Table 1.1 – LED Description .....	1
Table 1.2 - Performance Figures .....	3
Table 1.3 - Ordering Information .....	3
Table 2.1 – RS232 DTE to DCE connection with straight-through cable .....	6
Table 2.2 – RS232 DTE to DTE connection with null-modem cable .....	6
Table 3.1 – USB "miniB" Receptacle Pin-Out .....	11
Table 3.2 – DE-9P RS232 Pin-Out.....	11
Table 4.1 - USB Electrical Details.....	12
Table 4.2 - RS232 Electrical Details .....	12
Table 6.1 - Storage Temperature .....	14
Table 6.2 - Operating Temperature .....	14
Table 7.1 - Import / Export Information.....	16

---

## Appendix B - Revision History

Version Draft	First Draft	12 <sup>th</sup> June 2009
Version 1.0	First Release	July 7th 2009
Version 1.1	Corrected title page which said PLUS1 instead of PLUS4	12/08/09
Version 1.2	Edited Section 1.3.1, Removed the statement "A standard "A to B" cable is provided"	12/04/2010

# Mouser Electronics

Authorized Distributor

Click to View Pricing, Inventory, Delivery & Lifecycle Information:

[FTDI:](#)

[USB-COM232-PLUS4](#)