

TPC
High Voltage Ceramic Capacitors

	Page
Introduction	
High Voltage Ceramic Capacitors	2
General Characteristics	3
Dielectrics - Type I - Temperature Compensating.	4
Dielectrics - Paraelectric and Type II.	6
How To Order	8
High Voltage Ceramic Capacitors	
Selection Guide	10
General Characteristics	12
HZ Type - Strontium-based Dielectric.	13
HP Type - Strontium-based Dielectric.	14
HB / HF Types - Type II	15
HD / HE Types - Type II (N)	16
Custom Designed Live-Line Dividers	17
HR / HS Types - Type II	18
HT / HU Types- Type I	19
Quality Assurance	20
Manufacturing Process	21
Marking - Packaging - Identification	22
Questionnaire: How to Define a Capacitor.	23
Standard Series and Associated Tolerances	24

NOTICE: Specifications are subject to change without notice. Contact your nearest AVX Sales Office for the latest specifications. All statements, information and data given herein are believed to be accurate and reliable, but are presented without guarantee, warranty, or responsibility of any kind, expressed or implied. Statements or suggestions concerning possible use of our products are made without representation or warranty that any such use is free of patent infringement and are not recommendations to infringe any patent. The user should not assume that all safety measures are indicated or that other measures may not be required. Specifications are typical and may not apply to all applications.

Introduction

High Voltage Ceramic Capacitors

HIGH VOLTAGE CERAMIC CAPACITORS are particularly suitable for applications requiring a high voltage (from 10 to 150 kV), while reactive current remains low. Ceramic capacitors also achieve very good performance under pulse and discharge conditions.

Various disc types cover a wide range of capacitances and voltages as shown in the following figure. Specific properties depend on the dielectric material used.

Other configurations such as rods (HF type), cascades (HC type) are used to meet specific applications.

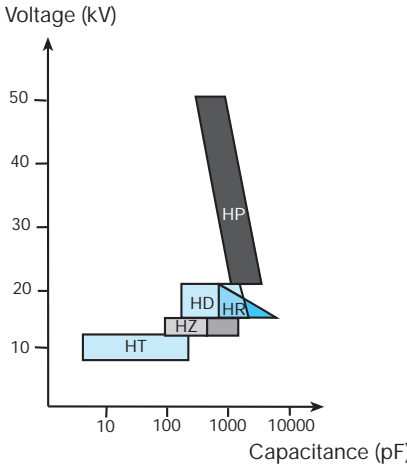

General Characteristics

The real characteristics of a capacitor can be described using conventional physical parameters and the following equivalent electrical circuit:

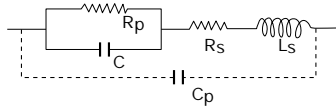

C capacitance is a measure of the capacitor's aptitude to store electrical charges Q under a voltage V ($C = Q/V$).

K the dielectric constant, specific to each material (less than 500 for type I materials, from 1000 up to 10,000 for type II materials),

A the area of the electrodes, and
t the thickness of the dielectric layer are the parameters determining the capacitor value

$$C = K \frac{A}{t} \quad (K = \epsilon_r)$$

T.C. the temperature coefficient of the capacitance is expressed in ppm/°C for stable type I dielectrics.

ΔC/C is used for type II dielectrics and is expressed in % of change of the capacitance in a fixed temperature range.

V_R the rated voltage is the maximum voltage that can be applied to the capacitor on continuous operation. It can be constituted by:

V_{DC} a direct current component

V_{RMS} an alternating current component

V_P the peak voltage

V_E the test voltage

R_P the parallel resistance

IR the insulation resistance under V_{DC} .

R_S or ESR (Equivalent Series Resistance) accounts for the conductivity of the electrodes and connections.

L_S or ESL (Equivalent Series Inductance) depends on the geometry of electrodes dielectric and connections, leads...

C_P takes into account dielectric environment of the capacitor (coating...) but is generally neglected except to describe very high frequency behavior of the capacitor or for very low capacitance value.

R_p , R_s , L_s , C_p can be considered as parasitic effects. They generate energy losses and a dephasing

φ difference between voltage and current from 90°. The loss angle δ ($90^\circ - \varphi$) is commonly used.

tg δ the tangent of loss angle

DF the dissipation factor (same as tg δ)

Q the quality factor is the ratio between the stored energy and the dissipated energy. It measures the quality of the capacitor and can be expressed as $Q = 1/\text{tg } \delta$ or $1/D.F.$

f being the frequency of the AC signal

ω the pulsation of this signal with $\omega = 2\pi f$

Z the complex impedance of the capacitor is given by the relation (neglecting C_p):

$$Z = R_S + j L_S \omega + \frac{1}{\frac{1}{R_P} + j C \omega} = R + j X$$

the tangent of the loss angle $\text{tg } \delta$ can also be expressed as $\text{tg } \delta = \frac{R}{X}$

$$\text{tg } \delta = \frac{R}{X}$$

so, neglecting L_s for $L_S \omega < \frac{1}{C \omega}$

$$\text{tg } \delta = R_S C \omega + \frac{1}{R_P C \omega} + \frac{1}{R_P^2 C \omega}$$

f_{RS} the series resonance frequency of the capacitor is the frequency where the capacitance reactance is exactly equal to the inductive reactance due to L_s

$$L_S \omega = \frac{1}{C \omega} \text{ or } \omega = \frac{1}{\sqrt{L_S C}} \text{ or } f_{RS} = \frac{1}{2\pi \sqrt{L_S C}}$$

f_{RP} the parallel resonance frequency occurs when L_s is equal to C_p :

$$f_{RP} = \frac{1}{2\pi \sqrt{L_S C_P}}$$

Between f_{RS} and f_{RP} , the capacitor reacts as an inductance, but still blocks DC.

The equivalent electrical circuit can be simplified using approximations according to the frequency:

- At $f = f_{RS}$ the circuit is reduced to



- For high frequencies but below f_{RS}



- For low frequencies $Z = \frac{1}{\frac{1}{R_P} + jC\omega}$

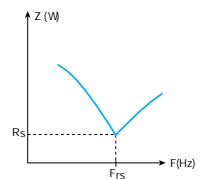
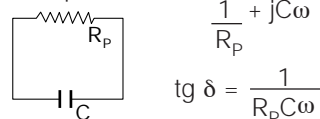

I_{RMS} is the maximum RMS current that can be transmitted by the capacitor electrodes

W_R is defined as the maximum reactive power and is expressed by $W_R = V_{RMS}^2 C \omega = \frac{I_{RMS}^2}{C \omega}$

W_A is the active power or dissipated power $W_A = W_R \text{tg } \delta = (2\pi f C V^2)(DF)$

Dielectrics - Type I - Temperature Compensating

TYPE I CAPACITORS - GENERAL

(with specific temperature coefficient)

Type I capacitors are particularly suitable for applications where high stability of capacitance and low losses are required (tuning circuit capacitors). In addition, they offer linear capacitance change with temperature.

DIELECTRIC SELECTION - STANDARDIZATION

Temp. coeff.* ($\Delta\theta = -55 \text{ } +125^{\circ}\text{C}$)		Specification Code			
Value (ppm/ $^{\circ}\text{C}$)	Tolerance** (ppm/ $^{\circ}\text{C}$)	TPC	CECC CEI MIL	DIN	EIA
(P100)	+100 \pm 30	A	AG / 1B	P100/1B	M7G
(NP0)	0 \pm 30	C	CG / 1B	NP0/1B	C0G
(N33)	-33 \pm 30	H	HG / 1B	N33/1B	H2G
(N150)	-150 \pm 30	P	PG / 1B	N150/1B	P2G
(N470)	-470 \pm 120	T	TJ / 1B	N470/1B	T2J
(N750)	-750 \pm 120	U	UJ / 1B	N750/1B	U2J
(N1500)	-1500 \pm 250	V	VK / 1B	N1500/1B	V2K

* Reference temperature (CECC): 25 $^{\circ}\text{C}$

** If not otherwise specified in data sheets

DIELECTRIC CHARACTERISTICS (typical values - non-exhaustive list)

TPC code	A	C	H	P	T	U	V
Dielectric class	P100	NP0	N33	N150	N470	N750	N1500
Temperature coefficient of the capacitance (ppm/ $^{\circ}\text{C}$)	+100	0	-33	-150	-470	-750	-1500
Operating temperature range ($^{\circ}\text{C}$)	-25 +95	-25 +95	-25 +95	-25 +95	-25 +95	-25 +95	-25 +95
Typical dielectric constant	15	18	30	70	50	125	270
Dielectric strength kV _{DC} /mm	20	20	20	8	8	8	6
Dissipation factor (1MHz/25 $^{\circ}\text{C}$)	5.10 ⁻⁴	5.10 ⁻⁴	5.10 ⁻⁴	5.10 ⁻⁴	5.10 ⁻⁴	10.10 ⁻⁴	10.10 ⁻⁴
Insulation resistance (500V/25 $^{\circ}\text{C}$)	> 100 G	> 100 G	> 100 G	> 100 G	> 100 G	> 100 G	> 100 G

Dielectrics - Type I - Temperature Compensating

TYPICAL CHANGE OF CAPACITANCE WITH TEMPERATURE

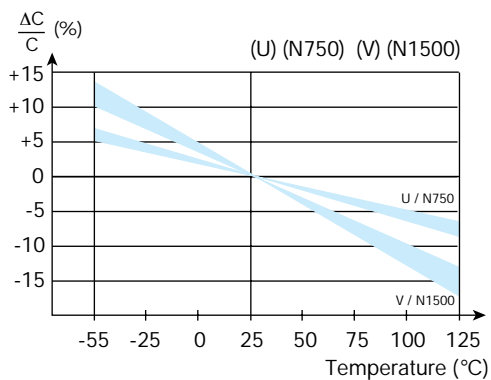
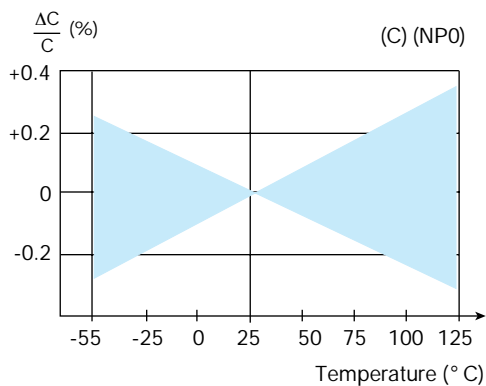
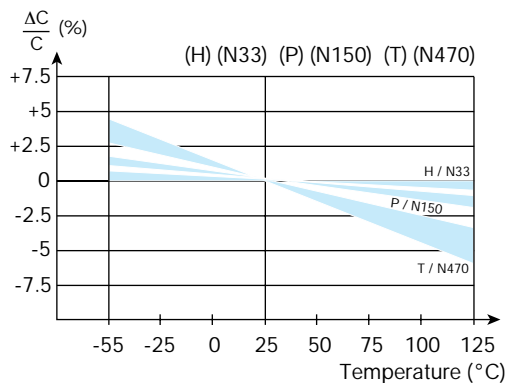
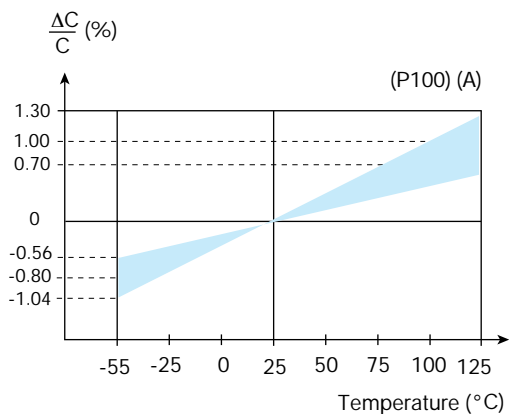

PARAMETER CHANGE WITH TEMPERATURE, VOLTAGE AND FREQUENCY

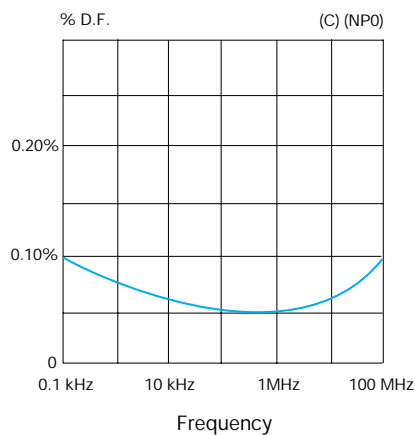
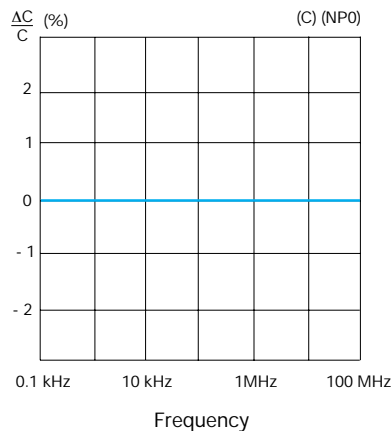
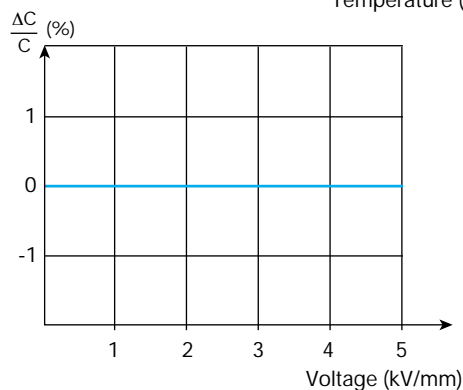
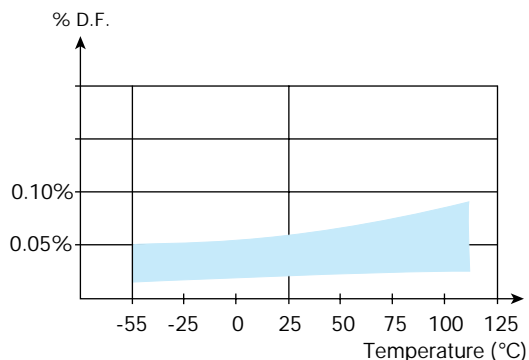

PARAELECTRIC DIELECTRICS - GENERAL

These strontium-based dielectrics exhibit a high dielectric constant (>1500) and excellent electrical properties including high dielectric strength, low dissipation factor and low capacitance change with applied voltage.

They are particularly suitable for high energy discharge applications as they present no electrostriction or piezoelectric phenomenon.

TYPE II DIELECTRICS - GENERAL

(with non-specific temperature coefficient)

Type II dielectrics are characterized by a high permittivity (higher than 1000), giving large capacitance with small size.

They are particularly suitable for filtering, decoupling and any applications for which capacitance changes and dielectric losses are of lesser importance.

They also present a drift effect of the capacitance as shown below due to natural aging of the ceramic dielectric.

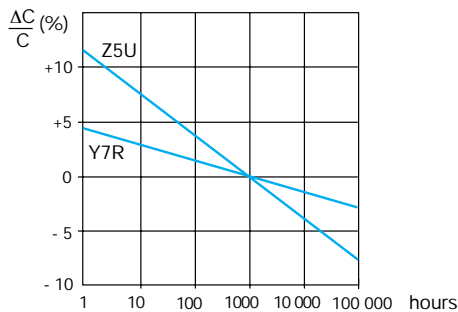

DIELECTRIC SELECTION - STANDARDIZATION

Temperature		Classes			
$\frac{\Delta C}{C}$		TPC	CEI CECC	EIA	DIN
Paraelectric dielectrics					
$\frac{\Delta C}{C}$	Temperature				
+22 -33%	-30 +85°C	E		(Y5T)	N4700
+300 -82%	-30 +85°C	N			
Type II					
±10%	-55 +125°C	1	(2B1)	X7P	
±15%	-30 +125°C	Z	(2R4)	Y7R	
±22%	-30 +85°C	3	(2C4)	Y5S	
+22 -33%	-30 +85°C	4	(2E4)	Y5T	
+22 -82%	-30 +85°C	X	(2F4)	Y5V	
+22 -56%	+10 +85°C	W	(2E6)	Z5U	

Note: classes with () = approximate classes

DIELECTRIC CHARACTERISTICS (typical values - non-exhaustive list)

TPC code	E*	N*	1	Z	3	4	X	W
Dielectric class	N4700	See curves on page 7	X7P	Y7R	Y5S	Y5T	Y5V	Z5U
Operating temperature range (°C)	-30 +85	-30 +85	-55 +125	-30 +125	-30 +85	-30 +85	-30 +85	+10 +85
Capacitance change with temperature (%)	+22 -33	(+300 -82)	±10	±15	±22	+22 -33	+22 -82	+22 -56
Typical dielectric constant at 0.25 kV/mm	1850	2000	1000	2600	3300	3500	6500	7000
Dielectric strength kV _{DC} /mm	8.0	7.0	6.0	5.5	5.5	5.5	4.0	5.0
Dissipation factor (1 kHz/1 V _{rms} /20°C)	5.10 ⁻⁴	20.10 ⁻⁴	100.10 ⁻⁴	200.10 ⁻⁴	100.10 ⁻⁴	150.10 ⁻⁴	200.10 ⁻⁴	100.10 ⁻⁴
Insulation resistance (500V/20°C)	> 10 G	> 10 G	> 10 G	> 10 G	> 10 G	> 10 G	> 10 G	> 10 G

TYPICAL CHANGE OF CAPACITANCE WITH TEMPERATURE

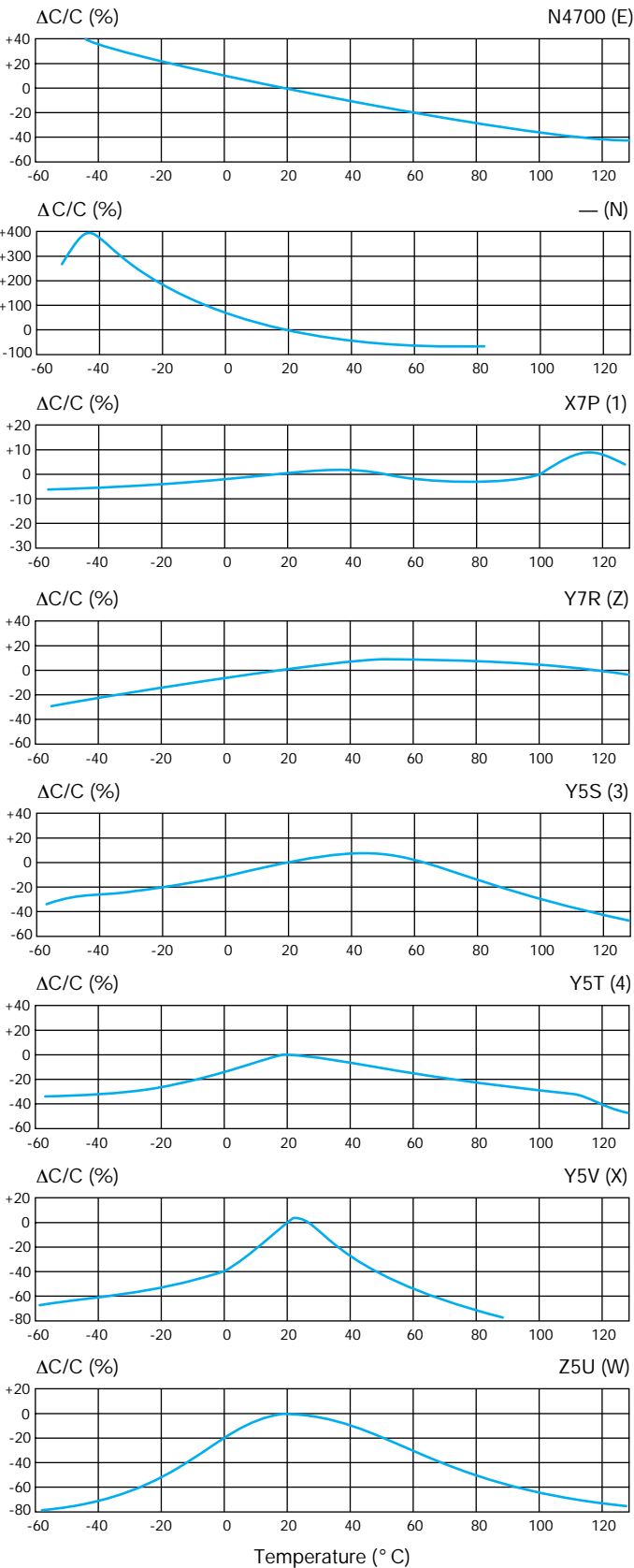

TYPICAL CHANGE OF CAPACITANCE WITH APPLIED D.C. VOLTAGE

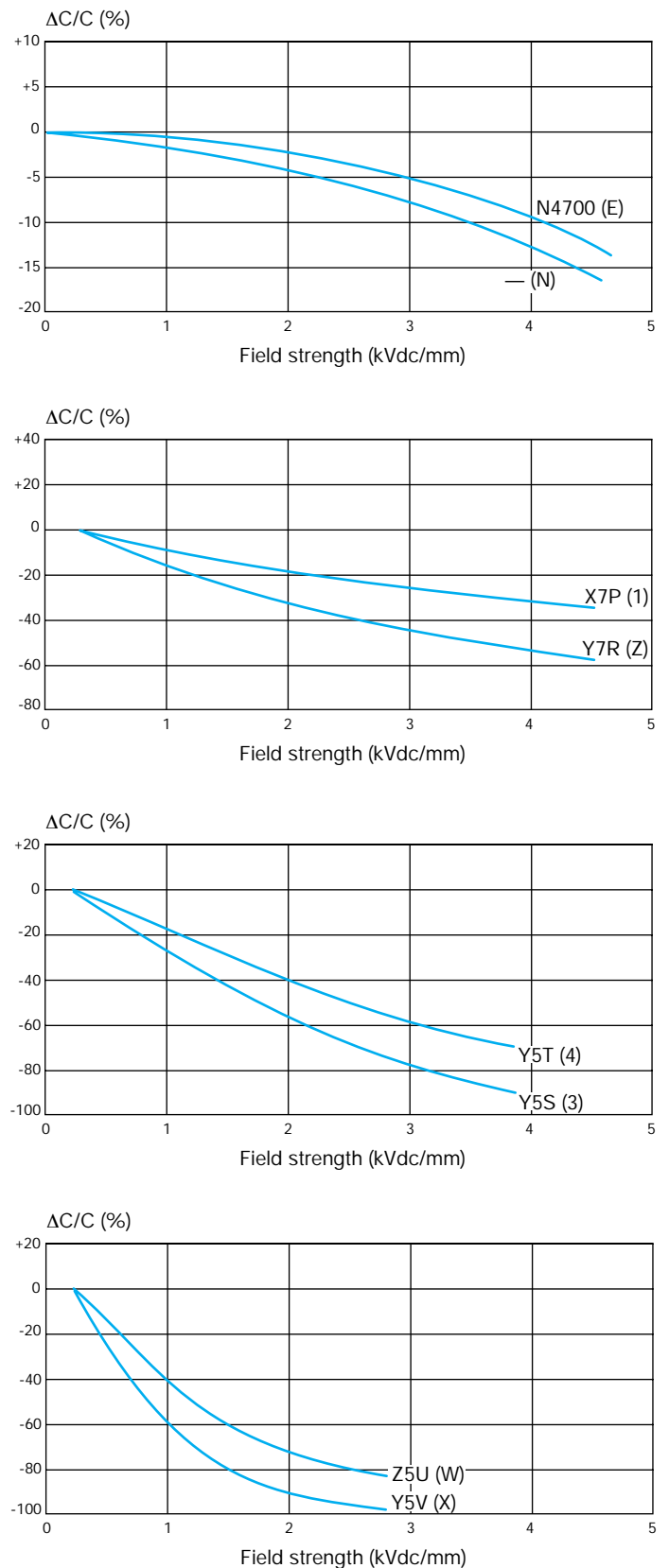

High Voltage Ceramic Capacitors



How To Order

ORDERING CODE

HP40	E	3	0102	M	--
Type/Size High Voltage Radial-led Discs 09 12 HZ 16 20 22 Coated Discs HT 30 HD 40 HR 60 30 HP 40 50 60 Uncoated Discs HU 30 HE 40 HS 60 Rods HB 30 HF 40 60	Class Type I A = P 100 C = NP0 H = N33 T = N470 U = N750 V = N1500 Type II E = N4700 N = N10000 W = +22 -56% X = +22 -82%	Voltage 1000 V: L 1600 V: M 2000 V: N 2500 V: P 3000 V: Q 4000 V: R 5000 V: S 6000/6300 V: T 8000/9000 V: U 10,000 V: V 12,500 V: W 15/16 kV: X 20/25 kV: Y 30 kV: 3 40 kV: 4 50 kV: 5 For the following types whose class or voltage is not specified but inferred by the type, the size and the value: write 0 (zero) in the 5th (class) or 6th digit case (voltage).	Capacitance (EIA code) Capacitance expressed by 2 significant figures 1st digit: 0 (zero) 2nd and 3rd digits: the 2 significant figures of the capacitance value. 4th digit: - for values $\geq 10\text{pF}$ and $\leq 990\mu\text{F}$: the number of ZEROS to be added to the capacitance values - for values $\geq 1\text{pF}$ and $\leq 9.9\text{pF}$: the figure 9 signifying that the capacitance value is to be multiplied by 0.1 Examples: 1000pF: 0102 8.2pF: 0829 Capacitance expressed by 3 significant figures 1st, 2nd and 3rd digits: the 3 significant figures of the capacitance value. 4th digit: - for values $> 100\text{pF}$ and $\leq 999\mu\text{F}$: the number of ZEROS to be added to the capacitance value - for values $> 10\text{pF}$ and $< 100\text{pF}$: the figure 9 signifying that the capacitance value is to be multiplied by 0.01. - for values $> 1\text{pF}$ and $\leq 10\text{pF}$: the figure 8 signifying that the capacitance value is to be multiplied by 0.01. Examples: 196pF: 1960 47.2pF: 4729 8.28pF: 8288	Tolerance C < 10pF $\pm 1\text{pF}$ $\pm 2\text{pF}$ C $\geq 10\text{pF}$ $\pm 5\%$ $\pm 10\%$ $\pm 20\%$ -20 +50% -20 +80%	Suffix -- PY WH Code Code J K M S Z
	Class not specified HD HE HR HS HB HF	Voltage not specified HT HU HB HF			

NOTE: Special drawing number

If customer requirements differ from the standard type, the codification of the product is modified as follows:

5th, 6th digit: -

7th digit: H for high voltage types

8th, 9th, 10th digit: drawing number

11th digit: -







12th, 13th digit: two digits number for revised edition number

HIGH VOLTAGE CERAMIC CAPACITORS

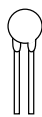
High Voltage Ceramic Capacitors

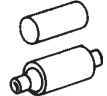

Selection Guide

Main Signal Component	Applications	Series	Type / Size / Finish
PULSES	Medium energy pulses	Radial leaded discs	HZ 09 12 16 18 20 22 26 
	High energy pulses	Molded discs with connections	HP 30 40 50 60 
AC	Live - line indication	Rods	HB HF 30 40 60 
	AC voltage dividers at line frequency	Molded discs with connectors	HD (HE) 30 40 60 
	Voltage dividers	Custom products	Complete dividers
DC	High voltage decoupling	Molded discs	HR (HS) 30 40 60 
	Low reactive power coupling or tuning	with connections	HT (HU) 30 40 60 

High Voltage Ceramic Capacitors



Selection Guide

Dimensions millimeters (inches)			Dielectric Class	Reference	Capacitance CR (pF)	Electrical Characteristics			Detailed specification on page
Diam.	Thick.	Height				Peak Rated Voltage (V _R) (kV)	Test Voltage V _E (kV)	Max. tg δ (DF)	
9.5 (0.374) 12 (0.472) 16 (0.630) 18 (0.709) 20 (0.787) 22 (0.866) 26 (1.024)	9 (0.354) 9 (0.354) 9 (0.354) 9 (0.354) 9 (0.354) 10 (0.394) 11 (0.433)	14.5 (0.571) 16 (0.630) 20 (0.787) 22 (0.866) 24 (0.945) 26 (1.024) 30 (1.180)	N4700	HZ .. EW .. M --	100 2700	6, 9, 12	9, 14, 18	10.10 ⁻⁴	13
28 (1.100) 38 (1.500) 48 (1.900) 58 (2.283)	23 (0.906) ... 32 (1.260)	17 (0.669) ... 26 (1.024)	N4700	Y HP .. E3 M-- 4	390 4000	20/30/40/50	22/33/44/53	10.10 ⁻⁴	14
17 (0.669)	50.5 (1.988) 60 (2.362) 81 (3.189)	30.5 (1.201) 40 (1.575) 61 (2.402)	Y5T	HB.. 00 ... M-- HB .. 00 ... M-- HF.. 00 ... M--	16 250	8 15	30 60	150.10 ⁻⁴	15
26.5 (1.043) 39.5 (1.555) 56.5 (2.224)	33 (1.300) 33 (1.300) 40 (1.575) 45 (1.772)	16 (0.630) 16 (0.630) 19 (0.748) 21 (0.827)	(N)	X HD .. 0Y....S-- HE .. 0Y....S--	250/500 1000 2000/3000	15 15 15/20	20 20 20/30	20.10 ⁻⁴	16
precise dividing ratio according to customer requirements									
27 (1.063)/ 34 (1.339) 39 (1.535)/ 44 (1.732) 54 (2.126)/ 55 (2.165)	37 (1.457)/ 40 (1.575) 37 (1.457)/ 40 (1.575) 40 (1.575)/ 47 (1.850)	23 (0.906)/ 28 (1.100) 23 (0.906)/ 28 (1.100) 21 (0.827)/ 28 (1.100)	Z5U	X HR .. 0Y....S-- HS .. 0Y....S--	470 5000	16/20	24/30	200.10 ⁻⁴	18
25.5 (1.004) 38 (1.500) 56 (2.205)	50 (1.969) 50 (1.969) 55 (2.165)	30 (1.180) 30 (1.180) 35 (1.378)	P100 N33 N470 N750	A0 HT .. HO F-- HU .. T0 K-- HU .. U0 M--	4.7 270	10/17	15/25	20.10 ⁻⁴	19

General Characteristics

HIGH VOLTAGE USES AND REQUIREMENTS

- High voltage uses are numerous but they can be divided into 3 main applications:
 - high voltage / AC or power frequency
 - high voltage / DC
 - high energy pulses
- Each of them requires specific properties leading to the use of different kinds of ceramic dielectrics and product types.

HIGH VOLTAGE / AC USES

- The main applications include live line indicators, AC dividers, grading systems for power distribution network, protection for HV switches and power circuit breakers. Coupling, by-passing high frequencies circuits where an important reactive power is needed also use ceramic HV capacitors.
- These applications require:
 - a high internal resistance
 - a high dielectric strengthtogether with:
 - low or moderate losses at working frequencies (from 50 Hz up to a few kHz).The active power (or losses) being:
$$W_a = 2\pi f C \cdot \tan \delta \cdot V^2 = k (C \cdot \tan \delta) (F \cdot V^2),$$
this shows that improved performance is obtained when both
 - good dielectric properties (low $\tan \delta$) and
 - no long term overvoltage occurs
 - capacitors free of "partial discharge" (corona) effect, up to rated rms voltage.TPC is able to perform discharge free test and may guarantee a rate as low as 5 picocoulombs at V_{rms} upon request.
- High voltage capacitors for AC uses are mainly made of type II dielectrics. These materials exhibit a significant non-linearity: the capacitance value depends on the voltage across the component and on the frequency of the applied signal.

HIGH VOLTAGE / DC USES

- The main applications are coupling, decoupling, multipliers circuits, HV DC power supplies.
- They require
 - a high internal resistance, even at elevated temperature
 - a very high dielectric strength
 - a low ripple current
- Type I or type II capacitors can be used depending on the particular application.

HIGH ENERGY PULSES

- Laser pulses circuitry, high energy/high voltage test equipment (HV accelerators, physics research) require products especially adapted to their specific requirements.
- Because of the high energy involved, the design of the capacitors have to provide:

- a very low ESR (equivalent series resistance) to minimize the losted energy

$$W = \int_0^{i_p} (ESR \cdot I^2) di$$

- a very low ESL (equivalent series inductance) to keep the correct pulse shape.

Typically, TPC products exhibit

ESR 10 mΩ
ESL 30 nH
peak current up to 50 kA

- a high withstanding of very large $\frac{dV}{dt}$ or short signal rise time

- a high energy density J

$$J = \frac{1}{2} k \epsilon_0 \epsilon_r E^2$$

even under high electric field, implying that ϵ_r is very little voltage dependent.

Through the use of almost linear or non-voltage dependent capacitors, the stored energy can reach 50 to 100 J/liter for TPC products.

- To ensure these properties, traditional ferroelectric type II capacitors cannot be used due to their electrostrictive and piezoelectric properties. TPC capacitors use quasi "para-electric", strontium-based, ceramic material.

High Voltage Ceramic Capacitors



HZ Type - Strontium-based Dielectric

FEATURES

- Good energy pulses ability
- Excellent heat-proof, humidity-proof characteristics
- High dielectric strength
- Epoxy coating
- High insulation resistance
- Small size and low cost
- Excellent Corona-proof

APPLICATIONS

- High-voltage DC Supply (X-Ray, Gas laser, ...)
- Lightning arrester in voltage distribution systems
- TV doubler & tripler
- Electrostatic copying machines

MARKING

- On each part: type (HZ), capacitance
- On packaging: reference, lot number

HZ RANGE – RADIAL TYPE (U_e=1.5X_{UR})

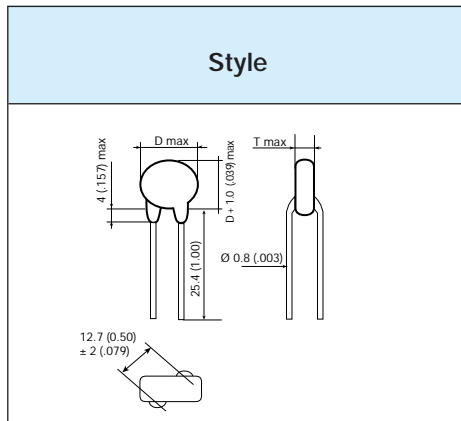

Reference	Cap. ±20% (pF)	UR (kVdc)			Dimensions millimeters (inches)	
		T 6	U 9	W 12	D	T
HZ09...	100				9.50 (0.374)	9.00 (0.354)
	150				9.50 (0.374)	9.00 (0.354)
	220				9.50 (0.374)	9.00 (0.354)
HZ12...	250				12.00 (0.472)	9.00 (0.354)
	330				12.00 (0.472)	9.00 (0.354)
	430				12.00 (0.472)	9.00 (0.354)
HZ16...	500				16.00 (0.630)	9.00 (0.354)
	680				16.00 (0.630)	9.00 (0.354)
	820				16.00 (0.630)	9.00 (0.354)
HZ18...	750				18.00 (0.709)	9.00 (0.354)
	1000				18.00 (0.709)	9.00 (0.354)
	1300				18.00 (0.709)	9.00 (0.354)
HZ20...	1000				20.00 (0.787)	9.00 (0.354)
	1300				20.00 (0.787)	9.00 (0.354)
	1800				20.00 (0.787)	9.00 (0.354)
HZ22...	1250				22.00 (0.866)	10.00 (0.394)
	1600				22.00 (0.866)	10.00 (0.394)
	2200				22.00 (0.866)	10.00 (0.394)
HZ26...	1500				26.00 (1.024)	11.00 (0.433)
	2000				26.00 (1.024)	11.00 (0.433)
	2700				26.00 (1.024)	11.00 (0.433)

TYPICAL CURVES

ELECTRICAL CHARACTERISTICS

• Rated voltage	6.9, 12 kVdc
• Test voltage (in oil)	1.5xU _R
• Capacitance change vs DC voltage	±10%
• Temperature characteristic within +10, +85°C	N4700
• Dissipation factor	< 10.10 ⁻⁴
• Insulation resistance (1000 V _{DC} / 60 s)	> 10 G Ω
• Capacitance range (25°C - 1 kHz - 1 V _{rms})	100pF to 2700pF
• Tolerance on capacitance	±20% (M)

Capacitance changes vs temperature

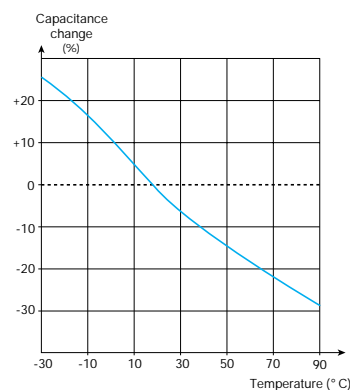

Capacitance change vs DC bias

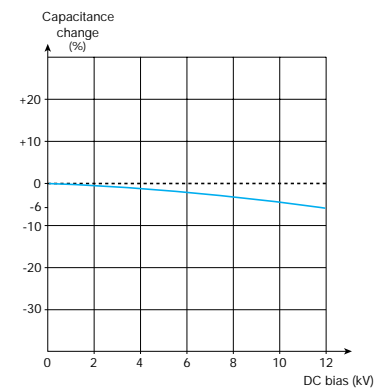

High Voltage Ceramic Capacitors



HP Type - Strontium-based Dielectric

FEATURES

- Excellent behavior on pulse and discharge conditions
- Excellent capacitance vs voltage characteristic
- Optimized size, epoxy coating
- Low dissipation factor
- Very low Corona effect

APPLICATIONS

- High-voltage supply for gas lasers
- Marx generators
- Power generators
- Copying machines
- Electronic microscopes

REFERENCES - VOLTAGE AND CAPACITANCE RANGE

Style	Rated Voltage kVdc	Test Voltage kVrms	Reference	AC Corona inception voltage (kV) <5 pico C 50Hz	Capacitance ± 20% (pF)	Dimensions millimeters (inches)			
						D ±1	d	L ±1	h ±2
	20	22	HP 30 E Y 0751 M.-.	10	750	28 (1.100)	12 (0.472)	23 (0.906)	17 (0.669)
			HP 40 E Y 0142 M.-.		1400	38 (1.500)	12 (0.472)	23 (0.906)	17 (0.669)
			HP 40 E Y 0152 M.-.		1500	38 (1.500)	12 (0.472)	23 (0.906)	17 (0.669)
			HP 50 E Y 0202 M.-.		2000	48 (1.900)	12 (0.472)	23 (0.906)	17 (0.669)
			HP 50 E Y 0252 M.-.		2500	48 (1.900)	12 (0.472)	23 (0.906)	17 (0.669)
			HP 60 E Y 0302 M.-.		3000	58 (2.283)	15 (0.591)	23 (0.906)	17 (0.669)
	HP 60 E Y 0402 M.-.	4000	58 (2.283)	15 (0.591)	23 (0.906)	17 (0.669)			
	30	33	HP 30 E 3 0511 M.-.	15	510	28 (1.100)	12 (0.472)	26 (1.024)	20 (0.787)
			HP 40 E 3 0941 M.-.		940	38 (1.500)	12 (0.472)	26 (1.024)	20 (0.787)
			HP 40 E 3 0102 M.-.		1000	38 (1.500)	12 (0.472)	26 (1.024)	20 (0.787)
			HP 50 E 3 0152 M.-.		1500	48 (1.900)	12 (0.472)	26 (1.024)	20 (0.787)
			HP 50 E 3 0172 M.-.		1700	48 (1.900)	12 (0.472)	26 (1.024)	20 (0.787)
HP 60 E 3 0202 M.-.			2000		58 (2.283)	15 (0.591)	26 (1.024)	20 (0.787)	
40	44	HP 30 E 4 0391 M.-.	20	390	28 (1.100)	12 (0.472)	30 (1.180)	24 (0.945)	
		HP 40 E 4 0701 M.-.		700	38 (1.500)	12 (0.472)	30 (1.180)	24 (0.945)	
		HP 40 E 4 0721 M.-.		720	38 (1.500)	12 (0.472)	30 (1.180)	24 (0.945)	
		HP 50 E 4 0102 M.-.		1000	48 (1.900)	12 (0.472)	30 (1.180)	24 (0.945)	
		HP 50 E 4 0132 M.-.		1300	48 (1.900)	12 (0.472)	30 (1.180)	24 (0.945)	
		HP 60 E 4 0152 M.-.		1500	58 (2.283)	15 (0.591)	32 (1.260)	26 (1.024)	
50	53	HP 40 E 5 0561 M.-.	25	560	38 (1.500)	12 (0.472)	35 (1.378)	29 (1.142)	
		HP 50 E 5 0112 M.-.		1100	48 (1.900)	12 (0.472)	35 (1.378)	29 (1.142)	
		HP 60 E 5 0172 M.-.		1700	58 (2.283)	15 (0.591)	35 (1.378)	29 (1.142)	

- Other tolerance on capacitance value, 50 kV voltage: please consult us.

- Tightening torque: 0.3 m.daN max

MARKING

- On each part: logo, type, capacitance, rated voltage, manufacturing date
- On packaging: reference, lot number

ELECTRICAL CHARACTERISTICS

• Rated voltage (V_R)	20 to 50 kVdc
• Test voltage (V_E) (50Hz, in oil, 60 s without destruction)	22 to 53 kV _{RMS}
• Temperature ranges storage operating	-40 +125°C -30 +85°C
• Temperature characteristic	N4700
• Dissipation factor (25°C, 1 kHz, 1 V _{rms})	< 10.10 ⁻⁴
• Insulation resistance (1000 V _{DC} / 60 s)	> 100 G Ω
• Capacitance range (25°C - 1 kHz - 1 V _{rms})	390pF to 4000pF
• Tolerance	±20%
• Self-inductance	60 nH

TYPICAL CURVES

Capacitance and dissipation factor changes vs temperature, DC voltage, frequency

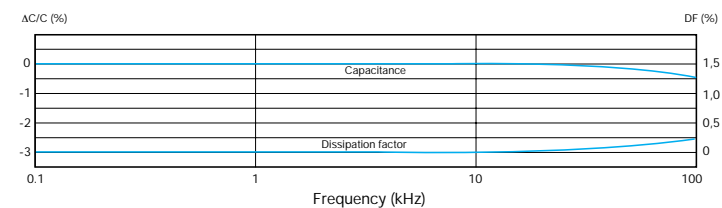
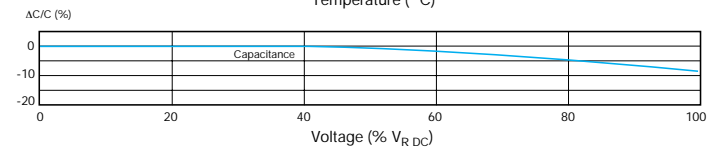
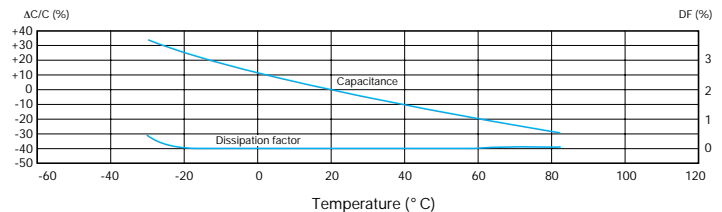

High Voltage Ceramic Capacitors



HB/HF Types - Type II

FEATURES

- These rod capacitors are designed for capacitive AC voltage dividers at 50/60 Hz frequency.

APPLICATIONS

- In HV mains supply (V_R), phase presence is checked by pilot lights. These lamps are supplied with a low voltage (V_d) which is obtained by means of capacitive divider according to the formula:

$$V_d = \left(\frac{C_2}{C_1 + C_2} \right) V_R$$

- Two versions are available:
 - HF type: unprotected rod with connections
 - HB type: unprotected metallized rod

- HB/HF types are for the high voltage section of the divider (C_2).

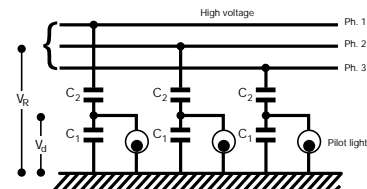

REFERENCES - VOLTAGE AND CAPACITANCE RANGE

Style	Reference	CR (pF)	VR kVRMS	VE kVRMS	Corona level <5 pico C kVRMS	Dimensions millimeters (inches)			Weight g
						D	L	I	
	HF60001250M.-.-	125	15	60	>14	17 (0.669)	81 (3.189)	61 (2.402)	115
	HF60000101M.-.-	100	15	60	>14	17 (0.669)	81 (3.189)	61 (2.402)	115
	HF60000500M.-.-	50	15	60	>14	17 (0.669)	81 (3.189)	61 (2.402)	115
	HF60000250M.-.-	25	15	60	>14	17 (0.669)	81 (3.189)	61 (2.402)	115
	HF60000160M.-.-	16	15	60	>14	17 (0.669)	81 (3.189)	61 (2.402)	115
	HF40000181M.-.-	180	11	42	>11	17 (0.669)	60 (2.362)	40 (1.575)	80
	HF40000750M.-.-	75	11	42	>11	17 (0.669)	60 (2.362)	40 (1.575)	80
	HF40000360M.-.-	36	11	42	>11	17 (0.669)	60 (2.362)	40 (1.575)	80
	HF40000240M.-.-	24	11	42	>11	17 (0.669)	60 (2.362)	40 (1.575)	80
	HF30000251M.-.-	250	8	30	>8	17 (0.669)	50.5 (1.988)	30.5 (1.201)	65
HF30000101M.-.-	100	8	30	>8	17 (0.669)	50.5 (1.988)	30.5 (1.201)	65	
HF30000480M.-.-	48	8	30	>8	17 (0.669)	50.5 (1.988)	30.5 (1.201)	65	
HF30000320M.-.-	32	8	30	>8	17 (0.669)	50.5 (1.988)	30.5 (1.201)	65	
	HB60001250M.-.-	125	15	60	>14	17 (0.669)	/	61 (2.402)	110
	HB60000101M.-.-	100	15	60	>14	17 (0.669)	/	61 (2.402)	110
	HB60000500M.-.-	50	15	60	>14	17 (0.669)	/	61 (2.402)	110
	HB60000250M.-.-	25	15	60	>14	17 (0.669)	/	61 (2.402)	110
	HB60000160M.-.-	16	15	60	>14	17 (0.669)	/	61 (2.402)	110
	HB40000181M.-.-	180	11	42	>11	17 (0.669)	/	40 (1.575)	70
	HB40000750M.-.-	75	11	42	>11	17 (0.669)	/	40 (1.575)	70
	HB40000360M.-.-	36	11	42	>11	17 (0.669)	/	40 (1.575)	70
	HB40000240M.-.-	24	11	42	>11	17 (0.669)	/	40 (1.575)	70
	HB30000251M.-.-	250	8	30	>8	17 (0.669)	/	30.5 (1.201)	55
	HB30000101M.-.-	100	8	30	>8	17 (0.669)	/	30.5 (1.201)	55
	HB30000480M.-.-	48	8	30	>8	17 (0.669)	/	30.5 (1.201)	55
	HB30000320M.-.-	32	8	30	>8	17 (0.669)	/	30.5 (1.201)	55

Important:

Handling of uncoated types must be done under strict cleanliness conditions.

Special types

Other models with different dimensions and capacitance can also be supplied upon request.

ELECTRICAL CHARACTERISTICS

• Capacitance range (at V_{Rms})	16 to 250pF
• Capacitance tolerance	±20% (±10%: consult us)
• Rated voltage (V_R)	8 kV _{rms} to 15 kV _{rms}
• Test voltage (V_E) - measurement made in a dielectric fluid (ref. F113) during 1 min	30 kV _{rms} to 60 kV _{rms}
• Dissipation factor (at V_{Rms})	$\tan \delta$ 150.10 ⁻⁴
• Ionization or corona voltage	Ui 8 kV _{rms} to 14 kV _{rms}
• Shock wave behavior (HB/HF types)	140 kVc (1.2/50 μ s wave)
• Main parameters change vs temperature, voltage	See typical curves

Note: For other electrical characteristics, please consult us.

TYPICAL CURVES

Capacitance change vs temperature

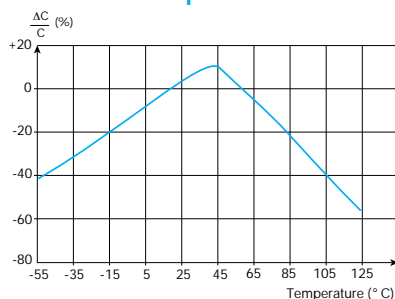

Capacitance change vs voltage

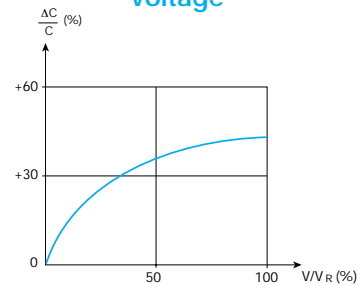

SPECIAL TYPES

According to specific customer requirements, TPC has developed special types to mold like:

- Coated rod capacitors
- Rod capacitors with assembled terminals

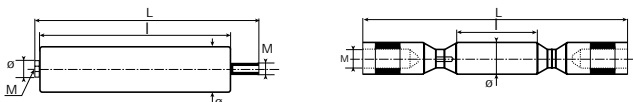

Dimensions, electrical characteristics can be adapted upon request.

High Voltage Ceramic Capacitors



HD/HE Types - Type II (N)

FEATURES

- Disc capacitor, type II
- Excellent capacitance vs voltage characteristic
- Low dissipation factor
- Good behavior on frequency
- Two available versions:
 - HD: Molded type with connections
 - HE: Uncoated type without connections (silvered ceramic)

APPLICATIONS

- AC voltage dividers at industrial frequency
- High frequency decoupling
- Other special applications

REFERENCES - VOLTAGE AND CAPACITANCE RANGE

Style	Reference	C _R (pF)	V _R (kVc-)	V _E (kVc-)	Dimensions millimeters (inches)						Torque S (m.daN)	Weight (g)	
					D	L	h	∅	d	p			e
	HD 30 0X 0251S--	250	15	20	26.5 (1.043)	33 (1.300)	16 (0.630)	8 (0.315)	5 (0.197)	9 (0.354)	7 (0.276)	0.3	30
	HD 30 0X 0501S--	500	15	20	26.5 (1.043)	33 (1.300)	16 (0.630)	8 (0.315)	5 (0.197)	9 (0.354)	7 (0.276)	0.3	30
	HD 40 0X 0102S--	1000	15	20	39.5 (1.555)	33 (1.300)	16 (0.630)	8 (0.315)	5 (0.197)	9 (0.354)	7 (0.276)	0.3	60
	HD 60 0Y 0202S--	2000	20	30	56.5 (2.224)	45 (1.772)	21 (0.827)	12 (0.472)	8 (0.315)	11 (0.433)	10 (0.394)	1	160
	HD 60 0X 0302S--	3000	15	20		40 (1.575)	19 (0.748)						135
Important: HD type In order to improve capacitor mounting, connections ends are designed with two flats. Thus, tightening torque is only applied on the screw (consult chart above for torque "S" value).		Hardware supplied for capacitor mounting 2 x screws TCB M5 L8 or TCB M8 L12 2 x washers according to ∅											
	HB 30 0X 0251S--	250	15	20	12 (0.472)	—	8 (0.315)						
	HB 30 0X 0501S--	500	15	20	17 (0.669)	—	9 (0.354)						
	HB 40 0X 0102S--	1000	15	20	26 (1.024)	—	9 (0.354)						
	HB 60 0Y 0202S--	2000	20	30	42 (1.654)	—	12 (0.472)						
	HB 60 0X 0302S--	3000	15	20	42 (1.654)	—	9 (0.354)						
Important: HE type Handling of uncoated types must be done under strict cleanliness conditions.													

MARKING

- TPC - Reference (HTD)
- Capacitance
- Rated voltage

ELECTRICAL CHARACTERISTICS

• Operating temperature range	-30 +85°C (+125°C: consult us)
• Rated voltage (V _{rms} /50 Hz)	15 kV or 20 kV
• Test voltage (V _{rms} /50 Hz)	20 kV or 30 kV
• Capacitance range	250 to 3000pF
• Capacitance tolerance	-20 +50% (S)
• Dissipation factor	tg δ ≤ 20.10 ⁻⁴
• Self-inductance	L ≤ 30 nH
• Main parameters change vs applied voltage, temperature and frequency	See typical curves

TYPICAL CURVES

Capacitance change vs temperature

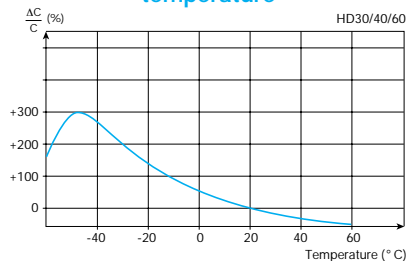

Capacitance change vs applied voltage

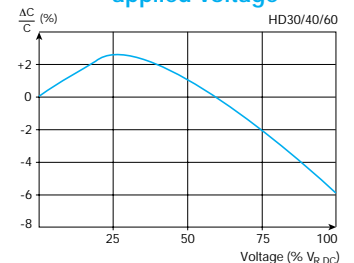

Maximum reactive power (W_R), voltage (V_R), current (I_{RMS}) vs frequency

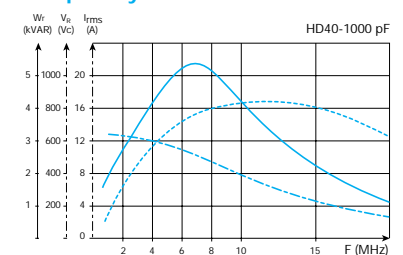
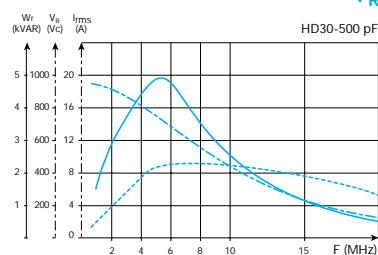

High Voltage Ceramic Capacitors



Custom Designed Live-Line Dividers

APPLICATIONS

TPC is able to study and design live-line dividers to customers specifications, up to 150 KV_{rms}.

They can be used for:

- voltage presence indication
- voltage presence alarm
- voltage measurement

PRINCIPLE OF USE

- Using the following equivalent circuit

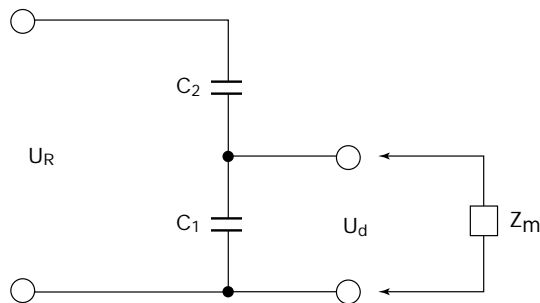

with:

- V_R : rated voltage of the line
- V_d : low voltage output
- C_1 : low voltage / high value capacitor
- C_2 : high voltage / low value capacitor
- Z_m : measuring impedance
- Z_t : impedance of C_1 at 50/60 Hz

the low voltage output is obtained by

$$V_d = \left(\frac{C_2}{C_1 + C_2} \right) V_R$$

the ratio $\frac{C_2}{C_1 + C_2}$ being adjusted to the expected value.

- For measurement application, the measurement impedance Z_m must be larger than at least 10 times Z_t in order not to affect the dividing ratio where:

$$Z_t = \frac{1}{\left(\frac{C_1 \cdot C_2}{C_1 + C_2} \right) \omega}$$

FEATURES

The high and low voltage elements can be supplied either separately or in the same molding.

The capacitor divider ratio can be adjusted between 1/200 and 1/10 together with a tolerance that can be as tight as 2%.

The products can be developed for rated line voltage from 10kV up to 150 KV_{rms}.

TYPICAL EXAMPLES

- Style "A"

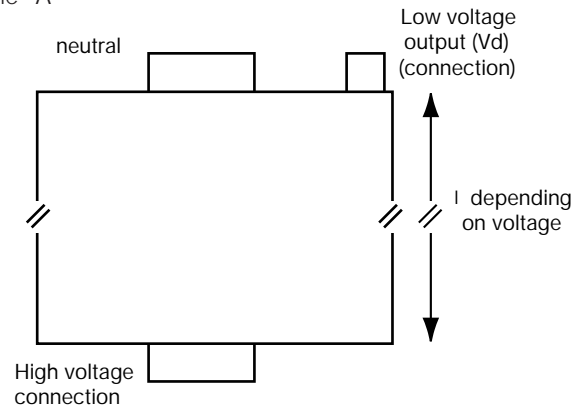

- Style "B"

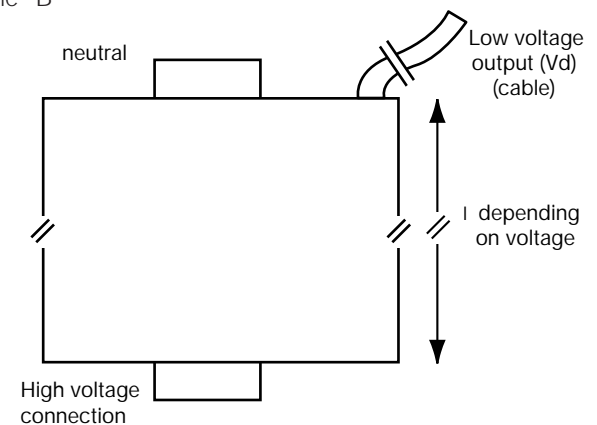

For dimensions, capacitances, voltages, ratio, please consult your local sales office.

High Voltage Ceramic Capacitors



HR/HS Types - Type II

FEATURES

- Disc capacitor, type II
- Two available versions:
 - HR: Molded type with connections
 - HS: Uncoated type without connections (silvered ceramic)

APPLICATIONS

- DC high voltage applications

REFERENCES - VOLTAGE AND CAPACITANCE RANGE

Style	Reference	C _R (pF)	V _R (kVc-)	V _E (kVc-)	Dimensions millimeters (inches)								Torque S (m.daN)	Weight (g)
					D	D ₁	L	h	∅	d	p	e		
	HR 30 0X 0471S--	470	16	24	27 (1.063)	25 (0.984)	37 (1.457)	23 (0.906)	8 (0.315)	5 (0.197)	9 (0.354)	7 (0.276)	0.3	32
	HR 30 0Y 0471S--	470	20	30	34 (1.339)	32 (1.260)	40 (1.575)	28 (1.100)	8 (0.315)	5 (0.197)	9 (0.354)	7 (0.276)	0.3	45
	HR 40 0X 0102S--	1000	16	24	39 (1.535)	37 (1.457)	37 (1.457)	23 (0.906)	8 (0.315)	5 (0.197)	9 (0.354)	7 (0.276)	0.3	65
	HR 40 0Y 0102S--	1000	20	30	44 (1.732)	42 (1.654)	40 (1.575)	28 (1.100)	8 (0.315)	5 (0.197)	9 (0.354)	7 (0.276)	0.3	90
	HR 60 0Y 0222S--	2200	20	30	54 (2.126)	52 (2.047)	47 (1.850)	28 (1.100)	12 (0.472)	8 (0.315)	13 (0.512)	10 (0.394)	1	180
	HR 60 0X 0502S--	5000	16	24	55 (2.165)	54 (2.126)	40 (1.575)	21 (0.827)	12 (0.472)	8 (0.315)	13 (0.512)	10 (0.394)	1	180
Important: HR type In order to improve capacitor mounting, connections ends are designed with two flats. Thus, tightening torque is only applied on the screw (consult chart above for torque "S" value).		Hardware supplied for capacitor mounting 2 x screws TCB M5 L8 or TCB M8 L12 2 x washers										according to ∅		
	HS 30 0X 0471S--	470	16	24	17 (0.669)	—	—	13 (0.512)						
	HS 30 0Y 0471S--	470	20	30	19 (0.748)	—	—	17 (0.669)						
	HS 40 0X 0102S--	1000	16	24	26 (1.024)	—	—	14 (0.551)						
	HS 40 0Y 0102S--	1000	20	30	29 (1.142)	—	—	16 (0.630)						
	HS 60 0Y 0222S--	2200	20	30	37 (1.457)	—	—	14 (0.551)						
	HS 60 0X 0502S--	5000	16	24	42 (1.654)	—	—	8 (0.315)						
Handling of uncoated types must be done under strict cleanliness conditions.														

SPECIAL TYPES

Upon request:

- Metallized uncoated ceramic disc with connections
- Stacks with coated or uncoated units from standard ceramic disc

MARKING

- Reference (HTX)
- Capacitance
- Rated voltage

ELECTRICAL CHARACTERISTICS

• Operating temperature range	-55 +85°C (+125°C: consult us)
• Rated voltage (V _{rms} /50 Hz)	16 kV or 20 kV
• Test voltage (V _{rms} /50 Hz)	24 kV or 30 kV
• Capacitance range (F = 1 kHz / T = 25°C / U _m = 1 V _{rms})	470 to 5000pF
• Capacitance tolerance on rated capacitance	-20 +50% (S)
• Dissipation factor	tg δ ≤ 200.10 ⁻⁴
• Insulation resistance (U _m = 1000 V / 1 mn)	Ri ≥ 10 G Ω
• Self-inductance	L ≤ 0.03 μH
• Main parameters change vs applied voltage, temperature	See typical curves

TYPICAL CURVES

Capacitance change vs temperature

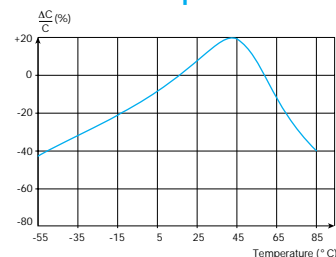

Capacitance change vs applied voltage

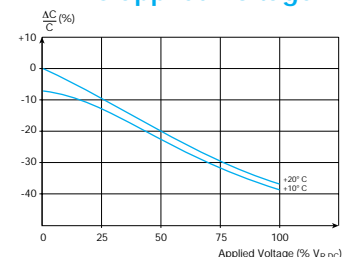

High Voltage Ceramic Capacitors



HT/HU Types - Type I

FEATURES

- Disc capacitor, type I
- Low reactive power
- High stability vs temperature
- No capacitance change vs voltage
- Two available versions:
 - HT: Molded type with connections
 - HU: Uncoated type without connections (silvered ceramic)

APPLICATIONS

- High voltage coupling
- High voltage tuning

TYPES AND DIMENSIONS

Style	Type/Size	Dimensions millimeters (inches)							Tightening torque S (m.daN)	
		D	L	h	Ø	d (ISO)	p	e		
	HT 30	25.5 (1.004)	50 (1.969)	30 (1.180)	8 (0.315)	5 (0.197)	9 (0.354)	7 (0.276)	0.3	
	HT 40	38 (1.500)	50 (1.969)	30 (1.180)	8 (0.315)	5 (0.197)	9 (0.354)	7 (0.276)	0.3	
	HT 60	56 (2.205)	55 (2.165)	35 (1.378)	12 (0.472)	8 (0.315)	13 (0.512)	10 (0.394)	1	
Important: HT type In order to improve capacitor mounting, connections ends are designed with two flats. Thus, tightening torque is only applied on the screw (consult chart above for torque "S" value).		Hardware supplied for capacitor mounting 2 x screws TCB M5 L8 or TCB M8 L12 2 x washers according to Ø								
	HU 30	22 (0.866)	-	Height h: Depending on capacitance please consult us						
	HU 40	30 (1.180)	-							
	HU 60	42 (1.654)	-							
Important: HU type Handling of uncoated types must be done under strict cleanliness conditions.										

TABLE OF VALUES

Type	Rated capacitance C _R (pF)	Rated voltage V _R (kV)	Test voltage V _E (kV / 50 Hz)	Capacitance vs temperature TC (ppm/°C)
HT/HU30A	4.7-5.6	17	25	+100 ±100
HT/HU30A	6.8	10	15	
HT/HU40A	8.2	17	25	
HT/HU40A	10-15	10	15	
HT/HU60A	18-22	17	25	
HT/HU60A	27-47	10	15	
HT/HU30H	10	17	25	-33 ±60
HT/HU30H	12	10	15	
HT/HU40H	15-22	17	25	
HT/HU40H	27-33	10	15	
HT/HU60H	39-47	17	25	
HT/HU60H	56-100	10	15	
HT/HU30T	22	10	15	-470 ±160
HT/HU40T	27-33	17	25	
HT/HU40T	39-56	10	15	
HT/HU60T	68-82	17	25	
HT/HU60T	100-150	10	15	
HT/HU30U	22-27	17	25	
HT/HU30U	33-39	10	15	
HT/HU40U	47-56	17	25	
HT/HU40U	68-100	10	15	
HT/HU60U	120-150	17	25	
HT/HU60U	180-270	10	15	

MARKING

- Reference (HT)
- Capacitance, tolerance
- Rated voltage

ELECTRICAL CHARACTERISTICS

• Climatic category	-55 +85°C, 21 days damp heat
• Rated voltage (DC voltage + HF peak)	10 kV or 17 kV
• Test voltage (V _{rms} /50 Hz)	15 kV or 25 kV
• Dissipation factor	C ≤50pF tg δ ≤ 20.10 ⁻⁴ C >50pF tg δ ≤ 20 ($\frac{15}{C} + 0.7$) .10 ⁻⁴
• Temperature coefficient	TC = +100 to -750 ppm/°C depending on capacitance value
• Tolerances and associated series	±1pF (F) ±10% (K) ±20% (M) C < 10pF E 12 E 6

LOT RELEASE

Every high voltage and power capacitor is inspected individually during manufacture.

They must, before shipping, satisfy the criteria of the quality control department.

Each lot is checked in accordance with defined sampling plans.

The tests are performed in accordance with the specifications hereunder.

MECHANICAL TESTS

Dimensions of each unit are inspected and must be in accordance with the characteristics specified on the particular data sheet.

OPERATING CLIMATIC CONDITIONS

TPC power capacitors temperature range, in normal utilization, is from -30°C to $+85^{\circ}\text{C}$.

However if provided power is decreased as previously indicated, it is possible to use them at higher temperatures.

Please refer to us.

ELECTRICAL TESTS

• Capacitance and tangent of loss angle (DF)

Tests are made at room temperature and the measurement conditions are:

Type I - $C < 1000\text{pF}$:

- measuring frequency: 1 MHz
 - measuring voltage: $\leq 10\text{ Vrms}$
- $C \geq 1000\text{ pF}$:
- measuring frequency: 1 kHz
 - measuring voltage: $\leq 10\text{ Vrms}$

Type II - $C < 100\text{pF}$:

- measuring frequency: 1 MHz
 - measuring voltage: $\leq 1\text{ Vrms}$
- $C \geq 100\text{pF}$:
- measuring frequency: 1 kHz
 - measuring voltage: $\leq 1\text{ Vrms}$

• Dielectric strength

This test is realized with DC or AC/50 Hz voltage (refer to individual data sheet for each type). Units are kept under applied voltage for 1 min.

• Insulation resistance

Insulation resistance value is warranted higher than $10\text{ G}\Omega$ after 1 min at 1000 VDC.

• Temperature coefficient

Temperature coefficients are measured with voltage less than 10V in temperature range from $+20^{\circ}\text{C}$ to $+85^{\circ}\text{C}$. Temperature coefficients are within the tolerances specified in particular data sheets.

High Voltage Ceramic Capacitors



Manufacturing Process

MANUFACTURING OF DIELECTRIC AND SEMI-FINISHED CAPACITORS

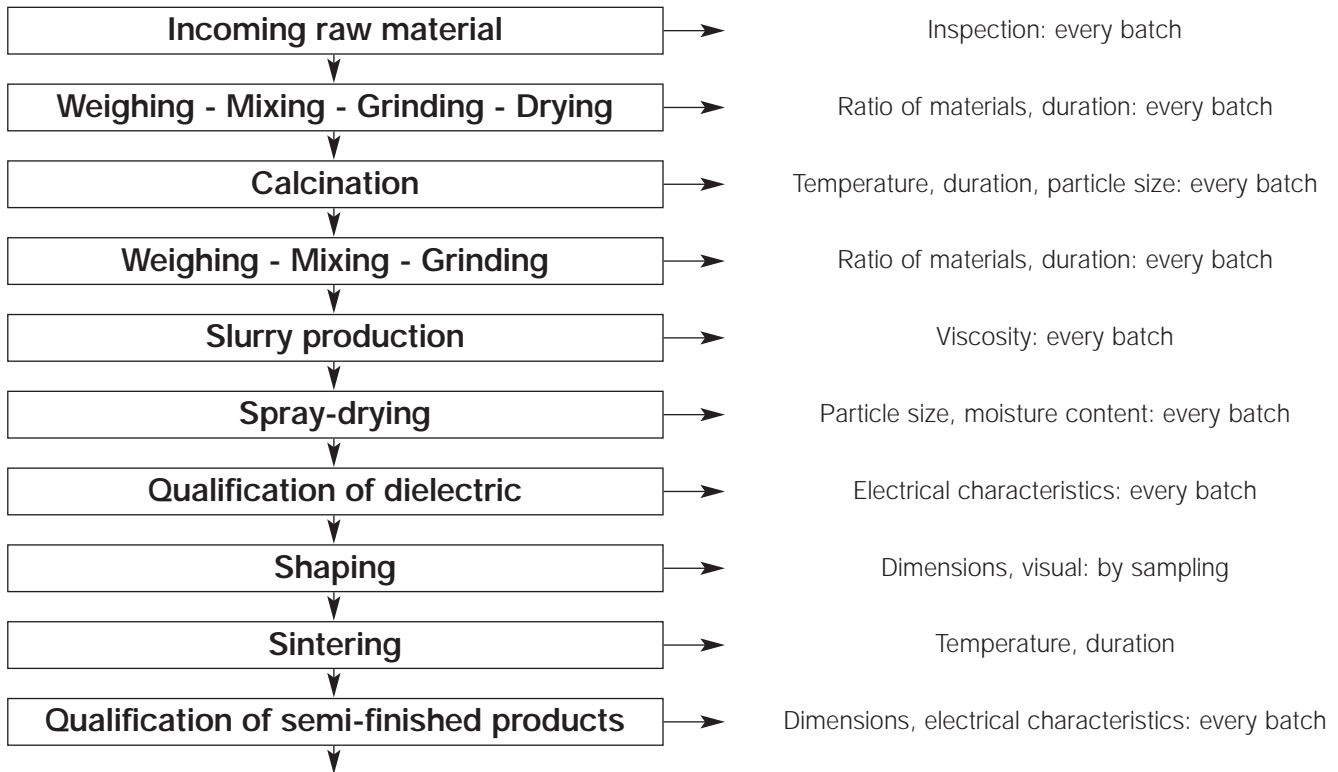

MANUFACTURING OF COATED CAPACITORS

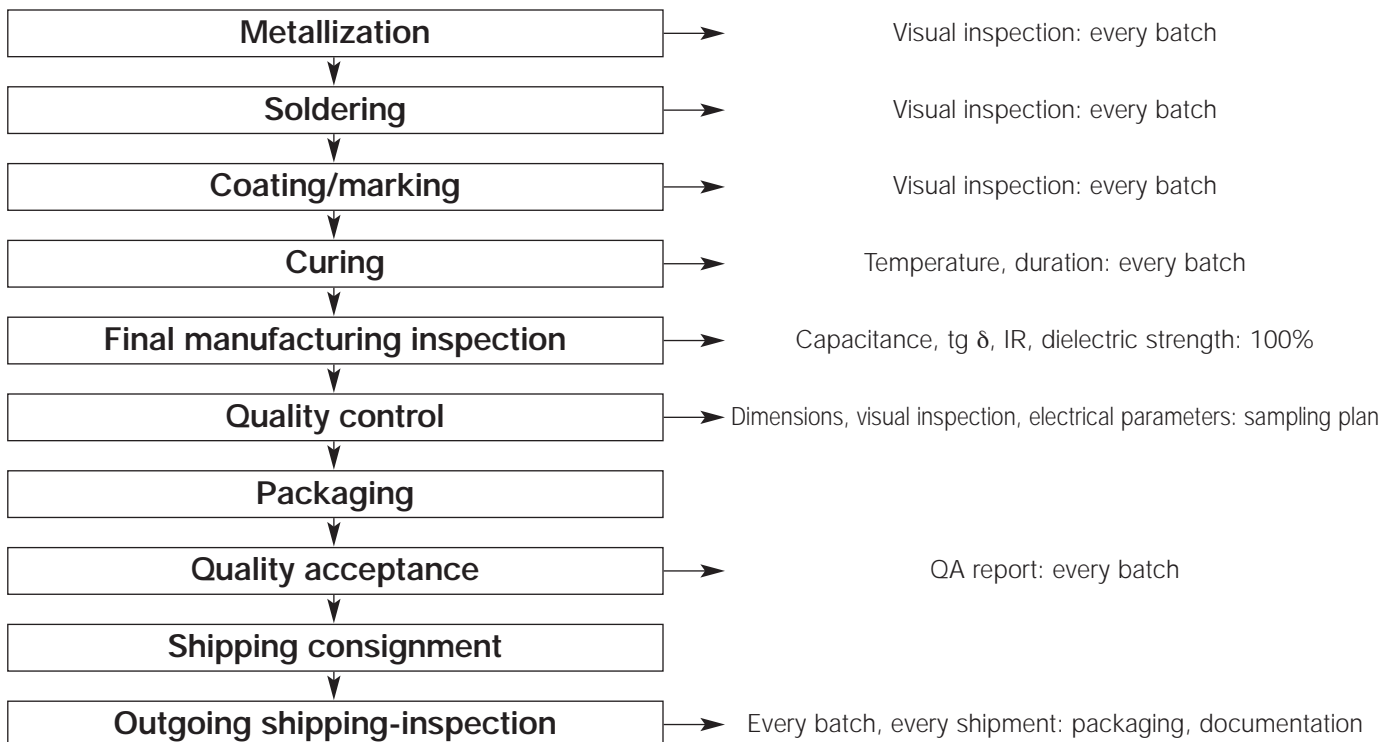

High Voltage Ceramic Capacitors



Marking - Packaging - Identification

MARKING

Each part is marked with the following indications:

- Logo
- Reference
- Rated capacitance (EIA code)
- Tolerance on capacitance (EIA code)
- Rated voltage

IDENTIFICATION - TRACEABILITY

On the packaging of all shipped capacitors, you will find a bar code label (code 39). This label gives systematic information on the type of product, part number, lot number, packing date and quantity.

An example is given below:

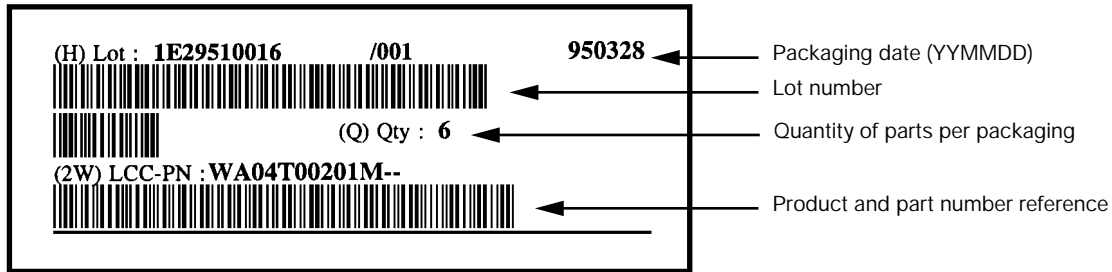

This information allows traceability of the entire manufacturing process, from critical raw materials to shipment. This is extremely useful for any information request, customer complaint or product return.

CROSS REFERENCES PREVIOUS REFERENCES / NEW REFERENCES

High Voltage	
Previous Reference	New Reference
HT030 ... 060	HT30 ... 60
HT030D ... 060D	HU30 ... 60
HTD230 ... 360	HD30 ... 60
HTD230D ... 360D	HE30 ... 60
HTX230 ... 360	HR30 ... 60
HTX230D ... 360D	HS30 ... 60
HTZ130 ... 160	HB30 ... 60
HTZ131 ... 161	HF30 ... 60

High Voltage Ceramic Capacitors



Questionnaire: How to Define a Capacitor

CUSTOM DESIGN REQUIREMENTS

Customer: _____ Date: _____
Country: _____

• What is your application:

- Coupling / Decoupling: _____
- Tuning: _____
- Smoothing: _____
- High energy pulses: _____
- Voltage divider: _____
- Voltage multiplier: _____

• What are the critical parameters in this application:

- Low cap. variation vs temperature: _____
- Guaranteed minimum cap. value (under T°C + Udc or ac): _____
- Low dielectric losses: _____ At low frequency: _____
- Low ESR: _____ At high frequency: _____
- Minimum I.R (M): _____ At what temperature: _____
- Other (describe): _____

• Signal

1. Pulse Signal
 - Peak voltage: _____
 - Rise time or dV/dt: _____
 - Peak current: _____
 - Recurrent frequency: _____
 - Energy stored: _____
2. Sine Wave
 - rms voltage: _____
 - rms current: _____
 - Frequency: _____
 - DC bias if any: _____
 - Reactive power: _____
 - Divider ratio: _____

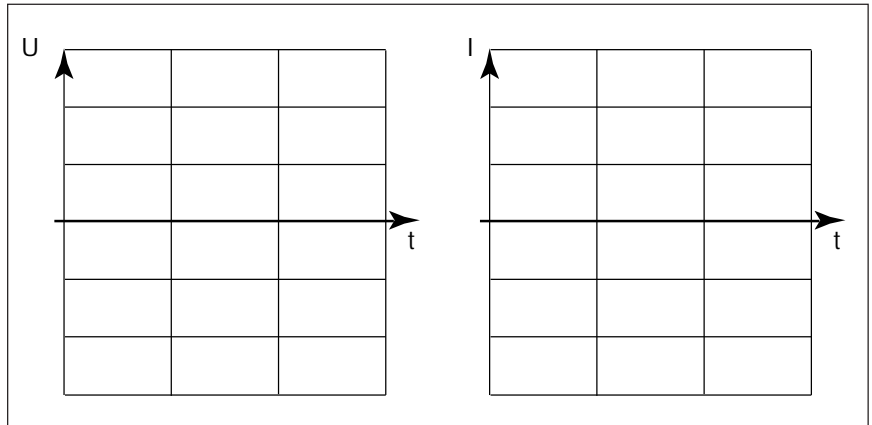

• Physical parameters

- Operating temperature range: _____
- Maximum weight: _____
- Mounting requirements: _____
- Maximum dimensions: _____

• Other requirements: _____

• Recommended product:

- Type / Size: _____
- Voltage: _____
- Capacitance: _____
- Tolerance: _____

High Voltage Ceramic Capacitors



Standard Series and Associated Tolerances

E 6 ±20%	E 12 ±10%	E 24 ±5%	E 48 ±2%	E 96 ±1%	
100	100	100	100	100	
			102	102	
			105	105	
			107	107	
			110	110	
		110	110	110	
			113	113	
			115	115	
			118	118	
			120	120	
	120	120	120	121	121
				124	124
			127	127	
			130	130	130
				133	133
		137		137	
		140	140		
		143	143		
		147	147		
		150	150	150	150
154	154				
158	158				
160	162			162	
	165			165	
	169		169		
174	174				
180	180		180	178	178
				182	182
			187	187	
		191	191		
		196	196		
	200	200	200		
		205	205		
		210	210		
		215	215		
		220	220		
220	220	220	221	221	
			226	226	
		232	232		
		240	237	237	
			243	243	
	249		249		
	255	255			
	261	261			
	270	270	267	267	
			274	274	
280		280			
287		287			
294		294			
300	300	301	301		
		309	309		

E 6 ±20%	E 12 ±10%	E 24 ±5%	E 48 ±2%	E 96 ±1%		
330	330	330	316	316		
			324	324		
			332	332		
			340	340		
			348	348		
		360	357	357		
			365	365		
			374	374		
			383	383		
			392	392		
	390	390	390	402	402	
				412	412	
			422	422		
			430	432	432	
				442	442	
		453		453		
		464	464			
		470	470	470	464	464
					475	475
				487	487	
499	499					
510	511			511		
	523		523			
	536		536			
	549		549			
	560		560			
560	560		560	562	562	
		576		576		
		590	590			
		604	604			
		619	619			
	620	634	634			
		649	649			
		665	665			
		681	681			
		698	698			
680	680	680	715	715		
			732	732		
		750	750			
		768	768			
		787	787			
	820	820	806	806		
			825	825		
		845	845			
		866	866			
		887	887			
910	910	909	909			
		931	931			
	953	953				
	976	976				

USA

AVX Myrtle Beach, SC Corporate Offices

Tel: 843-448-9411
FAX: 843-626-5186

AVX Northwest, WA

Tel: 360-669-8746
FAX: 360-699-8751

AVX North Central, IN

Tel: 317-848-7153
FAX: 317-844-9314

AVX Northeast, MA

Tel: 508-485-8114
FAX: 508-485-8471

AVX Mid-Pacific, CA

Tel: 408-436-5400
FAX: 408-437-1500

AVX Southwest, AZ

Tel: 602-539-1496
FAX: 602-539-1501

AVX South Central, TX

Tel: 972-669-1223
FAX: 972-669-2090

AVX Southeast, NC

Tel: 919-878-6357
FAX: 919-878-6462

AVX Canada

Tel: 905-564-8959
FAX: 905-564-9728

EUROPE

AVX Limited, England European Headquarters

Tel: ++44 (0)1252 770000
FAX: ++44 (0)1252 770001

AVX S.A., France

Tel: ++33 (1) 69.18.46.00
FAX: ++33 (1) 69.28.73.87

AVX GmbH, Germany - AVX

Tel: ++49 (0) 8131 9004-0
FAX: ++49 (0) 8131 9004-44

AVX GmbH, Germany - Elco

Tel: ++49 (0) 2741 2990
FAX: ++49 (0) 2741 299133

AVX srl, Italy

Tel: ++390 (0)2 614571
FAX: ++390 (0)2 614 2576

AVX sro, Czech Republic

Tel: ++420 (0)467 558340
FAX: ++420 (0)467 558345

ASIA-PACIFIC

AVX/Kyocera, Singapore Asia-Pacific Headquarters

Tel: (65) 258-2833
FAX: (65) 350-4880

AVX/Kyocera, Hong Kong

Tel: (852) 2-363-3303
FAX: (852) 2-765-8185

AVX/Kyocera, Korea

Tel: (82) 2-785-6504
FAX: (82) 2-784-5411

AVX/Kyocera, Taiwan

Tel: (886) 2-2696-4636
FAX: (886) 2-2696-4237

AVX/Kyocera, China

Tel: (86) 21-6249-0314-16
FAX: (86) 21-6249-0313

AVX/Kyocera, Malaysia

Tel: (60) 4-228-1190
FAX: (60) 4-228-1196

Elco, Japan

Tel: 045-943-2906/7
FAX: 045-943-2910

Kyocera, Japan - AVX

Tel: (81) 75-604-3426
FAX: (81) 75-604-3425

Kyocera, Japan - KDP

Tel: (81) 75-604-3424
FAX: (81) 75-604-3425

Contact:



<http://www.avxcorp.com>

S-HVC7.5M1199-C