

Molded, 50 Mil Pitch Resistor Networks

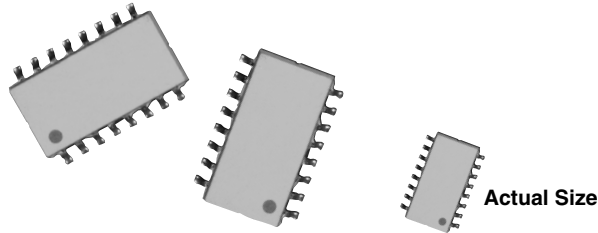

FEATURES

- Lead (Pb)-free available
- 0.090" (2.29 mm) maximum seated height
- Rugged, molded case construction (0.22" wide)
- Highly stable thin film (500 ppm at 70 °C, 10 000 hours)
- Low temperature coefficient, ± 25 ppm/°C (-55 °C to +125 °C)
- Wide resistance range 100 Ω to 100 k Ω

RoHS*
COMPLIANT

Vishay Thin Film offers standard circuits in 16 pin a medium body molded surface mount package. The networks are available over a resistance range of 100 Ω to 100 k Ω . The network features tight ratio tolerances and close TCR tracking. In addition to the standards shown, custom circuits are available upon request.

SCHEMATIC

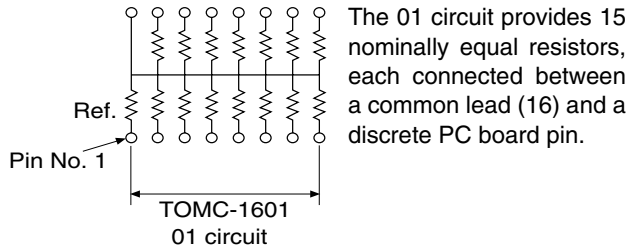

TYPICAL PERFORMANCE

	ABS	TRACKING
TCR	25	5
	ABS	RATIO
TOL	0.1	0.025

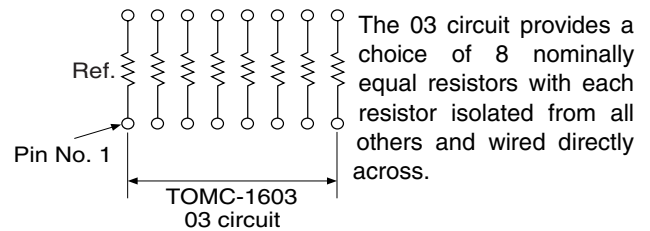

STANDARD ELECTRICAL SPECIFICATIONS

TEST	SPECIFICATIONS	CONDITIONS
Pin number	16	
Resistance Range	100 Ω to 100 k Ω	
TCR:	Tracking	± 5 ppm/°C
	Absolute	± 25 ppm/°C
Tolerance:	Ratio	$\pm 0.5\%$, $\pm 0.1\%$, $\pm 0.05\%$, $\pm 0.025\%$
	Absolute	$\pm 0.1\%$, $\pm 0.5\%$, $\pm 0.25\%$, $\pm 0.1\%$
Power Rating:	Resistor	Pin 1 Common = 50 mW Isolated = 100 mW
	Package	750 mW
Stability:	ΔR Absolute	500 ppm
	ΔR Ratio	150 ppm
Voltage Coefficient	0.1 ppm/V	
Working Voltage	50 V	
Operating Temperature Range	-55 °C to +125 °C	
Storage Temperature Range	-55 °C to +150 °C	
Noise	< -30 dB	
Thermal EMF	0.08 μ V/°C	
Shelf Life Stability:	Absolute	100 ppm
	Ratio	20 ppm
		1 year at +25 °C
		1 year at +25 °C

* Pb containing terminations are not RoHS compliant, exemptions may apply

DIMENSIONS AND IMPRINTING in inches and millimeters

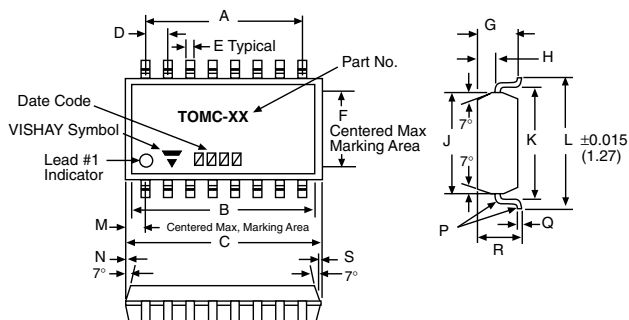

DIMENSION	INCHES	MM
D	0.050	1.27
E	0.018	0.457
F	0.160	4.06
G	0.08	2.03
H	0.036	0.914
J	0.22	5.59
K	0.244	6.20
L	0.30	7.52
M	0.045	1.14
N	0.003	0.076
P	0.005	1.27
Q	0.008	0.203
R	0.085	2.16
S	0.003	0.076

TYPE	A	B	C
16	0.350" (8.89)	0.400" (10.16)	0.440" (11.176)

DERATING CURVES

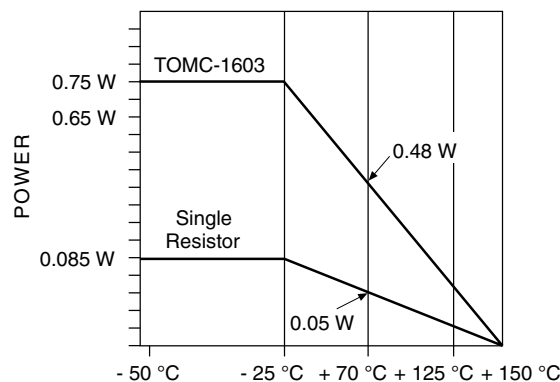
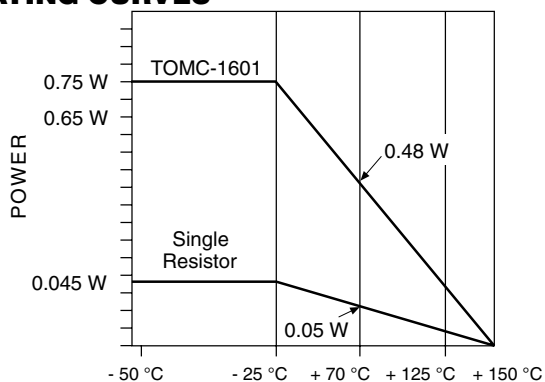

GLOBAL PART NUMBER INFORMATION

New Global Part Numbering: TOMC16031002BUF (preferred part number format)

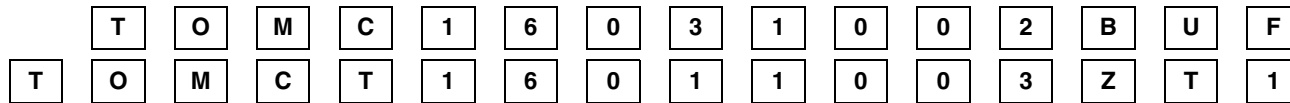

GLOBAL MODEL (4 or 5 digits)	PINS	SCHEMATIC	RESISTANCE	TOLERANCE AND RATIO TOLERANCE	PACKAGING
TOMC (Tin Lead)	16	01 = 15 bussed equal resistors	First 3 digits are significant figures and the last digit specifies the number of zeroes to follow. Example: 1002 = 10K 1003 = 100K	Abs. Tol. Ratio **A = 0.1 % 0.05 % B = 0.1 % 0.1 % C = 0.25 % 0.1 % D = 0.5 % 0.1 % F = 1 % 0.5 % *Z = 0.1 % 0.025 % * Tol. available 1K and up ** Tol. available 250 and up	TAPE AND REEL T0 = 100 Min 100 Mult T1 = 1000 Min 1000 Mult T3 = 300 Min 300 Mult T5 = 500 Min 500 Mult TF = Full Reel 2000 TS = 100 Min 1 Mult UF = TUBED

Historical Part Number example: TOMC16011002Z (will continue to be accepted)

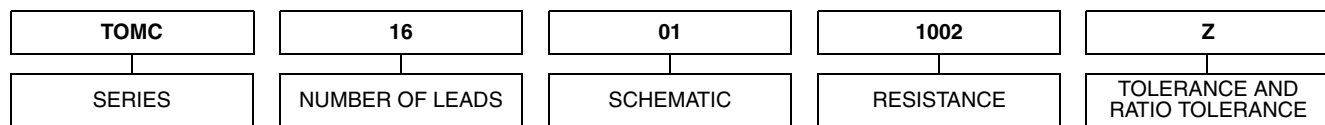



Disclaimer

All product specifications and data are subject to change without notice.

Vishay Intertechnology, Inc., its affiliates, agents, and employees, and all persons acting on its or their behalf (collectively, "Vishay"), disclaim any and all liability for any errors, inaccuracies or incompleteness contained herein or in any other disclosure relating to any product.

Vishay disclaims any and all liability arising out of the use or application of any product described herein or of any information provided herein to the maximum extent permitted by law. The product specifications do not expand or otherwise modify Vishay's terms and conditions of purchase, including but not limited to the warranty expressed therein, which apply to these products.

No license, express or implied, by estoppel or otherwise, to any intellectual property rights is granted by this document or by any conduct of Vishay.

The products shown herein are not designed for use in medical, life-saving, or life-sustaining applications unless otherwise expressly indicated. Customers using or selling Vishay products not expressly indicated for use in such applications do so entirely at their own risk and agree to fully indemnify Vishay for any damages arising or resulting from such use or sale. Please contact authorized Vishay personnel to obtain written terms and conditions regarding products designed for such applications.

Product names and markings noted herein may be trademarks of their respective owners.