

SINGLE 2-INPUT AND GATE

- HIGH SPEED: $t_{PD} = 4.7\text{ns}$ (TYP.) at $V_{CC} = 5\text{V}$
- LOW POWER DISSIPATION:
 $I_{CC} = 1\mu\text{A}$ (MAX.) at $T_A=25^\circ\text{C}$
- COMPATIBLE WITH TTL OUTPUTS:
 $V_{IH} = 2\text{V}$ (MIN), $V_{IL} = 0.8\text{V}$ (MAX)
- POWER DOWN PROTECTION ON INPUTS
- SYMMETRICAL OUTPUT IMPEDANCE:
 $|I_{OH}| = I_{OL} = 8\text{mA}$ (MIN) at $V_{CC} = 4.5\text{V}$
- BALANCED PROPAGATION DELAYS:
 $t_{PLH} \cong t_{PHL}$
- OPERATING VOLTAGE RANGE:
 $V_{CC}(\text{OPR}) = 4.5\text{V}$ to 5.5V
- IMPROVED LATCH-UP IMMUNITY

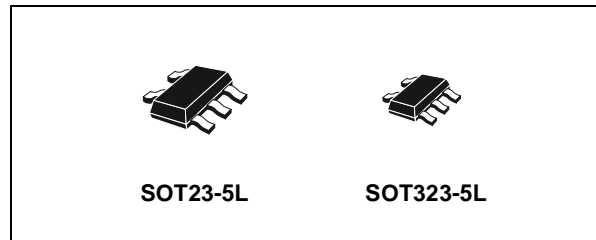

ORDER CODES

PACKAGE	T & R
SOT23-5L	74V1T08STR
SOT323-5L	74V1T08CTR

DESCRIPTION

The 74V1T08 is an advanced high-speed CMOS SINGLE 2-INPUT AND GATE fabricated with sub-micron silicon gate and double-layer metal wiring C²MOS technology. The internal circuit is composed of 2 stages including buffer output, which provide high noise immunity and stable output.

Power down protection is provided on all inputs and 0 to 7V can be accepted on inputs with no regard to the supply voltage. This device can be used to interface 5V to 3V.

PIN CONNECTION AND IEC LOGIC SYMBOLS

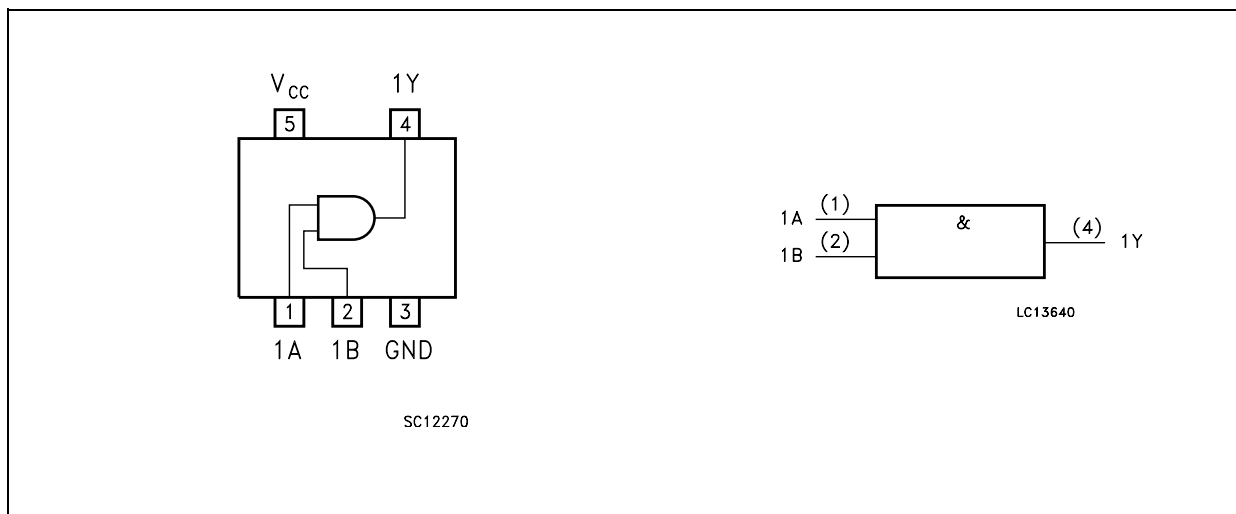

INPUT EQUIVALENT CIRCUIT

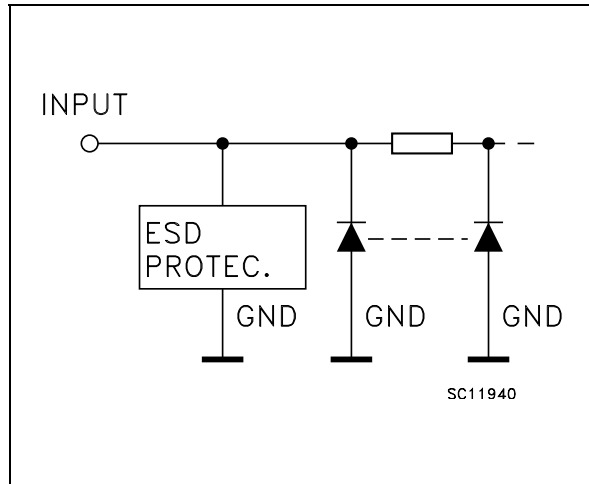

PIN DESCRIPTION

PIN N°	SYMBOL	NAME AND FUNCTION
1	1A	Data Input
2	1B	Data Input
4	1Y	Data Output
3	GND	Ground (0V)
5	V _{CC}	Positive Supply Voltage

TRUTH TABLE

A	B	Y
L	L	L
L	H	L
H	L	L
H	H	H

ABSOLUTE MAXIMUM RATINGS

Symbol	Parameter	Value	Unit
V _{CC}	Supply Voltage	-0.5 to +7.0	V
V _I	DC Input Voltage	-0.5 to +7.0	V
V _O	DC Output Voltage	-0.5 to V _{CC} + 0.5	V
I _{IK}	DC Input Diode Current	- 20	mA
I _{OK}	DC Output Diode Current	± 20	mA
I _O	DC Output Current	± 25	mA
I _{CC} or I _{GND}	DC V _{CC} or Ground Current	± 50	mA
T _{stg}	Storage Temperature	-65 to +150	°C
T _L	Lead Temperature (10 sec)	300	°C

Absolute Maximum Ratings are those values beyond which damage to the device may occur. Functional operation under these conditions is not implied

RECOMMENDED OPERATING CONDITIONS

Symbol	Parameter	Value	Unit
V _{CC}	Supply Voltage	4.5 to 5.5	V
V _I	Input Voltage	0 to 5.5	V
V _O	Output Voltage	0 to V _{CC}	V
T _{op}	Operating Temperature	-55 to 125	°C
dt/dv	Input Rise and Fall Time (note 1) (V _{CC} = 5.0 ± 0.5V)	0 to 20	ns/V

1) V_{IN} from 0.8V to 2V

DC SPECIFICATIONS

Symbol	Parameter	Test Condition		Value						Unit	
		V _{CC} (V)		T _A = 25°C			-40 to 85°C		-55 to 125°C		
				Min.	Typ.	Max.	Min.	Max.	Min.		Max.
V _{IH}	High Level Input Voltage	4.5 to 5.5		2			2		2		V
V _{IL}	Low Level Input Voltage	4.5 to 5.5				0.8		0.8		0.8	V
V _{OH}	High Level Output Voltage	4.5	I _O =-50 μA	4.4	4.5		4.4		4.4		V
		4.5	I _O =-8 mA	3.94			3.8		3.7		
V _{OL}	Low Level Output Voltage	4.5	I _O =50 μA		0.0	0.1		0.1		0.1	V
		4.5	I _O =8 mA			0.36		0.44		0.55	
I _I	Input Leakage Current	0 to 5.5	V _I = 5.5V or GND			± 0.1		± 1.0		± 1.0	μA
I _{CC}	Quiescent Supply Current	5.5	V _I = V _{CC} or GND			1		10		20	μA
+I _{CC}	Additional Worst Case Supply Current	5.5	One Input at 3.4V, other input at V _{CC} or GND			1.35		1.5		1.5	mA

AC ELECTRICAL CHARACTERISTICS (Input t_r = t_f = 3ns)

Symbol	Parameter	Test Condition		Value						Unit	
		V _{CC} (V)	C _L (pF)	T _A = 25°C			-40 to 85°C		-55 to 125°C		
				Min.	Typ.	Max.	Min.	Max.	Min.		Max.
t _{PLH}	Propagation Delay Time	5.0 (*)	15		3.9	6.7	1.0	7.5	1.0	8.5	ns
t _{PHL}		5.0 (*)	50		4.5	7.7	1.0	8.5	1.0	9.5	

(*) Voltage range is 5.0V ± 0.5V

CAPACITIVE CHARACTERISTICS

Symbol	Parameter	Test Condition		Value						Unit	
				T _A = 25°C			-40 to 85°C		-55 to 125°C		
				Min.	Typ.	Max.	Min.	Max.	Min.		Max.
C _{IN}	Input Capacitance				4	10		10		10	pF
C _{PD}	Power Dissipation Capacitance (note 1)				14						pF

1) C_{PD} is defined as the value of the IC's internal equivalent capacitance which is calculated from the operating current consumption without load. (Refer to Test Circuit). Average operating current can be obtained by the following equation. I_{CC(oper)} = C_{PD} × V_{CC} × f_{IN} + I_{CC}

TEST CIRCUIT



$C_L = 15/50\text{pF}$ or equivalent (includes jig and probe capacitance)
 $R_T = Z_{OUT}$ of pulse generator (typically 50Ω)

WAVEFORM: PROPAGATION DELAY ($f=1\text{MHz}$; 50% duty cycle)

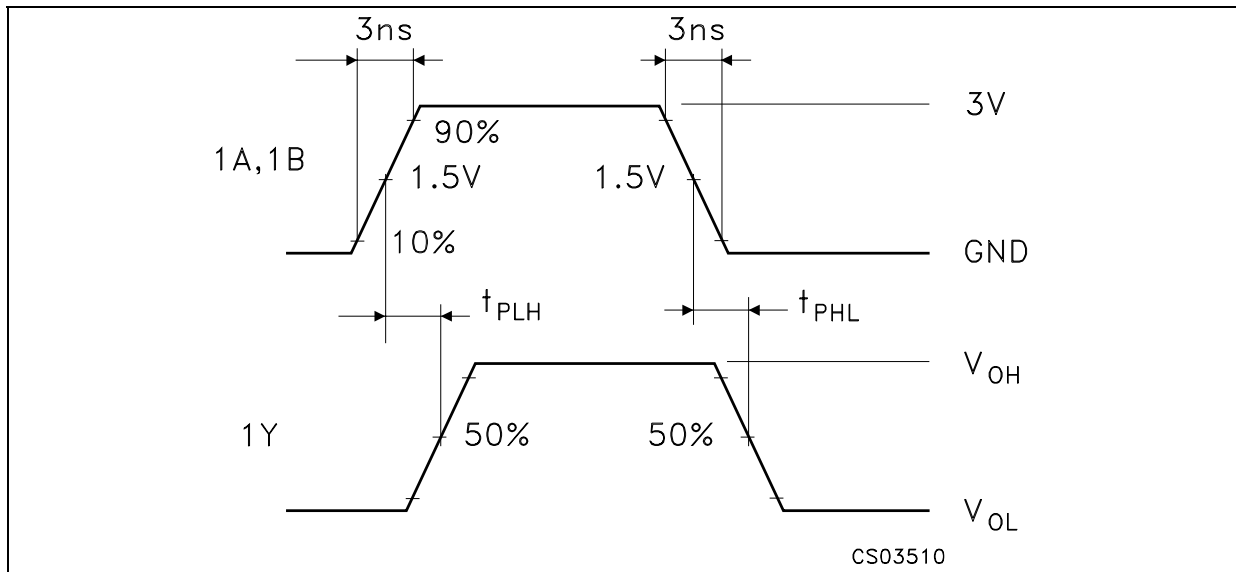

SOT23-5L MECHANICAL DATA

DIM.	mm.			mils		
	MIN.	TYP	MAX.	MIN.	TYP.	MAX.
A	0.90		1.45	35.4		57.1
A1	0.00		0.10	0.0		3.9
A2	0.90		1.30	35.4		51.2
b	0.35		0.50	13.7		19.7
C	0.09		0.20	3.5		7.8
D	2.80		3.00	110.2		118.1
E	1.50		1.75	59.0		68.8
e		0.95			37.4	
H	2.60		3.00	102.3		118.1
L	0.10		0.60	3.9		23.6



SOT323-5L MECHANICAL DATA

DIM.	mm.			mils		
	MIN.	TYP	MAX.	MIN.	TYP.	MAX.
A	0.80		1.10	31.5		43.3
A1	0.00		0.10	0.0		3.9
A2	0.80		1.00	31.5		39.4
b	0.15		0.30	5.9		11.8
C	0.10		0.18	3.9		7.1
D	1.80		2.20	70.9		86.6
E	1.80		2.40	70.9		94.5
E1	1.15		1.35	45.3		53.1
e		0.65			25.6	
e1		1.3			51.2	
L	0.10		0.30	3.9		11.8

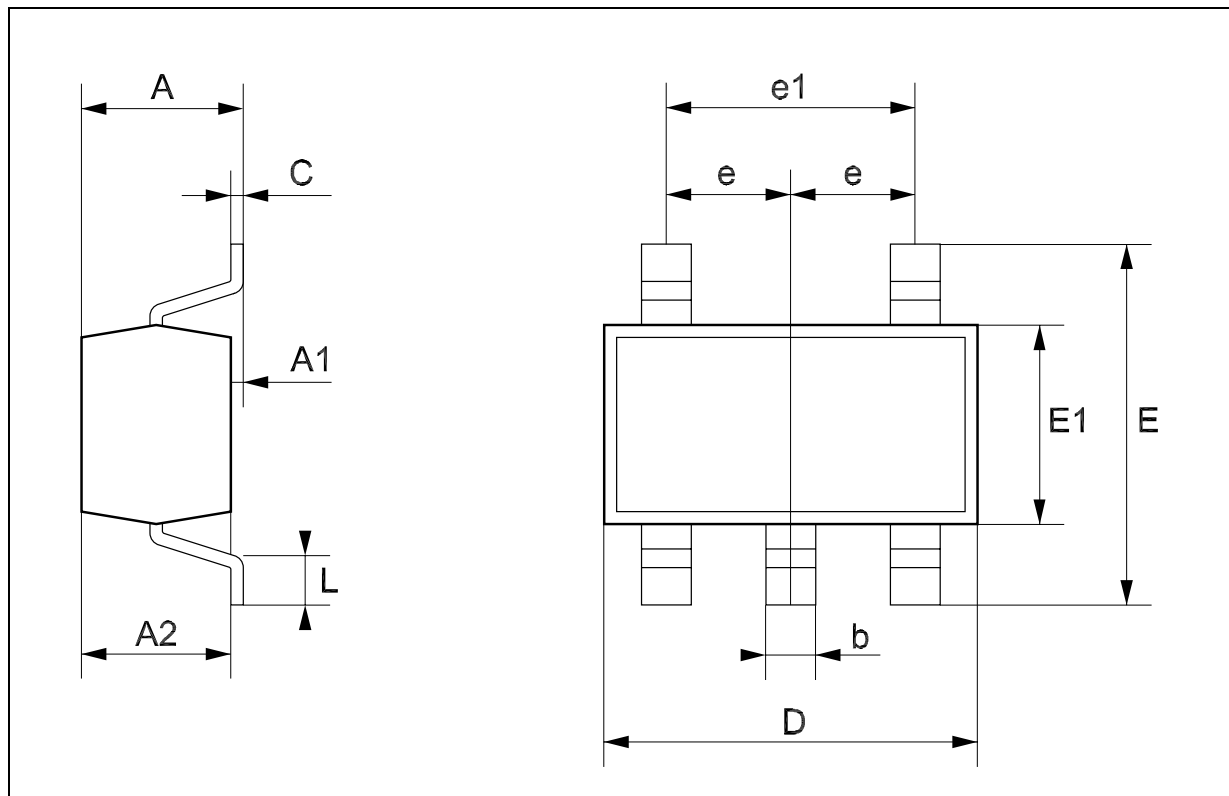

Tape & Reel SOT23-xL MECHANICAL DATA

DIM.	mm.			inch		
	MIN.	TYP	MAX.	MIN.	TYP.	MAX.
A			180			7.086
C	12.8	13.0	13.2	0.504	0.512	0.519
D	20.2			0.795		
N	60			2.362		
T			14.4			0.567
Ao	3.13	3.23	3.33	0.123	0.127	0.131
Bo	3.07	3.17	3.27	0.120	0.124	0.128
Ko	1.27	1.37	1.47	0.050	0.054	0.058
Po	3.9	4.0	4.1	0.153	0.157	0.161
P	3.9	4.0	4.1	0.153	0.157	0.161

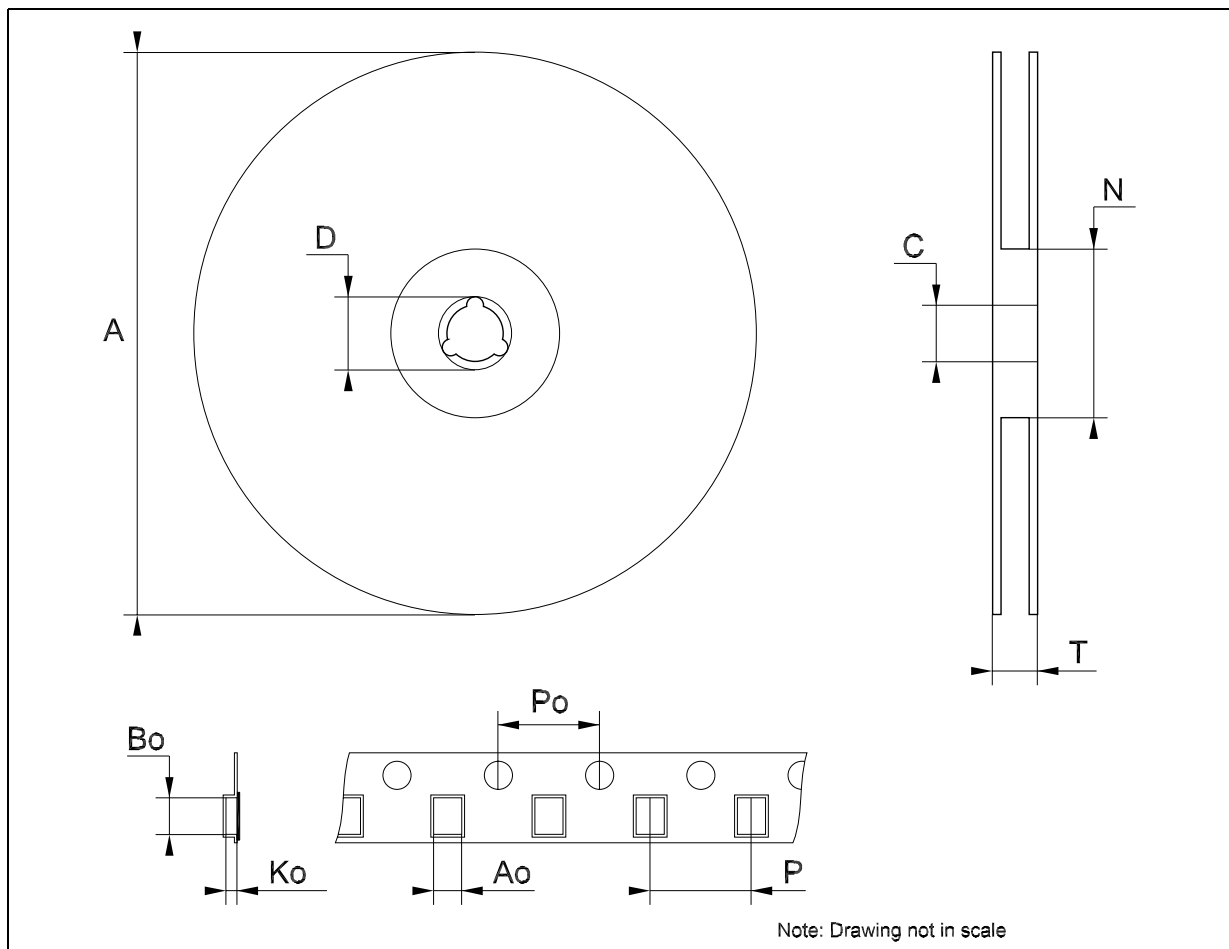

Tape & Reel SOT323-xL MECHANICAL DATA

DIM.	mm.			inch		
	MIN.	TYP	MAX.	MIN.	TYP.	MAX.
A	175	180	185	6.889	7.086	7.283
C	12.8	13	13.2	0.504	0.512	0.519
D	20.2			0.795		
N	59.5	60	60.5		2.362	
T			14.4			0.567
Ao		2.25			0.088	
Bo		2.7			0.106	
Ko		1.2			0.047	
Po	3.9	4	4.1	0.153	0.157	0.161
P	3.8	4	4.2	0.149	0.157	0.165

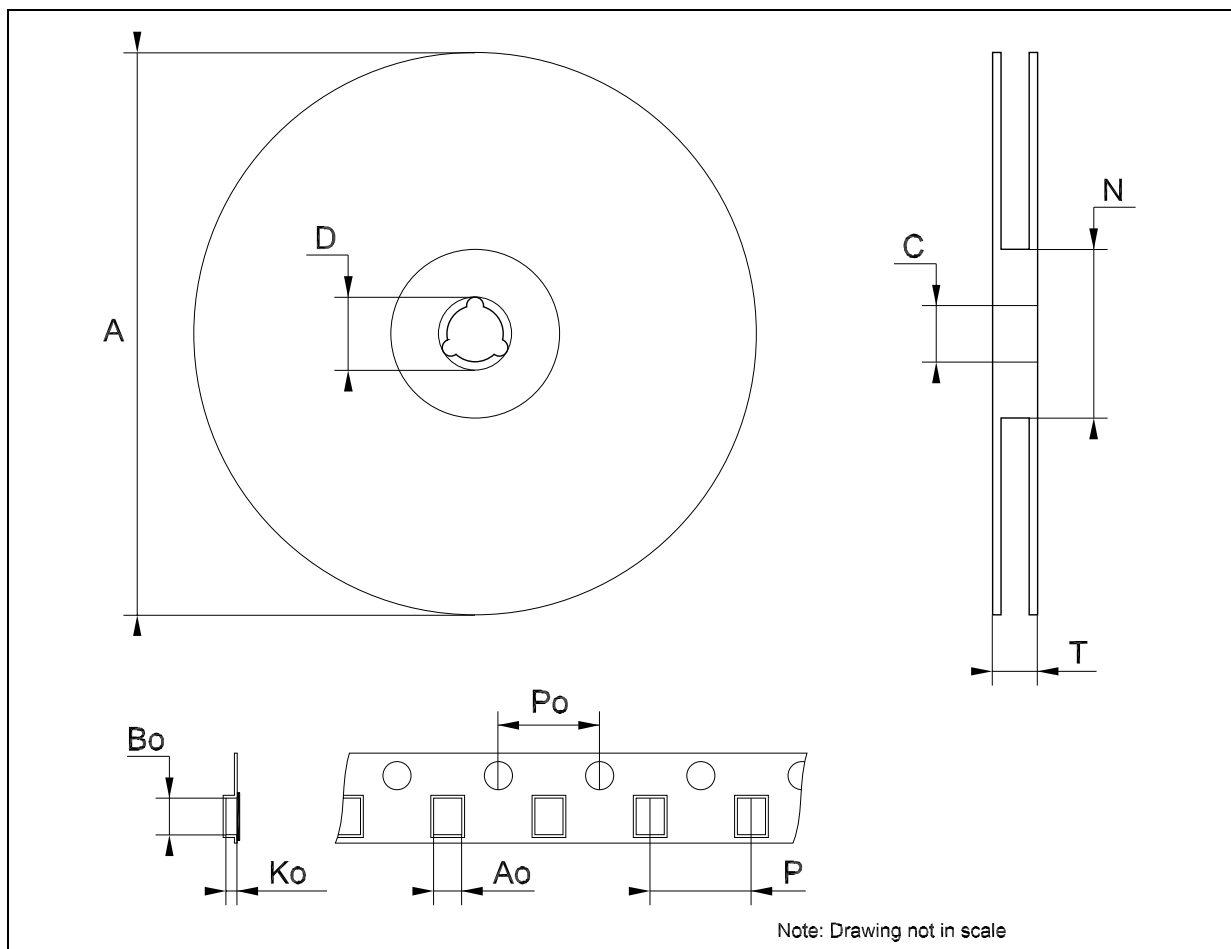

Information furnished is believed to be accurate and reliable. However, STMicroelectronics assumes no responsibility for the consequences of use of such information nor for any infringement of patents or other rights of third parties which may result from its use. No license is granted by implication or otherwise under any patent or patent rights of STMicroelectronics. Specifications mentioned in this publication are subject to change without notice. This publication supersedes and replaces all information previously supplied. STMicroelectronics products are not authorized for use as critical components in life support devices or systems without express written approval of STMicroelectronics.

The ST logo is a registered trademark of STMicroelectronics
All other names are the property of their respective owners

© 2004 STMicroelectronics - All Rights Reserved
STMicroelectronics GROUP OF COMPANIES

Australia - Belgium - Brazil - Canada - China - Czech Republic - Finland - France - Germany - Hong Kong - India - Israel - Italy - Japan -
Malaysia - Malta - Morocco - Singapore - Spain - Sweden - Switzerland - United Kingdom - United States.

<http://www.st.com>