

Ku-Band VSAT Packaged Amplifier

TGA2508-EPU-SM



Top View

Bottom View

Key Features

- Typical Frequency Range: 12 - 19 GHz
- 25 dB Nominal Gain
- 29 dBm Nominal P1dB
- Bias Conditions: 7 V, 433 mA
- PHEMT Technology
- Low cost true surface mount package
- Package Dimensions:
4.0 x 4.0 x 0.9 mm
(0.157 x 0.157 x 0.035 in)

Preliminary Measured Data

Bias Conditions: $V_d = 7\text{ V}$, $I_d = 433\text{ mA}$

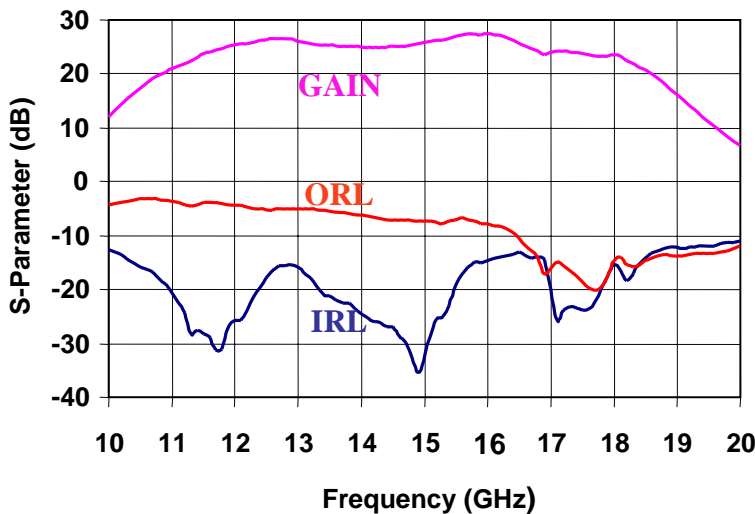

Primary Applications

- VSAT Ground Terminals
- Point to Point Radio
- Military Ku Band
- Ku-Band Space

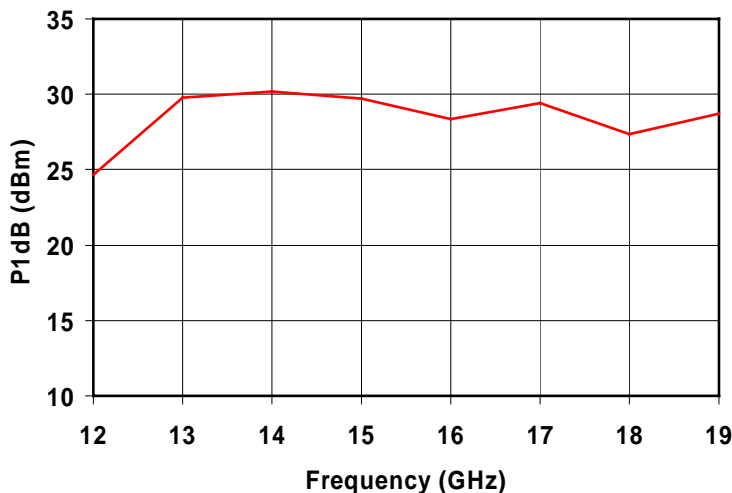

Note: Devices designated as EPU are typically early in their characterization process prior to finalizing all electrical and process specifications. Specifications are subject to change without notice

TABLE I
MAXIMUM RATINGS 5/

SYMBOL	PARAMETER	VALUE	NOTES
V ⁺	Positive Supply Voltage	8 V	<u>4/</u>
V ⁻	Negative Supply Voltage Range	-2 to 0 V	
I ⁺	Positive Supply Current (Quiescent)	591 mA	<u>4/</u>
I _G	Gate Supply Current	16 mA	
P _{IN}	Input Continuous Wave Power	17 dBm	
P _D	Power Dissipation	4.7 W	<u>3/ 4/</u>
T _{CH}	Operating Channel Temperature	150 °C	<u>1/ 2/</u>
T _M	Mounting Temperature (30 Seconds)	250 °C	
T _{STG}	Storage Temperature	-65 to 150 °C	
T _{CASE}	Package Operating Temperature	-40 to 110 °C	

- 1/ These ratings apply to each individual FET.
- 2/ Junction operating temperature will directly affect the device median time to failure (T_M). For maximum life, it is recommended that junction temperatures be maintained at the lowest possible levels.
- 3/ When operated at this bias condition with a base plate temperature of 70 °C, the median life is 4.3E+6 hrs.
- 4/ Combinations of supply voltage, supply current, input power, and output power shall not exceed P_D.
- 5/ These ratings represent the maximum operable values for this device.

Note: Devices designated as EPU are typically early in their characterization process prior to finalizing all electrical and process specifications. Specifications are subject to change without notice

TABLE II
ELECTRICAL CHARACTERISTICS

(Ta = 25°C ± 5°C)

PARAMETER	TYPICAL	UNITS
Frequency Range	12 - 19	GHz
Drain Operating	7	V
Quiescent Current	433	mA
Small Signal Gain	25	dB
Input Return Loss (Linear Small Signal)	15	dB
Output Return Loss (Linear Small Signal)	7	dB
Output Power @ 1 dB Compression Gain	29	dBm

TABLE III
THERMAL INFORMATION

PARAMETER	TEST CONDITIONS	T _{CH} (°C)	R _{θJC} (°C/W)	T _M (HRS)
R _{θJC} Thermal Resistance (Channel to Case)	Vd = 7 V I _D = 433 mA Pdiss = 3.031 W	111	13.5	3.8 E+7

Note: Worst case condition with no RF applied, 100% of DC power is dissipated, Case Temperature @ 70 °C

Preliminary Measured Data

Bias Conditions: $V_d = 5 - 7 \text{ V}$, $I_d = 433 \text{ mA}$

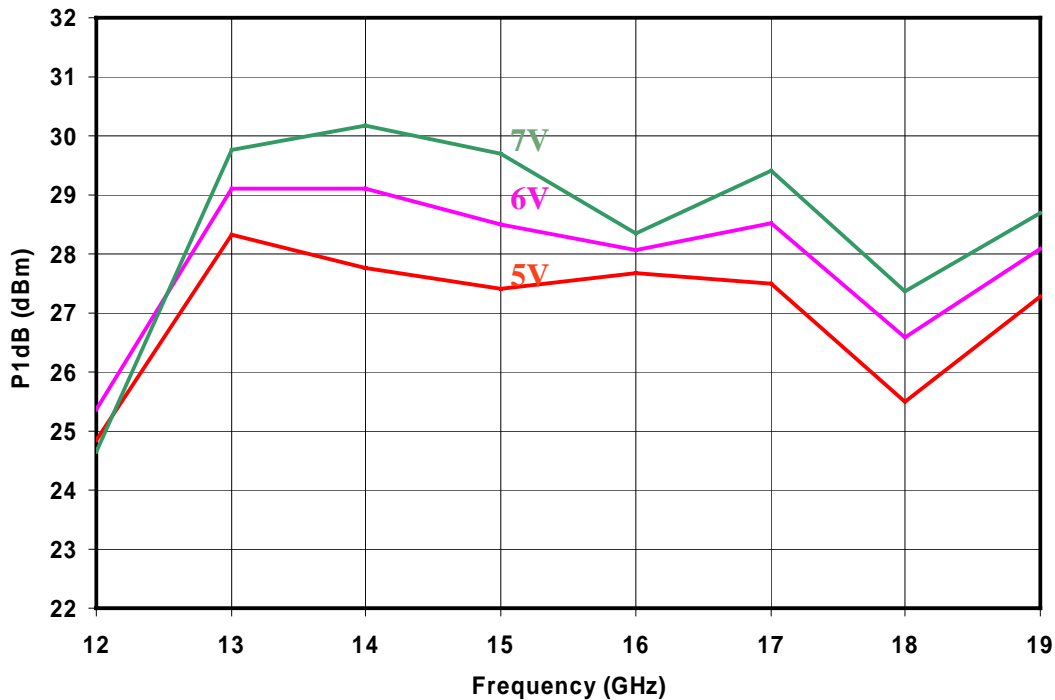
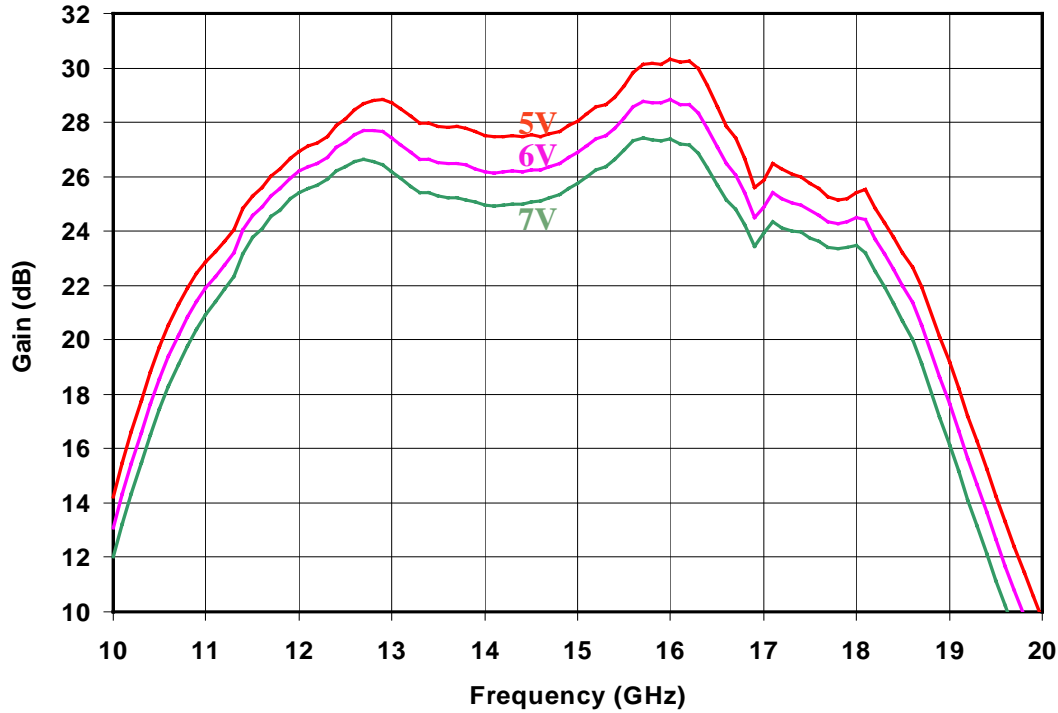

Note: Devices designated as EPU are typically early in their characterization process prior to finalizing all electrical and process specifications. Specifications are subject to change without notice

Preliminary Measured Data

Bias Conditions: $V_d = 5 - 7 \text{ V}$, $I_d = 433 \text{ mA}$

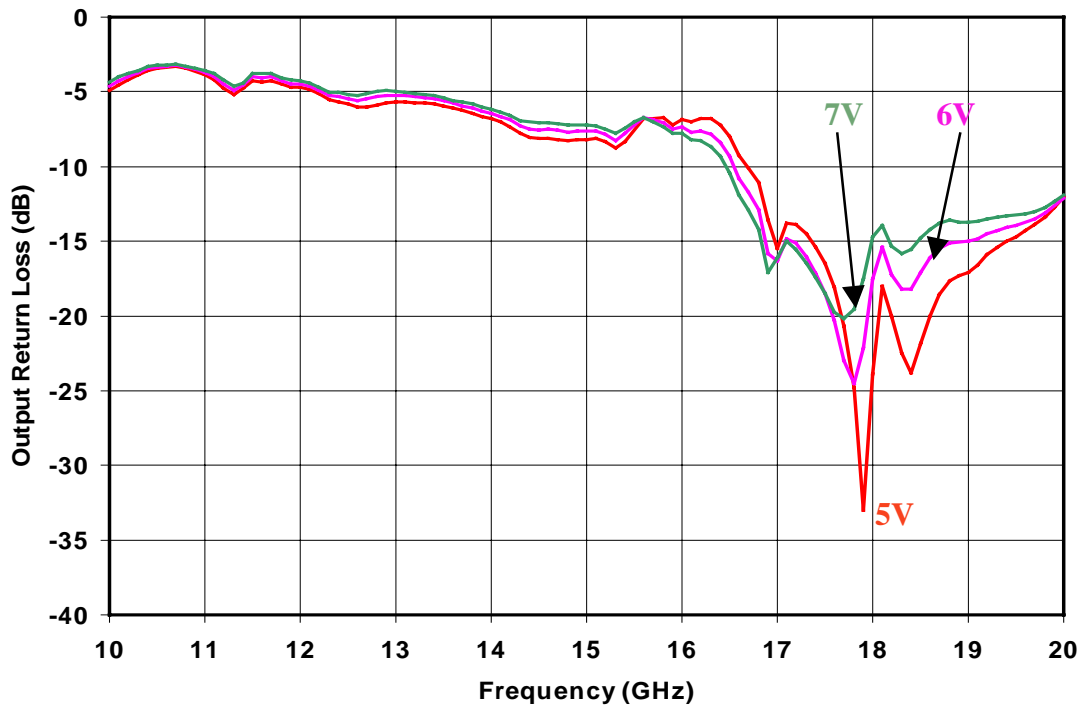
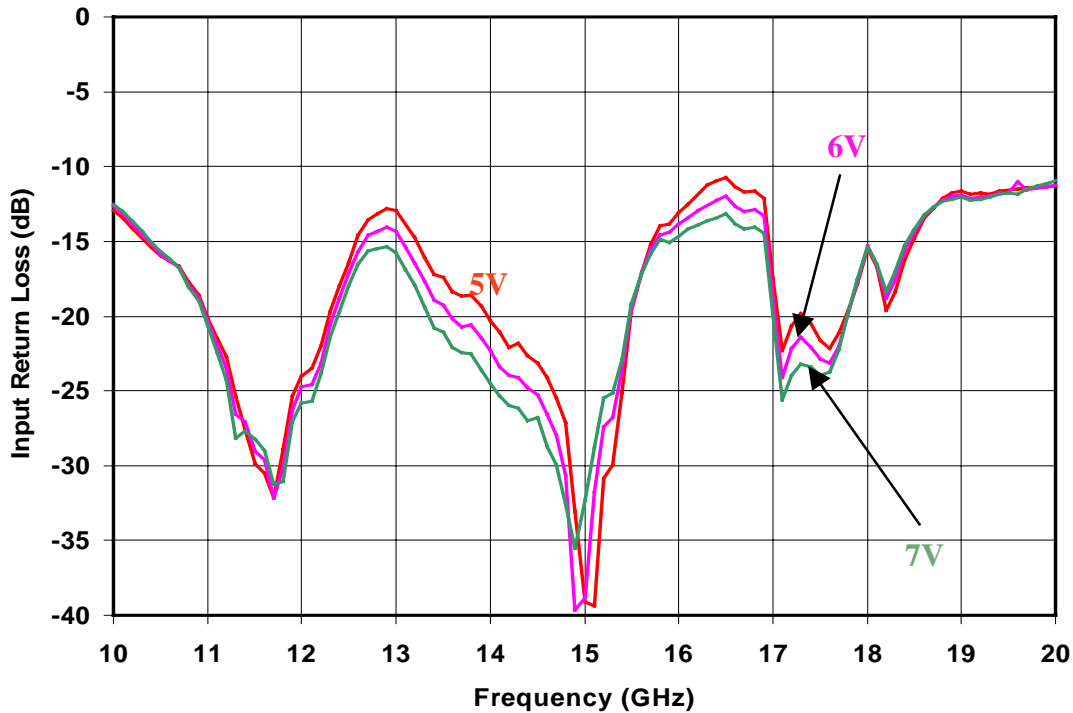

Note: Devices designated as EPU are typically early in their characterization process prior to finalizing all electrical and process specifications. Specifications are subject to change without notice

Preliminary Measured Data

Bias Conditions: $V_d = 5 - 7 \text{ V}$, $I_d = 433 \text{ mA}$

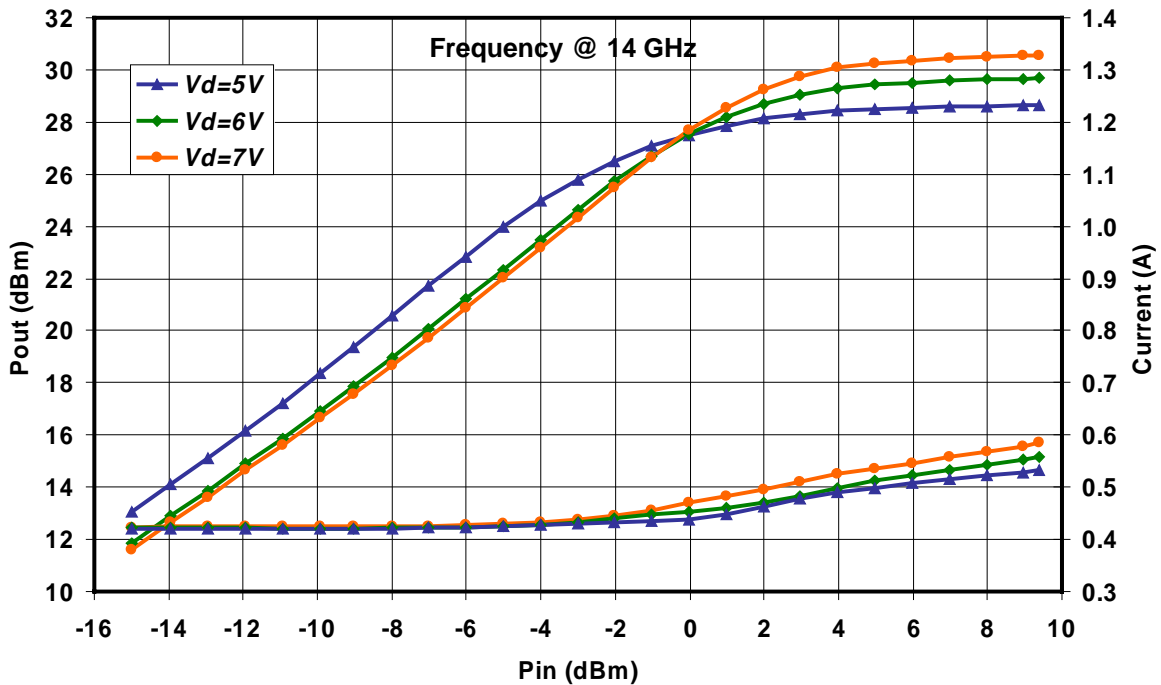
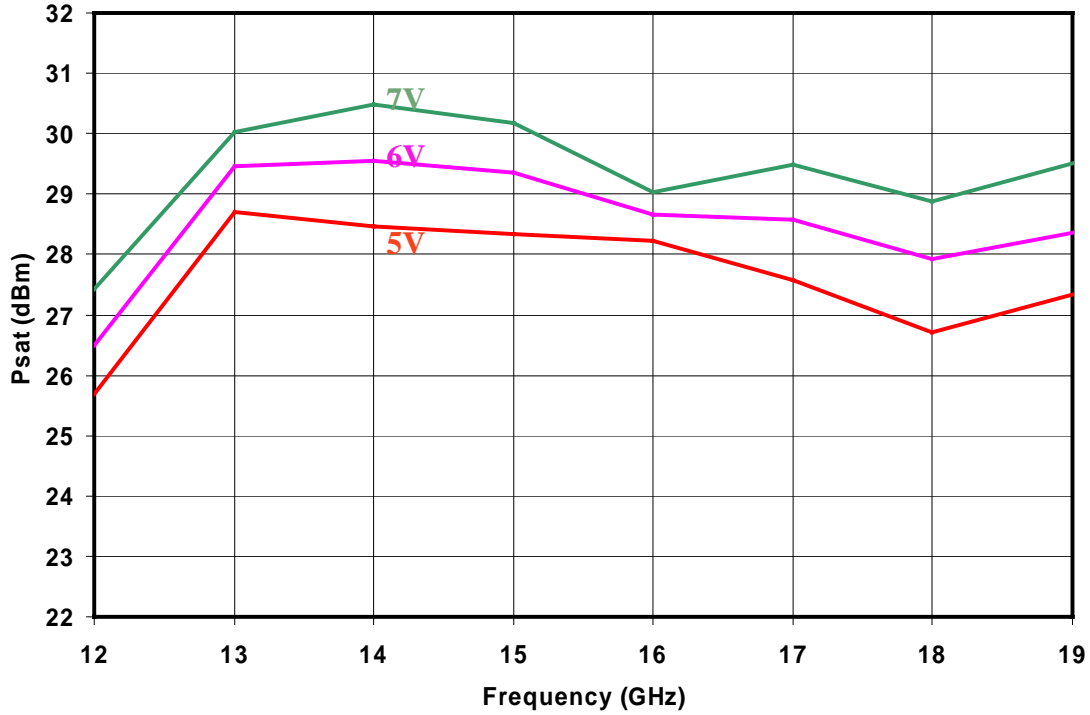

Note: Devices designated as EPU are typically early in their characterization process prior to finalizing all electrical and process specifications. Specifications are subject to change without notice

Package Layout

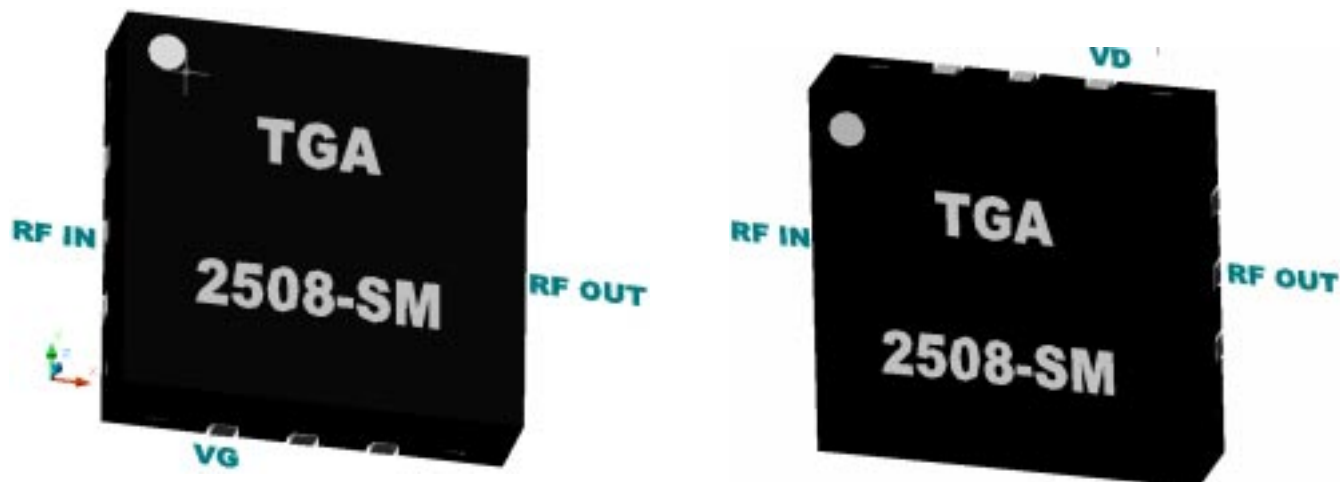

Top View

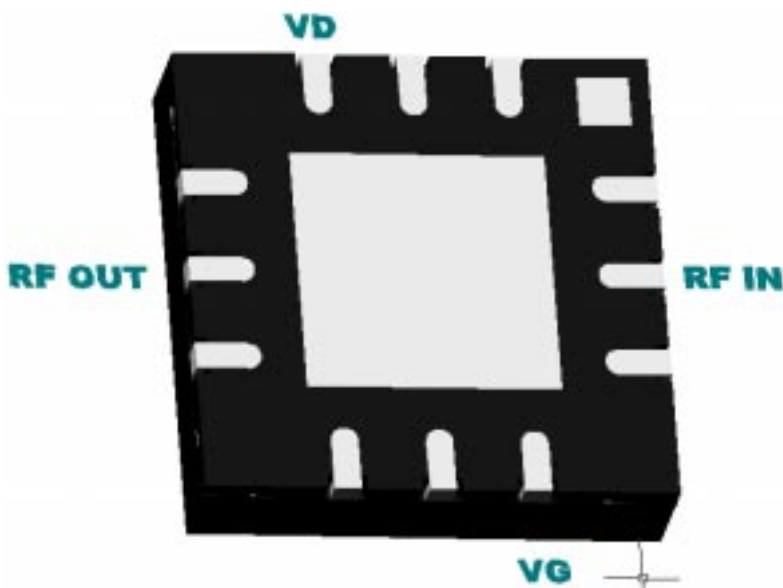

Bottom View

GaAs MMIC devices are susceptible to damage from Electrostatic Discharge. Proper precautions should be observed during handling, assembly and test.

Note: Devices designated as EPU are typically early in their characterization process prior to finalizing all electrical and process specifications. Specifications are subject to change without notice

Package Pinout Diagram

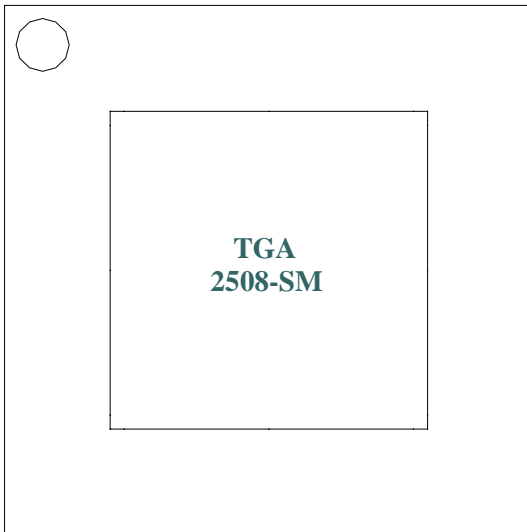

Top Side

Dot indicates Pin 1

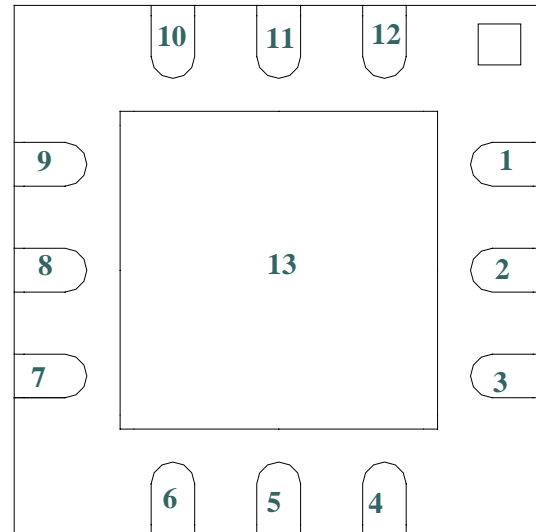

Bottom Side

Pin	Description
1	NC
2	RF Input
3	NC
4	Vg
5 - 7	NC
8	RF Output
9	NC
10	Vd
11, 12	NC
13	GND

Note: Devices designated as EPU are typically early in their characterization process prior to finalizing all electrical and process specifications. Specifications are subject to change without notice

**Mechanical Drawing
(Bottom Side)**

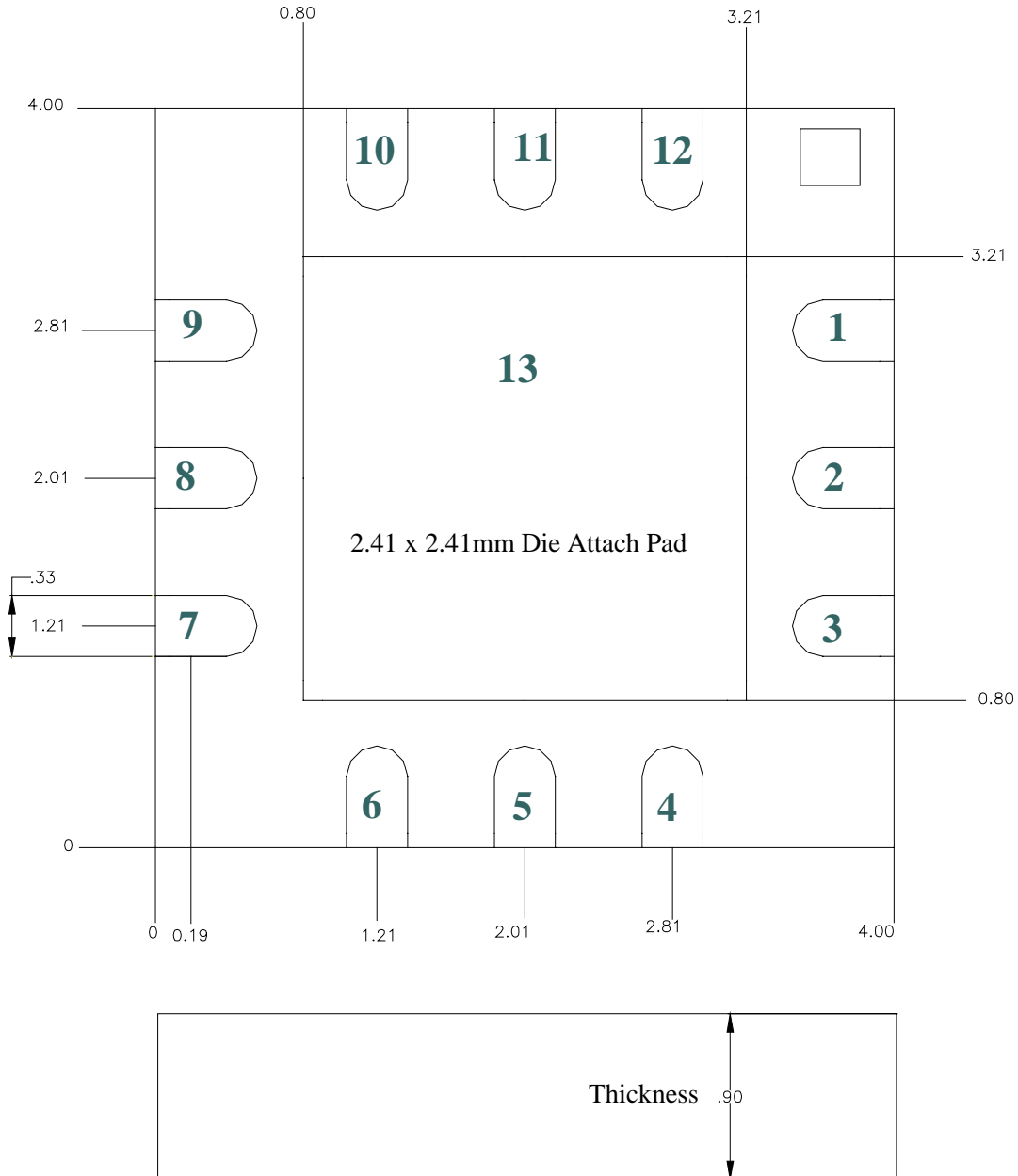

Units: Millimeters

Package tolerance: +/- 0.10

GaAs MMIC devices are susceptible to damage from Electrostatic Discharge. Proper precautions should be observed during handling, assembly and test.

Note: Devices designated as EPU are typically early in their characterization process prior to finalizing all electrical and process specifications. Specifications are subject to change without notice

Recommended Board Layout Assembly

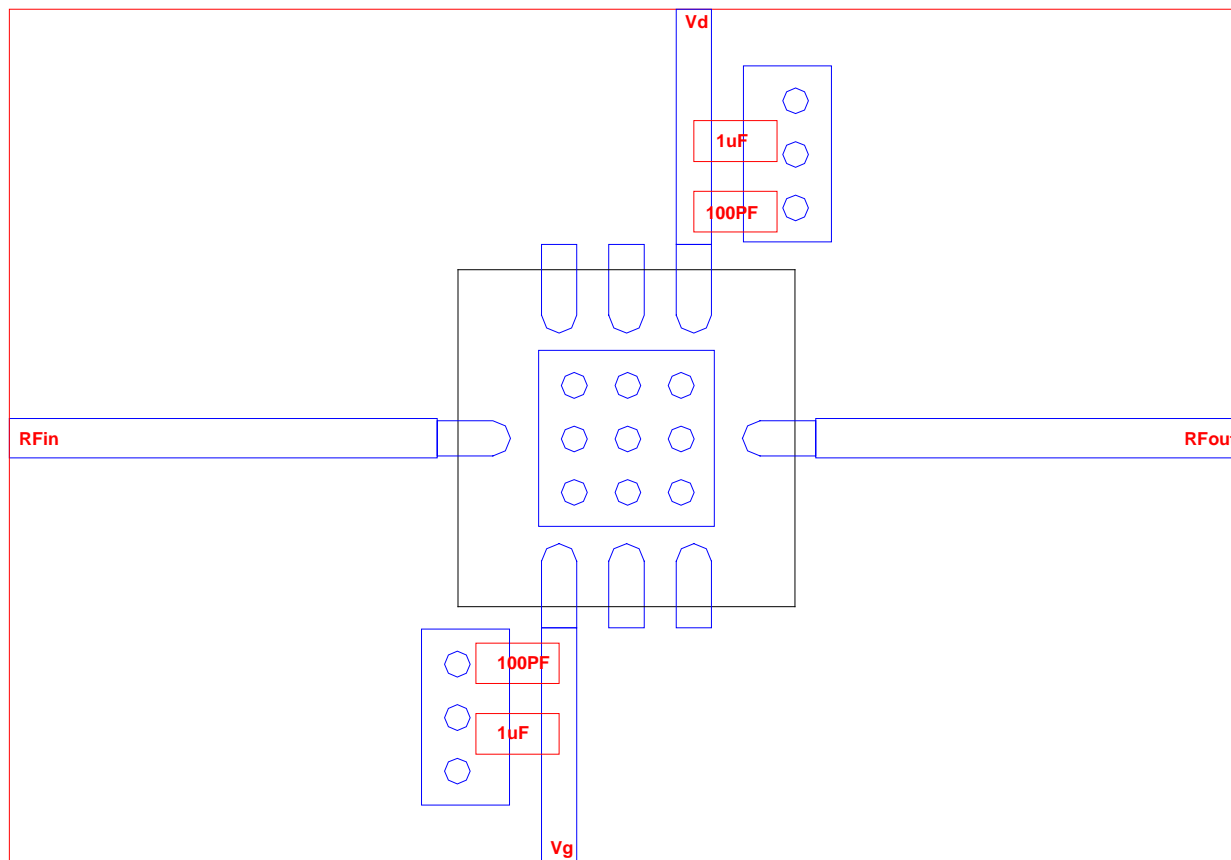

All measurement was made with part solder to 0.008 in thick of RO4003

Note: Devices designated as EPU are typically early in their characterization process prior to finalizing all electrical and process specifications. Specifications are subject to change without notice