

SP4020 Series 2.5pF, 30A Discrete TVS Diode



Pinout



Functional Block Diagram

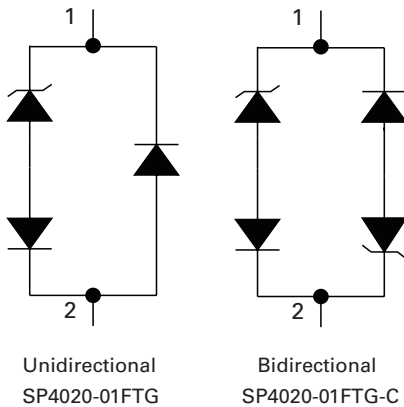

Description

The SP4020 devices integrate low capacitance steering diodes with one or two zener diodes for unidirectional or bidirectional protection, respectively, to protect against ESD and lightning induced surge events. These devices can safely absorb up to 30A per IEC61000-4-5 ($t_p=8/20\mu s$) without performance degradation and a minimum $\pm 30kV$ ESD per IEC61000-4-2 International Standard. The low loading capacitance and high surge capability make it ideal for protecting telecommunication ports such as Ethernet and other high speed data interfaces.

Features

- ESD, IEC61000-4-2, $\pm 30kV$ contact, $\pm 30kV$ air
- EFT, IEC61000-4-4, 40A (5/50ns)
- Lightning, IEC61000-4-5, 30A ($t_p=8/20\mu s$)
- Low capacitance of 2.5pF (@ $V_R=0V$)
- Low leakage current of $0.1\mu A$ at 3.3V
- Unidirectional and Bidirectional configuration
- Small SOD323 package fits 0805 footprints

Applications

- 10/100/1000 Ethernet
- T1/E1/T3/E3
- USB 1.1/2.0
- Power Ports
- Computers and Peripherals
- Instrumentation
- Medical Equipment

Life Support Note:

Not Intended for Use in Life Support or Life Saving Applications

The products shown herein are not designed for use in life sustaining or life saving applications unless otherwise expressly indicated.

Absolute Maximum Ratings

Symbol	Parameter	Value	Units
I_{PP}	Peak Current ($t_p=8/20\mu s$)	30	A
P_{PK}	Peak Pulse Power ($t_p=8/20\mu s$)	750	W
T_{OP}	Operating Temperature	-40 to 125	°C
T_{STOR}	Storage Temperature	-55 to 150	°C

Notes:
CAUTION: Stresses above those listed in "Absolute Maximum Ratings" may cause permanent damage to the device. This is a stress only rating and operation of the device at these or any other conditions above those indicated in the operational sections of this specification is not implied.

Thermal Information

Parameter	Rating	Units
Storage Temperature Range	-55 to 150	°C
Maximum Junction Temperature	150	°C
Maximum Lead Temperature (Soldering 20-40s)	260	°C

Electrical Characteristics ($T_{OP}=25^\circ C$)

Parameter	Symbol	Test Conditions	Min	Typ	Max	Units
Breakdown Voltage	V_{BD}	$I_R=2\mu A$	3.5			V
Reverse Standoff Voltage	V_{RWM}	$I_R \leq 1\mu A$			3.3	V
Leakage Current	I_{LEAK}	$V_R=3.3V$		0.1	0.5	μA
Clamp Voltage ¹	V_C	$I_{PP}=1A, t_p=8/20\mu s, Fwd$		6.6		V
		$I_{PP}=10A, t_p=8/20\mu s, Fwd$		14.2		V
		$I_{PP}=24A, t_p=8/20\mu s, Fwd$		21.8		V
Dynamic Resistance	R_{DYN}	$(V_{C2} - V_{C1}) / (I_{PP2} - I_{PP1})$		0.7		Ω
ESD Withstand Voltage ¹	V_{ESD}	IEC61000-4-2 (Contact Discharge)	± 30			kV
		IEC61000-4-2 (Air Discharge)	± 30			kV
Diode Capacitance ¹	C_D	Reverse Bias=0V, f=1MHz		2.5		pF

Note:
¹Parameter is guaranteed by design and/or device characterization.

Normalized Capacitance vs. Bias Voltage

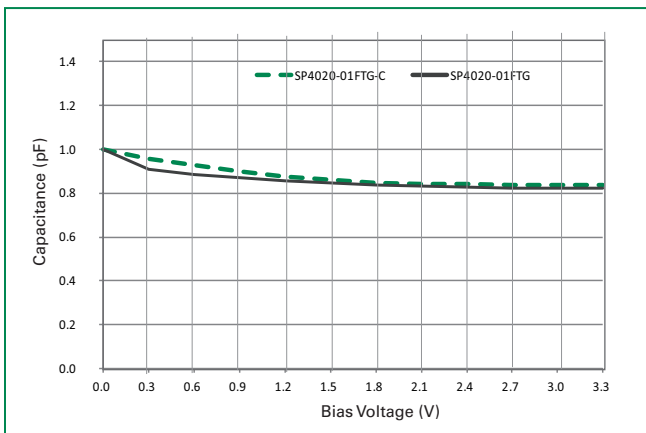

Non-Repetitive Peak Pulse Power vs. Pulse Time

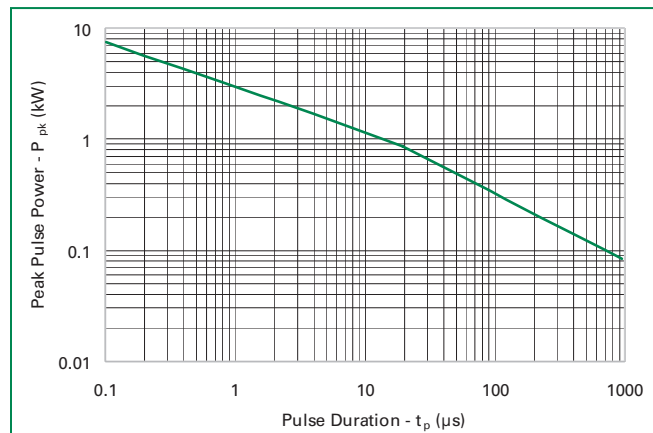

Clamping Voltage vs. I_{pp}

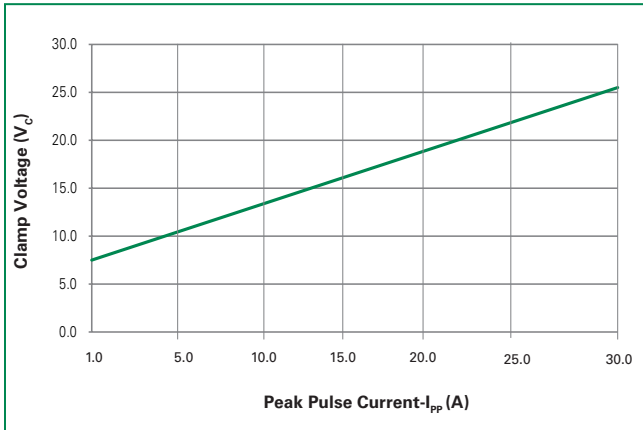

Pulse Waveform

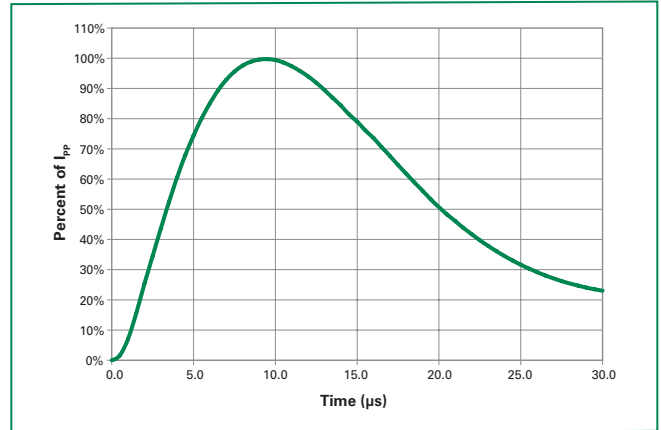

Soldering Parameters

Reflow Condition	Pb – Free assembly	
Pre Heat	- Temperature Min ($T_{s(min)}$)	150°C
	- Temperature Max ($T_{s(max)}$)	200°C
	- Time (min to max) (t_s)	60 – 180 secs
Average ramp up rate (Liquidus) Temp (T_L) to peak		3°C/second max
$T_{s(max)}$ to T_L - Ramp-up Rate		3°C/second max
Reflow	- Temperature (T_L) (Liquidus)	217°C
	- Temperature (t_L)	60 – 150 seconds
Peak Temperature (T_p)		260 ^{+0/-5} °C
Time within 5°C of actual peak Temperature (t_p)		20 – 40 seconds
Ramp-down Rate		6°C/second max
Time 25°C to peak Temperature (T_p)		8 minutes Max.
Do not exceed		260°C

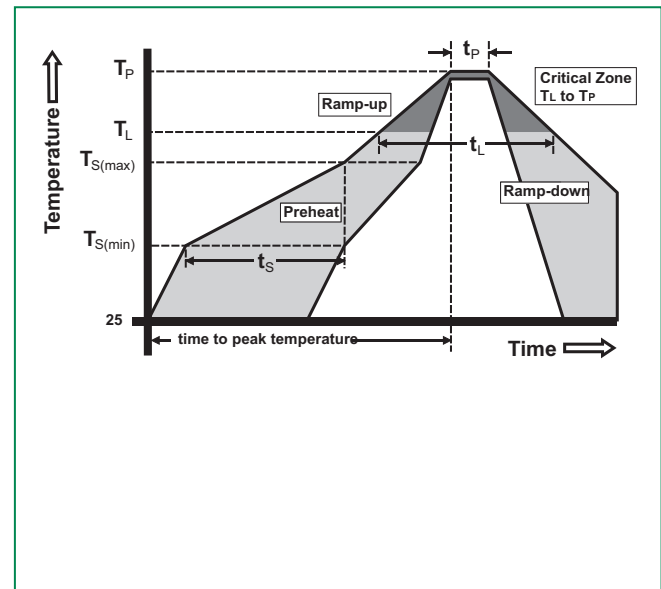

Product Characteristics

Lead Plating	Matte Tin
Lead Material	Copper Alloy
Lead Coplanarity	0.0004 inches (0.102mm)
Substitute Material	Silicon
Body Material	Molded Epoxy
Flammability	UL 94 V-0

- Notes :
1. All dimensions are in millimeters
 2. Dimensions include solder plating.
 3. Dimensions are exclusive of mold flash & metal burr.
 4. Blo is facing up for mold and facing down for trim/form, i.e. reverse trim/form.
 5. Package surface matte finish VDI 11-13.

Part Marking System

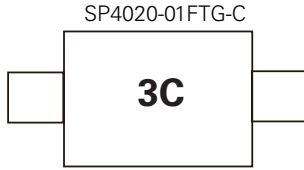
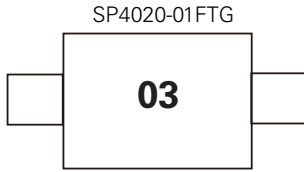

Part Numbering System

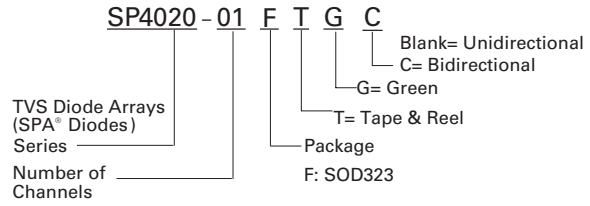

Ordering Information

Part Number	Package	Marking	Min. Order Qty.
SP4020-01FTG	SOD323	03	3000
SP4020-01FTG-C	SOD323	3C	3000

Package Dimensions -SOD323

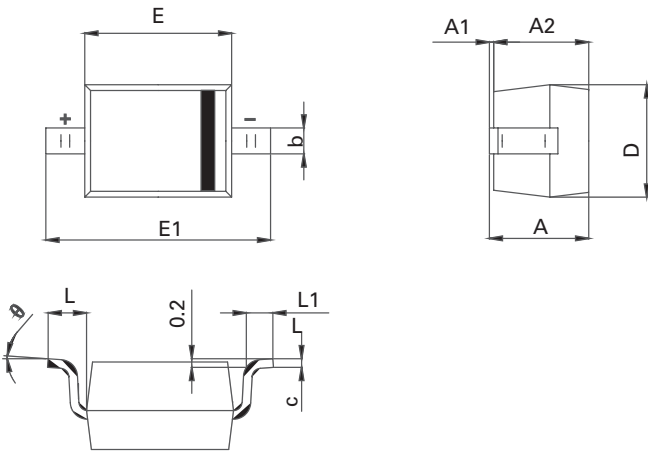

Symbol	SOD323			
	Millimeters		Inches	
	Min	Max	Min	Max
A		1.00		0.039
A1	0.00	0.10	0.000	0.004
A2	0.80	0.90	0.031	0.035
b	0.25	0.35	0.010	0.014
c	0.08	0.15	0.003	0.006
D	1.20	1.40	0.047	0.055
E	1.60	1.80	0.063	0.071
E1	2.50	2.70	0.098	0.106
L	0.475 REF		0.019 REF	
L1	0.25	0.40	0.010	0.016
Ø	0°	8°	0°	8°

Embossed Carrier Tape & Reel Specification – SOD323

