

FEB227 User's Guide

Universal Input 12W LED Ballast

Featured Fairchild Product: FAN102MY

Table of Contents

1.0 General Board Description	4
1.1 Contents of the Evaluation Kit	4
1.2 Power Supply Specification Table	4
2.0 Circuit Description	5
2.1 Board Photograph	5
2.2 Schematic	7
2.3 PCB Layout	9
2.4 Evaluation Board Connection	10
3.0 Test Equipment	11
4.0 Test Results	12
4.1 Standby Power vs Input Voltage ($I_{out(max)} = 350mA$)	12
4.2 Full Load Efficiency vs Input Voltage ($I_{out(max)} = 350mA$)	14
4.3 Line Regulation ($I_{out(max)} = 350mA$)	15
4.4 Load Regulation ($I_{out(max)} = 350mA$)	16
4.5 Standby Power vs Input Voltage ($I_{out(max)} = 700mA$)	18
4.6 Full Load Efficiency vs Input Voltage ($I_{out(max)} = 700mA$)	20
4.7 Line Regulation ($I_{out(max)} = 700mA$)	21
4.8 Load Regulation ($I_{out(max)} = 700mA$)	22
4.9 Output Ripple & Noise	24
4.10 Soft Start Test	26
4.11 Output Short Circuit Protection Test	28
4.12 Typical Drain Waveforms	30
4.13 Thermal Performance	34
4.14 EMI Tests	36
5.0 Bill of Materials and Transformer Specification	38
5.1 Bill of Materials	38

5.2 Transformer Specification	39
6.0 Printed Circuit Board Special Instructions	40
7.0 Featured Products	42
7.1 FAN102 Description	42
7.1.1 FAN102 Features	42
7.1.2 FAN102 Block Diagram	43
8.0 References and Resources	44
8.1 Application Notes	44

**Direct questions or comments about this Evaluation Board to:
“Worldwide Direct Support”**

Fairchild Semiconductor.com

Disclaimer

Fairchild Semiconductor Limited (“Fairchild”) provides these design services as a benefit to our customers. Fairchild has made a good faith attempt to build for the specifications provided or needed by the customer. Fairchild provides this product “as is” and without “recourse” and **MAKES NO WARRANTY, EXPRESSED, IMPLIED OR OTHERWISE, INCLUDING ANY WARRANTY OF MERCHANTABILITY AND FITNESS FOR A PARTICULAR PURPOSE.**

Customer agrees to do its own testing of any Fairchild design in order to ensure design meets the customer needs. Neither Fairchild nor Customer shall be liable for incidental or consequential damages, including but not limited to, the cost of labor, re-qualifications, rework charges, delay, lost profits, or loss of goodwill arising out of the sale, installation or use of any Fairchild product.

Fairchild will defend any suit or proceeding brought against Customer if it is based on a claim that any of its products infringes any U.S., Canadian, Japanese, EU or EFTA member country intellectual property right. Fairchild must be notified promptly in writing and given full and complete authority, information and assistance (at Fairchild’s expense) for defense of the suit. Fairchild will pay damages and costs therein awarded against Customer but shall not be responsible for any compromise made without its consent. In no event shall Fairchild’s liability for such damages and costs (including legal costs) exceed the contractual value of the goods or services that are the subject of the lawsuit. In providing such defense, or in the event that such product is held to constitute infringement and the use of the product is enjoined, Fairchild, in its discretion, shall procure the right to continue using such product, or modify it so that it becomes non-infringing, or remove it and grant Customer a credit for the depreciated value thereof. Fairchild’s indemnity does not extend to claims of infringement arising from Fairchild’s compliance with Buyer’s design, specifications and/or instructions, or use of any product in combination with other products or in connection with a manufacturing or other process. The foregoing remedy is exclusive and constitutes Fairchild’s sole obligation for any claim of intellectual property infringement.

All solutions, designs, schematics, drawings, boards or other information provided by Fairchild to Customer are confidential and provided for Customer’s own use. Customer may not share any Fairchild materials with other semiconductor suppliers. For Fairchild Semiconductor Limited

.....
Name:
Date:



Warning

This Evaluation Board may employ high voltages so appropriate safety precautions should be used when operating this board. Replace components on the Evaluation Board only with those parts shown on the BOM. Contact an authorized Fairchild representative with any questions.

1.0 General Board Description

The FEB227 Evaluation Board is an isolated, primary-side regulated off-line AC/DC converter (power supply) in flyback technology. It has a universal input voltage range of $85V_{RMS}$ to $265V_{RMS}$ at a line frequency of 50Hz to 60Hz. It has one constant current output, selectable between 350mA and 700mA, both at a maximum output voltage of 17V. However the output current can easily be changed by changing one resistor.

The controller used on the FEB227 Evaluation Board is Fairchild Semiconductor's FAN102MY.

This highly integrated PWM controller provides several features to enhance the performance of low-power flyback converters. The patented topology enables most simplified circuit design, especially for battery charger applications. The result is a low-cost, smaller and lighter charger when compared to a conventional design or a linear transformer. The start-up current is only 10uA, which allows use of large start-up resistance for further power saving. To minimize the standby power consumption, the proprietary green-mode function provides off-time modulation to linearly decrease PWM frequency under light-load conditions. This green-mode function assists the power supply to easily meet the power conservation requirement. By using FAN102, a charger can be implemented with fewest external components and a minimized cost.

1.1 Contents of the FEB227 Evaluation Kit

- FEB227 Evaluation Board
- Data sheets for the parts listed below can be obtained on the Internet from Fairchild Semiconductor's website:
<http://www.fairchildsemi.com/>
 - FAN102MY
 - DF10S
 - RS1G/K
 - MM3Z24VB
 - ES3D
 - FCD4N60
 - BC846B
 - Application Note: AN-6067

1.2 Power Supply Specification Table

Minimum Line Voltage	$85V_{RMS}$
Maximum Line Voltage	$265V_{RMS}$
Line Frequency	50Hz to 60Hz
Output (selectable)	350mA/700mA constant current @ 17Vmax

2.0 Circuit Description

The input voltage is rectified and filtered by D101 and C102 to generate a DC voltage for the input of the flyback converter. Line filter LF101, X2 capacitor C101 and the X1/Y1 capacitor C1 act as an EMI filter. R101, C106 and D102 form a clamping network that limits the voltage spike due to the energy trapped in the leakage inductance of the transformer. After start-up R110/R112 are used to charge up C105. Once the threshold voltage is reached, IC101 is activated and draws its supply current from the Vcc winding (pins 4/5 of T1, rectified by D104). To keep the Vcc below a safe limit a simple linear regulator is used (C108, Q102, D105 and R111). The switching element Q101 is driven by the GATE pin via gate resistor R104. The output current level is determined by the current sense resistors R102 and R103. If J101 is open the current flows only through R102 and thus the output current is low. If J101 is shorted the current flows through the parallel connection of R102 and R103 and thus the output current is high. The voltage across R102/R103 is filtered by R105 and fed into the CS pin. The output voltage regulation is indirectly achieved by monitoring the Vcc level. To do this, Vcc is divided by R109 and R108 in order to get 2.5V at the voltage sense pin VS. C107 acts as a filter. The FAN102SZ has a built-in slope compensation. For frequency compensation R107/C103 are connected to the COMV pin and R106/C104 are connected to the COMI pin. The transformed voltage is rectified by D201 and filtered by the MLCC C201.

2.1 Board Photograph

- Top Side View



- Bottom Side View

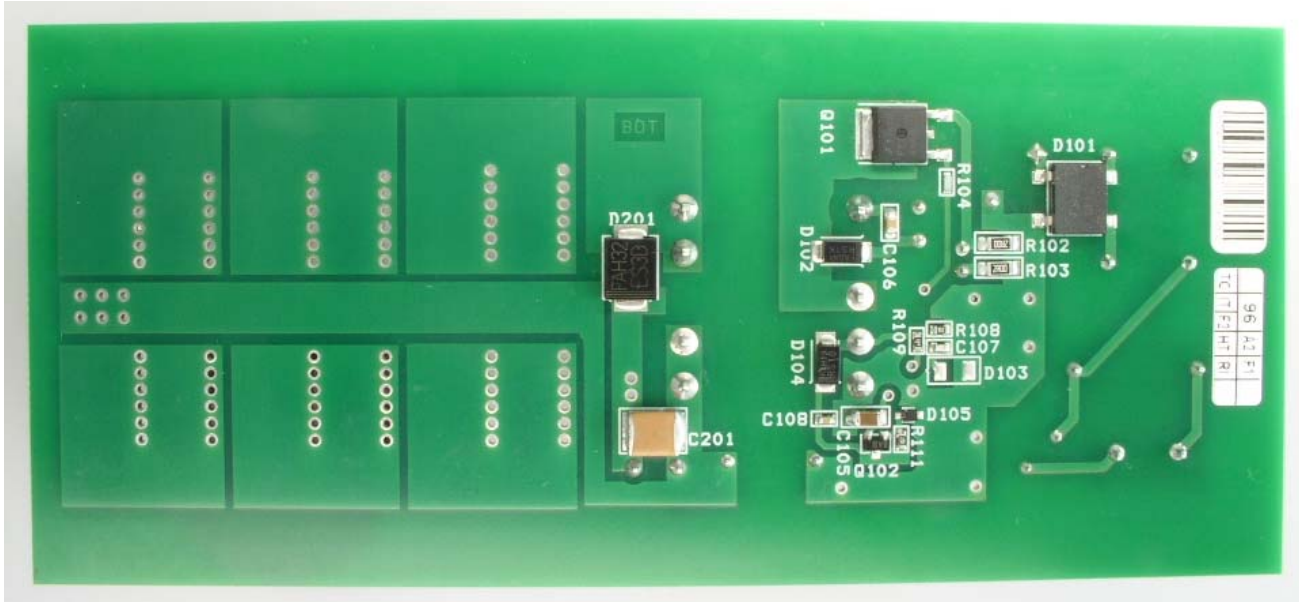

2.2.2. LED Section

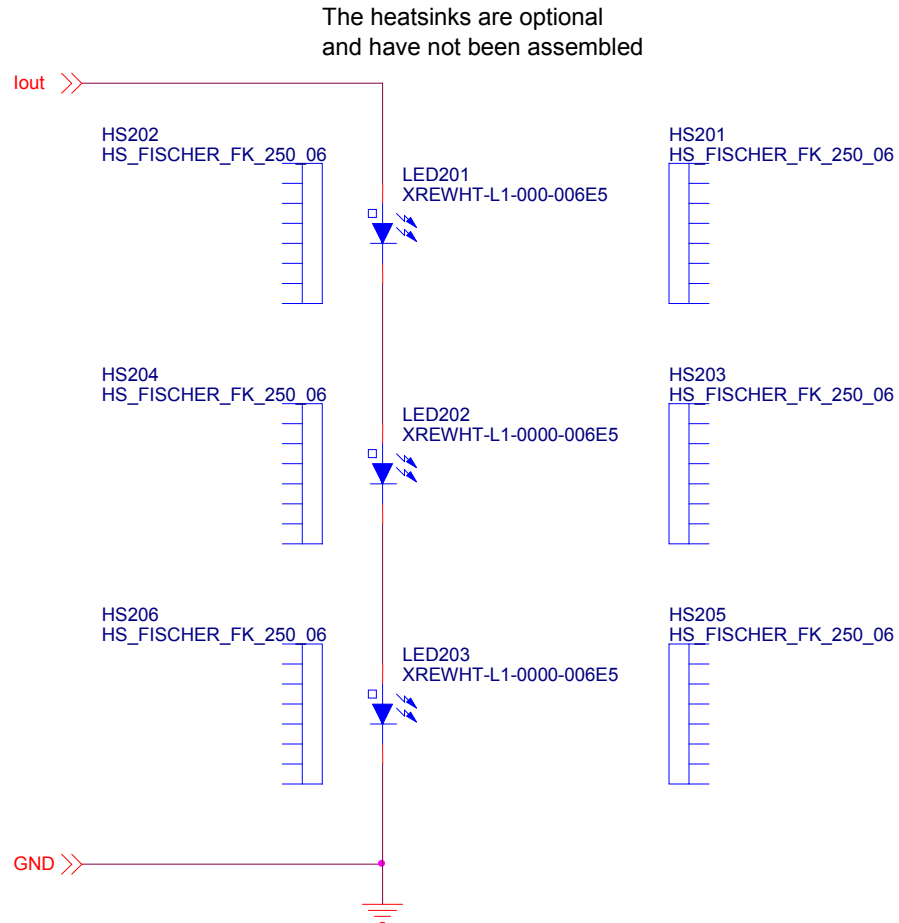

2.3 PCB Layout

- Top Side View

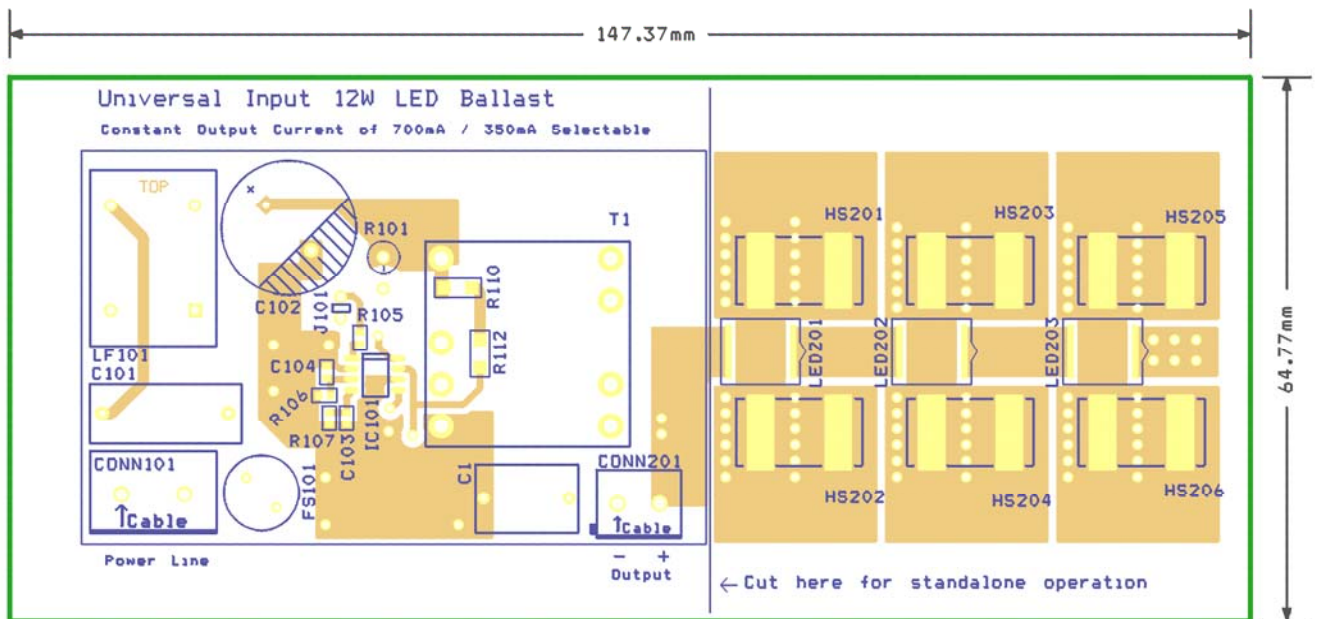

- Bottom Side View

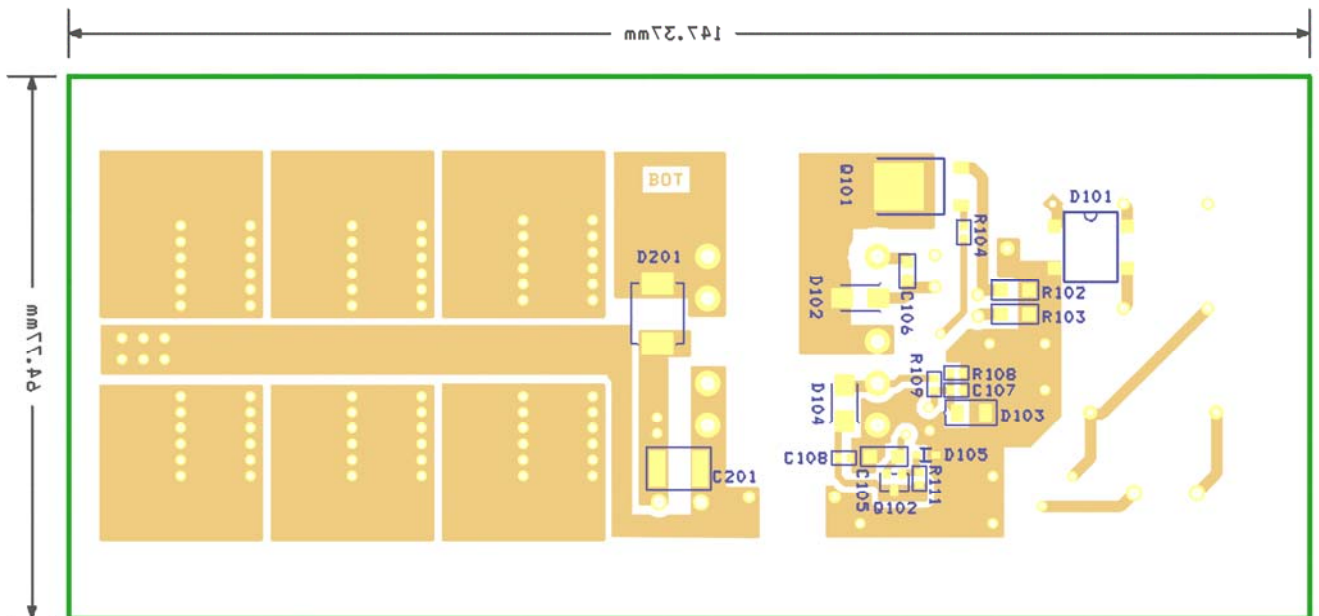

NB: Component D103 is not being assembled

2.4 Evaluation Board Connection

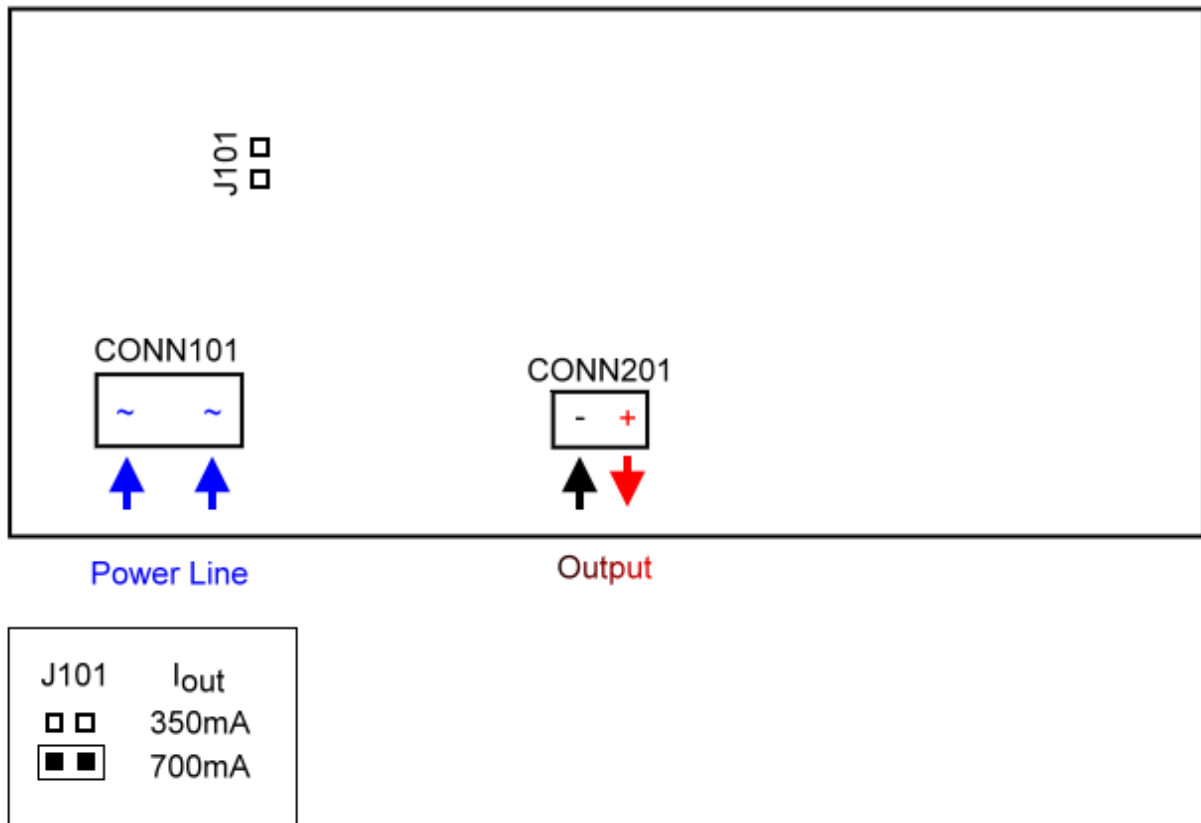

Important note:

Do not connect anything to CONN201 while operated with the on-board LEDs!

Warning:

The circuit is line connected and contains high voltages. Caution and proper procedures should be observed when using and making measurements on the board.

3.0 Test Equipment

- Oscilloscope: TEKTRONIX TDS784C (1GHz / 4GS/s) using voltage probes P5100, P6139A and current probe TCP202.
- Analyzer: TEKTRONIX 2712
- Multimeter: RMS MULTIMETER FLUKE 85 II
- Electronic Load: Prodigit 3000C Base unit using 3311C, 3314C and 2x 3332A modules
- Power Analyzer: LEM NORMA 5000
- AC Source: Chroma Programmable AC Source Model 61502
- Temp. Probe: Greisinger dual channel digital thermometer GMH3230 using two GTF300 NiCr-Ni thermocouples

The ambient temperature for all tests was 25 °C if not noted otherwise

4.0 Test Results

4.1 Standby Power vs Input Voltage ($I_{out(max)} = 350mA$)

4.1.1 Test Condition and Method

The input power for various input voltages was measured at no load and at minimum load (i.e. at $V_{out(min)}$). The standby power was calculated as $P_{Stdby} = P_{IN} - P_{OUT}$. At minimum load the output current was measured and the minimum and maximum deviation from the nominal output current calculated.

4.1.2 No Load Standby Power

V_{IN} [V _{RMS}]	85	110	130	150	180	210	230	240	265
P_{STDBY} [W]	0.30	0.31	0.32	0.34	0.37	0.41	0.43	0.44	0.46

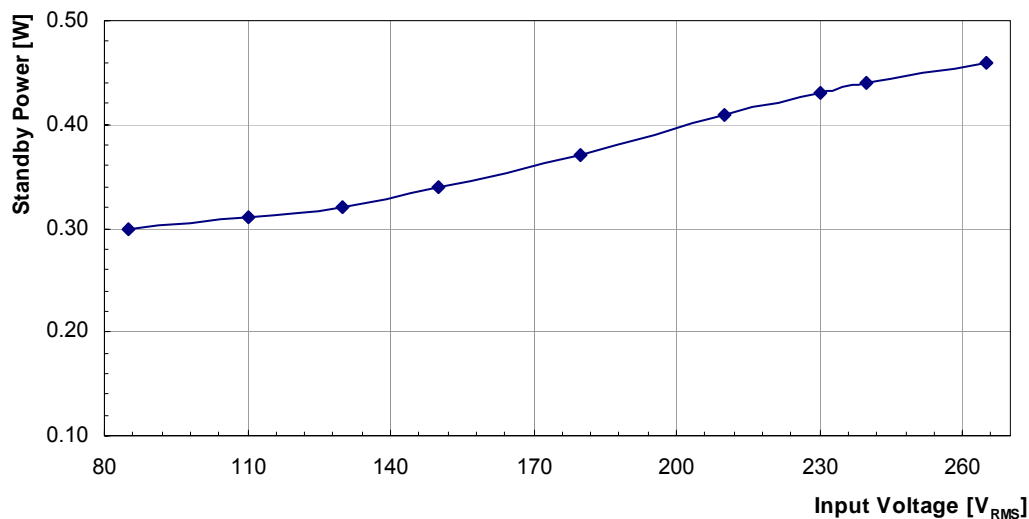

4.1.3 Accuracy of Output with No Load

V_{IN} [V _{RMS}]	85	110	130	150	180	210	230	240	265
V_{out} [V]	30.00	31.00	32.00	32.00	33.00	34.00	35.00	36.00	33.00

4.1.4 Minimum Load Standby Power

V_{IN} [V _{RMS}]	85	110	130	150	180	210	230	240	265
P_{STDBY} [W]	0.41	0.44	0.49	0.51	0.57	0.65	0.71	0.75	0.78

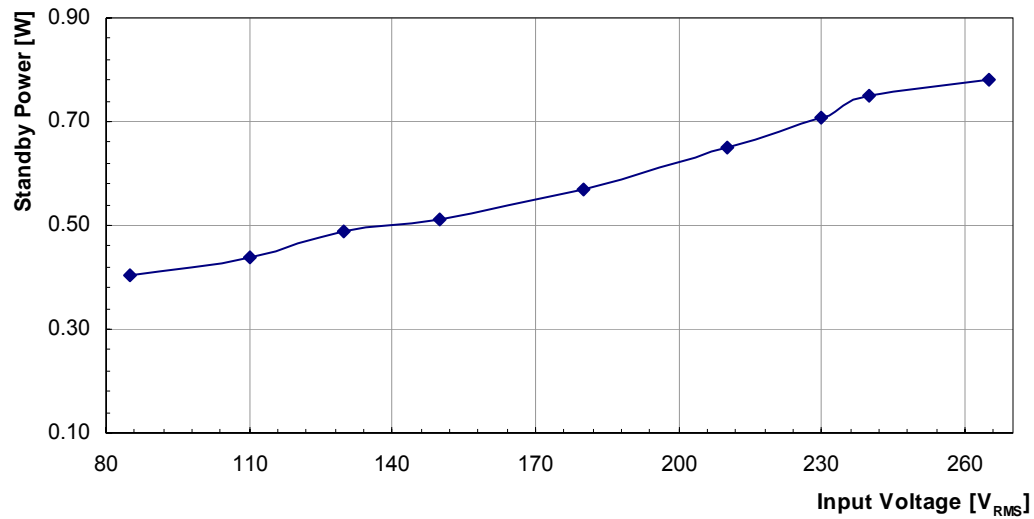

4.1.5 Output Current at Minimum Load

V_{IN} [V _{RMS}]	85	110	130	150	180	210	230	240	265		
V_{OUT} [V]	2.8	2.8	2.8	2.8	2.8	2.8	2.8	2.8	2.8	Min [%]	Max [%]
I_{OUT} [mA]	341	344	351	357	354	357	368	375	342	-2.6	7.1

4.2 Full Load Efficiency vs Input Voltage ($I_{out(max)} = 350mA$)

4.2.1 Test Condition and Method

The power supply was set up with its output loaded at maximum load. The input voltage was swept across the specified range. The output load was kept constant. The input power was measured and efficiency calculated.

4.2.2 Result

V_{IN} [V _{RMS}]	85	110	130	150	180	210	230	240	265
P_{OUT} [W]	5.20	5.24	5.27	5.30	5.33	5.36	5.37	5.38	5.36
P_{IN} [W]	6.63	6.64	6.70	6.73	6.81	6.91	6.98	7.01	7.03
Efficiency [%]	78.38	78.95	78.70	78.68	78.21	77.51	76.98	76.79	76.31

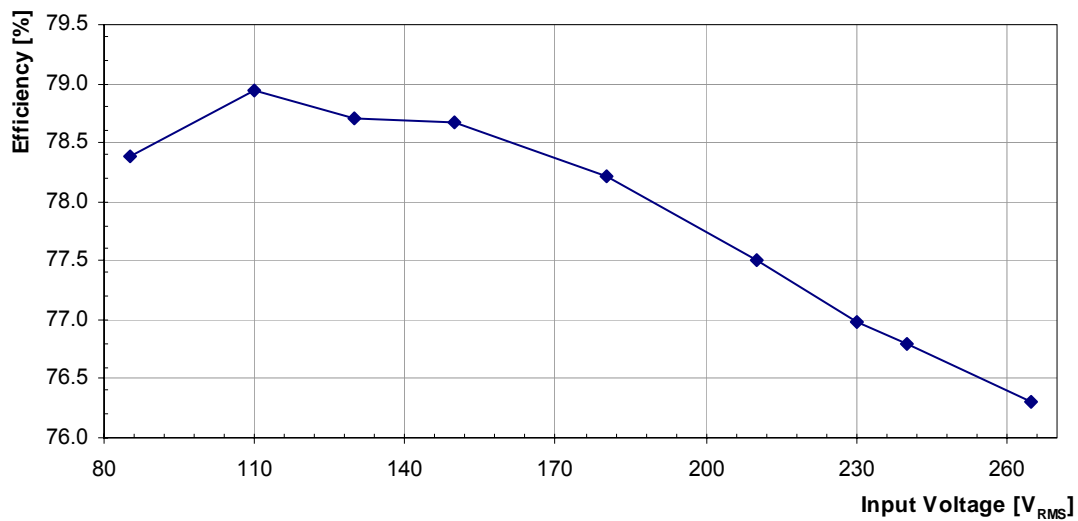

4.3 Line Regulation ($I_{out(max)} = 350mA$)

4.3.1 Test Condition and Method

The power supply was set up with its output loaded at maximum load. The input voltage was swept across its specified range. Output current was measured for each input voltage and was displayed relative to the nominal output current. The nominal current in this case is the current measured for the output at $V_{IN} = 230V_{RMS}$.

4.3.2 Result

The minimum and maximum values in the table below are calculated as deviations from the output voltage as specified in section 1.2.

V_{IN} [V_{RMS}]	85	110	130	150	180	210	230	240	265	Min [%]	Max [%]
I_{OUT} [mA]	305.40	308.20	310.00	311.30	313.10	314.90	315.90	316.50	315.20	-12.7	-9.6

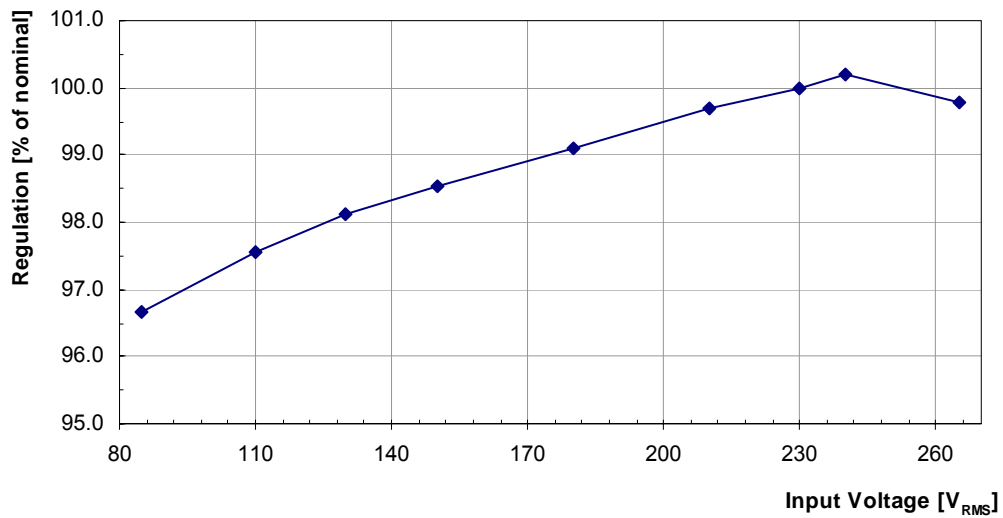

4.4 Load Regulation ($I_{out(max)} = 350mA$)

4.4.1 Test Condition and Method

The load voltage of the output is swept from 2.0V to 19V and the output current is being measured. These measurements are done with 110V_{RMS} and 230V_{RMS} input voltage.

4.4.2 Result for $V_{in} = 110V_{RMS}$

V_{out} [V]	2.00	2.25	2.50	2.80	4.38	5.96	7.53
I_{out} [mA]	325.00	336.00	343.00	345.60	343.80	340.00	336.00

V_{out} [V]	9.11	10.69	12.27	13.84	15.42	17.00	17.25
I_{out} [mA]	333.40	327.00	322.00	317.00	312.60	308.30	307.60

V_{out} [V]	17.50	17.75	18.00	18.25	18.50	18.75	19.00
I_{out} [mA]	305.90	271.00	230.40	183.80	142.80	105.00	70.80

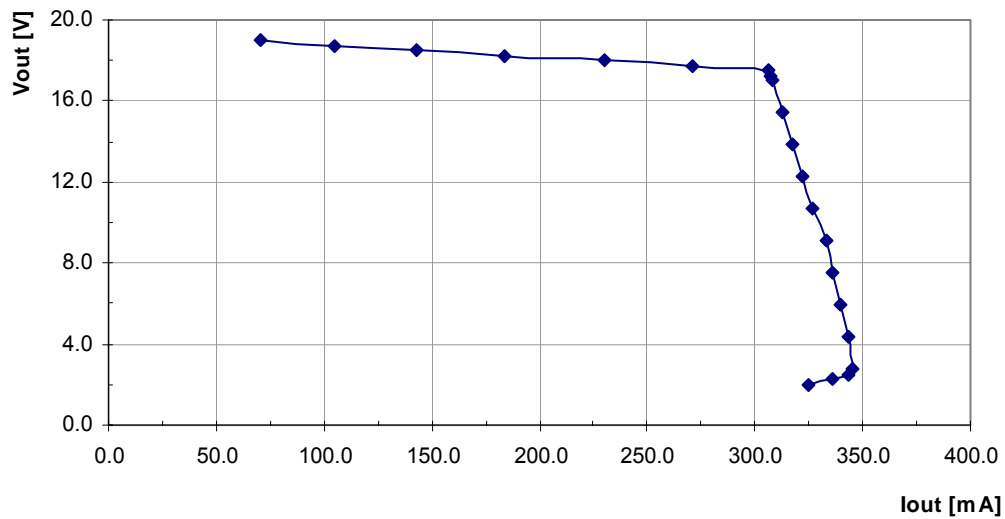

4.4.3 Result for $V_{in} = 230V_{RMS}$

V_{out} [V]	2.00	2.25	2.50	2.80	4.38	5.96	7.53
I_{out} [mA]	361.60	371.10	360.00	365.00	336.00	340.00	341.30

V_{out} [V]	9.11	10.69	12.27	13.84	15.42	17.00	17.25
I_{out} [mA]	347.00	336.80	331.00	323.00	320.60	316.00	315.10

V_{out} [V]	17.50	17.75	18.00	18.25	18.50	18.75	19.00
I_{out} [mA]	314.40	313.80	307.90	250.10	193.20	145.20	98.80

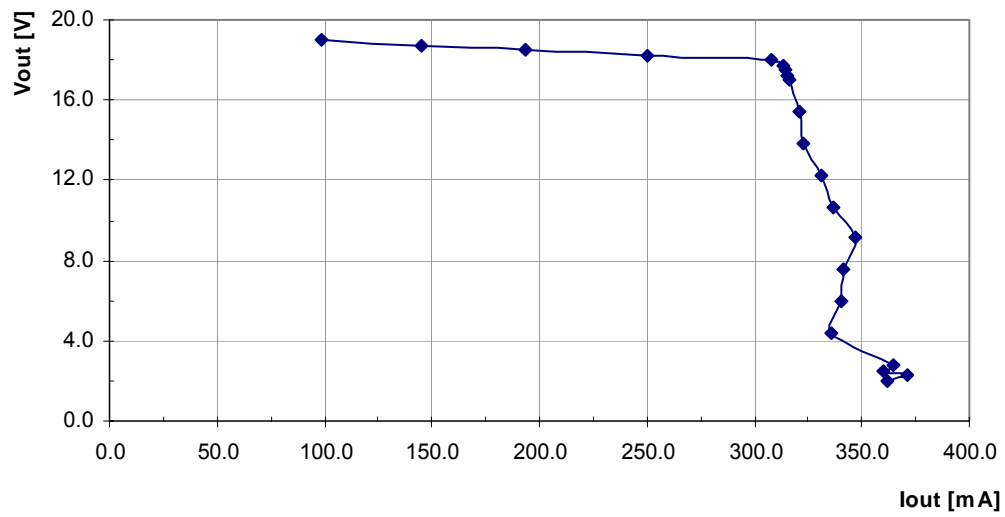

4.5 Standby Power vs Input Voltage ($I_{out(max)} = 700mA$)

4.5.1 Test Condition and Method

The input power for various input voltages was measured at no load and at minimum load (i.e. at $V_{out(min)}$). The standby power was calculated as $P_{Standby} = P_{IN} - P_{OUT}$. At minimum load the output current was measured and the minimum and maximum deviation from the nominal output current calculated.

4.5.2 No Load Standby Power

V_{IN} [V _{RMS}]	85	110	130	150	180	210	230	240	265
P_{STDBY} [W]	0.41	0.48	0.49	0.50	0.51	0.55	0.61	0.62	0.64

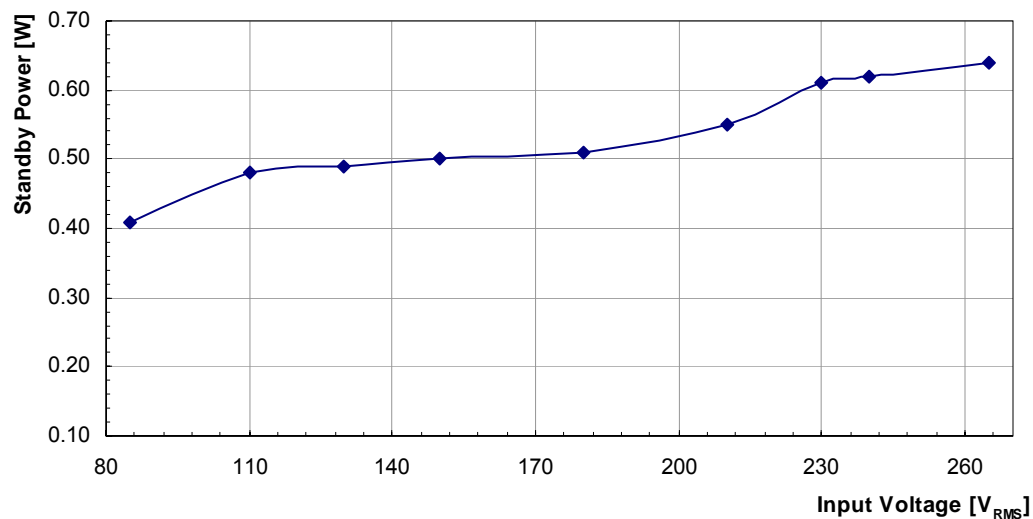

4.5.3 Accuracy of Output with No Load

V_{IN} [V _{RMS}]	85	110	130	150	180	210	230	240	265
V_{out} [V]	38.5	42.4	45.0	46.0	46.0	49.0	49.0	49.0	50.0

4.5.4 Minimum Load Standby Power

V_{IN} [VRMS]	85	110	130	150	180	210	230	240	265
P_{STDBY} [W]	0.64	0.67	0.71	0.76	0.82	0.89	0.94	0.96	1.04

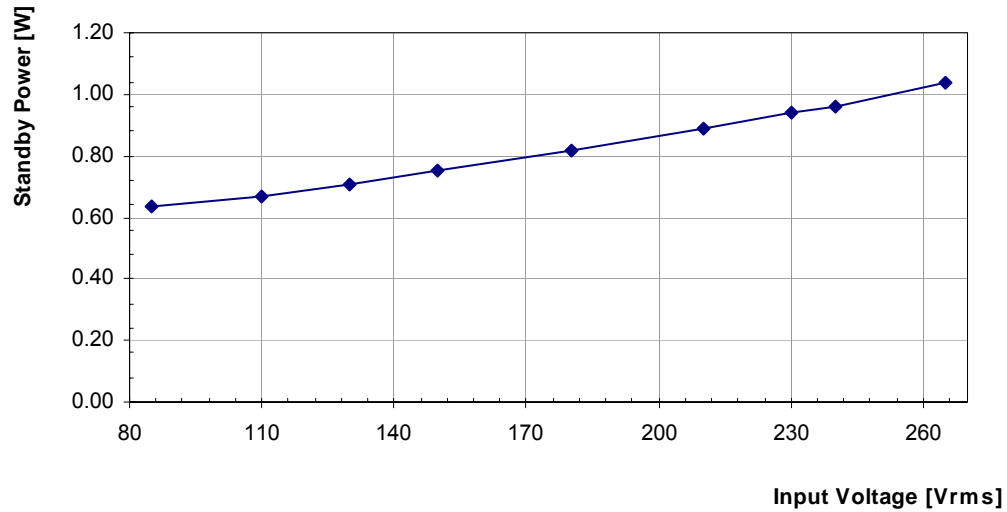

4.5.5 Output Current at Minimum Load

V_{IN} [VRMS]	85	110	130	150	180	210	230	240	265		
V_{OUT} [V]	2.8	2.8	2.8	2.8	2.8	2.8	2.8	2.8	2.8	Min [%]	Max [%]
I_{OUT} [mA]	536	555	566	576	589	599	602	603	606	-23.4	-13.4

4.6 Full Load Efficiency vs Input Voltage ($I_{out(max)} = 700mA$)

4.6.1 Test Condition and Method

The power supply was set up with its output loaded at maximum load. The input voltage was swept across the specified range. The output load was kept constant. The input power was measured and efficiency calculated.

4.6.2 Result

V_{IN} [V _{RMS}]	85	110	130	150	180	210	230	240	265
P_{OUT} [W]	10.20	10.90	10.94	10.97	11.05	11.10	11.12	11.14	11.18
P_{IN} [W]	12.58	13.21	13.23	13.22	13.38	13.45	13.50	13.54	13.64
Efficiency [%]	81.08	82.51	82.69	82.98	82.59	82.53	82.37	82.27	81.96

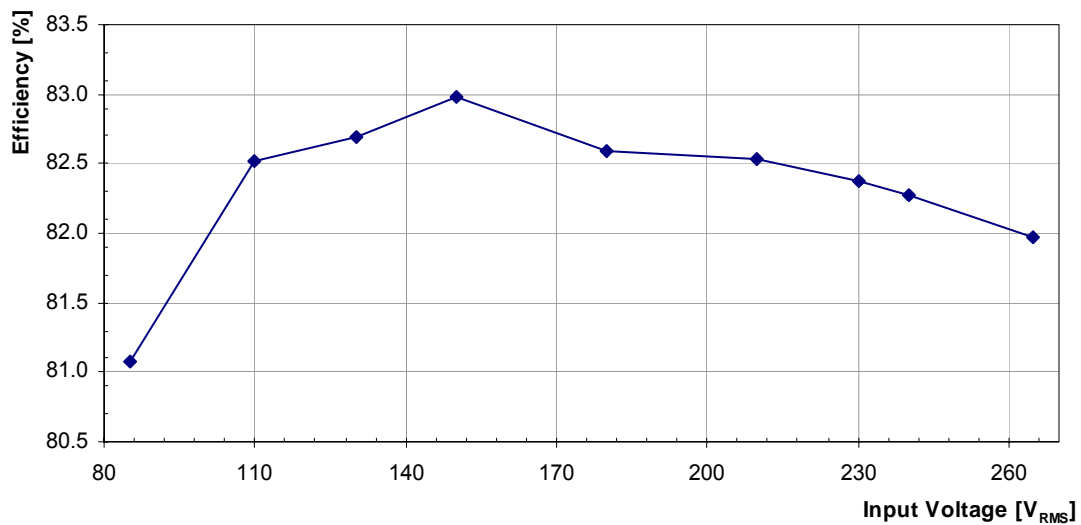

4.7 Line Regulation ($I_{out(max)} = 700mA$)

4.7.1 Test Condition and Method

The power supply was set up with its output loaded at maximum load. The input voltage was swept across its specified range. Output current was measured for each input voltage and was displayed relative to the nominal output current. The nominal current in this case is the current measured for the output at $V_{IN} = 230V_{RMS}$.

4.7.2 Result

The minimum and maximum values in the table below are calculated as deviations from the output voltage as specified in section 1.2.

V_{IN} [V_{RMS}]	85	110	130	150	180	210	230	240	265	Min [%]	Max [%]
I_{OUT} [mA]	599.70	640.00	643.00	645.00	649.70	652.40	654.00	654.80	657.00	-14.3	-6.1

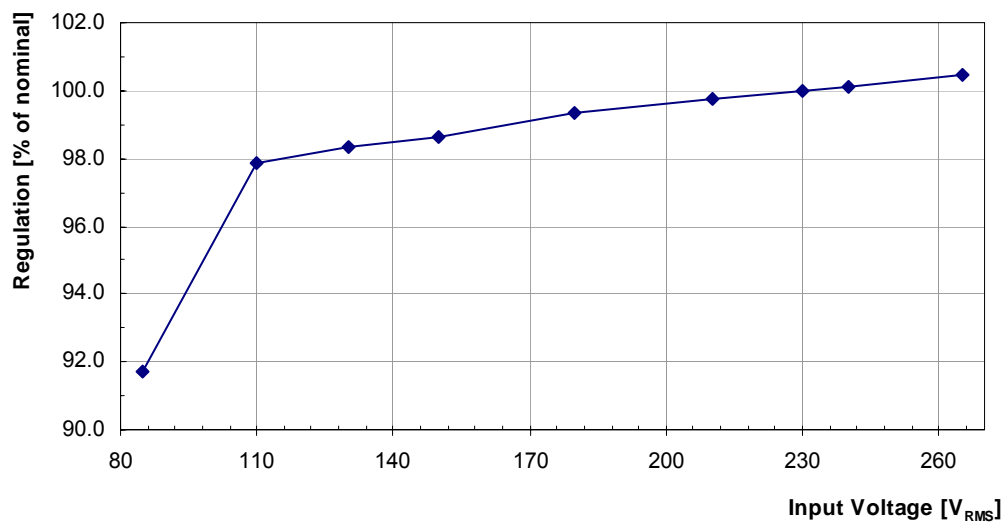

4.8 Load Regulation ($I_{out(max)} = 700mA$)

4.8.1 Test Condition and Method

The load voltage of the output is swept from 2.0V to 19V and the output current is being measured. These measurements are done with 110V_{RMS} and 230V_{RMS} input voltage.

4.8.2 Result for $V_{in} = 110V_{RMS}$

V_{out} [V]	2.00	2.25	2.50	2.80	4.38	5.96	7.53
I_{out} [mA]	510.00	527.00	541.00	555.50	616.00	654.10	675.00

V_{out} [V]	9.11	10.69	12.27	13.84	15.42	17.00	17.25
I_{out} [mA]	677.80	670.00	663.00	655.70	648.20	640.20	638.60

V_{out} [V]	17.50	17.75	18.00	18.25	18.50	18.75	19.00
I_{out} [mA]	637.00	630.50	543.00	431.60	332.00	243.00	167.00

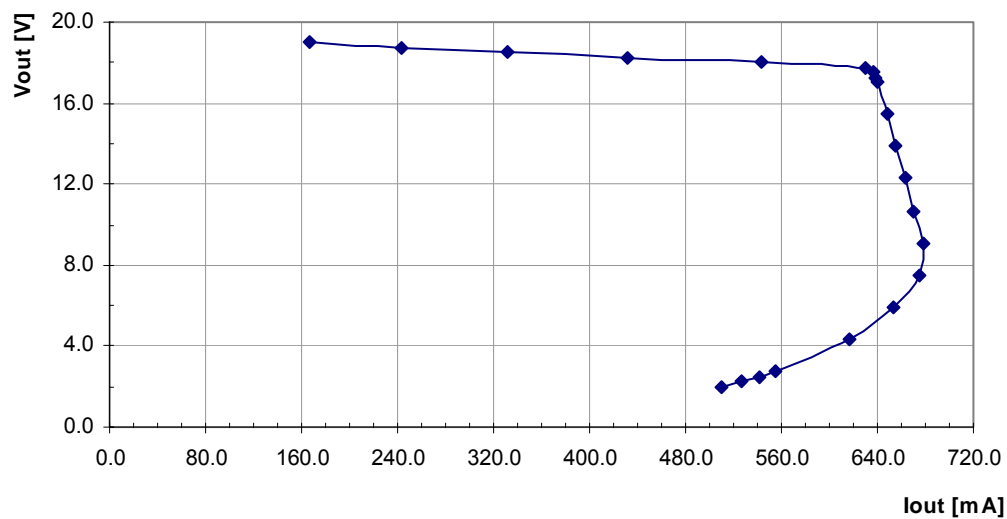

4.8.3 Result for $V_{in} = 230V_{RMS}$

V_{out} [V]	2.00	2.25	2.50	2.80	4.38	5.96	7.53
I_{out} [mA]	545.00	569.00	591.00	603.00	684.50	706.00	700.00

V_{out} [V]	9.11	10.69	12.27	13.84	15.42	17.00	17.25
I_{out} [mA]	692.00	683.80	676.50	669.00	662.00	654.40	653.10

V_{out} [V]	17.50	17.75	18.00	18.25	18.50	18.75	19.00
I_{out} [mA]	651.80	648.10	625.50	585.00	442.00	322.00	217.00

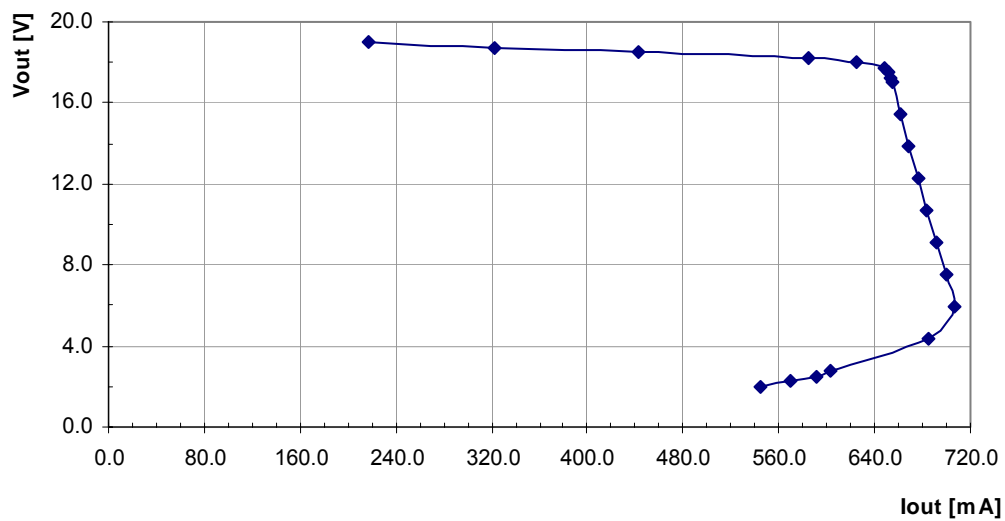

4.9 Output Ripple & Noise

4.9.1 Test condition and Method for Voltage Ripple and Noise

The output was loaded with the maximum load. The so-called PARD (periodic and random disturbance) method was used to measure ripple and noise voltage in AC coupling mode. See for example Celestica application note AN-1259-1-R2.

IMPORTANT NOTE: Output voltage ripple measurements cannot be made using a normal oscilloscope probe set-up. Magnetic field coupling into the ground connection for the oscilloscope probe could cause noise voltages far greater than the true ripple voltage. The test was done with $I_{out(max)} = 350mA$ and $I_{out(max)} = 700mA$ respectively. A V_{IN} of $110V_{RMS}$ and $230V_{RMS}$ was used.

4.9.2 Result for $I_{out(max)} = 350mA$

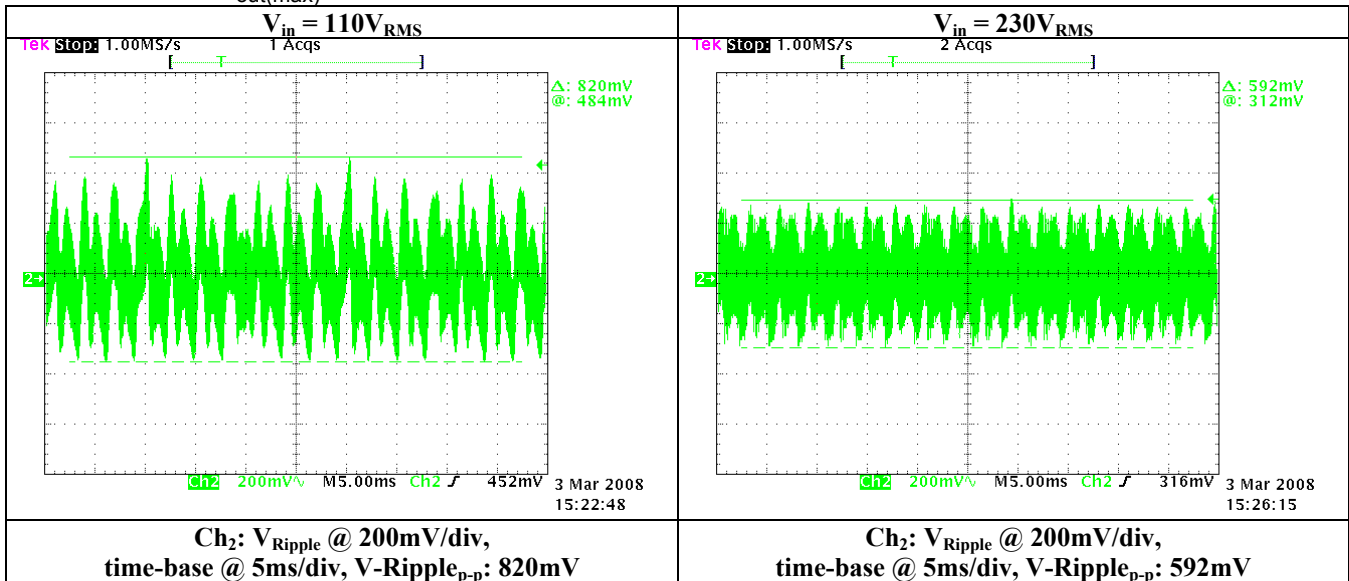

4.9.3 Result for $I_{out(max)} = 700mA$

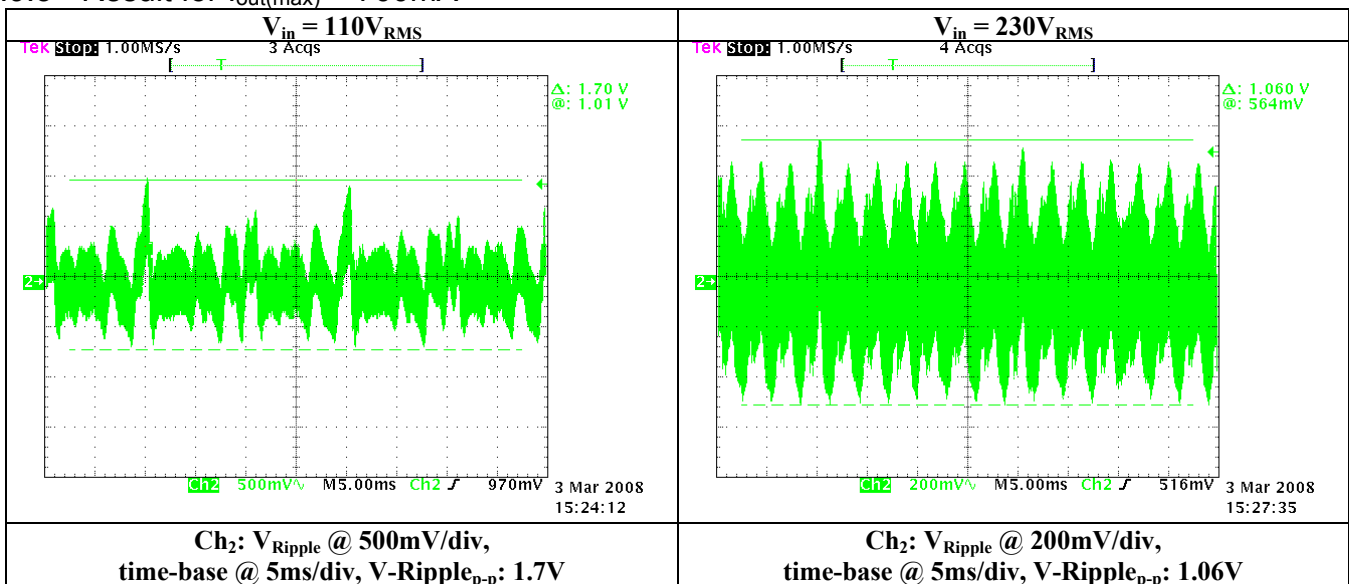

4.9.4 Test condition and Method for Current Ripple

The output was loaded with the maximum load. Using a current probe as mentioned in section 3.0. the output current was traced. The test was done with $I_{out(max)} = 350mA$ and $I_{out(max)} = 700mA$ respectively. A V_{IN} of $110V_{RMS}$ and $230V_{RMS}$ was used.

4.9.5 Result for $I_{out(max)} = 350mA$

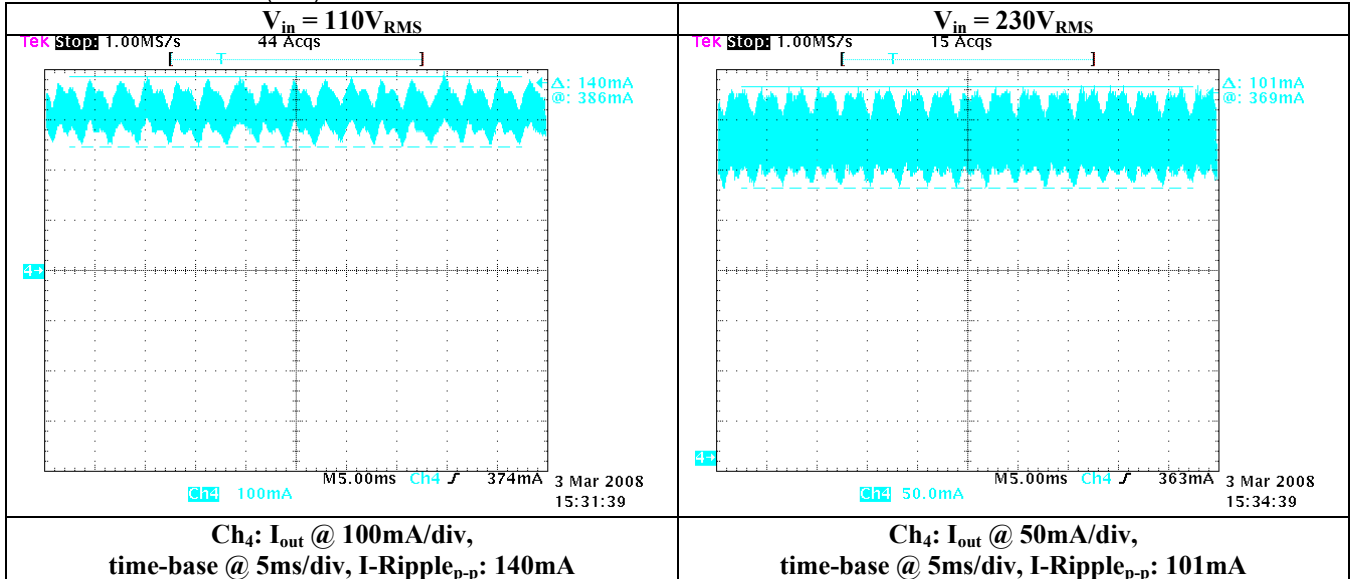

4.9.6 Result for $I_{out(max)} = 700mA$

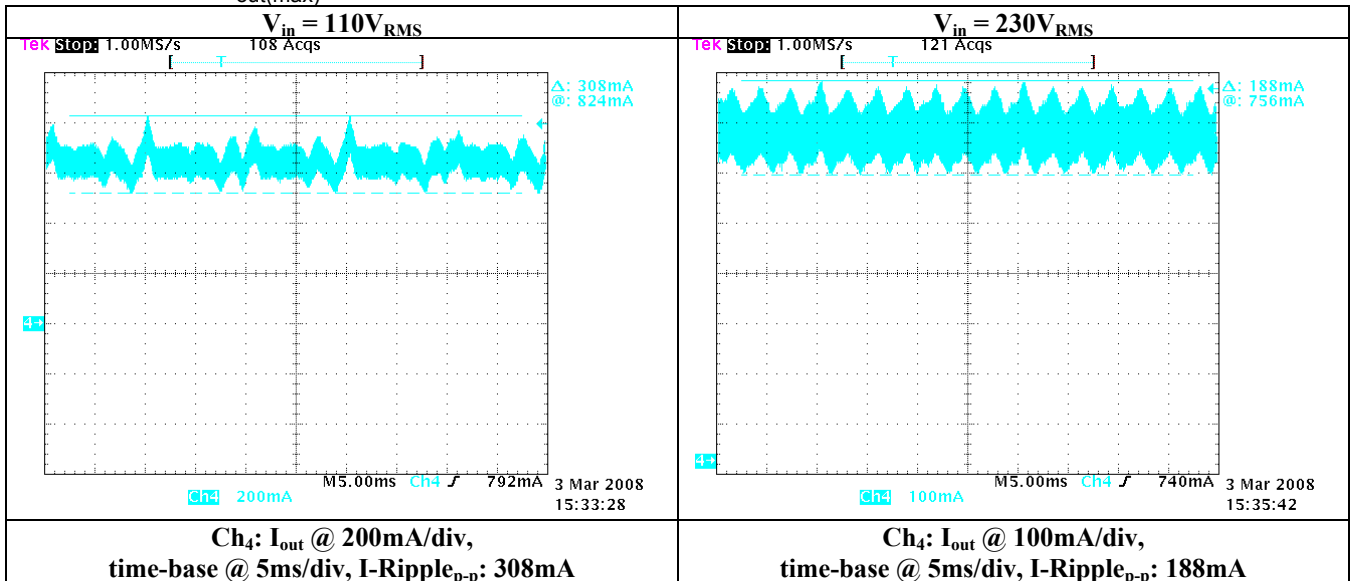

4.10 Soft Start Test

4.10.1 Test Condition and Method

The output was loaded with the maximum load. The voltage on the output as well as the drain voltage and drain current of Q101 were measured during a power up sequence. The test was done with $I_{out(max)} = 350mA$ and $I_{out(max)} = 700mA$ respectively. A V_{IN} of $110V_{RMS}$ and $230V_{RMS}$ was used.

4.10.2 Result for $I_{out(max)} = 350mA @ V_{IN} = 110V_{RMS}$

Output Voltage

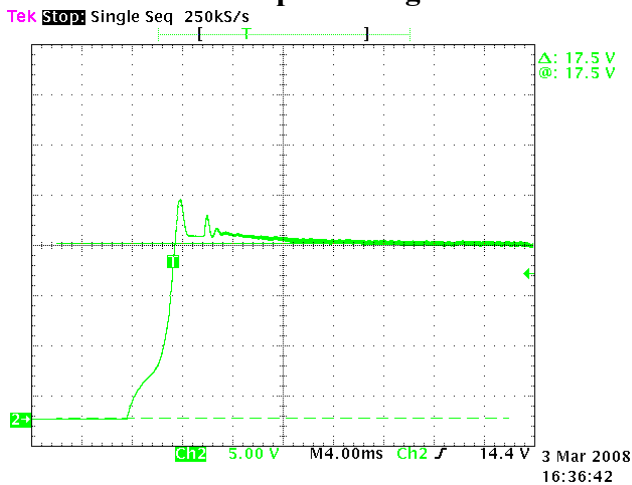

Ch2: V_{OUT} @ 5V/div, time-base @ 4ms/div

Drain Voltage and Drain Current

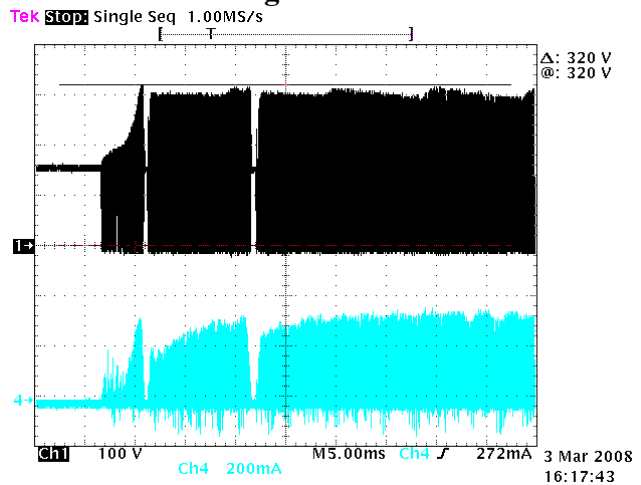

Ch1: V_{Drain} @ 100V/div, Ch4: I_{Drain} @ 200mA/div, time-base @ 5ms/div, $V_{Drain(max)} = 320V$

4.10.3 Result for $I_{out(max)} = 350mA @ V_{IN} = 230V_{RMS}$

Output Voltage

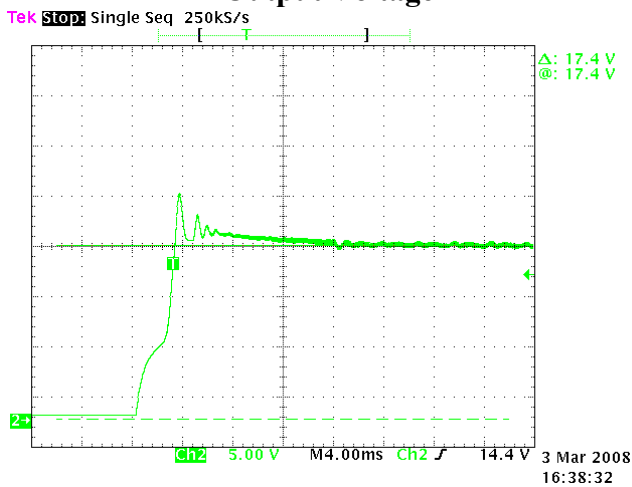

Ch2: V_{OUT} @ 5V/div, time-base @ 4ms/div

Drain Voltage and Drain Current

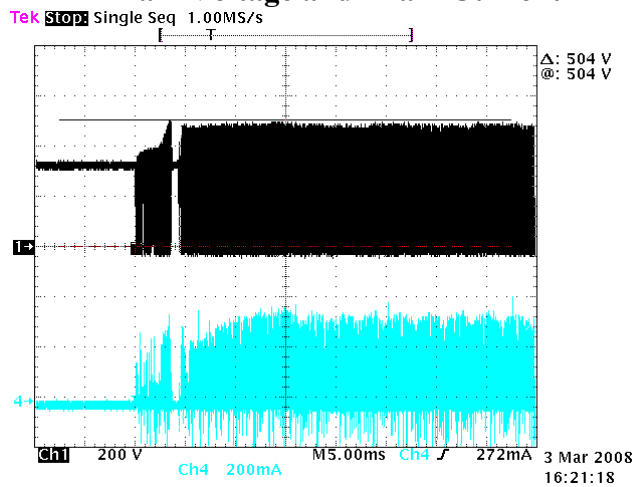

Ch1: V_{Drain} @ 200V/div, Ch4: I_{Drain} @ 200mA/div, time-base @ 5ms/div, $V_{Drain(max)} = 504V$

4.10.4 Result for $I_{out(max)} = 700mA @ V_{IN} = 110V_{RMS}$

Output Voltage

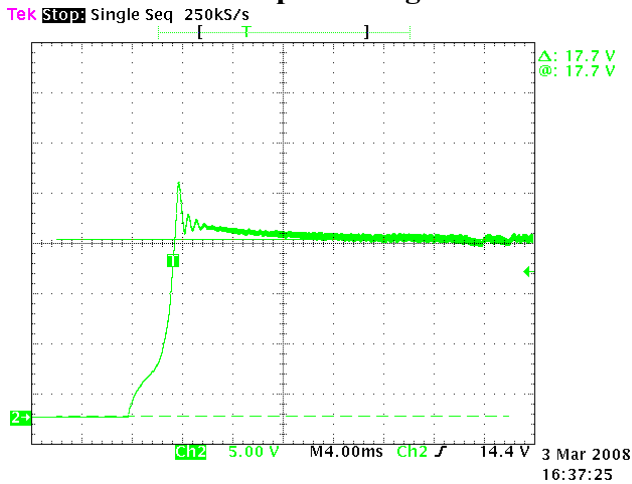

Ch2: V_{OUT} @ 5V/div, time-base @ 4ms/div

Drain Voltage and Drain Current

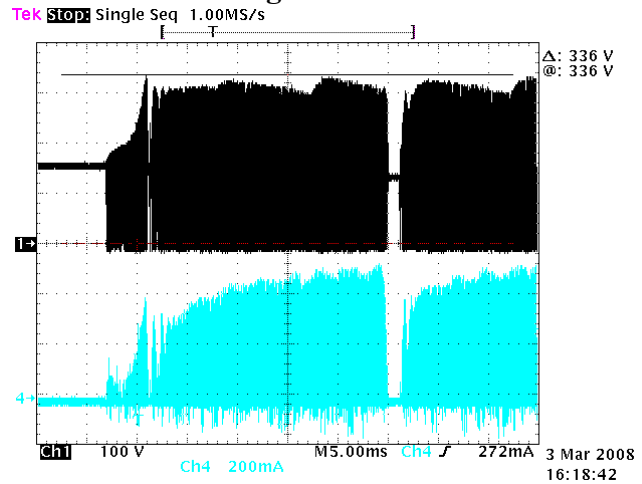

Ch1: V_{Drain} @ 100V/div, Ch4: I_{Drain} @ 200mA/div, time-base @ 5ms/div, $V_{Drain(max)} = 336V$

4.10.5 Result for $I_{out(max)} = 700mA @ V_{IN} = 230V_{RMS}$

Output Voltage

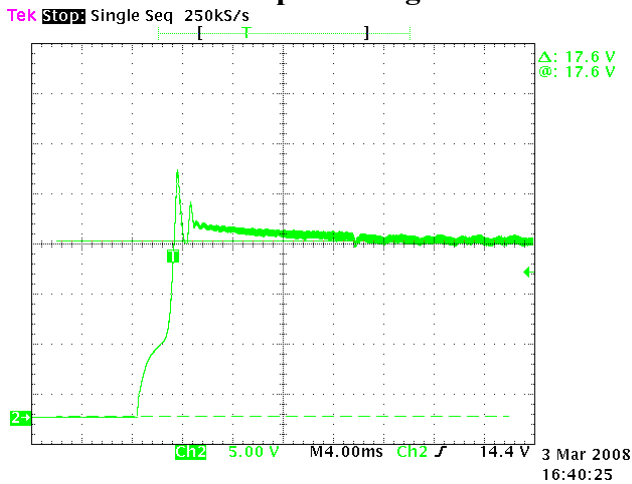

Ch2: V_{OUT} @ 5V/div, time-base @ 4ms/div

Drain Voltage and Drain Current

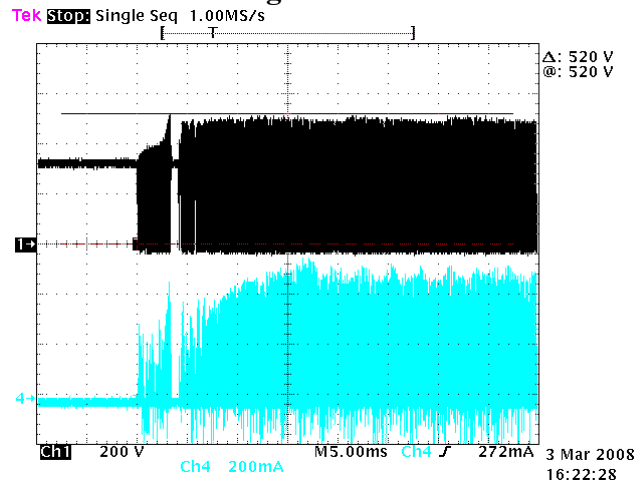

Ch1: V_{Drain} @ 200V/div, Ch4: I_{Drain} @ 200mA/div, time-base @ 5ms/div, $V_{Drain(max)} = 520V$

4.11 Output Short Circuit Protection Test

4.11.1 Test Condition and Method

The output was shorted. The voltages on the V_{cc}, CS, COMI and COMV pins were measured with an input voltage of V_{IN} = 265V_{RMS}.

4.11.2 Result for V_{cc} and CS pin

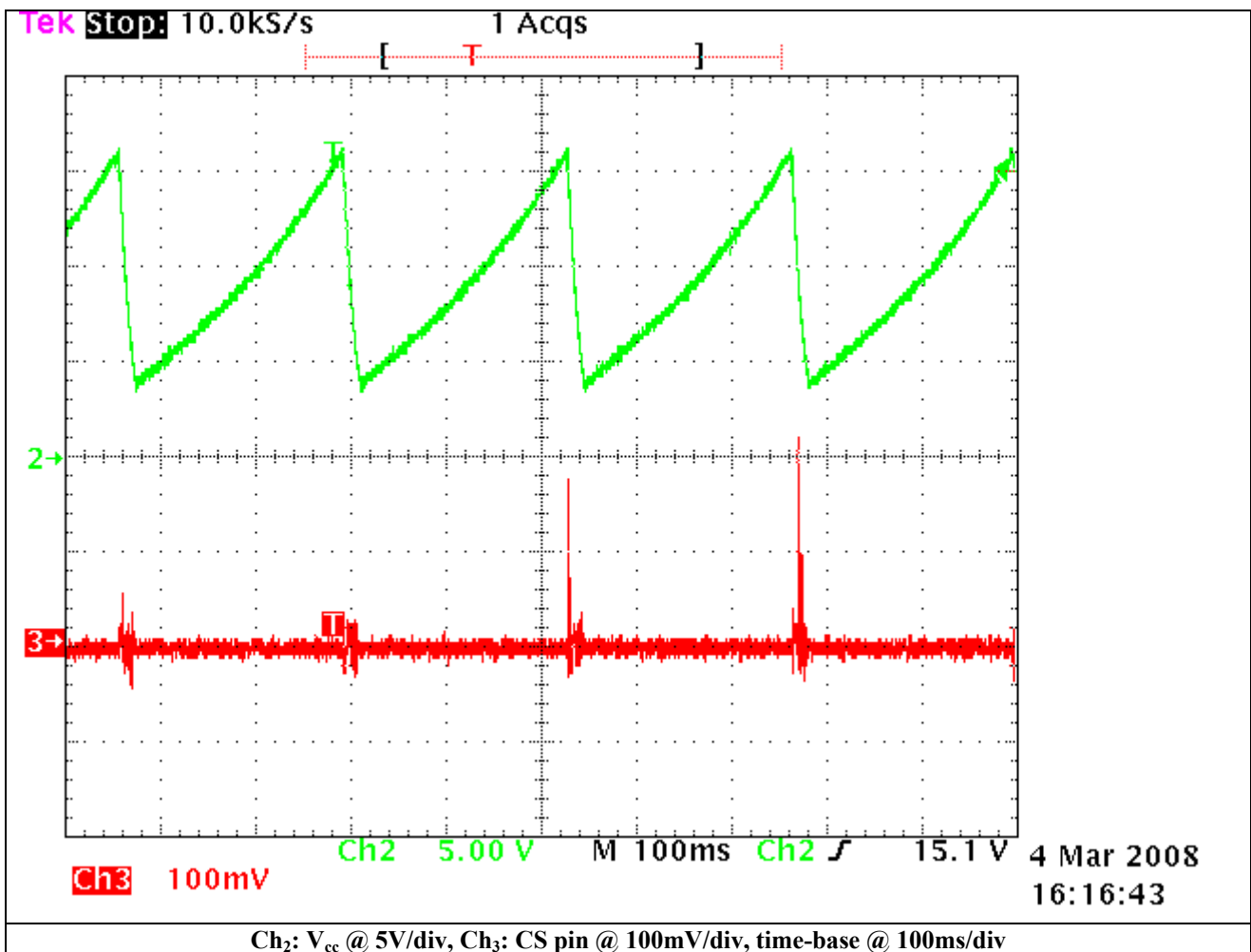

4.11.3 Result for COMI and COMV pin

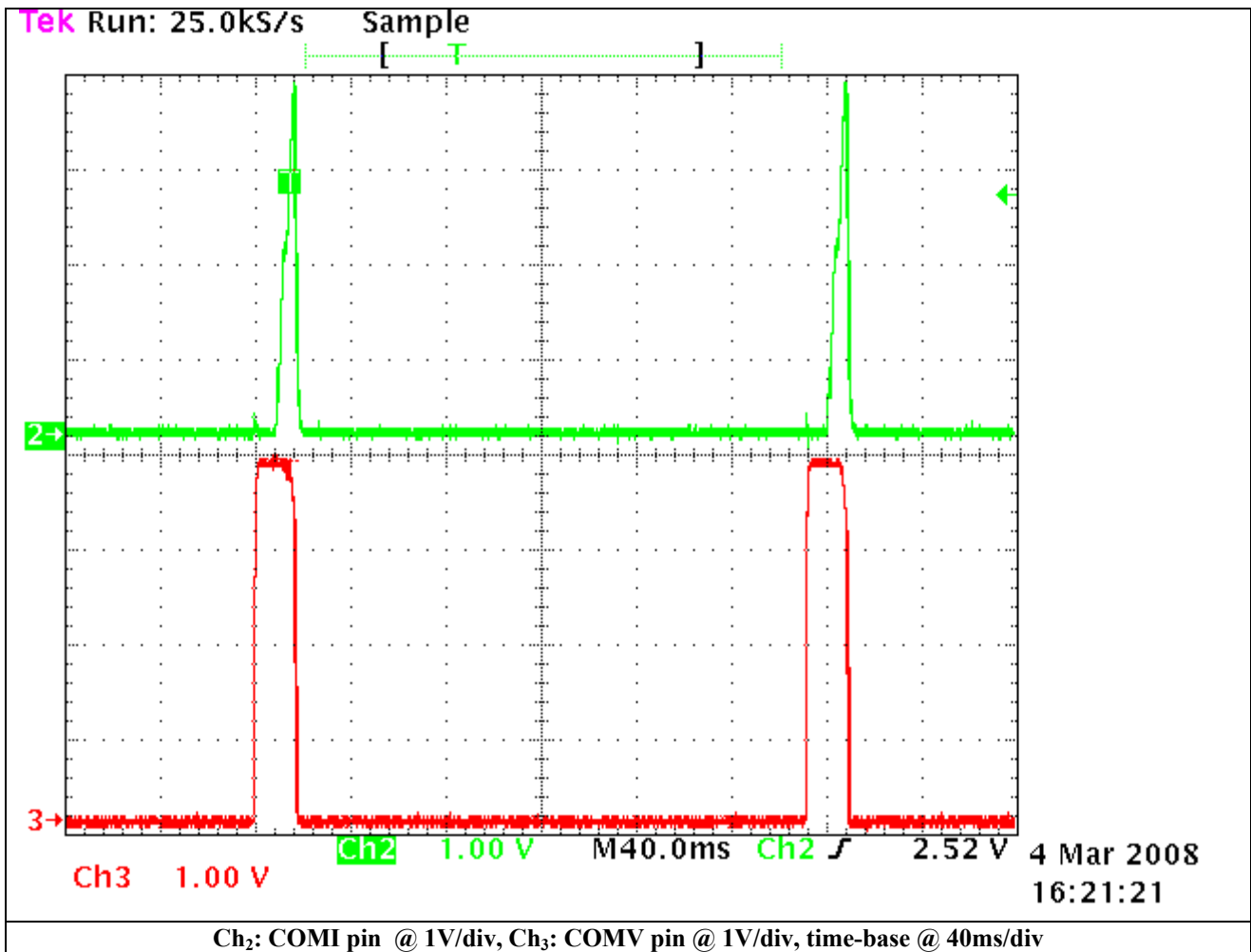

4.12 Typical Drain Waveforms

4.12.1 Test Condition and Method

The output was loaded with maximum load. The drain voltage and drain current of Q101 were measured. The test was done with $I_{out(max)} = 350mA$ and $I_{out(max)} = 700mA$ respectively. A V_{IN} of $110V_{RMS}$ and $230V_{RMS}$ was used.

4.12.2 Result for $I_{out(max)} = 350mA @ V_{in} = 110V_{RMS}$

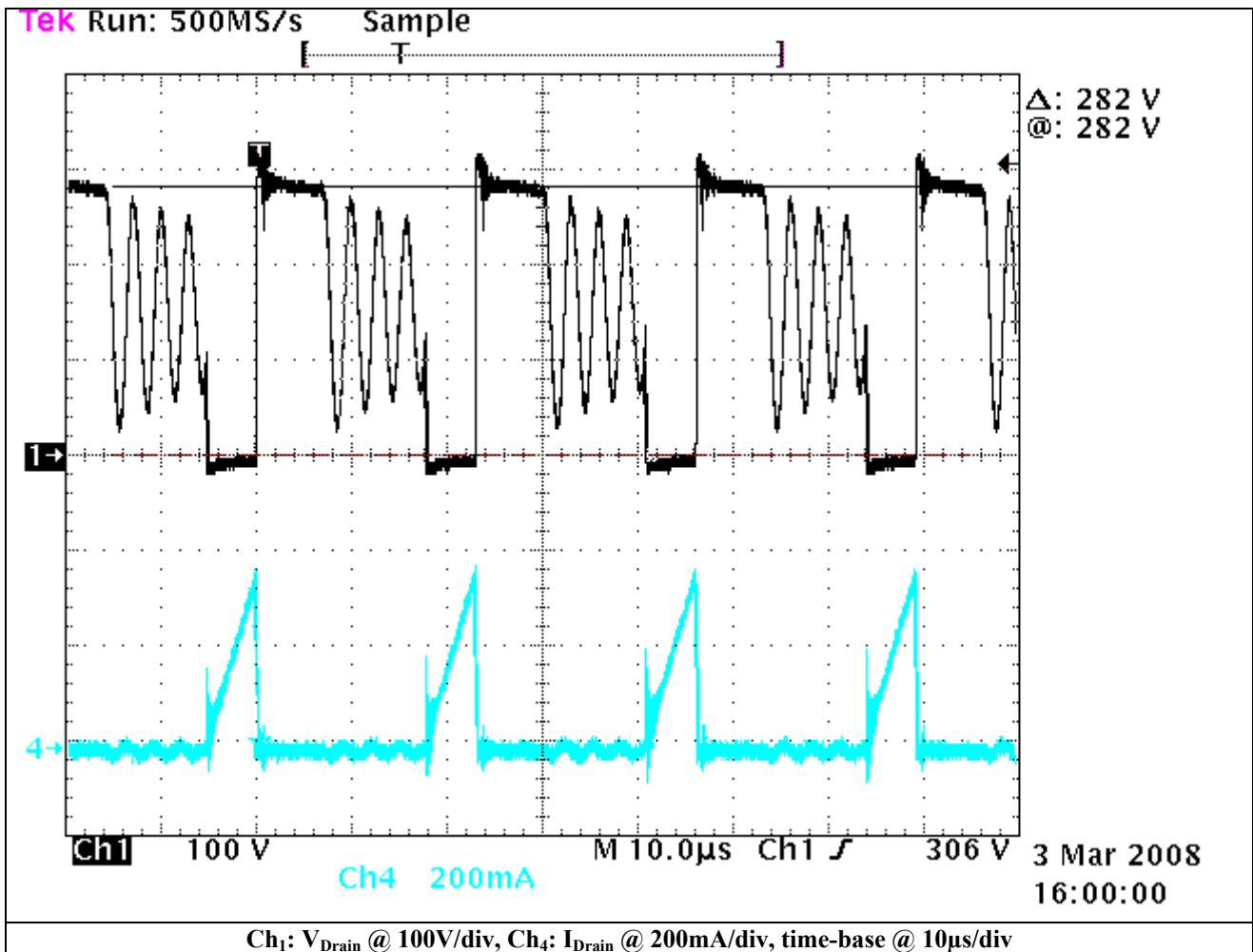

4.12.3 Result for $I_{out(max)} = 350mA @ V_{in} = 230V_{RMS}$

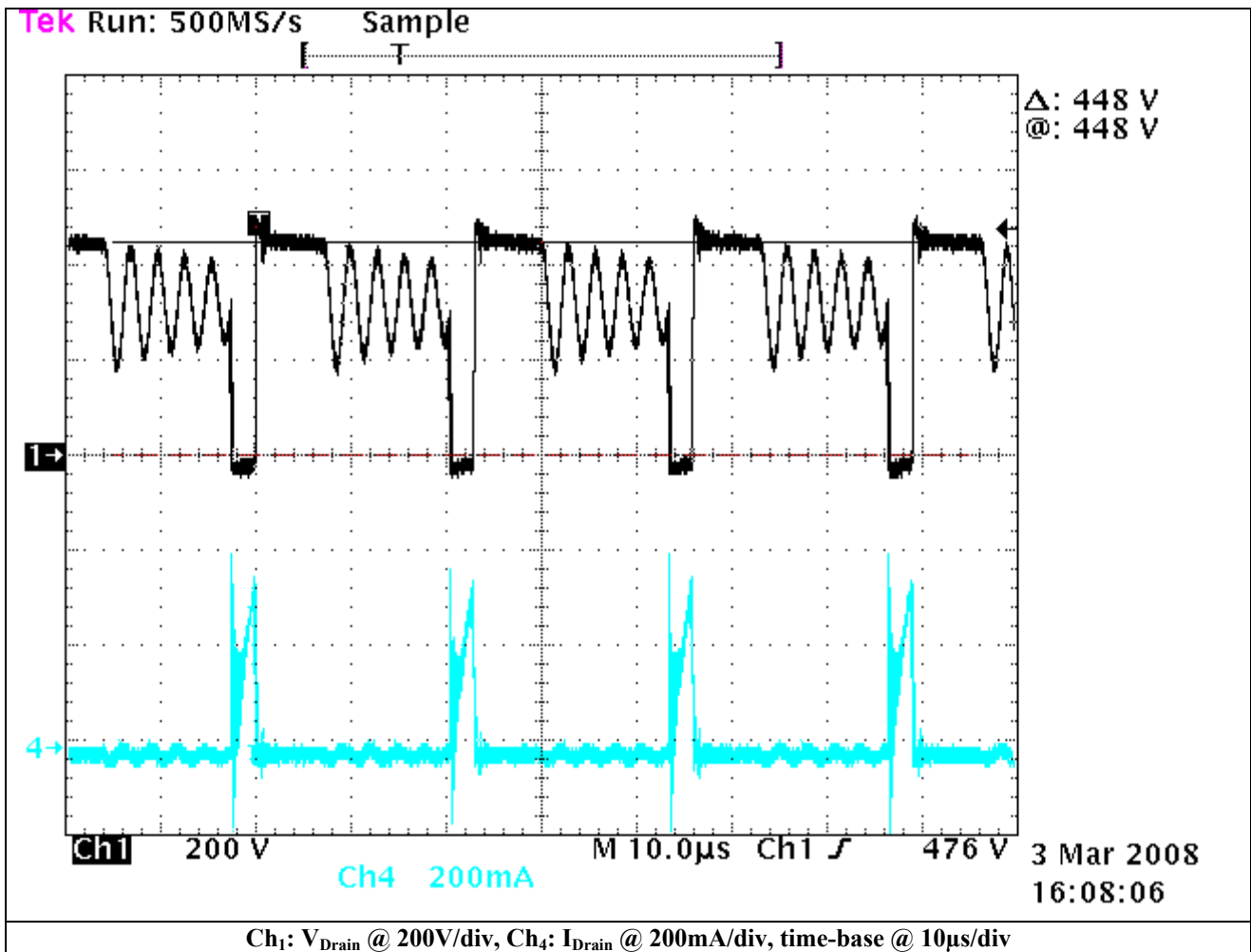

4.12.4 Result for $I_{out(max)} = 700mA @ V_{in} = 110V_{RMS}$

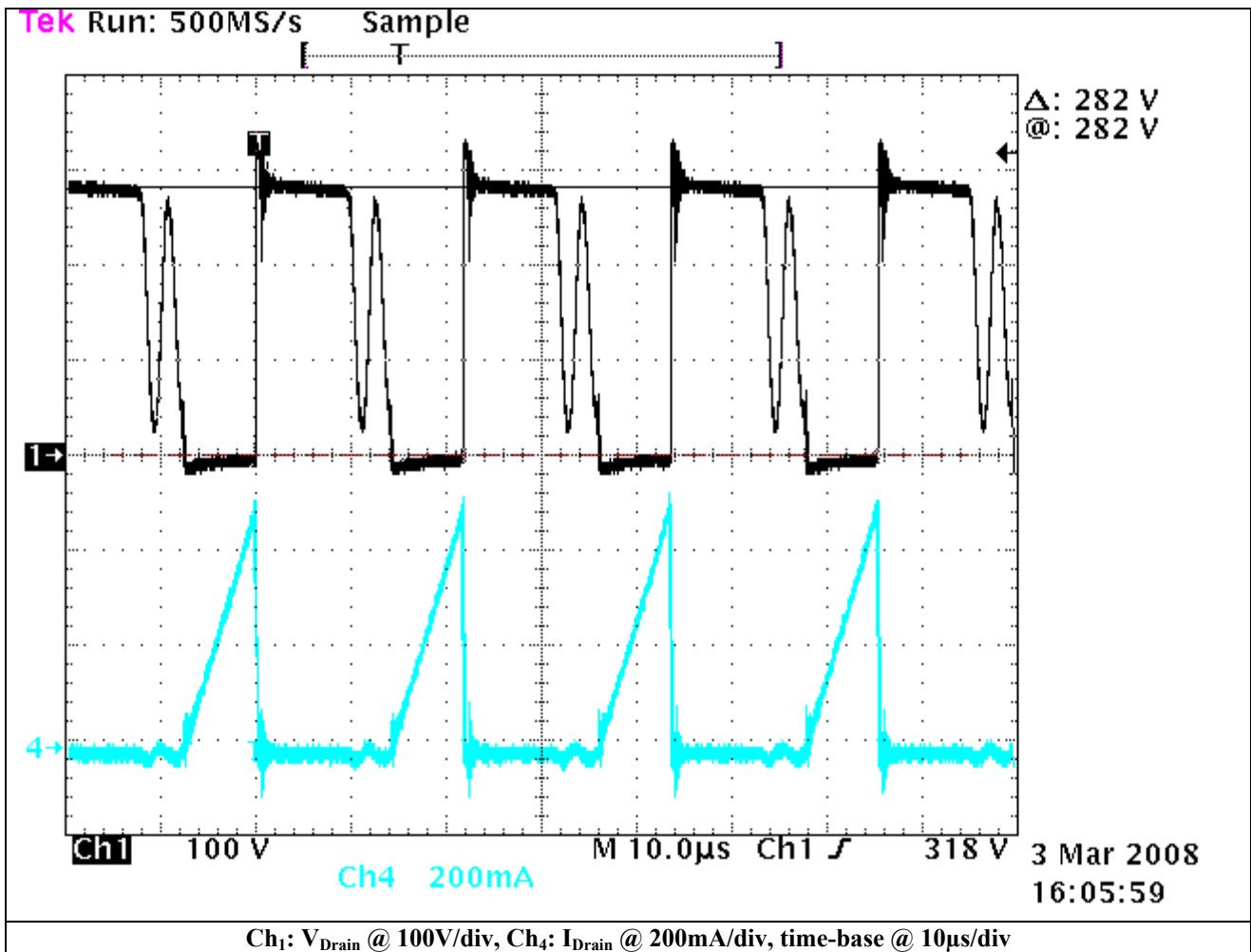

4.12.5 Result for $I_{out(max)} = 700mA @ V_{in} = 230V_{RMS}$

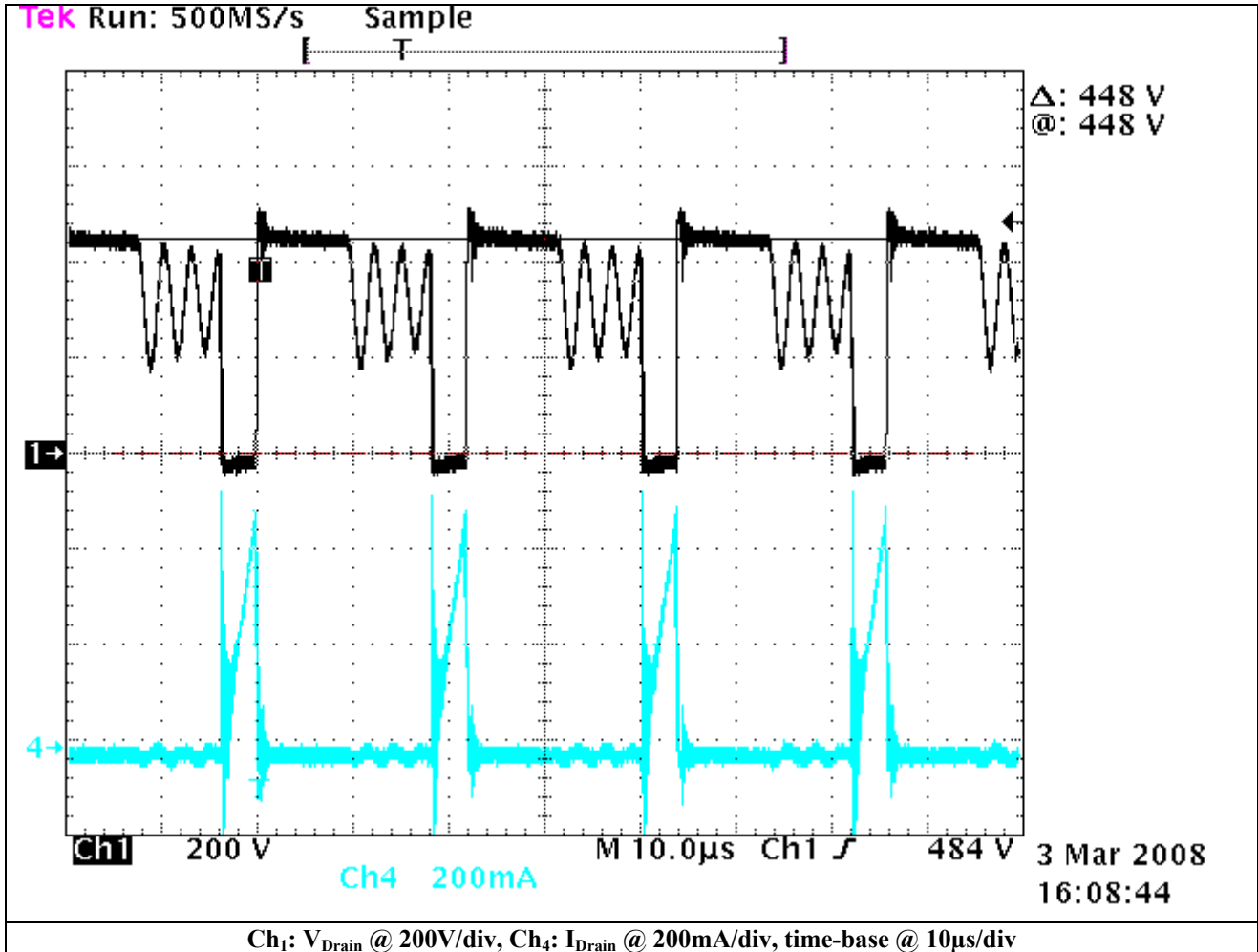

4.13 Thermal Performance

4.13.1 Test Condition and Method

The temperatures of the transformer (T1), controller (IC101), MOSFET (Q101) and the secondary rectifying diode (D201) were measured with thermocouples. The measured temperatures were monitored from start up of the PSU until a steady state was recognized. The test was done with $I_{out(max)} = 700mA/17V$ at V_{IN} of $110V_{RMS}$ and $230V_{RMS}$ respectively. $T_{amb} = 24^{\circ}C$.

4.13.2 Result for IC101 and T1 @ $V_{IN} = 110V_{RMS}$

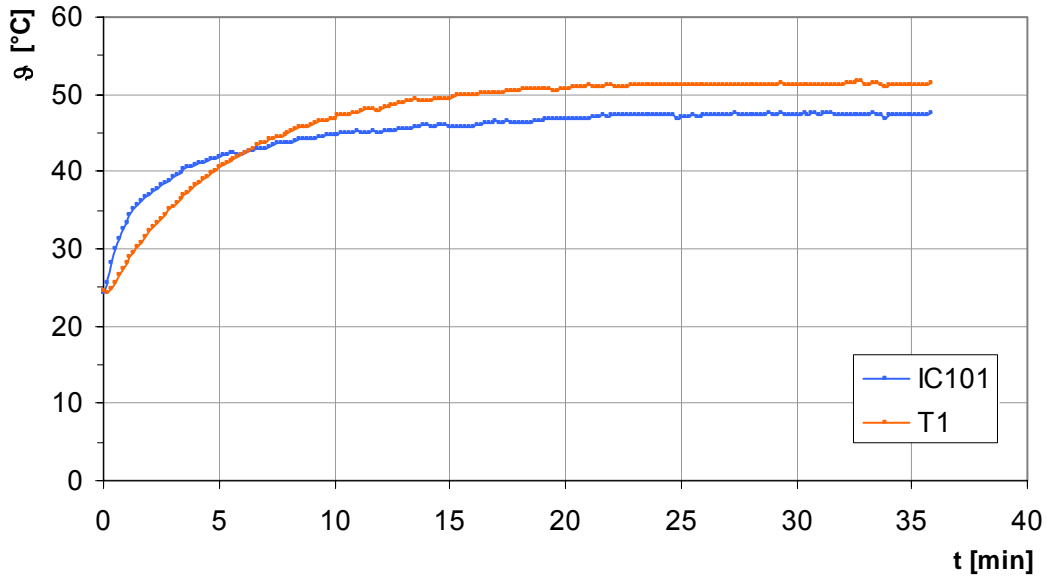

4.13.3 Result for for Q101 and D201 @ $V_{IN} = 110V_{RMS}$

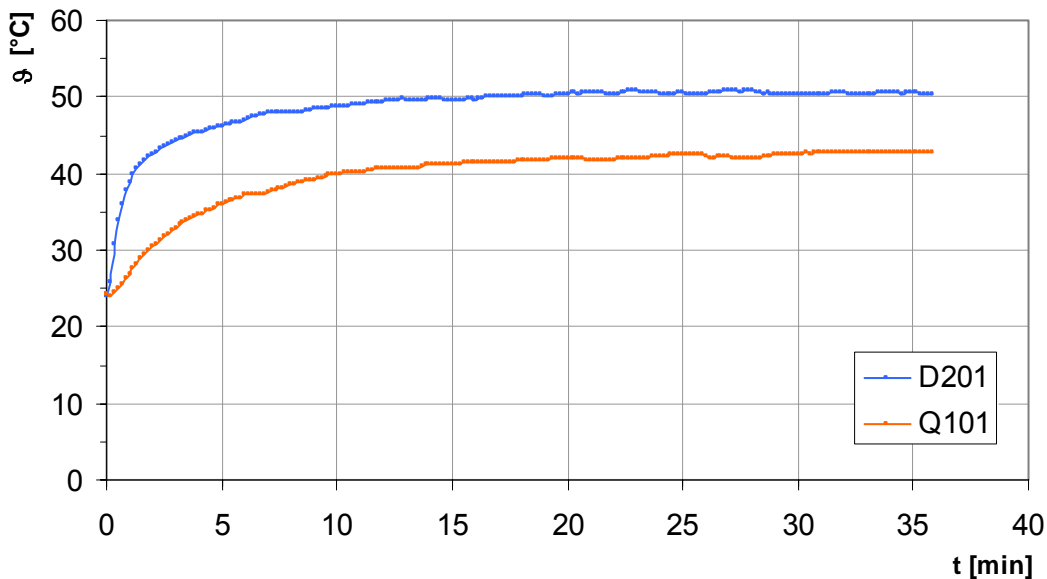

4.13.4 Result for IC101 and T1 @ $V_{IN} = 230V_{RMS}$

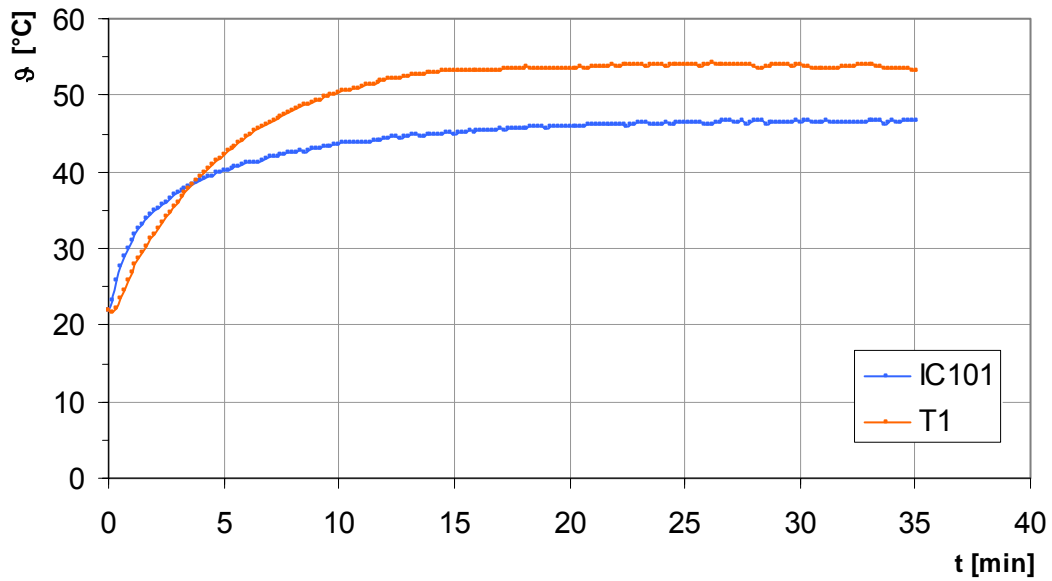

4.13.5 Result for for Q101 and D201 @ $V_{IN} = 230V_{RMS}$

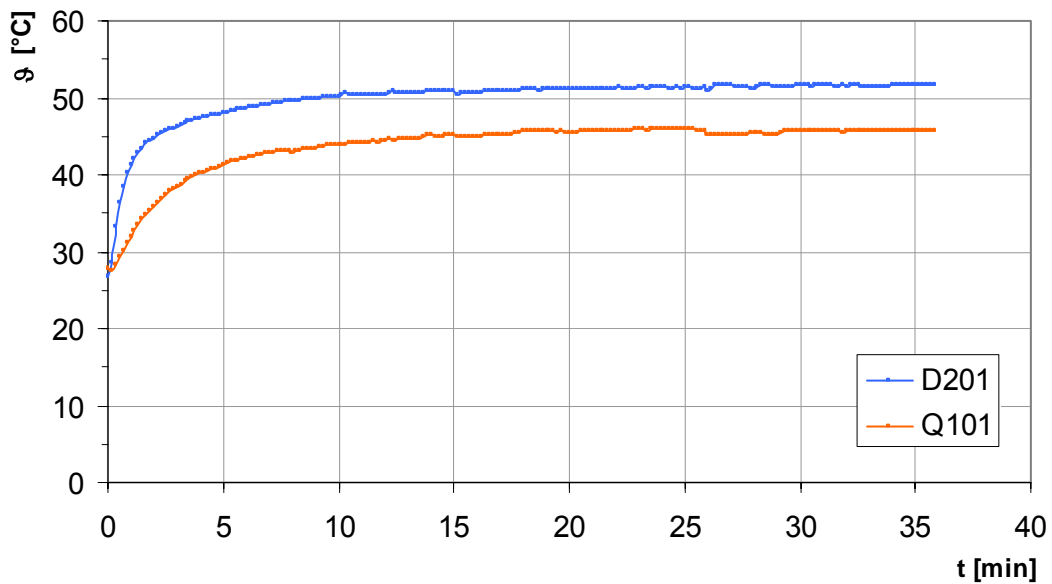

4.14 EMI Tests

4.14.1 Test Condition

The power supply was loaded with a resistor of 26.5Ω. The GND net of the output was connected to the PE conductor. Input voltages of 110V_{RMS} and 230V_{RMS} were used. The average level of the conducted EMI has been measured with the setup given in 3.0 and is compared to the Quasi-Peak and Average limits given by CISPR 22 (EN55022).

4.14.2 Result for V_{IN} = 110V_{RMS}

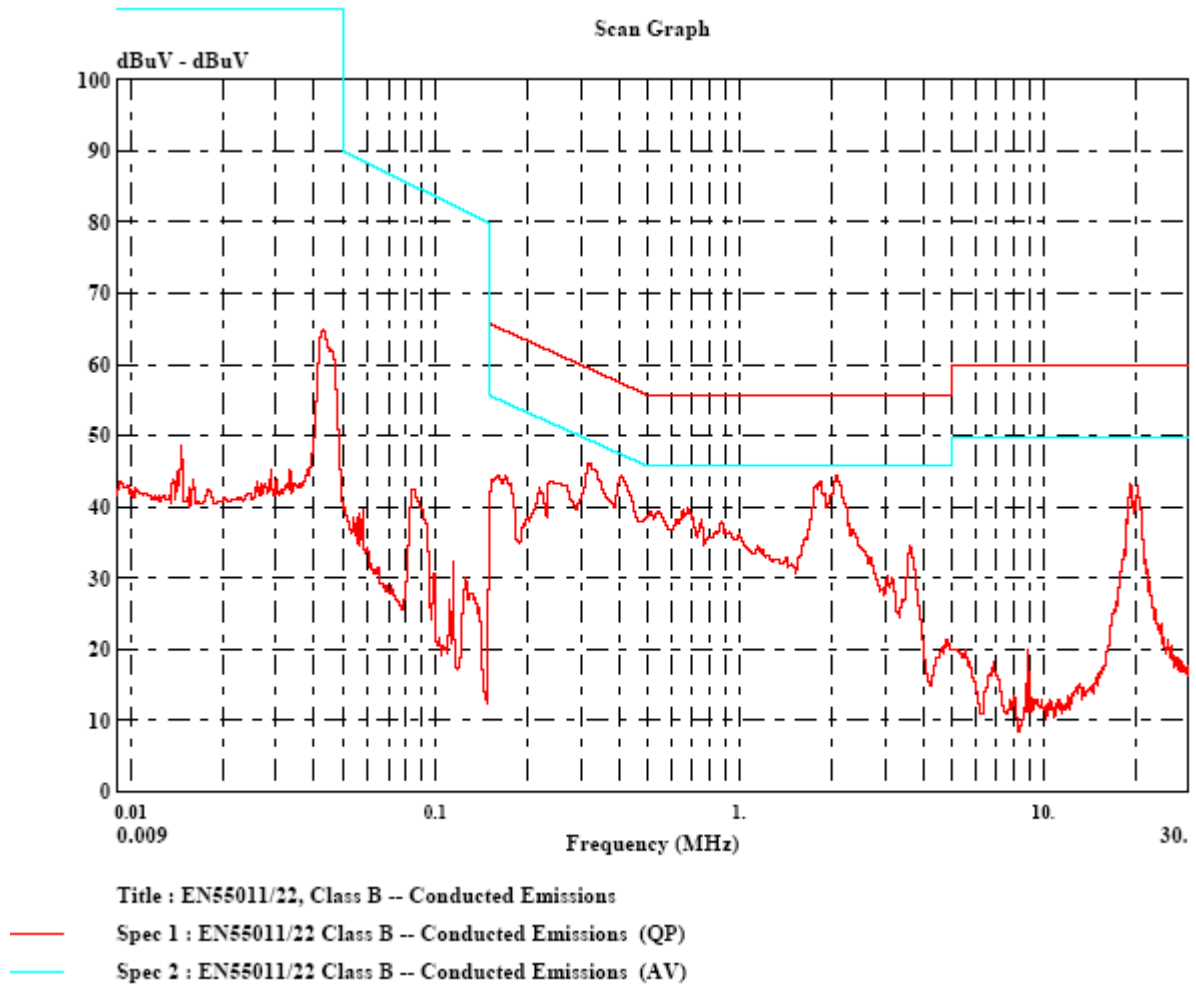

4.14.3 Result for $V_{IN} = 230V_{RMS}$

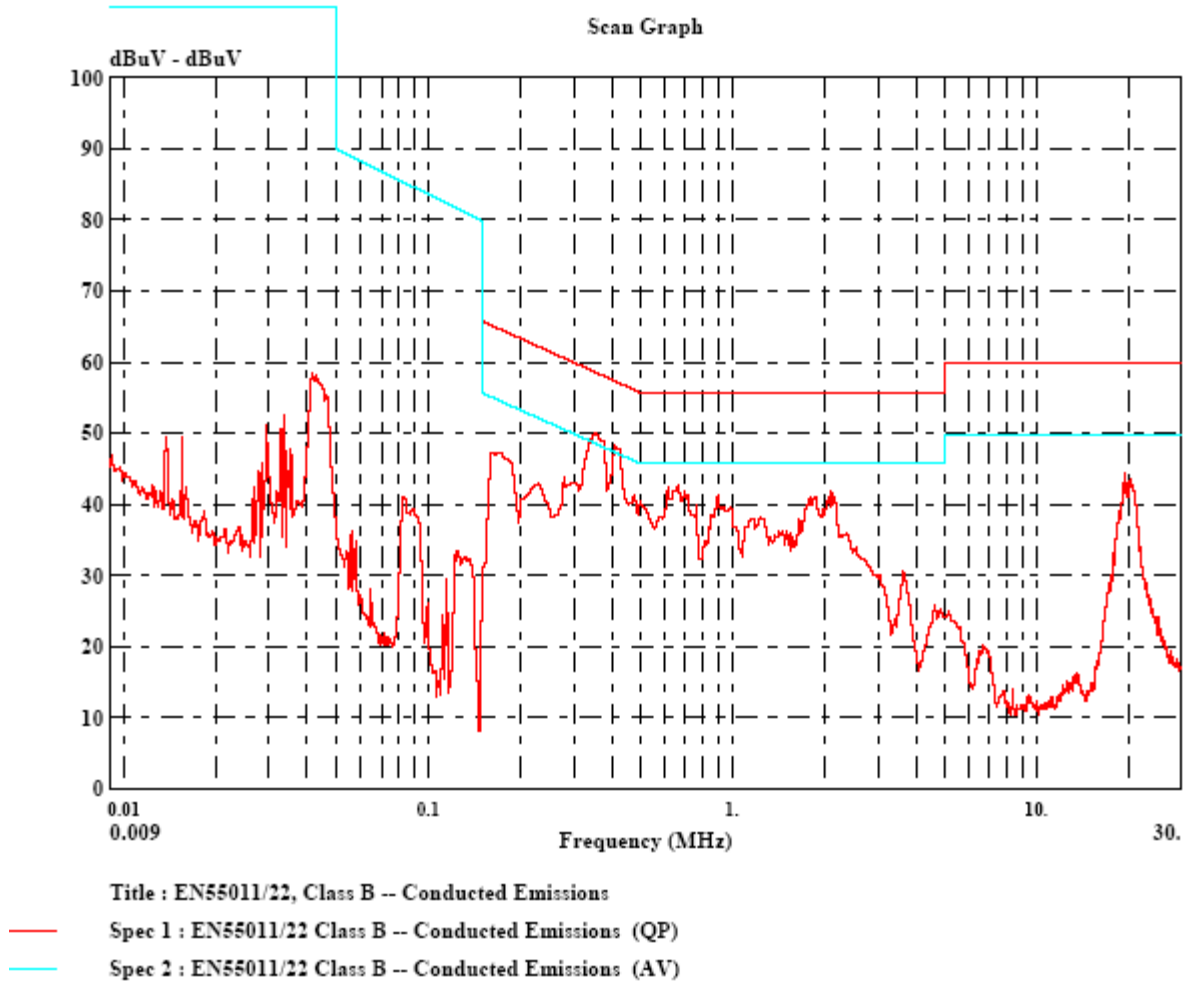

5.0 Bill of Materials and Transformer Specification

5.1 Bill of Materials

Item	Quantity	Reference	Part	Comment
1	1	CONN101	GMKDS1,5/2	Phoenix Contact, GMKDS 1,5
2	1	CONN201	MKDSN1,5/2	Phoenix Contact, MKDSN1,5
3	1	C1	2.2nF / X1Y1	Murata, DE
4	1	C101	220nF / X2	Epcos, B32922C
5	1	C102	22uF / 400V	Nichicon, VR
6	2	C103, C108	10nF / 50V	any SMD 0603
7	1	C104	68nF / 16V	any SMD 0603
8	1	C105	10uF / 25V	any SMD 1206
9	1	C106	10nF / 500V	any SMD 0805
10	1	C107	68pF / 16V	any SMD 0603
11	1	C201	22uF / 25V	Kemet, C2220C226K3RAC
12	1	D101	DF10S	Fairchild Semiconductor
13	1	D102	RS1K	Fairchild Semiconductor
14	1	D103 (not assembled)	FDLL4148	Fairchild Semiconductor
15	1	D104	RS1G	Fairchild Semiconductor
16	1	D105	MM3Z24VB	Fairchild Semiconductor
17	1	D201	ES3D	Fairchild Semiconductor
18	1	FS101	230V/250mA, time lag	Littlefuse/Wickmann, TR5
19	6	HS201, HS202, HS203, HS204, HS205, HS206 (not assembled)	Heatsink	Fischer Elektronik, FK250
20	1	IC101	FAN102MY	Fairchild Semiconductor
21	1	J101	Jumper	2-pin pin header, 100mil pitch plus shorting link
22	3	LED201, LED202, LED203	XREWHT-L1-0000-006E5	Cree, XLamp XR-E
23	1	LF101	2x39mH / 0.6A	Epcos, B82731-M
24	1	Q101	FCD4N60	Fairchild Semiconductor
25	1	Q102	BC846B	Fairchild Semiconductor
26	1	R101	100K / 2W / 5%	Any
27	2	R102, R103	2R / 0.25W / 1%	KOA, SR732BTTD2R00F
28	1	R104	10R / 0.063W / 1%	any SMD 0603
39	1	R105	100R / 0.1W / 1%	any SMD 0603
30	1	R106	200K / 0.1W / 1%	any SMD 0603
31	1	R107	39K / 0.1W / 1%	any SMD 0603
32	1	R108	7.5K / 0.1W / 1%	any SMD 0603
33	1	R109	160K / 0.1W / 1%	any SMD 0603
34	2	R110, R112	750K / 0.25W / 1%	any SMD 1206
35	1	R111	3K / 0.1W / 1%	any SMD 0603
36	1	T1	EF20/EF25 horizontal	TDK, p/n SRW20EF-X46H014 or see transformer spec

5.2 Transformer Specification

5.2.1 Winding Details

Name	Pins (Start → End)	# of Layers	Strands x Wire ø	Turns	Construction	Material
W1	3 → 1	2	1 x 0.20mm	100	perfect solenoid	CuLL
W2	9,10 → 6,7	2	2 x 0.40mm	15	bifilar	triple insulated
W3	4 → 5	1	1 x 0.15mm	39	spaced winding	CuLL

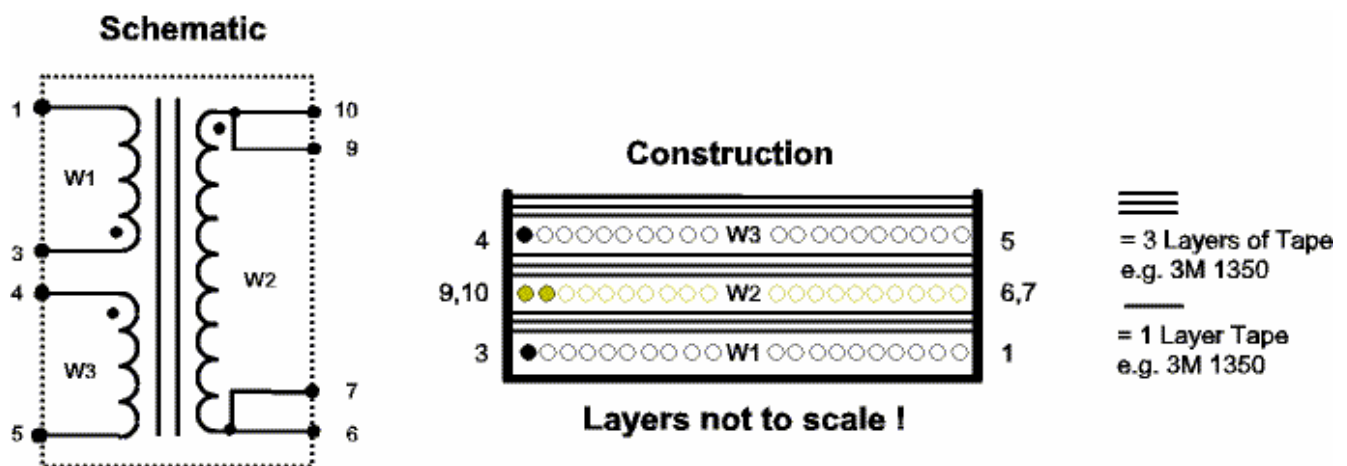

5.2.2 Electrical Characteristics

Parameter	Pins	Specification	Conditions
Primary Inductance	1 → 3	2.06mH +/- 5%	100kHz, 1000mV, all secondaries open
Leakage inductance	1 → 3	42uH maximum	100kHz, 1000mV, all secondaries short

5.2.3 Core and Bobbin

Core	E20/10/6 (EF20)
Material	PC47, TDK or equivalent
Bobbin	EF20 horizontal / 10 pins with extended creepage
Gap in center leg	approx. 0.19mm for AL of 206nH/turns ²

5.2.4 Safety

High voltage test: 3000V_{RMS} for 1 minute between primary (pins 1 to 5) and secondary (pins 6 to 10)

5.2.5 Ordering

A complete assembled transformer following this specification can be ordered directly from TDK, partnumber: SRW20EF-X46H014.

6.0 Printed Circuit Board Special Instructions

Important safety precautions:

These boards are only to be operated and handled by qualified technicians and qualified engineers who have received a specific training on the handling of high voltage laboratory boards and equipment.

DO NOT test the board without proper safety equipment, such as an isolation transformer, safety glasses and/or sun glasses.

DO NOT allow people to look directly into the LED light. LEDs are bright enough to damage your eyesight if you look directly into the light.

DO NOT allow people to touch any part of the board, both during operation and when the board is turned off. Disconnected boards can only be handled once they have cooled down and also someone has confirmed that all capacitors on the board have been fully discharged. Failure to follow these rules could result in electrical shock due to high voltages or burns due to hot parts.

DO NOT test in proximity to flammable or explosive materials.

DO NOT operate the board for extended periods at $I_{out} = 700\text{mA}$, or leave it unattended while operated.

DO NOT install the board into any product.

Operation of the board:

1. Read the safety precautions above first and follow all instructions thoroughly.
2. Make sure that jumper J101 is open, i.e. the two pins are not shorted.
3. Make sure that nothing is connected to output terminal CONN201.
4. Connect an isolated variable AC source (such as a variac) to input terminal CONN101
5. Slowly increase the AC input voltage from 0VAC to at least 85VAC (Do not exceed 265VAC). **Do not allow people to look directly at the LEDs while doing so.**
6. Confirm that the LEDs light up, however **do not** allow people to look directly at the LEDs. **Caution:** They already light up at approx. $V_{in} = 48\text{VAC}$.
7. After operation remove the AC input and confirm that the circuit is de-energized.

Selecting the output current:

The board is designed to deliver a constant output current of either 350mA or 700mA respectively. This is done by opening ($I_{out} = 350\text{mA}$) or closing/shorting ($I_{out} = 700\text{mA}$) jumper J101. During operation the LEDs get hot and you must not touch them. Due to the higher heat dissipation at $I_{out} = 700\text{mA}$ it is not recommended to operate the board for an extended time in this mode. If desired, an isolated heatsink may be applied to the backside of the board, directly beneath the LEDs.

Modification of the Board for other output currents:

The output current of the circuit is determined by a current sense resistor that is connected from source of Q101 to GND. The relationship between the output current I_o and the sense resistor R_S is expressed as:

$$R_S = \frac{0.111875 \cdot n_p}{I_o}$$

n_p is the ratio between the number of primary and secondary windings, $n_p = \frac{N_{pri}}{N_{sec}}$. In this design n_p is 6.67.

For example, R_S for an I_{out} of 100mA can be calculated as $\frac{0.111875 \cdot 6.67}{0.1} = 7.46$. From an E96 series pick 7.5Ω. Leave jumper J101 open, remove R102 and R103 and replace R102 with a 7.5Ω resistor. Higher accuracy of the calculated resistor value can be

achieved by using two resistors in parallel. In that case replace R102 and R103 with the two resistors and close (short) jumper J101. Please note that the whole design and especially the transformer design was laid-out for $P_{out(max)} = 12W$. Therefore the maximum output current is 700mA. **Important note:** The same safety precautions as written above apply!

Modification of the Board for stand alone operation:

It is possible to test the board with your own LEDs or test the performance without the on-board LEDs.

This can be done by cutting the board. First remove all cables and connections from the board and confirm that the circuit is de-energized. Then cut along the white line labeled '← Cut here for standalone operation'. After the PCB is cut into two pieces you can use CONN201 to connect your own application to the output. Input/output specifications remain the same. **Important note:** The same safety precautions as written above apply!

Connect more LEDs to the output:

Since this is a constant current output design you can drive one LED or up to six (or even more, depending on the forward voltage V_f of the LEDs). The maximum output voltage is 17V. So, if you connect 5 LEDs, the $V_{f(max)}$ of one LED should not be higher than 3.4V (2.8V for six LEDs). To connect a given number of LEDs to the output, the board must be operated stand alone, ie physically remove the actual power supply from the on-board LEDs by cutting the board (see previous paragraph). **Important note:** The same safety precautions as written above apply!

7.0 Featured Products

7.1 FAN102 Description

The FAN102 is a highly integrated PWM controller provides several features to enhance the performance of low-power flyback converters. The patented topology enables most simplified circuit designs, especially for battery charger applications. The result is a low-cost, smaller and lighter charger when compared to a conventional design or a linear transformer. The start-up current is only 10uA, which allows use of large start-up resistance for further power saving. To minimize the standby power consumption, the proprietary green-mode function provides off-time modulation to linearly decrease PWM frequency under light-load conditions. This green-mode function assists the power supply to easily meet the power conservation requirement. By using FAN102, a charger can be implemented with fewest external components and minimized cost.

7.1.1 FAN102 Features

- Constant-voltage (CV) and Constant-current (CC) Control Without Secondary-feedback Circuitry
- Green-mode Function: PWM Frequency Linearly Decreasing
- Fixed PWM Frequency at 42kHz with Frequency Hopping to Solve EMI Problem
- Cable Compensation in CV mode
- Low Start-up Current 10μA
- Low Operating Current 3.5mA
- Peak-current-mode Control in CV mode
- Cycle-by-cycle Current Limiting
- VDD Over-voltage Protection with Auto-Restart
- VDD Under-voltage Lockout (UVLO)
- Gate Output Maximum Voltage Clamped at 18V
- Fixed Over-temperature Protection with Latch
- DIP-8 and SOP-8 Package Available

7.1.2 FAN102 Block Diagram

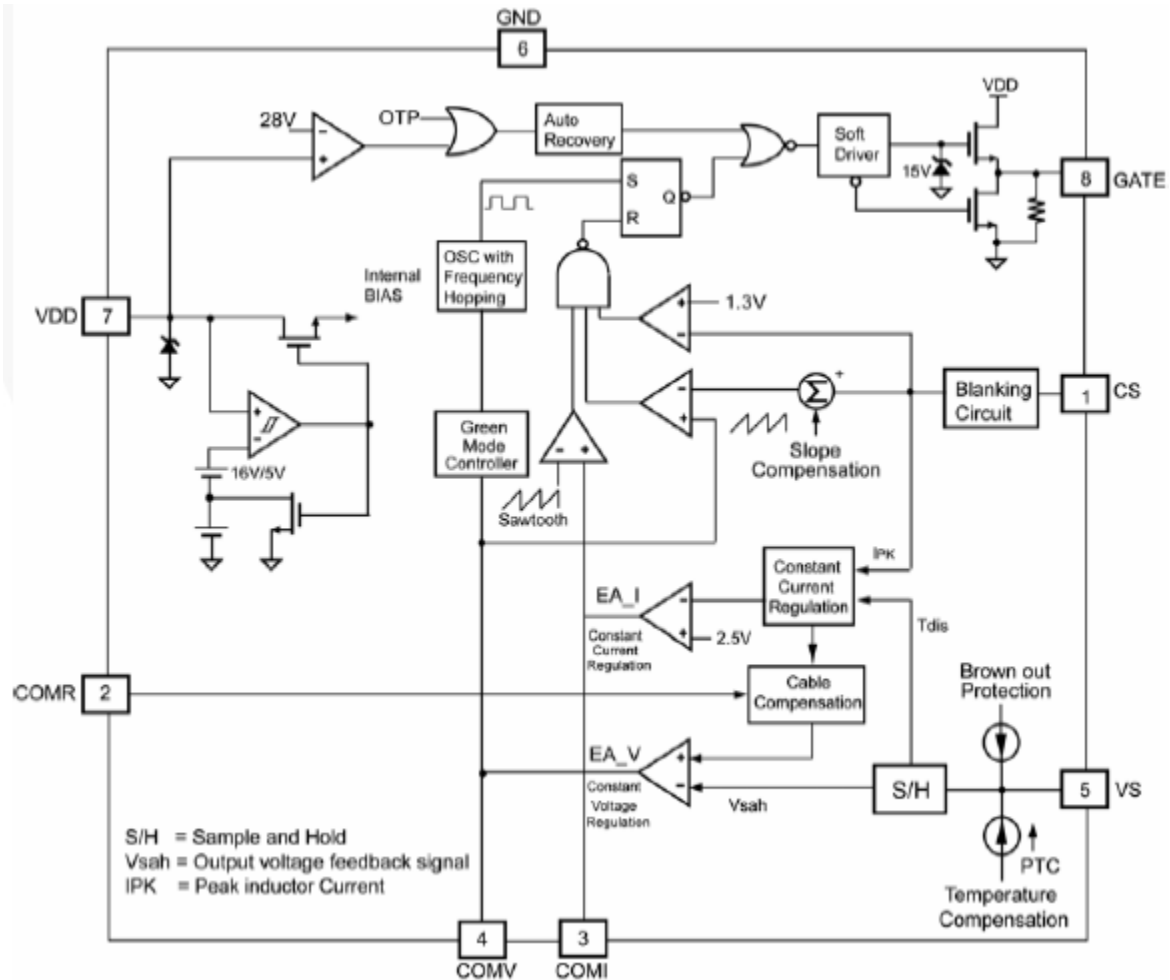







8.0 References and Resources

8.1 Application Notes

- AN-6067: Design and Application of Primary-Side Regulation (PSR) PWM Controller and EZ-Switch™

TRADEMARKS

The following are registered and unregistered trademarks Fairchild Semiconductor owns or is authorized to use and is not intended to be an exhaustive list of all such trademarks.

- | | | | |
|---|---|---|---|
| Auto-SPM™ | F-PFST™ | PowerTrench® | The Power Franchise® |
| Build it Now™ | FRFET® | PowerXS™ |  |
| CorePLUS™ | Global Power Resource SM | Programmable Active Droop™ | TinyBoost™ |
| CorePOWER™ | Green FPS™ | QFET® | TinyBuck™ |
| CROSSVOLT™ | Green FPS™ e-Series™ | QST™ | TinyLogic® |
| CTL™ | Gmax™ | Quiet Series™ | TINYOPTO™ |
| Current Transfer Logic™ | GTO™ | RapidConfigure™ | TinyPower™ |
| EcoSPARK® | IntelliMAX™ |  | TinyPWM™ |
| EfficientMax™ | ISOPLANAR™ | Saving our world, 1mW/W/kW at a time™ | TinyWire™ |
| EZSWITCH™* | MegaBuck™ | SmartMax™ | TriFault Detect™ |
|  | MICROCOUPLER™ | SMART START™ | TRUECURRENT™* |
|  | MicroFET™ | SPM® | μSerDes™ |
| Fairchild® | MicroPak™ | STEALTH™ |  |
| Fairchild Semiconductor® | MillerDrive™ | SuperFET™ | UHC® |
| FACT Quiet Series™ | MotionMax™ | SuperSOT™.3 | Ultra FRFET™ |
| FACT® | Motion-SPM™ | SuperSOT™.6 | UNIFET™ |
| FAST® | OPTOLOGIC® | SuperSOT™.8 | VCX™ |
| FastvCore™ | OPTOPLANAR® | SupreMOS™ | VisualMax™ |
| FETBench™ |  | SyncFET™ | XS™ |
| FlashWriter®* | PDP SPM™ | Sync-Lock™ | |
| FP5™ | Power-SPM™ |  | |

* Trademarks of System General Corporation, used under license by Fairchild Semiconductor.

WARNING AND DISCLAIMER

Replace components on the Evaluation Board only with those parts shown on the parts list (or Bill of Materials) in the Users' Guide. Contact an authorized Fairchild representative with any questions.

The Evaluation board (or kit) is for demonstration purposes only and neither the Board nor this User's Guide constitute a sales contract or create any kind of warranty, whether express or implied, as to the applications or products involved. Fairchild warrants that its products meet Fairchild's published specifications, but does not guarantee that its products work in any specific application. Fairchild reserves the right to make changes without notice to any products described herein to improve reliability, function, or design. Either the applicable sales contract signed by Fairchild and Buyer or, if no contract exists, Fairchild's standard Terms and Conditions on the back of Fairchild invoices, govern the terms of sale of the products described herein.

DISCLAIMER

FAIRCHILD SEMICONDUCTOR RESERVES THE RIGHT TO MAKE CHANGES WITHOUT FURTHER NOTICE TO ANY PRODUCTS HEREIN TO IMPROVE RELIABILITY, FUNCTION, OR DESIGN. FAIRCHILD DOES NOT ASSUME ANY LIABILITY ARISING OUT OF THE APPLICATION OR USE OF ANY PRODUCT OR CIRCUIT DESCRIBED HEREIN; NEITHER DOES IT CONVEY ANY LICENSE UNDER ITS PATENT RIGHTS, NOR THE RIGHTS OF OTHERS.

LIFE SUPPORT POLICY

FAIRCHILD'S PRODUCTS ARE NOT AUTHORIZED FOR USE AS CRITICAL COMPONENTS IN LIFE SUPPORT DEVICES OR SYSTEMS WITHOUT THE EXPRESS WRITTEN APPROVAL OF THE PRESIDENT OF FAIRCHILD SEMICONDUCTOR CORPORATION.

As used herein:

1. Life support devices or systems are devices or systems which, (a) are intended for surgical implant into the body, or (b) support or sustain life, or (c) whose failure to perform when properly used in accordance with instructions for use provided in the labeling, can be reasonably expected to result in significant injury to the user.
2. A critical component is any component of a life support device or system whose failure to perform can be reasonably expected to cause the failure of the life support device or system, or to affect its safety or effectiveness.

ANTI-COUNTERFEITING POLICY

Fairchild Semiconductor Corporation's Anti-Counterfeiting Policy. Fairchild's Anti-Counterfeiting Policy is also stated on our external website, www.fairchildsemi.com, under Sales Support.

Counterfeiting of semiconductor parts is a growing problem in the industry. All manufacturers of semiconductor products are experiencing counterfeiting of their parts. Customers who inadvertently purchase counterfeit parts experience many problems such as loss of brand reputation, substandard performance, failed applications, and increased cost of production and manufacturing delays. Fairchild is taking strong measures to protect ourselves and our customers from the proliferation of counterfeit parts. Fairchild strongly encourages customers to purchase Fairchild parts either directly from Fairchild or from Authorized Fairchild Distributors who are listed by country on our web page cited above. Products customers buy either from Fairchild directly or from Authorized Fairchild Distributors are genuine parts, have full traceability, meet Fairchild's quality standards for handling and storage and provide access to Fairchild's full range of up-to-date technical and product information. Fairchild and our Authorized Distributors will stand behind all warranties and will appropriately address any warranty issues that may arise. Fairchild will not provide any warranty coverage or other assistance for parts bought from Unauthorized Sources. Fairchild is committed to combat this global problem and encourage our customers to do their part in stopping this practice by buying direct or from authorized distributors.