



With such a large complement of connectors to offer, it is only fitting that you'll find an equally complete offering of **Emerson** termination tools. This line of products includes both ratchet and non-ratchet crimp tools for coaxial, modular plugs, and D-Sub connectors. In addition, you will find a wide array of cable strippers, cutters, impact and nonimpact punch down tools, and a variety of multi-meters, cable testers and termination tool kits to meet your needs.

Pro-Series 110 & 66 Impact Punch Down Tools



Pro-Series Impact Punch Down Tool
Tool includes two blades. A 66 standard with a 110 installed in the handle. It has a Twist Blade Locking Mechanism, and an adjustable "Hi-Lo" Impact Control. (Replacement Blades are interchangeable with Harris™ Blades.)

Part No.	Blade No.
24-418P	99-418 (110 only)
	99-419 (66 only)

Non-Impact Punch Down Tools



Non-Impact Punch Down Tool
for 66 & 110 type terminations (punch only) with a reversible blade, 66 on one end and 110 on the other end.

Part No.
24-410P



Non-Impact Punch Down Tool
for 66 type terminations (punch & cut) with a reversible blade, 66 punch on one end and a 66 cut on the other end.

Part No.
24-411P

Keychain Punch Down Tools



Keychain Punch Tool
for UTP/STP 110 IDC Terminations.

Part No.
30-7207



Pocket Stripper & Punch Tool
for UTP/STP 110 IDC Terminations.

Part No.
24-7742P

Modular Plug Crimping Tools



Modular Crimping Tool
that cuts, strips and terminates
4, 6, 8, & 8 Keyed Modular
Plugs. (Works on AMP™ &
Stewart™ Plugs.)

Non-Ratchet No. 24-4680P
w/ Ratchet No. 24-4680RP



Modular Crimping Tool
that cuts, strips and terminates
2, 4, 6, 8, & 8 Keyed Modular
Plugs. (Will not work on
AMP™ RJ-45 Plugs.)

Non-Ratchet No. 24-4681P
w/ Ratchet No. 24-4682P



Deluxe Modular Crimping Tool
that cuts, strips and terminates
2, 4, 6, 8, and 8 Keyed, 10, DEC 4
& 6 and 4 Conductor Handset
Plugs. (Works on AMP™
RJ-45 Plugs only.)

w/ Ratchet No. 24-7865P



Economy Modular Crimping Tool
for RJ-11/12 Plugs. Cuts, strips
and terminates 2, 4 and 6 Pin
Modular Plugs.

Blister No. 24-7746P

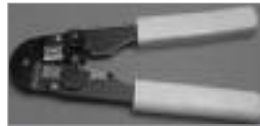

**Economy Modular Handset
Crimping Tool**
for RJ-22 Plugs. Cuts, strips and
terminates 4 Pin Handset Plugs.

Blister No. 24-7749P



**Economy Modular RJ-45
Crimping Tool**
that cuts, strips and terminates
8 & 8 Keyed Modular Plugs.

Blister No. 24-7748P

Wire Cutters & Strippers



Heavy Duty Cable Cutter
for cutting RG-8 Cable and Multi-
Conductor Cable up to .500".

Blister No. 24-7378P



5" Cutter & Stripper
Thin profile,
Carbon Steel

Blister No. 24-7376P



All Purpose Utility Tool
Wire Stripper, Cutter, Plier &
Crimper, strips 10 to 18 AWG Wire

Blister No. 24-7371P



5" Cutter Economy Stripper
Adjustable control, Return
Spring, Carbon Steel

Blister No. 24-7375P

D-Sub Crimping & Termination Tools



D-Sub Full Cycle Ratchet Crimping Tool
Crimps 10-22 AWG Non-Insulated Open Barrel Connectors, D-Sub & V.35 Contacts.

Blister No. 24-8644P
Replacement Die No. 99-8644



D-Sub Full Cycle Ratchet Crimping Tool with Tension Adjustment Wheel, crimps 18-22 & 24-30 AWG, Non-Insulated Open Barrel Connectors, D-Sub Contacts.

Blister No. 24-8645P



D-Sub Crimping Tool for Precision Machined Contacts, 4 Way Indent, Crimps 20-26 AWG with Built-in Contact Locator.

Blister No. 24-8643P



Insulated Terminal Ratchet Crimping Tool Crimps 10-22 AWG fully insulated terminals in an ovalized crimp.

Blister No. 24-8622P
Replacement Die No. 99-8622

See our wide selection of D-Sub components on pages 26-29.



D-Sub Non-Ratchet Crimp Tool Crimps Non-Insulated Open Barrel Connectors & Contacts.

Blister No. 24-7373P



Automatic Trigger Stripper for stripping Stranded Multi-conductor Cable and Solid Conductor Cable, 14-22 AWG.

Blister No. 24-4550P



4" Universal UTP Stripping Tool for Round or Flat Wire and UTP Cable from 3.5 mm-9 mm max. Even irregular outshape of insulation can be put into the V and U slots. Strips 2, 4, 6 & 8 Conductor. Flat or Round, Solid or Stranded Cable.

Blister No. 24-7740P



Automatic Wire Stripper Designed for Radio, TV & Computer and Telephone cabling applications to cut and strip insulation automatically.

Blister No. 24-4700P
size: 0.5-2.0 mm

Blister No. 24-4710P
size: 1.0-3.2 mm

D-Sub Insertion Tools



Standard D-Sub Insertion & Extraction Tool

Part No.
40-9865



High-Density D-Sub Insertion & Extraction Tool

Part No.
40-9427T

'Compression Connector Crimping Tools



Compression Crimp Tool
For RG-59 & RG-6 Snap-N-Seal® compatible
20.3mm (F) Connectors..

Blister No. 24-7713P



All-In-One Adjustable Ratchet Crimp Tool
for all types of BNC, F and RCA Compression
Connectors

Blister No. 24-7714P

New!

Economy 'F' Series Crimping Tools



Economy Hex Crimping Tool
for RG-6 & RG-59. Economy
packaged in non-retail box.

Boxed No. 24-7709H



Standard Crimping Tool
for RG-6 & RG-59. Economy
packaged in non-retail box.

Boxed No. 24-7700



Standard Crimping Tool
for RG-6 & RG-59. Includes (10)
No. 25-7050 'F-59A' Connectors
with attached 1/8" Ring.

Blister No. 24-7700P

Heavy Duty 'F' Hex Crimping Tools



Deluxe Hex Crimping Tool
for RG-8, 11 & 213.
Hex Sizes: .10", .322", .448"

Boxed No. 24-7711P



Deluxe Hex Crimping Tool
for large O.D. Cables, RG-6,
RG-11 & UHF RG-8.
Hex Sizes: .102", .359", .406"

Blister No. 24-7712P



Deluxe Hex Crimping Tool
for large O.D. Cables, RG-6 &
RG-59. Economy packaged in
non-retail box.
Hex Sizes: .255", .322"

Boxed No. 24-7710



Deluxe Hex Crimping Tool
for RG-6 & RG-59, retail packaged
with (10) No. 25-7030 'F-59ALM'
Connectors with attached 1/2"
Gripped Ring. Hex Sizes: .255", .322"

Blister No. 24-7710P

Universal Coaxial Crimping Tools



Universal Ratchet Crimping Tool
for BNC, TNC & Mini UHF.
Five crimp sizes for Pins &
Connector Ferrules. Crimps
2 & 3 piece Connectors.
Features adjustable crimp
pressure and quick release
safety latch.

Blister No. 24-9960P

Hex Size	Use For
.068"	Center Conductor (16-22 AWG)
.110"	Center Conductor (10-13 AWG)
.213"	Ferrule for RG-58/59TFE/141/303/55/142/233/400
.255"	Ferrule for RG-59/62/140/210/Belden 8279
.324"	Ferrule for RG-6/143/212/222/Belden 8281,9231,9141

Replacement Frame & Dies:

Part No.	Description	Hex Sizes
99-DC-5	Die - 2 pc BNC & TNC	.320", .385"
99-N-8	Die - 'N' (RG-8 Hex)	.110", .405
99-U-8	Die - 'UHF' (RG-8 Diamond)	.110", .405
99-9960	Die - BNC, TNC & MiniUHF	See 24-9960P sizes above
*99-9960F	Replacement Frame	-----



Blister No.
24-8866P

'F' Ratchet Crimping Tool
Crimps RG-59, RG-6, and
RG-Quad Shield 'F' type
CATV connectors. Features
adjustable crimp pressure
and quick release safety
latch.

Hex Sizes: .255", .324", .354"



Blister No.
24-8865P

**Ratchet Crimping Tool for
Twin-Ax**
9" Ratchet Crimp Tool.
For Twin-Ax Ferrule and
Contacts. Features
adjustable crimp pressure
and quick release safety
latch.

Hex Sizes: .429", .075", .075"

*Note: All dies listed on this page are interchangeable with this Tool Frame.

Standard Series Ratchet Crimping Tools



This series of tools offers a wide selection of interchangeable dies, a high quality steel frame with a full cycle ratchet mechanism and a quick release safety latch. All are blister packaged for retail display.

Tool Part No.	Cable Size	Description	Hex Sizes	Die Part #
24-328P	RG-58, RG-161, RG-178, RG-174, RG-182, RG-188, RG-316	SMA, SMB, Fiber	.043", .069", .100" .128", .151", .210"	99-328
24-8856P	RG-6, RG-8 RG-59, RG-62	Crimps BNC-TNC 3 pc. Connectors with standard rings	.390", .275", .065"	99-8856
24-8857P	RG-58, RG-58AU RG-139, RG-185 RG-188, RG-316	Crimps BNC-TNC 3 pc. Connectors with standard rings	.235", .128", .065"	99-8857
24-8858P	RG-58, RG-58AU, RG-59	Crimps BNC-TNC Teflon, RG-62 Teflon & 3 pc. Connectors also crimps 1/2" ring 'F' Connectors	.325", .210", .065"	99-8858
24-8859P	RG-59, RG-62 Belden 8281	Crimps BNC-TNC 2 & 3 pc. Connectors with standard & dual crimp rings	.325", .258", .066"	99-8859
24-8789P	RG-58, RG-59, RG-62, RG-58TFE, RG-59TFE, RG-62TFE	Crimps BNC & TNC 2 & 3 pc. Connectors with standard crimp rings by AMP, Kings and Amphenol	.257", .210", .060"	99-8789
24-9858P	RG-58, RG-59TFE	Crimps 2 pc. BNC & TNC Connectors	.320", .211"	99-9858
24-9859P	RG-59, RG-62	Crimps 2 pc. BNC & TNC Connectors	.320", .250"	99-9859
24-9958P	RG-58, RG-58TFE, RG-59TFE, RG-141TFE, RG-142, RG-223, RG-400 RG-303, RG-55	Crimps 3 pc. BNC-TNC & Mini-UHF Connectors	.213", .060"	99-9958
24-9959P	RG-59, RG-62, RG-450	Crimps 3 pc. BNC-TNC Proflex, RG-8X & Mini-UHF Connector	.255", .060"	99-9959
24-9912P	RG-122, 180, 34M RG-195, 8218, RG-174 188, RG-179, 187, 316	Crimps 3 pc. BNC-TNC Connectors	.184", .060"	99-9912
24-8644P	Open Barrel Crimper V.35 Contacts, 10-22 AWG	Crimps open barrel Non-insulated Connectors D-sub, Mini pins & sockets	-----	99-8644
*99-frame-9"	-----	9" Frame for Standard Ratchet Tools	-----	

*Note: All standard series dies on this page are interchangeable with this Tool Frame.

Offset Ratchet Crimping Tools



Ratchet Crimping Tool
for 2- & 3-Piece Crimp Connectors.
Offset die with 3 crimp sizes for Pins & Connector Ferrule including 'F' Connectors and RG-58 & 59TFE Cable. Features adjustable crimp pressure and quick release safety latch.

Part No.

24-8861P

Hex Size Use For

.060"	Center Conductor
.210"	Ferrule for RG-58/141/303/55/142/233/400
.320"	Ferrule for RG-6/143/212/222/Belden 8281,9231,9141



Ratchet Crimping Tool
for 3-Piece Crimp Connectors.
Offset die with 3 crimp sizes for Pins & Connector Ferrule including RG-58 & 59TFE Cable. Features adjustable crimp pressure and quick release safety latch.

Part No.

24-8860P

Hex Size Use For

.060"	Center Conductor
.210"	Ferrule for RG-58/141/303/55/142/233/400
.255"	Ferrule for RG-59/62/140/210/Belden 8279

Self-Adjusting Coax Strippers



2-Step Cable Stripper
with self-adjusting replacement blades for RG-6, 58, 59 & 62.

Blister No.	Blades No.
24-7732P	99-7732B



3-Step Cable Stripper
with self-adjusting replacement blades for RG-6, 58, 59 & 62.

Blister No.	Blades No.
24-7733P	99-7733B

3-Step Coax Strippers



3-Step Cable Stripper
with adjustable replacement blades for standard & Teflon RG-58, 59 & 62.

Blister No.	Blades No.
24-7737P	99-7737



3-Step Cable Stripper
with adjustable replacement blades for standard & Teflon RG-59, RG-6 & Belden 8281.

Blister No.	Blades No.
24-7738P	99-7738



3-Step Cable Stripper
with non-adjustable replacement blades RG-8, 11 & 213.

Blister No.	Blades No.
24-7739P	99-7739

2-Step Coax Strippers

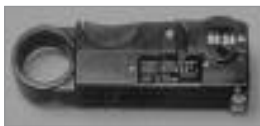

2-Step Cable Stripper
with adjustable replacement blades for standard & Teflon RG-58, 59 & 62.

Blister No.	Blades No.
24-7735P	99-7735



2-Step Cable Stripper
with adjustable replacement blades for standard & Teflon RG-59, RG-6 & Belden 8281.

Blister No.	Blades No.
24-7736P	99-7735



2-Step Cable Stripper
with non-adjustable replacement blades RG-8, 11 & 213.

Blister No.	Blades No.
24-7731P	99-7731B



Universal 2-Step Cable Stripper
with adjustable replacement blades for RG-6, 58, 59 & 62.

Blister No.	Blades No.
24-7734P	99-7734



2-Step Cable Stripper
with adjustable replacement blades for RG-6, 58, 59 & 62. Poly bagged.

Part No.
VSCST-1B

Hand Crimp Tool

Precision Astro Tool hand crimping tool makes cable assembly fast and easy. Crimping tool features interchangeable steel dies. Ratchet action of tool controls crimping operation for precise uniform ferrule crimps.



CONNECTOR TYPE	CABLE TYPE	PREFERRED DIE SET	CRIMP DIMENSIONS
MCX SMA SMB SMC	RG-178/U RG-196/U	141-0000-901	Hex = .105 (2.67) Width = .325 (8.26)
MCX SMA SMB SMC 75 Ohm SMB	RG-161/U, RG-174/U RG-179/U, RG-187/U RG-188/U, RG-316/U LMR-100	141-0000-902	Hex = .128 (3.25) Width = .400 (10.16)
	RG-188 DS, RG-316 DS RG-179 DS, RG-187 DS, BELDEN 735A	141-0000-905	Hex = .151 (3.83) Width = .400 (10.16)
MCX SMA SMB	RG-58/U RG-141/U RG-303/U RG-55/U RG-142/U RG-223/U RG-400/U LMR-195 LMR-200	141-0000-903	Hex = .213 (5.41) Width = .375 (9.52)
SMA 75 Ohm SMB	LMR-240, RG-59	141-0000-925	Hex = .255 (6.48) Width = .400 (10.16)
N Type	RG-316/U, 316 DS	141-0000-927	Hex = .160 (4.06) Width = .400 (10.16)

*Economy Hand Crimp Tool also available with four hex sizes in one tool page 191.

Ordering Information for Crimping Tool

PART NO.	DESCRIPTION	ASTRO TOOL P/N
144-0000-900	Frame Only	620175
141-0000-901	Single Hex Die	620932
141-0000-902	Single Hex Die	620419
141-0000-903	Single Hex Die	620676
141-0000-905	Single Hex Die	630055
141-0000-925	Single Hex Die	620938
141-0000-927	Single Hex Die	620297

Crimp Dies for Contacts

use with 144-0000-900

CONNECTOR TYPE	PREFERRED DIE SET	CRIMP STYLE
SMB Cross Hole Style Body 50 Ohm Only	141-0000-911	Double Diamond
Mini 75 Ohm SMB, MCX 75 Ohm Cross Hole Style Body	141-0000-924	Double Diamond

Economy Hand Crimp Tool

Hand crimp tool and die set includes all hex sizes necessary for subminiature connector applications. Ratchet tool action insures a complete crimp every time.



PART NO.	DESCRIPTION	HEX	WIDTH	CONNECTOR TYPE
140-0000-952	Hand Crimp Tool Frame Only			
140-0000-953	Die for .047" dia. flexible cable; RG-178, RG-316, RG-316 DS and Contact Crimp w/stop	.105 (2.67)	.250 (6.35)	MMCX*, MCX
		.128 (3.25)	.250 (6.35)	
		.151 (3.83)	.250 (6.35)	
		Diamond Crimp for .038 (0.96) Dia. Contact		
140-0000-951	Die for RG-178, 316, 316 DS, 58, 142, LMR-100, LMR-195, LMR-200	.105 (2.67)	.390 (9.91)	MCX, SMB, SMC, SMA, 75 OHM SMB
		.128 (3.25)	.390 (9.91)	
		.151 (3.83)	.390 (9.91)	
		.213 (5.41)	.390 (9.91)	
140-0000-955	Die for RG-179, 179 DS, 735A, RG-59, LMR-240	.128 (3.25)	.390 (9.91)	75 Ohm MCX, SMA Mini-75 Ohm SMB
		.151 (3.83)	.390 (9.91)	
		.178 (4.52)	.390 (9.91)	
		.255 (6.48)	.390 (9.91)	

*Use 140-0000-951 for MMCX straight cabled bulkhead jack body crimp.

3-Piece SMA - Contact Hand Crimp Tool

Quick and secure crimp assembly of SMA contacts to all cable sizes used by the 3-piece SMA connector line is possible. The crimp tool is used in conjunction with 141-0000-907 turret positioner which positions the crimp location on the contact with no user setup required. Set the selector to the appropriate crimp size, insert contact and cable into tool and squeeze handles of tool. A complete and accurate crimp is obtained every time, with no partial crimp. A ratchet insures a complete cycle of the tool. Automated tooling information is available on request.



PART NO.	DESCRIPTION	ASTRO TOOL PART NO.	MILITARY PART NO.
144-0000-910	Frame Only	615708	M22520/1-01
141-0000-907	Positioner	650027	N/A

3-Piece SMB, MCX - Contact Hand Crimp Tool

The micro contact crimp tool provides an accurate eight indent crimp on small diameter contacts used in the 3-Piece SMB and MCX connectors. This crimp tool is used with the 140-0000-971 Variable Positioner. Set the crimp size in the adjustment window and position the variable locator to obtain an accurate repeatable crimp on the contact.



PART NO.	DESCRIPTION	ASTRO TOOL PART NO.
140-0000-970	Frame Only	612118-1
140-0000-971	Positioner	N/A

MMCX Assembly/Decoupling Tool

This tool will assemble the end cap to a standard right angle MMCX plug connector in the field. Simply insert connector and cap into tool cavity, then turn handle to swage the cap into place. The slotted end of the tool can be used to disengage a right angle MMCX plug from a mating receptacle.



PART NO.

141-0000-910

MCX Right Angle Plug Assembly Tool

This quick and easy to use tool will press the end cap onto standard right angle MCX plug connectors. Simply insert the connector and cap into the staking nest and a light squeeze of the handles will swage the cap into place.

The jaw tips are shaped to grip a right angle MCX plug body for insertion or disengagement to a mating receptacle. The jaws are hardened steel and the handles are cushioned to minimize stress to the user. For use with all cable groups except RG-58.



PART NO.

141-0000-908

“C” Spring Compression Tool

For assembly of SMA Coupling Nut



PART NO.

141-0000-904

SMA Knurl Mount Assembly Tool

The Knurl Mount SMA Spark Plug Connectors can be pressed into position using this thread-on fixture designed for low volume lab use.



PART NO.

140-0000-954

SMB Plug Removal Tool

Reaches in to disengage SMB connectors in high density packaging applications.



PART NO.

140-0000-956

SMK (2.92mm) Tools

Accurate assembly of the SMK cabled connectors is obtained with the tools listed below. Industry standard devices are used if possible for customer convenience and tool compatibility.

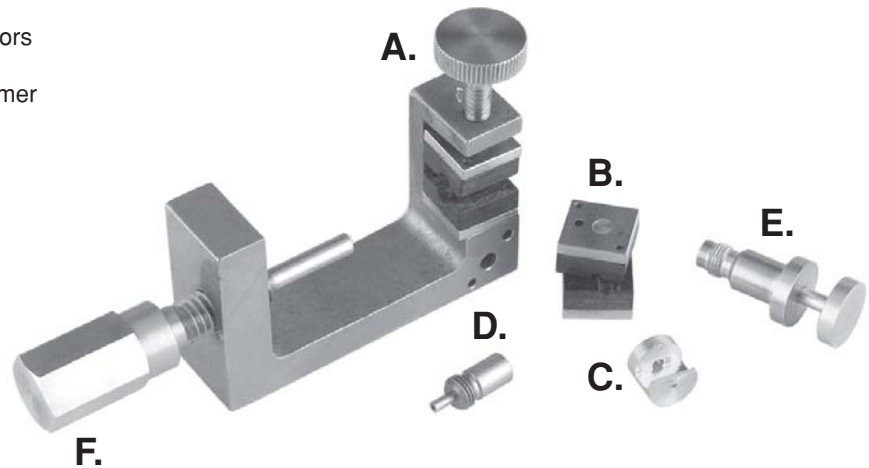

ITEM	PART NO.	DESCRIPTION
A	140-0000-962	Semi-Rigid Cable Vise (does not include inserts (B) or Vise Stop (F))
B	140-0000-964 140-0000-965	Cable Clamp Inserts, .086 Semi-Rigid Cable Clamp Inserts, .141 Semi-Rigid
C	140-0000-960 140-0000-961	Contact Soldering Tool, .086 Plug Contact Soldering Tool, .141 Plug
D	140-0000-958 140-0000-959	Body Soldering Tool, .086 Plug Body Soldering Tool, .141 Plug
E	140-0000-957	Bead Assembly Tool, Semi-Rigid Plugs, All Cables
F	140-0000-968	Vise Stop, (2.92mm)

Self-Adjusting Blades (Replaceable Cassette)



- 2-step Cable Stripper
- w/replacement cassettes
- for RG-6, 58, 59 and 62

PART NO.	DESCRIPTION
24-7732P	Tool
99-7732B	Replacement Cassette



- 3-step Cable Stripper
- w/replacement cassettes
- for RG-6, 58, 59 and 62

PART NO.	DESCRIPTION
24-7733P	Tool
99-7733B	Replacement Cassette

Blade Series (w/adjustable blades) Two Step Cut



Universal Coax Stripper

- Adjustable blades for RG-6, 58, 59 and 62
- w/switchable V-block
- does 2 cuts in 1 motion

PART NO.	DESCRIPTION
24-7734P	Tool
99-7734	Replacement Blades (set of 2)



Coax Stripper for Standard and Teflon

- Adjustable blades for RG-58, 59 and 62
- does 2 cuts in 1 motion

PART NO.	DESCRIPTION
24-7735P	Tool
99-7735	Replacement Blades (set of 2)



Coax Stripper for Standard and Teflon

- Adjustable blades for RG-6, 58, 8281
- does 2 cuts in 1 motion

PART NO.	DESCRIPTION
24-7736P	Tool
99-7735	Replacement Blades (set of 2)

Three Step Cut



Coax Stripper for RG-58, 59, 62

- adjustable blades
- does 3 cuts in 1 motion

PART NO.	DESCRIPTION
24-7737P	Tool
99-7737	Replacement Blades (set of 3)



Coax Stripper for RG-59, RG-6, 8821

- does 3 cuts in 1 motion

PART NO.	DESCRIPTION
24-7738P	Tool
99-7737	Replacement Blades (set of 3)



Coax Stripper for RG-8, 11, 213

- does 3 cuts in 1 motion

PART NO.	DESCRIPTION
24-7739P	Tool
99-7739	Replacement Blades (set of 3)

Prestige™ Ratchet Crimp Tools Adjustable Standard Series

- Long Life Full Cycle Ratchet Mechanism
- High Quality Steel Construction

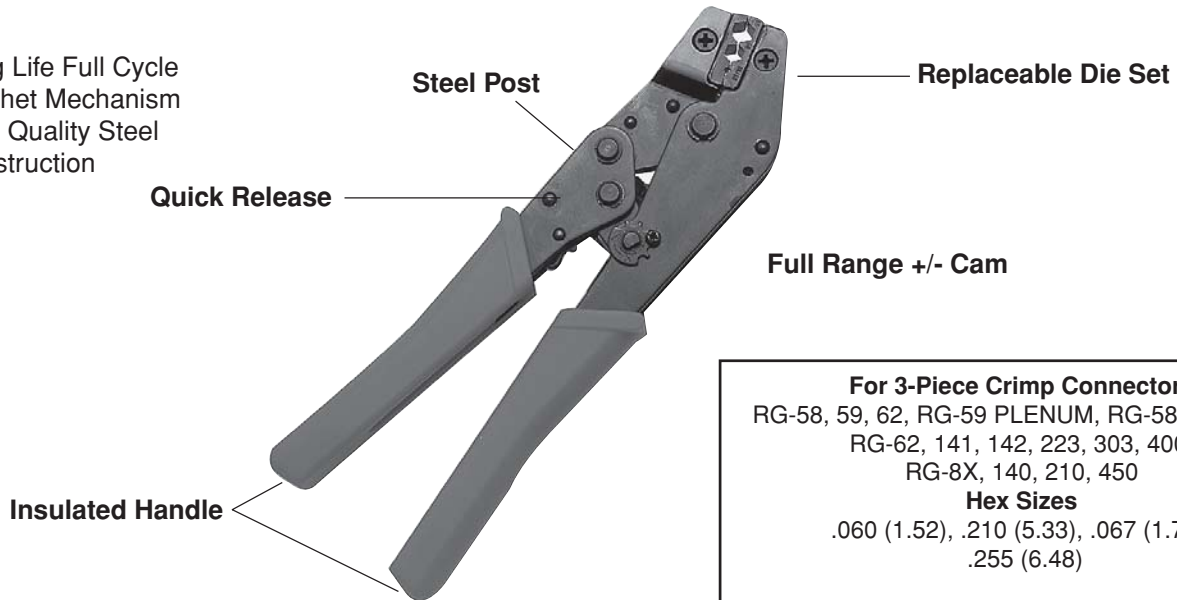

For 3-Piece Crimp Connectors
 RG-58, 59, 62, RG-59 PLENUM, RG-58 PLENUM,
 RG-62, 141, 142, 223, 303, 400,
 RG-8X, 140, 210, 450
Hex Sizes
 .060 (1.52), .210 (5.33), .067 (1.70),
 .255 (6.48)

PART NO.	DESCRIPTION
24-8860P	Tool
99-8860	Replacement Die

Prestige™ Universal Crimp Tool

- Adjustable Crimp Force
- With five hex sizes in one tool!
- Crimps 2 and 3 Piece Connectors



CRIMP HEX	CABLE
.068 (1.73)	Center Conductor 16 to 22 AWG
.100 (2.54)	Center Conductor 10 to 13 AWG
.213 (5.41)	RG-55, 58, 141, 142, 223, 203, 400, RG-59TFE
.255 (6.48)	RG-59, 62, 140, 210, Belden 8279
.324 (8.23)	RG-6, 142, 212, 222, Belden 8281, 9231, 9144

PART NO.
24-9960P

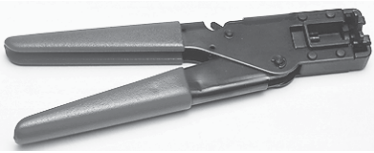

Compression Crimp Tool

For “F” (CATV) type weatherproof compression connectors (RG-59 and RG-6 single, Tri/Quad series)

PART NO.
24-7713P



“F” Ratchet Crimp Tool

9” inch ratchet crimp tool for RG-59, RG-6, RG-Quad
.255, .324, .354 Hex size
(for F Series CATV connectors)

PART NO.
24-8866P



Deluxe Crimp Tool for RG-6, 59
.322, .255 Hex Size

PART NO.
24-7710P



Deluxe Crimp Tool for RG-6, 11, 213
.448, .322, .100 Hex Size
(for F series connectors)

PART NO.
24-7711P



Deluxe Crimp Tool for RG-6, 11, UHF-8
.406, .359, .102 Hex Size
(for BNC, N and UHF connectors)

PART NO.
24-7712P

Boxed “F” Series Crimp Tool with Connectors



Deluxe Crimp Tool for RG-6, 59
comes with 10 pieces 25-7032
connectors w/1/2” crimp ring
.322, .255 Hex Size

PART NO.
24-7710P

PART NO.	CABLE SIZE	DESCRIPTION	HEX SIZE	REPLACEMENT DIE
24-302P	BELDEN 8281	2 pc. BNC & TNC	.350, .288	99-DC-3
24-310	RG-8	UHF	.405, .110	99-U-8
24-312	RG-58, 59, 8x, 450	N	.255, .210, .100	99-N-1
24-313	RG-8	N	.429, .100, .080	99-N-8
24-318P	BELDEN 8281	3 pc. BNC & TNC	.310, .065	99-MC-3
24-321P	RG-6	2 pc. BNC & TNC	.385, .320	99-DC-5



- Full cycle ratchet mechanism
- Quick release safety
- Perform both electrical and mechanical crimp
- High quality steel
- Each tool comes complete with crimp die
- Full range +/- Cam adjustment

Precision Ergo Hand Crimp Tool with Dieset

PART NO.	DESCRIPTION	HEX SIZE	HEX WIDTH
24-9961P (Replacement dieset 99-9961)	Pressmaster K Hand crimp tool frame with dieset	.324 (8.22) .264 (6.71) .213 (5.41)	.475 (12.06) .475 (12.06) .394 (10.00)
24-9962P (Replacement dieset 99-9962)	Pressmaster K Hand crimp tool frame with dieset	.350 (8.89) .288 (5.41) .042 (1.07)	.475 (12.06) .475 (12.06) .080 (2.03)
24-9963P (Replacement dieset 99-9963)	Pressmaster K Hand crimp tool frame with dieset	.255 (6.48) .178 (4.52) .128 (3.25)	.475 (12.06) .475 (12.06) .475 (12.06)



- Longer handles for leverage
- Padded and contoured to fit in hand
- Precision ground die sets
- 50,000 cycle lifespan frame

Standard Series

- Full cycle ratchet mechanism
- Quick release safety
- Perform both electrical and mechanical crimp
- High quality steel
- Each tool comes complete with crimp die

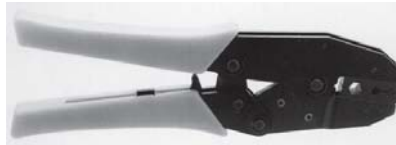

PART NO.	CABLE SIZE	DESCRIPTION	HEX SIZE	REPLACEMENT DIE
24-8789P	RG-58, 59, 62, 58TFE, 59TFE, 62TFE	Crimps BNC-TNC 2 & 3 piece connectors w/ standard crimp rings	.257, .210, .060	99-8789
24-8856P	RG-6, 8, 59, 62	Crimps BNC-TNC 3-piece connectors w/standard crimp ring	.390, .275, .065	99-8856
24-8857P	RG-58/U, 58AU, 174, 139, 185, 188, 316	Crimps BNC-TNC 3-piece connectors w/ standard crimp rings	.235, .128, .065, .042	99-8857
24-8858P	RG-58, 58AU, 59Teflon, 62 Teflon	Crimps BNC-TNC 2 & 3 piece connectors connectors also crimps 1/2"ring F connector	.325, .215, .065	99-8858
24-8859P	RG-59, 62, Belden 8281	Crimps BNC-TNC 2 & 3 piece connectors w/ standard & dual crimp rings	.325, .258, .065	99-8859
24-9858P	RG-58, 59TFE	Crimps BNC-TNC 2-piece connectors	.320, .211	99-9858
24-9958P	RG-58, 58TFE, 59TFE, 141, 142, 223, 400, 303, 55, BELDEN 9907, RG-141	Crimps 3-piece BNC-TNC connectors and Mini-UHF connectors	.213, .067	99-9958
24-9859P	RG-59, 62,	Crimps BNC-TNC 2-piece connectors	.320, .250	99-9859
24-9912P	RG-122, 180, 34M, RG-195, 8218, 174, 188, 179, 187, 316 BELDEN 89907	Crimps 3-piece BNC-TNC connectors	.184, .066	99-9912
24-9959P	RG-59, 62, 450 Proflex, RG-8x	Crimps 3-piece BNC-TNC connectors and Mini-UHF connectors	.255, .065	99-9959

Assembly Tools and Fixtures (108-108X-001 Series)

For Standard Stacking Banana Plugs: .175 (4.44) Across Flats

Quick and easy assembly of standard banana plug .175 (4.44) diameter is possible with the assembly tool and fixtures shown here. Strip wire jacket back 3/4" and feed wire through cross hole of metal contact. Fold stripped wire against metal plug body and slide insulated handle over banana plug body and wires. Insert contact wire into housing. Place into fixture. Push tip of tool into rear of contact. Snap contact into place. Handle of tool is curved to fit hand comfortably. Fixture and tip of tool made from tool steel.



FIXTURE PART NO.
251-0111-003
TOOL PART NO.
251-0115-002

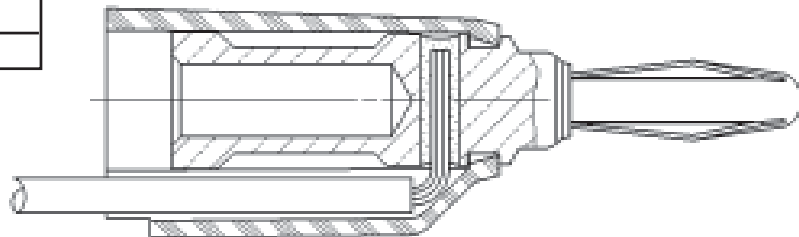

Crimp Tool (105-077X-XXX Series)

For Insulated Standard Small Handle Tip Plugs: .080 (2.00) Diameter and .060 (1.50) Tip Jacks

Quick and easy assembly of standard small handle tip plug .080 (2.00) diameter and .060 (1.50) tip jack is possible with the assembly tool shown. Set the selector to the appropriate wire size, strip wire to .180, insert wire and tip plug in tool, squeeze handles of the tool. A complete and accurate crimp is obtained each and every time, with no partial crimps. A ratchet insures a complete cycle of the tool.

TOOL PART NO.
144-0000-910
ASTRO TOOL PART NO.
615708
MILITARY PART NO.
M22520/1-01

