



60EPU02  
60APU02

## Ultrafast Soft Recovery Diode

### Features

- Ultrafast Recovery
- 175°C Operating Junction Temperature

### Benefits

- Reduced RFI and EMI
- Higher Frequency Operation
- Reduced Snubbing
- Reduced Parts Count

$t_{rr} = 35ns$
$I_{F(AV)} = 60Amp$
$V_R = 200V$

### Description/ Applications


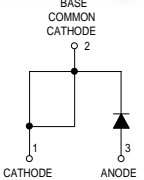

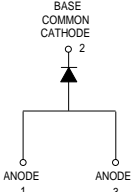
These diodes are optimized to reduce losses and EMI/ RFI in high frequency power conditioning systems. The softness of the recovery eliminates the need for a snubber in most applications. These devices are ideally suited for HF welding, power converters and other applications where switching losses are not significant portion of the total losses.

### Absolute Maximum Ratings

Parameters	Max	Units
$V_R$ Cathode to Anode Voltage	200	V
$I_{F(AV)}$ Continuous Forward Current, $T_C = 127^\circ C$	60	A
$I_{FSM}$ Single Pulse Forward Current, $T_C = 25^\circ C$	800	
$I_{FRM}$ ① Maximum Repetitive Forward Current	120	
$T_J, T_{STG}$ Operating Junction and Storage Temperatures	- 55 to 175	°C

① Square Wave, 20kHz

### Case Styles

<p>60EPU02</p>   <p>TO-247AC (Modified)</p>	<p>60APU02</p>   <p>TO-247AC</p>
---	---

**Electrical Characteristics @ T<sub>J</sub> = 25°C (unless otherwise specified)**

Parameters	Min	Typ	Max	Units	Test Conditions
V <sub>BR</sub> , V <sub>r</sub> Breakdown Voltage, Blocking Voltage	200	-	-	V	I <sub>R</sub> = 100μA
V <sub>F</sub> Forward Voltage	-	0.98	1.08	V	I <sub>F</sub> = 60A
	-	0.81	0.88	V	I <sub>F</sub> = 60A, T <sub>J</sub> = 175°C
I <sub>R</sub> Reverse Leakage Current	-	-	50	μA	V <sub>R</sub> = V <sub>R</sub> Rated
	-	-	2	mA	T <sub>J</sub> = 150°C, V <sub>R</sub> = V <sub>R</sub> Rated
C <sub>T</sub> Junction Capacitance	-	87	-	pF	V <sub>R</sub> = 200V
L <sub>S</sub> Series Inductance	-	8.0	-	nH	Measured lead to lead 5mm from package body

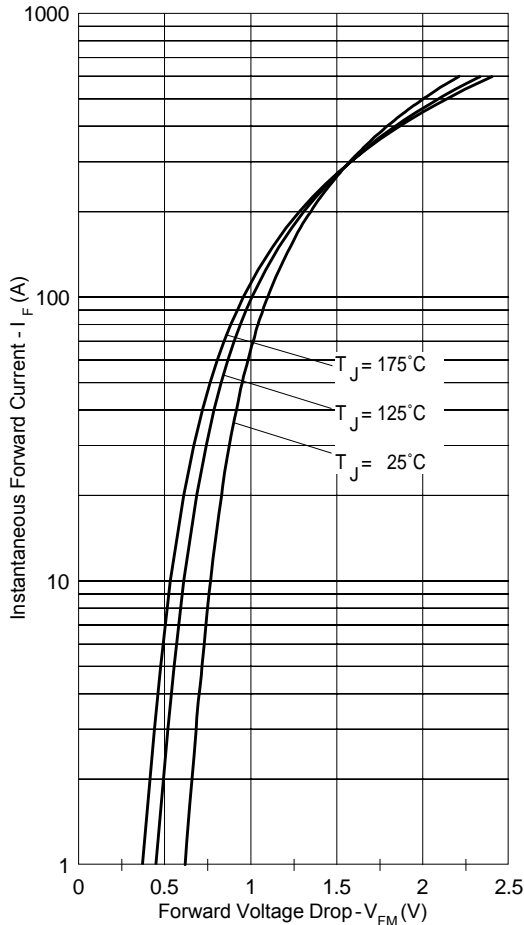
**Dynamic Recovery Characteristics @ T<sub>J</sub> = 25°C (unless otherwise specified)**

Parameters	Min	Typ	Max	Units	Test Conditions	
t <sub>rr</sub> Reverse Recovery Time	-	-	35	ns	I <sub>F</sub> = 1.0A, di <sub>F</sub> /dt = 200A/μs, V <sub>R</sub> = 30V	
	-	28	-		T <sub>J</sub> = 25°C	I <sub>F</sub> = 60A V <sub>R</sub> = 160V di <sub>F</sub> /dt = 200A/μs
	-	50	-		T <sub>J</sub> = 125°C	
I <sub>RRM</sub> Peak Recovery Current	-	4	-	A	T <sub>J</sub> = 25°C	
	-	8	-		T <sub>J</sub> = 125°C	
Q <sub>rr</sub> Reverse Recovery Charge	-	59	-	nC	T <sub>J</sub> = 25°C	
	-	220	-		T <sub>J</sub> = 125°C	

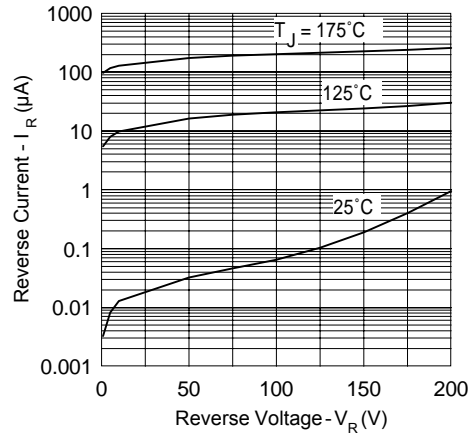
**Thermal - Mechanical Characteristics**

Parameters	Min	Typ	Max	Units
R <sub>thJC</sub> Thermal Resistance, Junction to Case			0.70	K/W
R <sub>thCS</sub> ② Thermal Resistance, Case to Heatsink		0.2		
Wt Weight		5.5		g
		0.2		(oz)
T Mounting Torque			1.2	N*m

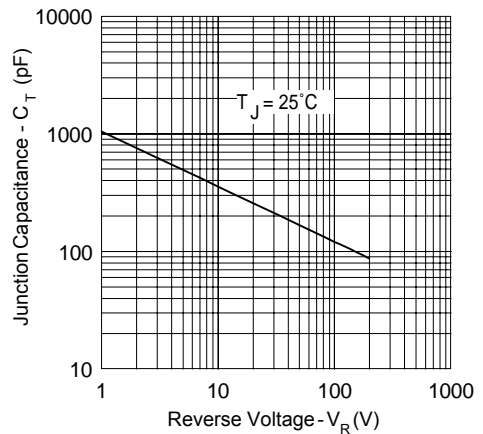
② Mounting Surface, Flat, Smooth and Greased



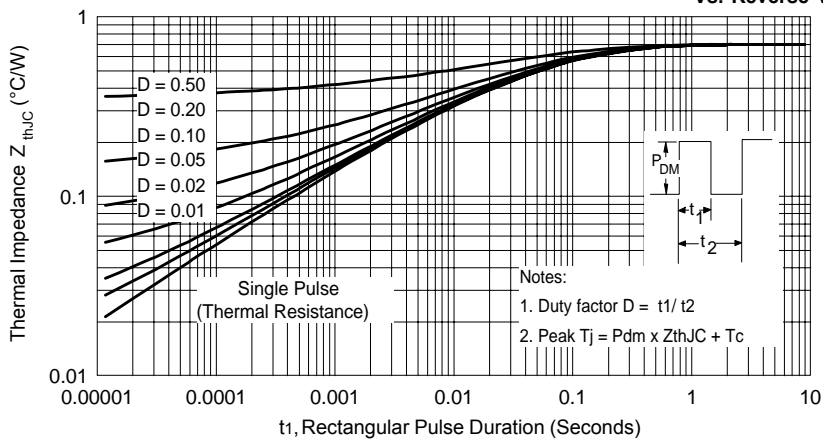
**Fig. 1 - Typical Forward Voltage Drop Characteristics**



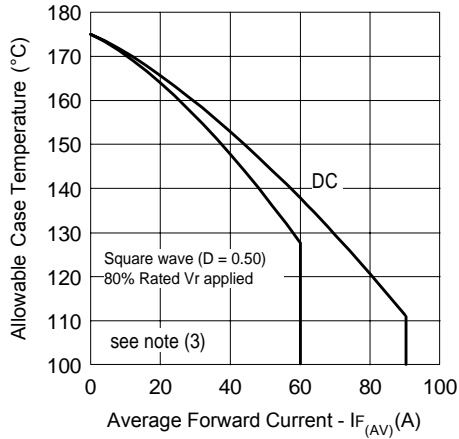
**Fig. 2 - Typical Values Of Reverse Current Vs. Reverse Voltage**



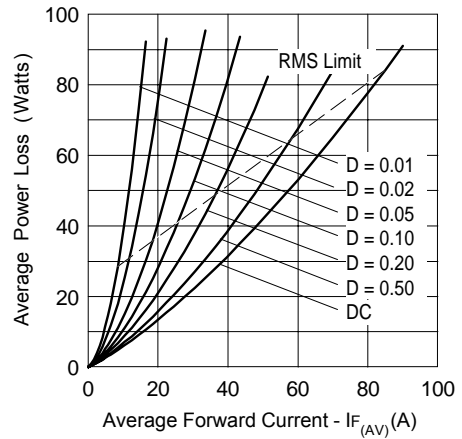
**Fig. 3 - Typical Junction Capacitance Vs. Reverse Voltage**



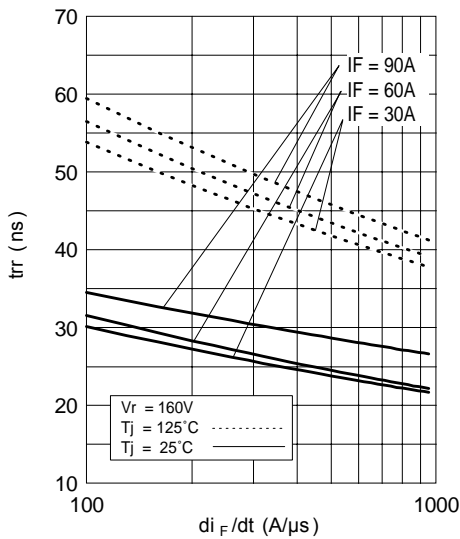
**Fig. 4 - Max. Thermal Impedance  $Z_{thJC}$  Characteristics**



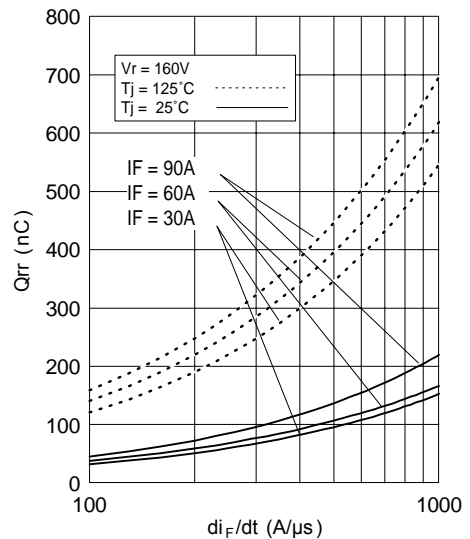
**Fig. 5 - Max. Allowable Case Temperature Vs. Average Forward Current**



**Fig. 6 - Forward Power Loss Characteristics**

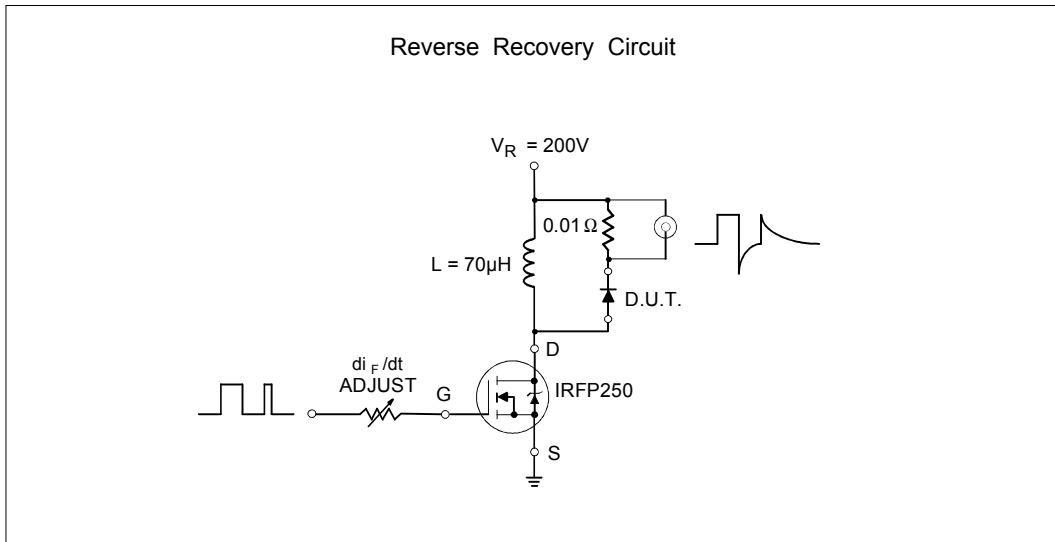


**Fig. 7 - Typical Reverse Recovery time vs. di\_F/dt**

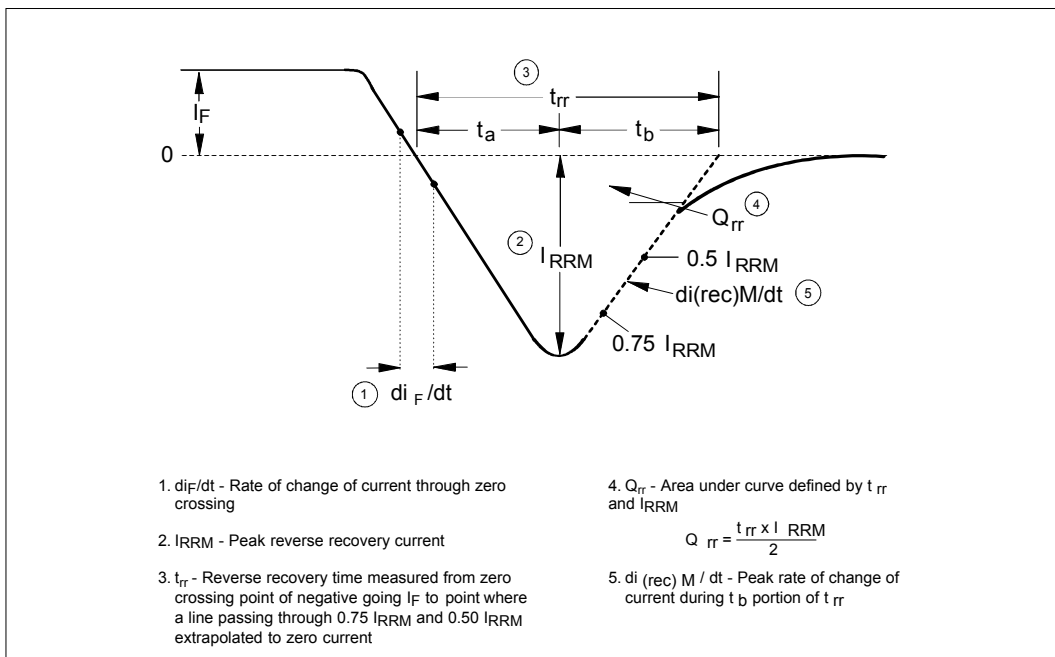


**Fig. 8 - Typical Stored Charge vs. di\_F/dt**

(3) Formula used:  $T_c = T_j - (Pd + Pd_{REV}) \times R_{thJC}$ ;  
 $Pd = \text{Forward Power Loss} = I_{F(AV)} \times V_{FM} @ (I_{F(AV)} / D)$  (see Fig. 6);  
 $Pd_{REV} = \text{Inverse Power Loss} = V_{R1} \times I_R (1 - D); I_R @ V_{R1} = 80\% \text{ rated } V_R$

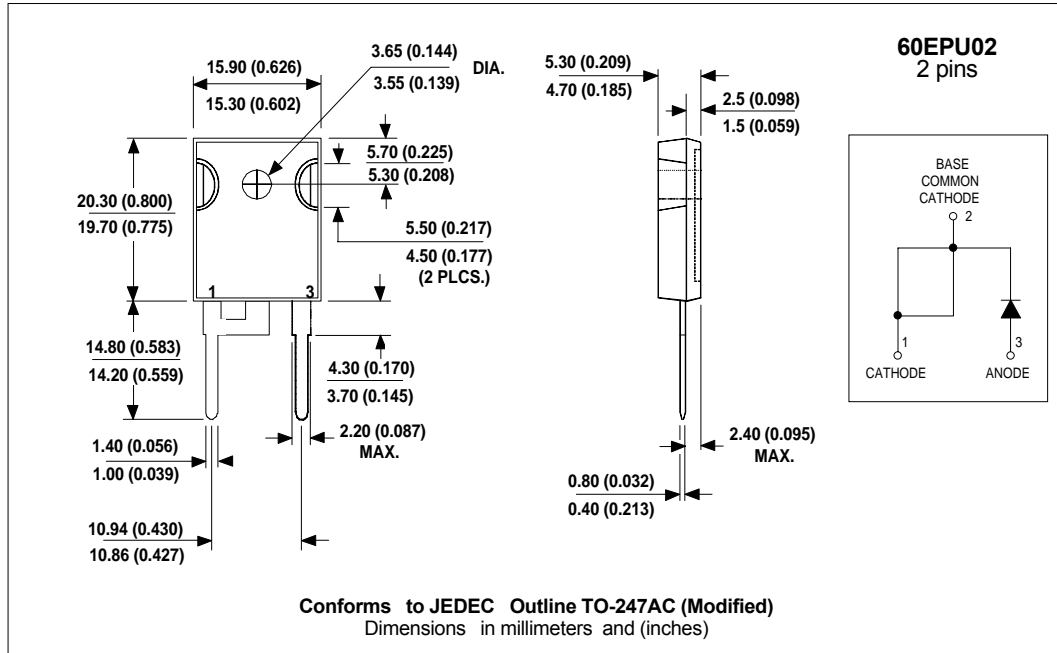


**Fig. 9- Reverse Recovery Parameter Test Circuit**

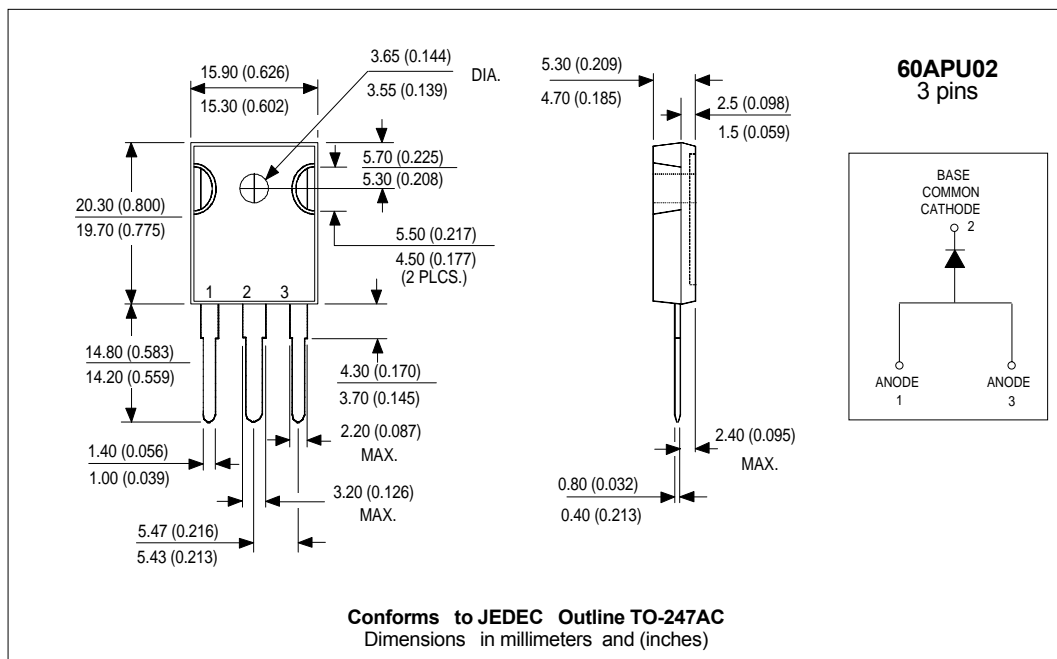


**Fig. 10 - Reverse Recovery Waveform and Definitions**

Outline Table



Outline Table



### Ordering Information Table

Device Code				
<b>60</b>	<b>E</b>	<b>P</b>	<b>U</b>	<b>02</b>
①	②	③	④	⑤
<b>1</b>	-	Current Rating	(60 = 60A)	
<b>2</b>	-	Single Diode:	E = Single Diode A = Single Diode (3 pins)	
<b>3</b>	-	TO-247AC (Modified)		
<b>4</b>	-	Ultrafast Recovery		
<b>5</b>	-	Voltage Rating	(02 = 200V)	

Data and specifications subject to change without notice.  
This product has been designed and qualified for Industrial Level.  
Qualification Standards can be found on IR's Web site.

International  
**IR** Rectifier

**IR WORLD HEADQUARTERS:** 233 Kansas St., El Segundo, California 90245, USA Tel: (310) 252-7105  
TAC Fax: (310) 252-7309  
05/01



## Notice

The products described herein were acquired by Vishay Intertechnology, Inc., as part of its acquisition of International Rectifier's Power Control Systems (PCS) business, which closed in April 2007. Specifications of the products displayed herein are pending review by Vishay and are subject to the terms and conditions shown below.

Specifications of the products displayed herein are subject to change without notice. Vishay Intertechnology, Inc., or anyone on its behalf, assumes no responsibility or liability for any errors or inaccuracies.

Information contained herein is intended to provide a product description only. No license, express or implied, by estoppel or otherwise, to any intellectual property rights is granted by this document. Except as provided in Vishay's terms and conditions of sale for such products, Vishay assumes no liability whatsoever, and disclaims any express or implied warranty, relating to sale and/or use of Vishay products including liability or warranties relating to fitness for a particular purpose, merchantability, or infringement of any patent, copyright, or other intellectual property right.

The products shown herein are not designed for use in medical, life-saving, or life-sustaining applications. Customers using or selling these products for use in such applications do so at their own risk and agree to fully indemnify Vishay for any damages resulting from such improper use or sale.

International Rectifier®, IR®, the IR logo, HEXFET®, HEXSense®, HEXDIP®, DOL®, INTERO®, and POWIRTRAIN® are registered trademarks of International Rectifier Corporation in the U.S. and other countries. All other product names noted herein may be trademarks of their respective owners.