

PART NUMBER  
10118192-0001LF

Tous droits strictement reserves. Reproduction ou communication a des tiers interdite sous quelque forme que ce soit sans autorisation écrite du propriétaire. Propriete de c FCI. Droits de reproduction FCI.

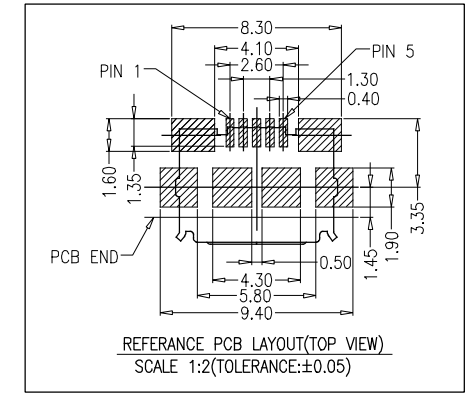

All rights strictly reserved. Reproduction or issue to third parties in any form whatever is not permitted without written authority from the proprietor. Property of FCI. Copyright FCI.

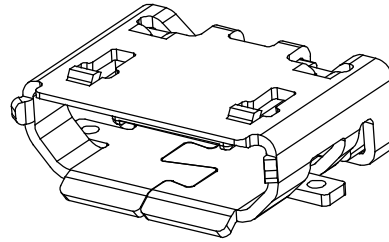
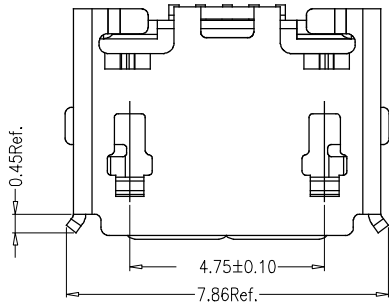

REFERENCE PCB LAYOUT(TOP VIEW)  
SCALE 1:2(TOLERANCE:±0.05)

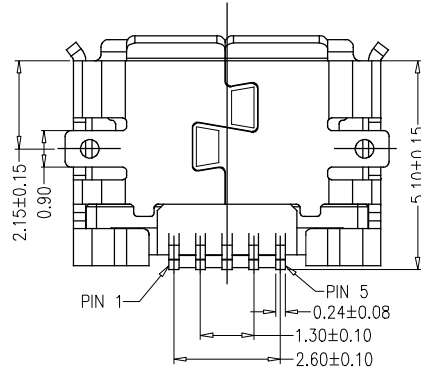
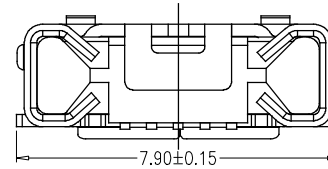
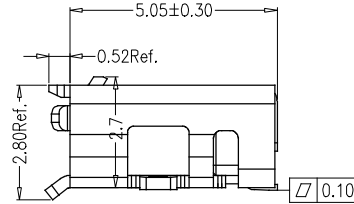
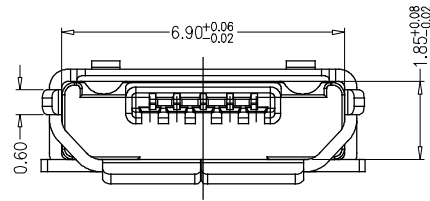

-NOTE-

- Product meets USB 2.0 requirement.
- Coplanarity:  
Solder tails: 0.08mm maximum.  
Metal tabs: 0.10mm maximum.
- The "LF" is meant lead free and can withstand expose to 260° C peak temperature for 10 seconds in IR reflow process.

Item	Title	Material	Finish
1	Shell	Stainless Steel	Matte Tin 80u" min.
2	Terminal	Copper Alloy	Mating Area: 30u" Gold Solder Tails: G/F.
3	InsertMolding	Thermoplastic	UL94V-0, Black

mat'l. code				tolerances unless otherwise specified		CUSTOMER COPY				www.fciconnect.com		
ltr	ecn no	dr	date	linear	.X ± 0.38	projection		title				
A		J.H	5/12/11		.XX ± 0.25			MICRO USB B TYPE RECEPTACLE				
					.XXX ± 0.10			product family USB				
				angles	0' ±2'	MM		size		code		
				dr	JASON HSU			5/12/11	10118192		TWN	
				enr	JASON HSU			5/12/11	1 of 1			
				chr	GARY HSIEH	5/12/11	scale					
				appd	JOSEPH HSIA	5/12/11	5:1					
sheet index	revision sheet	A	1									

cage code